

W-BEAM GUARDRAIL REPAIR AND MAINTENANCE

A Guide for
Street and Highway Maintenance Personnel

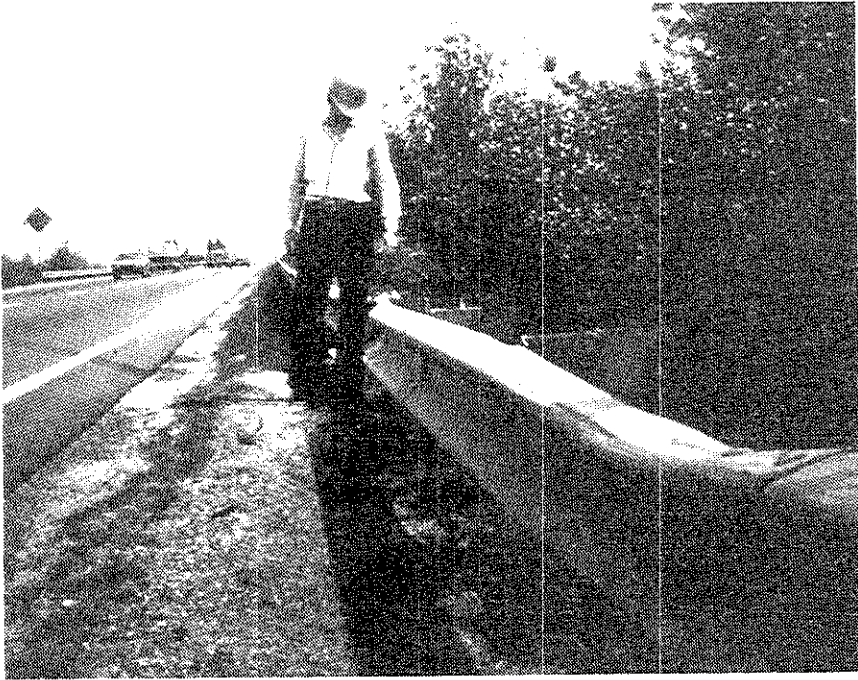

U.S. Department
of Transportation

**Federal Highway
Administration**

FHWA-RT-90-001

Prepared under the Rural Transportation
Assistance Program Project 70 by the
Technology Transfer Center,
Iowa State University,
Ames, Iowa 50011

Notice

This document is disseminated under the sponsorship of the Department of Transportation in the interest of information exchange. The United States Government assumes no liability for its contents or use thereof.

The contents of this report reflect the views of the authors, who are responsible for the facts and the accuracy of the data presented herein. The contents do not necessarily reflect the official policy of the Department of Transportation.

This report does not constitute a manual, handbook, standard, specification, or regulation.

The United States Government does not endorse products or manufacturers. Trademarks or manufacturer's names appear herein only because they are considered essential to the object of this document.

TABLE OF CONTENTS

	page
I. Guardrail Safety	1
Why Guardrail Repair and Maintenance are Needed	1
Some Tips to Increase Safety	1
II. Site Review	3
Deciding What Needs to be Done	3
Removal of Damaged Materials and Cleanup	8
Placing Temporary Warnings and Markers	9
III. Estimating Parts and Materials for Rail on Wood Post	10
IV. Estimating Parts and Materials for Rail on Steel Post	12
V. Equipment and Tools	14
Equipment and Function	14
Tools for Use in Repair	15
VI. Manpower: Crew Size and Time Needed	20
Estimating Time Required for Repair	20
Estimating Crew Size	21
VII. Repair Sequence Guidelines	22
VIII. Traffic Control	28
Typical Traffic Control for Lane Closure	28
Typical Traffic Control for Shoulder Closure	30
IX. Records of Repairs	32
X. Maintenance Tips	33

I. GUARDRAIL SAFETY

Why Guardrail Repair and Maintenance is Needed

- Road was designed and constructed to require guardrail.

The location of posts, bridge piers, steep ditch slopes, or some other feature of the road creates a hazard to drivers who get off their lane. When we have a road section that engineers have decided needs a guardrail to make travel safe enough, it is important that we maintain that guardrail. We must also repair that guardrail so it can protect people who happen to run off the road. In most states we have a duty, by law, to maintain the road in a safe condition as the original design intended.

- Maintenance workers are closest to the problem.

Maintenance workers are the front-line troops to keep the road safe just as much as any state trooper. They will likely be among the first persons to see any damage who understand the importance of a guardrail in keeping a road safe. Their actions will be important in preserving road safety.

- Good maintenance reduces lawsuits against highway agencies.

Keeping track of the damage to guardrails, making repairs quickly, and recording the repairs made will help limit lawsuits. The claims made will more likely be fair if good maintenance is done.

Some Tips to Increase Safety

- W-beam rail sections must not be badly bent out of shape.
- Bolts must be the right size and be tight.
- Wooden posts must not be loose, broken, or rotted.
- Steel posts must not be bent or pushed off line so badly that a vehicle hitting the rail will slide off the road.
- Rail sections must be blocked out away from the posts.
- Road or shoulder surface under the rail needs to be free of holes and eroded ruts that a wheel can drop into.
- General line of the guardrail should be a smooth path.
- Guardrail needs to be at the correct height from the ground.

NOTES

II. SITE REVIEW

Deciding What Needs to be Done

- Define the extent (or severity) of damage.

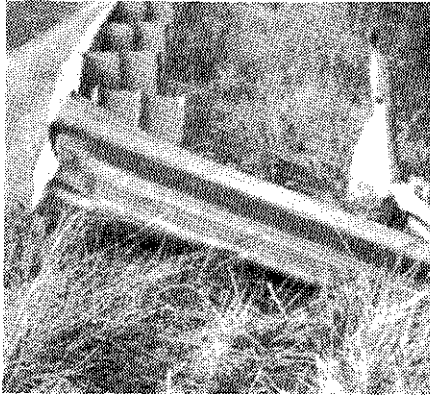

Guardrail damage is so bad that it no longer functions and may itself be a hazard to motorists.

1. The rail beam is pulled completely apart.
2. Three or more posts are broken off or are no longer attached to rail.
3. Rail beam is bent or pushed more than 18 inches out of line.

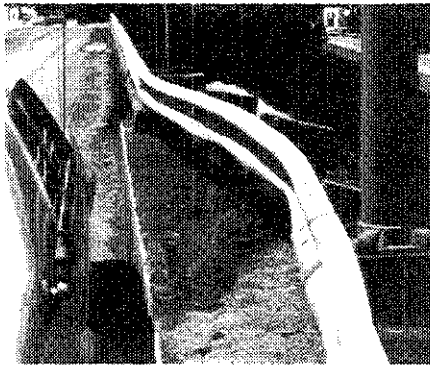

Guardrail is obviously damaged but may still work for most traffic conditions.

1. Even though badly bent or crushed, rail beam is not separated anywhere.
2. Two or fewer posts are broken off or separated from the rail beam.
3. Rail beam is bent or pushed out of line less than 12 inches.

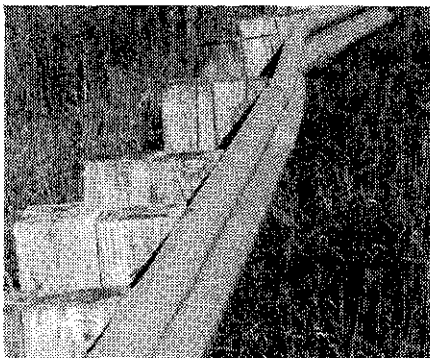

Guardrail damage is minor. It will continue to work.

1. Rail beam may be crushed or flattened but is not cut.
2. No posts are broken off or separated from rail beam.
3. Rail beam is bent or pushed out of line less than six inches.

● **Some examples and comments.**

Guardrail damage is so bad that it no longer functions.



1. Several rail sections have torn out. Three posts have been broken and several are pushed more than 1.5 feet off line. A vehicle hitting this spot now could go through the hole or be speared on the end of the remaining rail.

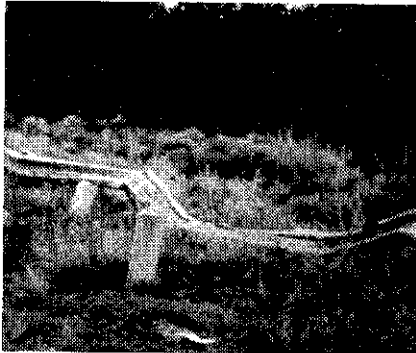

2. One post is broken off. Two other posts are badly pushed off line and the rail beam is torn loose. A second vehicle hitting this might be rolled over by the posts and the mangled rail or it might pass over the rail and hit a more hazardous object.

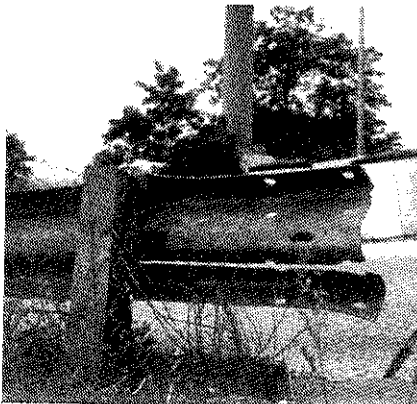

3. Rail beam connection has broken. The rail beam is split back to the nearest post and the connection to the end of the bridge is gone. This type of damage can appear minor and unimportant, but it is serious for the vehicle crashing into the beam. Such damage needs to be fixed soon.

Guardrail is obviously damaged but may still work for most traffic conditions.

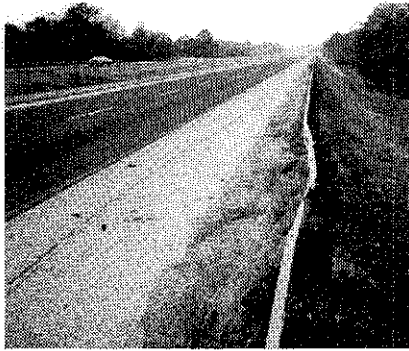

1. A crash into a long run of guardrail has pushed a few posts off line, flattened the rail in one spot, and loosened the connection to one post. The remaining rail length on each side of this damage area will provide protection to crashing vehicles until this spot can be scheduled to be fixed.

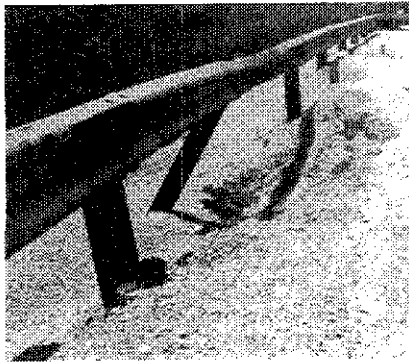

2. A crash into this rail has crushed the rail some and has pushed the supporting base of one post out. This post no longer provides much support, but dumping some aggregate material into the hole left by the crash and leveling it out to the proper height will permit this rail to work until permanent repairs can be made.

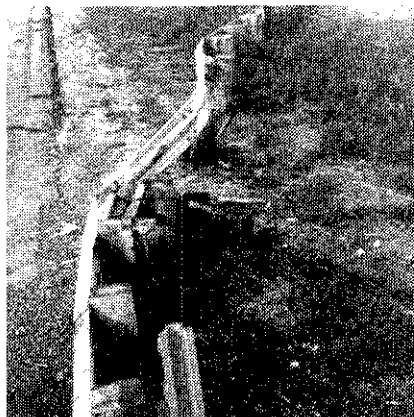

3. This guardrail has taken a solid sliding hit that broke two wood posts and pushed one other post off line. The rail beam is bent and pocketed but is still intact with no broken splices. A vehicle crashing into it will have a more severe crash than the one which caused this damage, but the guardrail will still keep vehicles away from more severe hazards until it can be fully repaired.

Guardrail damage is minor. It will continue to work.

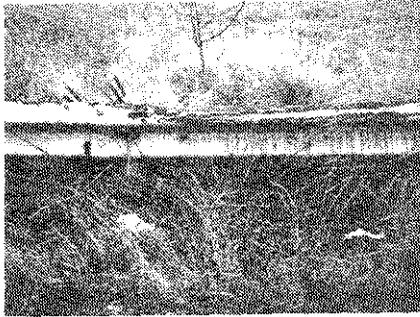

1. The guardrail beam has been crushed down in the top by a large farm machine or a piece of construction equipment and is badly corroded. Even though it is rusty and looks terrible, the beam will still work to hold a vehicle away from the hazard behind it.

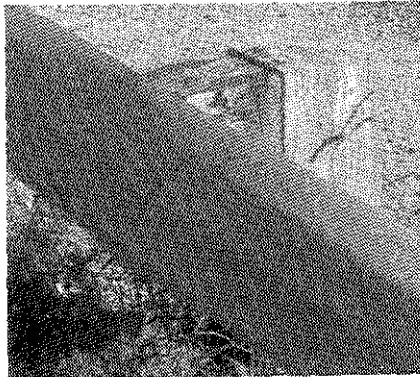

2. The guardrail has been dented from a minor collision. A guardrail may have these types of dings all along its length and still be very safe and useful. It may not look pretty, but it still works.

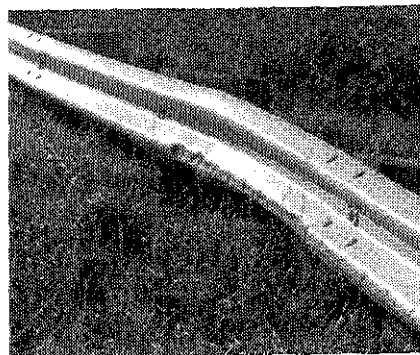

3. The guardrail has minor crush in the beam and has been pushed off line a little. One or more of the posts have been pushed slightly off line. The guardrail may look beat up, but it will still keep a vehicle on the road in most crashes if it is still connected and if the top of the rail is at least 24 inches above the ground.

- Deciding what to do about the damage.

When the guardrail damage is so bad that it no longer functions and may itself be a hazard to motorists,

1. Clear any debris from the traffic lanes and shoulder;
2. Put out temporary warning devices such as vertical panels or small barricades to warn traffic away if it cannot be fixed immediately;
3. Figure out what materials and equipment are needed to fix it, and get the repair job started as soon as possible.

When the guardrail is obviously damaged but may still work for most traffic conditions,

1. Make a good inspection of the damage to be certain it will be acceptable for awhile;
2. Make a damage inspection report and repair request for parts and equipment;
3. Schedule the repair along with other scheduled work;
4. Check the damage site frequently to see if it has been hit again or damaged worse than first thought. Such damage may make it important to repair the damage more quickly.

When the guardrail damage is minor and the barrier will continue to work,

1. Decide if the damage is bad enough to be worth fixing at all;
2. Decide how much is to be repaired if any repair is to be made to the minor damage;
3. Report what is to be done for any repair thought to be needed, and schedule the repair when convenient to the work schedule.

Removal of Damaged Materials and Cleanup

- Clean debris from traveled lanes and shoulders.

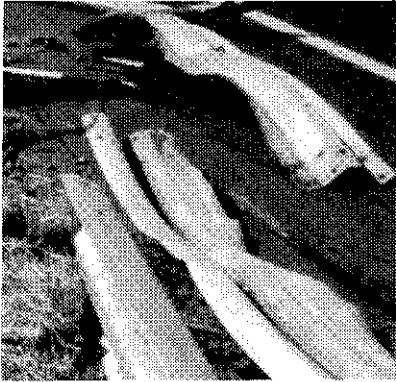

Remove all broken guardrail and other loose parts that are on the lanes or shoulders where a person might drive into them. This includes all vehicle debris left from the collision. If this material cannot be hauled away, then place it at least 5 feet behind the remaining guardrail for collection later. Get this debris off the roadway. Leaving it on the road is dangerous.

- Remove guardrail parts that are still in place but are hazardous to traffic.

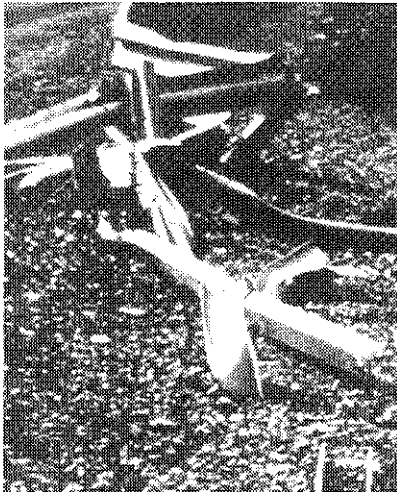

After a vehicle hits the guardrail, a section of W-beam rail may still be attached to posts but twisted so it sticks out. It may snag or spear any vehicle that hits it. Any damaged rail section that may spear a vehicle should be cut out. Steel posts may be still standing after a hit but the rail section is stripped off. These post stubs can be a hazard. If your equipment is able, pull such posts immediately or push them over far enough for a small car to ride over the post.

- Smooth out deep gouges in shoulder.



If the collision left any gouges or trenches in the shoulder more than 6 to 8 inches deep, smooth them out so a small car can easily cross them.

Placing Temporary Warnings and Markers

- Is the guardrail still functional? Is the damage minor or will the guardrail still work for most traffic conditions?

Yes Then temporary warning devices should not be needed.

No When the guardrail can no longer function and may itself be a hazard to motorists, then place temporary warnings and markers until repairs are made.

Further checks when placing temporary warnings and markers:

- Is the shoulder narrow or the guardrail within 6 feet of the outside edge of the traveled lane?

Yes Then vertical panels or some other small delineation device is suggested if there is room for traffic to pass by. Space may be so limited that attaching reflectors to the rail may be all that can be done to mark the area.

No Then safety barrels, Type II barricades, or vertical panels may be used to mark the danger and warn drivers away from it.

- Will traffic be exposed to the damage area over night or during hours of darkness?

Yes Then consider using flashers on the warning devices and markers.

No Then flashers are not needed on the warning devices and markers.

III. ESTIMATING PARTS AND MATERIALS FOR RAIL ON WOOD POST

Typical Standard Guardrail W-Beam on Blocked-out Wood Posts.

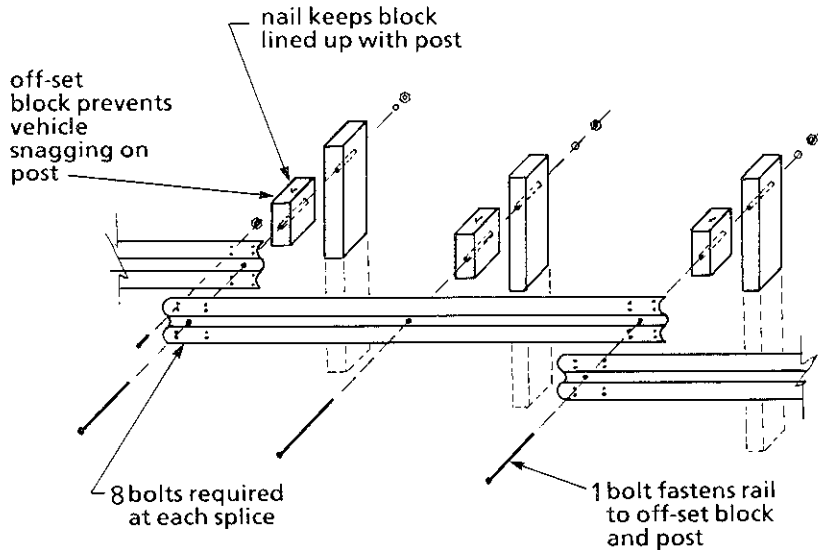

Typical elements of the W-beam guardrail on blocked-out wood posts.

- * 12'-6" galvanized steel W-beam rail sections.
- * Eight each $5/8" \times 1-1/4"$ galvanized button head (carriage) bolts with recess nuts for each splice in the rail.
- * One each $5/8" \times 18"$ long galvanized button head (carriage) bolt with washer and recess nut for fastening rail to wooden post with offset wooden block.
- * One each $6" \times 8" \times 1'-2"$ treated wood offset block to space the rail away from the post.
- * $6" \times 8" \times 6'-0"$ treated wood posts.
- * One each 10d galvanized nail to keep offset block lined up to post.

**W-Beam on Blocked-out Wood Posts
CHECK LIST OF MATERIALS FOR REPAIR**

Item	Compute	Number needed
W-Beam galvanized steel rail section 12'-6" long punched @3'-1.5"	Tally # of damaged sections	
5/8"× 18" long bolts with nuts for connecting rail to post and block	(# sections X 2) + 1	
5/8"× 1.25' long bolts with nuts for rail splice connections	(# sections X 8) + 8	
6"× 8× 6'-0" wood treated post	(# sections X 2) + 1	
6"× 8"× 1'-2" wood spacer block	same as # wood posts	
10d galvanized nails (one per spacer block)	# of spacer blocks	

OTHER NONSTANDARD ITEMS NEEDED

Note: Guardrail designs change over the years. When sections of older guardrail are repaired they should be replaced in the same way they were built originally. Parts and materials may be different from newer guardrail designs.

Item	Compute	Number needed

IV. ESTIMATING PARTS AND MATERIALS FOR RAIL ON STEEL POST

Typical Standard Guardrail W-Beam on Blocked-out Steel Posts.

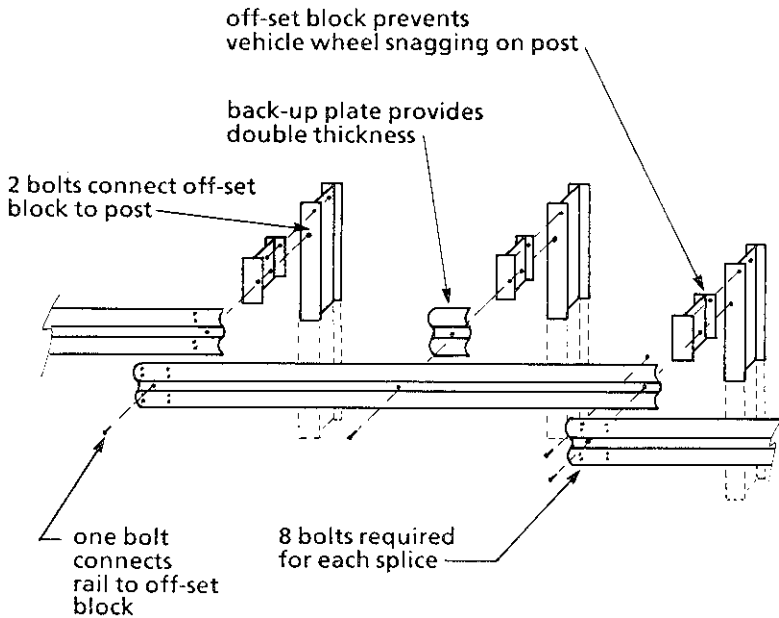

Typical elements of the W-beam guardrail on blocked-out wood posts.

- * 12'-6" steel W-beam rail sections.
- * Eight each $5/8" \times 1-1/4"$ button head (carriage) bolts with recess nuts for each splice in the rail.
- * One each $5/16" \times 1-1/2"$ long galvanized hex bolt and nut for fastening W-beam to steel post offset block.
- * One each $6" \times 9"$ galvanized steel post offset block for each post.
- * Two each $5/8" \times 1-1/2"$ galvanized hex head bolts and nuts for fastening steel offset block to steel posts.
- * One each $12" \times 1'-1/4"$ galvanized W-beam backup plate at intermediate steel post locations for placing behind rail where no rail splice occurs.
- * $W6 \times 9.0 \times 6'-0"$ steel post.

W-Beam on Blocked-out Steel Posts CHECK LIST OF MATERIALS FOR REPAIR

Item	Compute	Number needed
W-Beam galvanized steel rail section 12'-6" long punched @3'-1.5'	Tally # of damaged sections	
W-Beam galvanized steel rail section backup plate for post between splices	same as # of sections	
5/8" × 1.25" long bolts with nuts for rail splice connections	(# sections X 8) + 8	
W6 × 9.0 × 6'-0" Structural shape galvanized steel posts	(# sections X 2) + 1	
W6 × 9.0 Structural shape galvanized steel off-set blocks	(# sections X 2) + 1	
5/8" × 1.5" long bolts with nuts	(# sections X 4) + 2	
5/16" × 1.5" long bolts with nuts	(# sections X 2) + 1	

OTHER NONSTANDARD ITEMS NEEDED

Note: Guardrail designs change over the years. When sections of older guardrail are repaired they should be replaced in the same way they were built originally. Parts and materials may be different from newer guardrail designs.

Item	Compute	Number needed

V. EQUIPMENT AND TOOLS

Equipment and Function

- Light truck (2 1/2-ton nominal rating)



The truck should have a yellow rotating strobe light for warning traffic to stay clear of the work area. Use the truck to haul repair parts to the site, to haul tools, and to haul damaged parts away. A truck with a chain can often be used to pull or straighten steel posts. Use it to haul traffic control devices and markers.

- Front-end loader

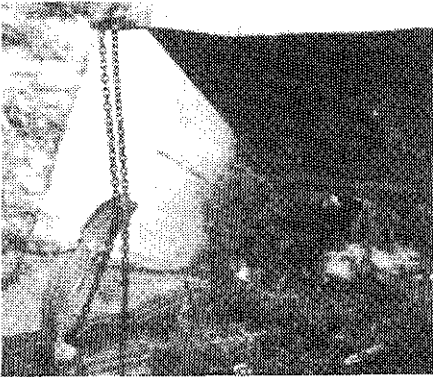

A front-end loader can be useful in reshaping the shoulder or foreslope area if rough spots remain after the repair is completed. By using a chain with the bucket, broken posts can be pulled.

- Power post driver

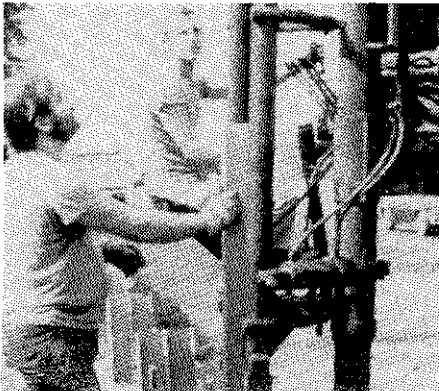

A power post driver can speed up the repair operation if a large number of posts have to be replaced (five or more). Safety to traffic and safety for workers is improved when the repair work is done quickly.

Tools for Use in Repair

- Suggested minimum tools to take to repair site

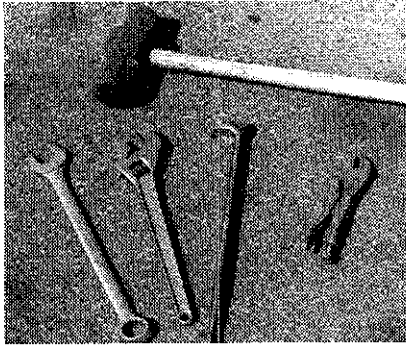

Combination box-end and open-end wrench in 5/8" and 5/16"
Drift pins
Vise-grip pliers
Sledge hammer
Adjustable (crescent) wrench

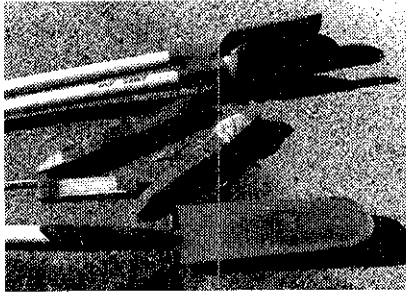

Shovel
Posthole digger
String line
Wood stakes or rebar
6'-3" measuring stick or folding wood ruler

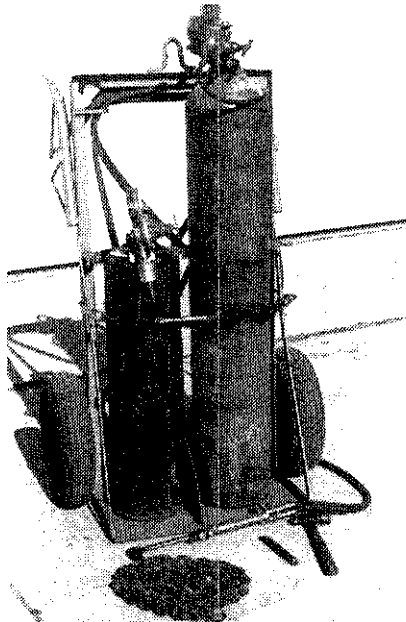

Heavy chain
Chisel and hammer
Oxy-acetylene torch
(Maybe a power post driver if a large number of posts are to be driven)

ALL PERSONNEL SHOULD HAVE LEATHER GLOVES, HARD HATS, AND SAFETY VESTS.

- Complete tool list for a major repair job, with special tool sets for guardrail repair

High Use Items:

One 0.5-inch electric impact wrench	<i>Useful in removing bolts in rail splices in order to remove damaged rail sections. Useful in tightening bolts to proper snug fit in part replacement.</i>
One 0.5-inch drive 1.25-inch deep impact socket	
One 0.5-inch drive impact swivel	
One set of 0.5-inch drive sockets in 1 3/8-, 1 5/16-, 1 1/16-, and 7/8-inch sizes	
One 1 5/8-inch end wrench	
One 1 1/4-inch end wrench	
One 12-inch adjustable (Crescent) wrench	
One 0.5-inch drive ratchet	
One 0.5-inch × 3-inch drive extension	
Two rolling head bars	
Three punches of various sizes	
One blacksmith hammer	
One ball peen hammer (24-oz.)	
One pair snap-on pliers (vise grips)	<i>Useful in holding rail sections and other metal parts while bolting or joining them.</i>
One pair channel-lock pliers	
Two 12-inch C-clamps	
One 12-foot steel tape	<i>For relocating posts and checking the line and height of the rail.</i>
One 50-foot steel tape	
One 6-foot stick rule graduated in inches and 0.01 inch	
One 100-foot string line	
One claw hammer (16-oz.)	<i>For driving and pulling toenails in wooden post blockouts</i>
One 4-foot carpenter's level	<i>For plumbing posts</i>

High Use Items (continued):

One 3/4-inch electric drill
One set drill bits including 9/16, 5/8,
3/4, and 1 inch
One 1/2-inch electric hammer drill
One 3/4-inch wood bit
Two 3/8-inch wood bits

For drilling holes in rail or posts as needed to fit rail and posts together and to make rail splices.

One 110-volt gasoline generator
One 50-foot extension cord
One 25-foot extension cord

To provide electric power for drills and other electric tools.

Two metal files (mill bastard, 12 inches)
One reamer tapered 0 to 1.5 inches

For smoothing cut edges and drilled holes.

One sand shovel
One tamper
One posthole digger
Three augers in sizes 12 inches, 18 inches, and 24 inches

Useful in resetting posts and reshaping or digging holes for posts.

One bolt puller

For removing stuck bolts.

One gasoline powered chain saw

For cutting wooden posts.

One knuckle boom

For power assist in moving heavy items.

Five chains of various lengths
One 8-pound sledge hammer
Three 5/16-inch by 6-foot steel cables

For pulling posts and other parts with trucks and heavy equipment. For heavy straightening.

Occasional Use Items:

Two diamond core drills 1 inch \times 16 inches
Two 9-inch core drill extensions
One electric cutoff saw
One 3/4-inch concrete bit
One 1-inch concrete bit

For drilling holes and attaching the rail beam to concrete bridge abutments or bridge railing.

Occasional Use Items (continued):

One 1/2-inch drill press adapted to boom	<i>For field drilling of precisely positioned holes.</i>
One set of post-lifting tongs	<i>Attaching posts to lifting devices.</i>
One set of end wrenches, sizes 1/4 inch through 1 1/4 inches	<i>For doing smaller tasks in making splices and attachments or in field repairs to equipment system.</i>
One set of drill bits, sizes 1/16 inch through 1/2 inch	
One set of 1/2-inch drive sockets, sizes 7/16 inch through 1 1/4 inch	
One 1.5-ton come-a-long	<i>Hauling long rail sections.</i>
Two 3-gallon gasoline cans	<i>Fuel for generator and chain saw.</i>
One pick	<i>For digging out broken wooden posts.</i>
One 100-foot tape graduated in 0.01 foot	<i>For easier long measurements in laying out guardrail replacement.</i>
Four chain binders of various sizes	<i>Useful in attaching chain to objects.</i>
One 14-inch pipe wrench	<i>For heavy-duty odd-size work for which visegrips or a 12-inch adjustable wrench is not large enough.</i>
One 18-inch pipe wrench	
One 3/4-inch drive by 16-inch breaker bar	<i>Separating stuck parts.</i>

Convenience Use Items:

One pneumatic hammer drill

Assist in drilling holes in concrete culvert or bridge wingwalls and other rail anchorages.

One power tamper

Assist in setting posts and reshaping earth around rail line on large repair jobs.

Both of these items are time savers for big repair jobs.

VI. MANPOWER: CREW SIZE AND TIME NEEDED

Estimating Time Required for Repair

● **General guidelines**

1. Include travel time to and from the repair site if this is a maintenance activity scheduled from a central garage.
2. Plan on it taking about 30 to 45 minutes to place the traffic control devices. It will take about the same time to gather the control devices up after the repair work is completed.
3. Allow 30 minutes for final inspection of the guardrail after finishing the repair and for recording the repair job.
4. The actual time needed to make ANY repair depends on the experience and skill of the crew. The number of workers for the job and the amount of power-assisted tools available will affect the time required also.

● **Repairing "cosmetic" damage to guardrail installations**

If your agency wants you to repair the very minor type of damage mentioned earlier in this handbook, the actual repair (which may only be painting or minor straightening of a dented rail) should not require more than 30 minutes to one hour of time.

● **Repairing damage that still permits the guardrail to function**

When the inspection of the damage at the site indicates

- * only a couple of posts are broken
- * only a couple of posts are pushed badly off line
- * a rail is bent out of line less than 18 inches
- * only one rail splice is broken
- * only one rail section is torn out

or other conditions exist that permit routine scheduling of the repair (rather than emergency repair), the following time estimate guideline is suggested. Plan for one to two hours of repair time plus traffic control, inspection, and recording.

● **Repairing major damage that requires prompt attention**

When the guardrail damage is extensive, such as five or more posts are knocked out or several rail beam sections are broken, plan on a 1/2-day time requirement including the traffic control setup, inspection, and recording.

IF YOUR MAINTENANCE MANAGEMENT SYSTEM GIVES A MORE DETAILED TIME BREAKDOWN, USE THAT TO ESTIMATE TIME.

Estimating Crew Size

● Traffic control crew needs

1. If no person is to be assigned to flagging traffic through the repair work zone, then no additional workers are needed. The persons repairing the rail can place and gather up the traffic control devices. There can be situations causing short-term encroachment on the road to move equipment or to make brief repairs. Provide warning to traffic in such cases.
2. One worker is needed as a flagger when the traffic cones or temporary barricades around the repair site closes the road or street down to alternating one-way traffic **IF ONE FLAGGER CAN CLEARLY SEE TRAFFIC APPROACHING THE REPAIR SITE FROM BOTH DIRECTIONS AND THE FLAGGER SIGNAL CAN BE SEEN BY DRIVERS WELL IN ADVANCE OF THE REQUIRED STOP POINT.**
3. Two workers need to be assigned as flaggers for any other work zone conditions where the traffic cones or barricades create alternating one-way traffic flow around the repair.

● Workers needed to repair damage that has permitted the guardrail to continue to function while the repair was scheduled

Two workers and a person in charge should be enough to make the repairs. This assumes only a few posts or rail beam sections are involved.

● Workers needed for major repair

When four, five, or more posts are involved or more than two rail beam sections have to be replaced, a crew of four is expected to be needed. If a wide range of power assisted tools is available to the crew, then a crew of three should be enough.

IF YOUR MAINTENANCE MANAGEMENT SYSTEM GIVES MORE DETAILED CREW SIZE BY WORK TASK FOR GUARDRAIL REPAIR, USE THAT CREW SIZE ESTIMATE.

VII. REPAIR SEQUENCE GUIDELINES

- Set up traffic control

Take enough signs and cones to the site to properly mark the repair zone. If an arrow board and/or a shadow truck are used by your organization, be certain to obtain enough equipment and personnel to handle these items. All workers should wear safety visibility vests.

- Disassemble the damaged guardrail

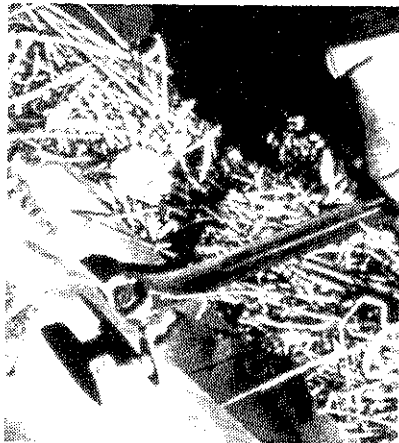

Spray the connecting bolts with penetrating oil (such as WD-40) for easier removal. Unbolt the damaged rail beam sections.



If the elliptical shoulder is worn off the bolt, hold the smooth round head with vise grips to unscrew the nut. Use a torch to cut stubborn bolts. Avoid cutting rail sections that can be straightened and reused later.

- Pullout the damaged posts



Steel posts can often be worked out by hand or with a crowbar. Wood posts may have to be dug out or pulled with a chain and hoist.

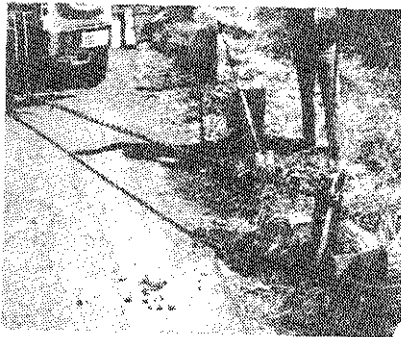

Slightly twisted steel posts that are still firmly in the ground can often be straightened in place by pulling with a chain attached to a truck. If the truck's operation encroaches on the traveled roadway, provide traffic control warning.

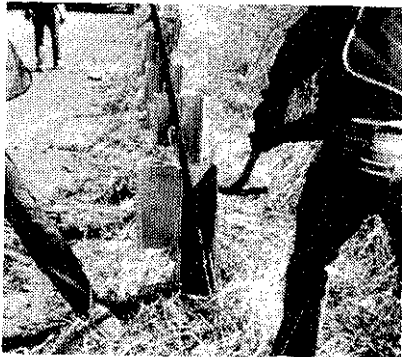

Likewise, posts that have only been pushed back off-line can be pulled back into line with a crowbar.

- If necessary, reshape the shoulder area with a grader and recompact the soil for posts.

- Set up a stringline to position posts at the proper height, alignment, and spacing.



Mark the stringline for the proper post height and alignment. Mark the proper post spacing with a tape or measuring stick.

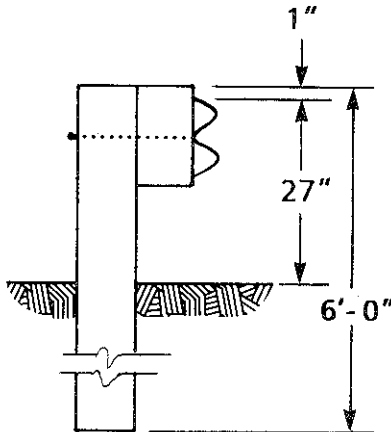

In the middle of an existing run of guardrail, check the height of the rail you are matching to be certain it is within 2 inches of the required standard height. If it is not, report to a maintenance supervisor.

- Drill or dig holes for the posts if necessary.
- Set or drive posts to the proper height.
- Backfill and tamp the soil around the posts.
- Check post alignment and height. Correct any major deviations.

- **Make a loose assembly of rail and blocks.**

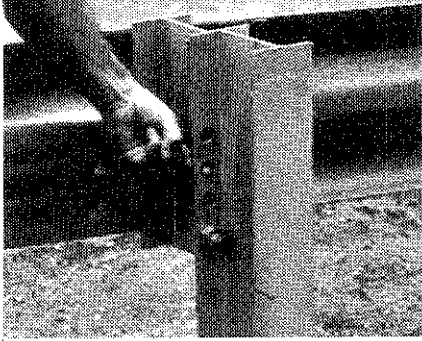

Attach new offset blocks to posts.



Starting downstream and working backwards, hang new rail sections. Overlap the rail the same as the existing rail. Where steel posts are used, a back-up plate is needed at the intermediate posts (the posts between the rail splices).

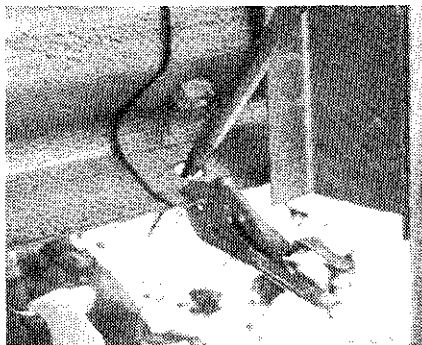

Use a drift pin to line up the holes for bolting.

- **Make sure all 8 bolts are in place in each splice connection.**
- **Leave all connections finger tight to allow for lengthwise adjustment after all sections are in.**

NOTES

- **Final assembly**—when all the rail is hung, go back and tighten all the bolts snugly. There is no need to overtighten.
- **Cleanup**—smooth out the shoulder and slope approaching the guardrail so the next vehicle to run into the guardrail has a smooth path.

Check after Repair is Completed

- _____ Have all the bolts been checked to see that each one is tightened snug?
- _____ Was a blockout used on each post?
- _____ Was a nail driven in each wood blockout to toenail the block to the wood post?
- _____ Does each steel post in between the splices have a back-up plate behind the rail beam?
- _____ If hazard markers or delineators or reflectors were installed, are they located properly on the guardrail?
- _____ Was the guardrail height checked to make sure it did not shift up or down out of tolerance during the final assembly?

Date repair completed: _____

Repair completion inspected by:

_____ (signed)

VIII. TRAFFIC CONTROL

Typical Traffic Control Layout for Lane Closure

NOTES:

1. Daytime operation and short repair duration.
2. Use this layout when repair work is on or within 2 feet of the travelled way (traffic lane).
3. Flaggers should use STOP/SLOW paddles instead of red flags.
4. Buffer zone may be reduced or extended depending on available sight distance.
5. Keep parked vehicles away from the traffic as much as possible.
6. Keep buffer zone free of obstacles or hazards.

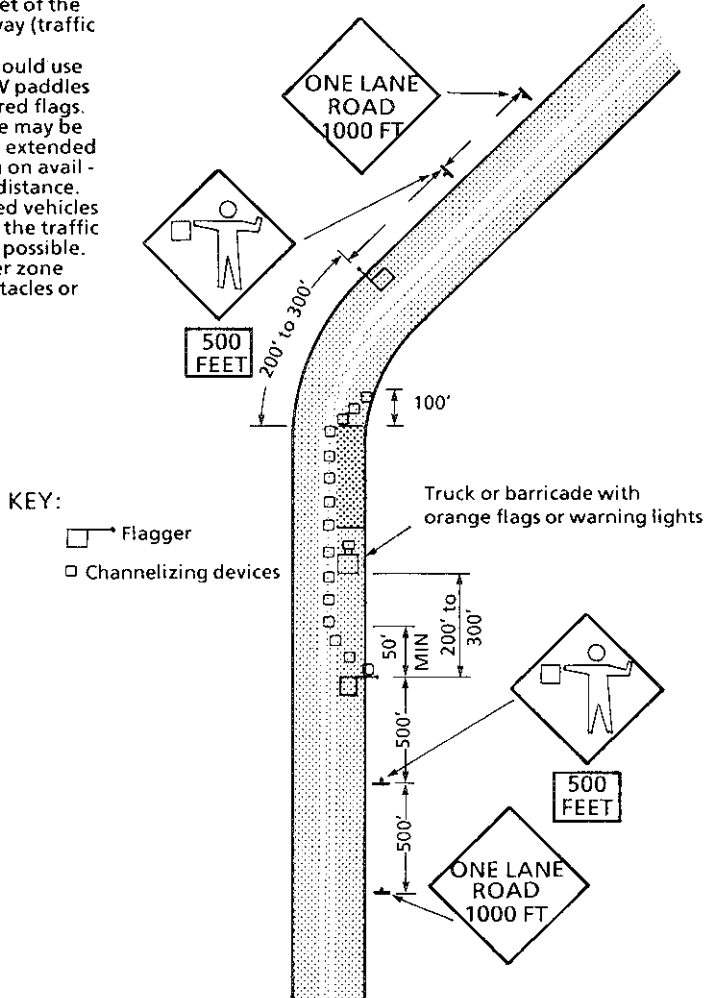

Equipment Check List–Lane Closure Work Zone Traffic Control Devices

1. Cones:		
Taper, see table below for spacing of cones (minimum of five)	_____	
Buffer zone (minimum of five spaced at 2 times speed in MPH)	_____	
Work area (minimum of five spaced at 2 times speed in MPH)	_____	
End section	_____	5
TOTAL		_____
2. STOP/SLOW paddles		2
3. Signs:		
ONE LANE ROAD AHEAD	_____	2
FLAGGER AHEAD, with distance plate	_____	2

NOTES:

1. You will need at least 20 cones. Depending on where the work is, the kind of road, and other conditions more devices might be needed. When in doubt, use more cones. **YOUR SAFETY IS AT STAKE.**
2. Any of several delineation devices may be used: cones, type 1 or type 2 barricades, drums, tubular markers, or vertical panels. Check with your supervisor for local policy.
3. Maximum spacing between devices is approximately equal in feet to the speed limit in MPH.

Suggested Taper Spacing

Road speed limit (MPH)	No. of cones	Lane Width		
		10'	11'	12'
20	5	18	19	20
25	6	21	23	25
30	7	25	27	30
35	8	29	32	35
40	9	34	37	40
45	13	38	42	45
50	13	42	46	50
55	13	46	51	55

Typical Traffic Control Layout for Shoulder Closure

NOTES:

1. Daytime operation and short repair duration.
2. Use this layout when repair work is on or within 2 feet of the travelled way (traffic lane).
3. Flaggers should use STOP/SLOW paddles instead of red flags.
4. Buffer zone may be reduced or extended depending on available sight distance.
5. Keep parked vehicles away from the traffic as much as possible.
6. Keep buffer zone free of obstacles or hazards.

KEY:

□ Channelizing devices

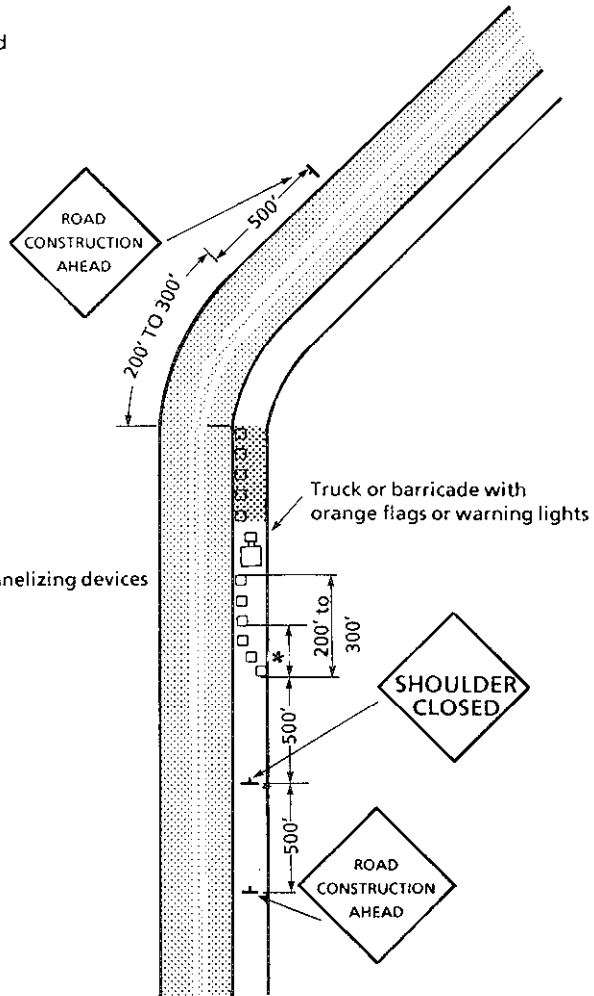

*See taper cone spacing table on p. 31.

Equipment Check List—Shoulder Closure Work Zone Traffic Control Devices

1. Cones:		
Taper, see table below for spacing of five cones	5	
Buffer zone (minimum of five spaced at 2 times speed in MPH)		_____
Work area (minimum of five spaced at 2 times speed in MPH)		_____
	TOTAL	_____
 2. Signs:		
ROAD CONSTRUCTION AHEAD		2
SHOULDER CLOSED		1

Spacing Guideline for
Suggested 5-cone Shoulder
Taper

Road speed limit (MPH)	Cone spacing (ft)
20	10
25	10
30	15
35	20
40	30
45	45
50	50
55	55

NOTES:

1. You will need at least 15 cones. Depending on where the work is, the kind of road, and other conditions more devices might be needed. When in doubt, use more cones. **YOUR SAFETY IS AT STAKE.**
2. Any of several delineation devices may be used: cones, type 1 or type 2 barricades, drums, tubular markers, or vertical panels. Check with your supervisor for local policy.
3. Maximum spacing between devices is approximately equal in feet to the speed limit in MPH.

IX. RECORDS OF REPAIRS

All agencies should have work records of the maintenance performed. If your agency has an existing system for keeping track of maintenance work, then use it to record the work you did in repairing the guardrail, recording the parts you used, when you did it, and that the work was checked for correctness.

If your agency does not have a complete record system, the following suggestions are offered.

- Use a copy of "Check after Repair is Completed" as a simple record that the repair was inspected when it was done.
- Keep a copy of the "Checklist of Materials for Repair" worksheet filled in with the parts you actually used. Salvaged or reused parts can be written in by hand. Sign and date the materials checklist when the repair is done.
- If an instant camera is available, take one or two Polaroid pictures of the completed repair. Date the photographs, and staple these items together to be filed in a completed Guardrail Repair file. Write on these sheets the location of the repair.

X. MAINTENANCE TIPS

- On a regular schedule, check the bolts for tightness on the splices, on the connections to the posts, and at the anchors to any bridge. Once a year or once every two years would be a help. Record any inspection by date and person doing it. This will help if there is ever a lawsuit from a crash.
- When a guardrail is hit and a large part of the guardrail at that location is damaged, check with a supervisor if the guardrail should be replaced or repaired. Sometimes a policy may exist that will allow removing the hazard from which the guardrail is protecting vehicles instead of repairing it. It might also be an older design which can be upgraded to a more current design if enough of the old design has been damaged.
- Try to keep the weeds and grass away from a guardrail. It helps the driver see the line of the rail to aim away from the hazard. It makes it easier to inspect the guardrail for needed repairs. It helps limit unevenness in the shoulder and approach to the guardrail when a vehicle is about to run into it.
- Watch for buildup of material under a rail or erosion of material out from under a rail that changes the height of the rail. It does not take long for this process in turf or aggregate shoulders to put a rail at the wrong height.

NOTES

