



U.S. Department of Transportation  
Federal Highway Administration

Publication No. FHWA-NHI-10-016  
FHWA GEC 010  
May 2010

NHI Course No. 132014

---

# Drilled Shafts: Construction Procedures and LRFD Design Methods

## Developed following:

AASHTO LRFD Bridge Design Specifications,  
4th Edition, 2007, with 2008 and 2009 Interims.



## **NOTICE**

The contents of this report reflect the views of the authors, who are responsible for the facts and accuracy of the data presented herein. The contents do not necessarily reflect policy of the Department of Transportation. This report does not constitute a standard, specification, or regulation. The United States Government does not endorse products or manufacturers. Trade or manufacturer's names appear herein only because they are considered essential to the object of this document.

**Technical Report Documentation Page**

1. Report No. FHWA NHI-10-016		2. Government Accession No.		3. Recipient's Catalog No.	
4. Title and Subtitle DRILLED SHAFTS: CONSTRUCTION PROCEDURES AND LRFD DESIGN METHODS NHI COURSE NO. 132014 GEOTECHNICAL ENGINEERING CIRCULAR NO. 10			5. Report Date May 2010		
			6. Performing Organization Code		
7. Author(s) Dan A. Brown*, Ph.D, P.E., John P. Turner**, Ph.D, P.E., and Raymond J. Castelli, P.E.			8. Performing Organization Report No.		
9. Performing Organization Name and Address PB Americas, Inc. One Penn Plaza, New York, NY 10119  * Dan Brown and Associates, PLLC., Sequatchie, TN 37374 ** University of Wyoming, Laramie, WY 82071			10. Work Unit No. (TRAIS)		
			11. Contract or Grant No. DTFH-61-D-00011/T-07-002		
12. Sponsoring Agency Name and Address National Highway Institute U.S. Department of Transportation Federal Highway Administration, Washington, D.C. 20590			13. Type of Report and Period Covered		
			14. Sponsoring Agency Code		
15. Supplementary Notes <i>FHWA COTR – Louisa Ward/ Larry Jones FHWA Task Manager – Silas Nichols, P.E. FHWA Technical Reviewers – J. Maswoswe, Ph.D, P.E.; J. DiMaggio, P.E. and F. I. S. Ibrahim, Ph.D., P.E. See Acknowledgement for Additional Co-Authors, Contributors and Technical Reviewers This document is a major update and revision of the 1999 FHWA Drilled Shafts manual authored by Michael W. O'Neill and Lymon C. Reese, Publication No. FHWA-IF-99-025.</i>					
16. Abstract This manual is intended to provide a technical resource for engineers responsible for the selection and design of drilled shaft foundations for transportation structures. It is used as the reference manual for use with the three-day National Highway Institute (NHI) training course No. 132014 on the subject, as well as the 10 <sup>th</sup> in the series of FHWA Geotechnical Engineering Circulars (GEC). This manual also represents a major revision and update of the FHWA publication on drilled shaft foundations co-authored by the late Michael O'Neal and late Lymon C. Reese, published in 1988 and revised in 1999. This manual embraces both construction and design of drilled shafts, and addresses the following topics: applications of drilled shafts for transportation structure foundations; general requirements for subsurface investigations; construction means and methods; LRFD principles and overall design process; geotechnical design of drilled shafts for axial and lateral loading; extreme events including scour and earthquake; LRFD structure design; field loading tests; construction specifications; inspection and records; non-destructive integrity tests; remediation of deficient shafts; and cost estimation. A comprehensive design example (Appendix A) is included to illustrate the step-by-step LRFD design process of drilled shafts as foundations for a highway bridge.					
17. Key Words Drilled Shafts, LRFD, Foundations, Site Characterization, Geomaterial Properties, Axial Capacity, Lateral Capacity, Seismic, Scour, Structural Design, Construction, Soil, Rock, Specifications, Inspection, Integrity Testing, Field Loading Test, Remediation.			18. Distribution Statement  No restrictions.		
19. Security Classif. (of this report) UNCLASSIFIED		20. Security Classif. (of this page) UNCLASSIFIED		21. No. of Pages 970	22. Price

## CONVERSION FACTORS

Approximate Conversions to SI Units			Approximate Conversions from SI Units		
When you know	Multiply by	To find	When you know	Multiply by	To find
(a) Length					
inch	25.4	millimeter	millimeter	0.039	inch
foot	0.305	meter	meter	3.28	foot
yard	0.914	meter	meter	1.09	yard
mile	1.61	kilometer	kilometer	0.621	mile
(b) Area					
square inches	645.2	square millimeters	square millimeters	0.0016	square inches
square feet	0.093	square meters	square meters	10.764	square feet
acres	0.405	hectares	hectares	2.47	acres
square miles	2.59	square kilometers	square kilometers	0.386	square miles
(c) Volume					
fluid ounces	29.57	milliliters	milliliters	0.034	fluid ounces
gallons	3.785	liters	liters	0.264	gallons
cubic feet	0.028	cubic meters	cubic meters	35.32	cubic feet
cubic yards	0.765	cubic meters	cubic meters	1.308	cubic yards
(d) Mass					
ounces	28.35	grams	grams	0.035	ounces
pounds	0.454	kilograms	kilograms	2.205	pounds
short tons (2000 lb)	0.907	megagrams (tonne)	megagrams (tonne)	1.102	short tons (2000 lb)
(e) Force					
pound	4.448	Newton	Newton	0.2248	pound
(f) Pressure, Stress, Modulus of Elasticity					
pounds per square foot	47.88	Pascals	Pascals	0.021	pounds per square foot
pounds per square inch	6.895	kiloPascals	kiloPascals	0.145	pounds per square inch
(g) Density					
pounds per cubic foot	16.019	kilograms per cubic meter	kilograms per cubic meter	0.0624	pounds per cubic foot
(h) Temperature					
Fahrenheit temperature(°F)	$5/9(^{\circ}\text{F} - 32)$	Celsius temperature(°C)	Celsius temperature(°C)	$9/5(^{\circ}\text{C}) + 32$	Fahrenheit temperature(°F)

Notes: 1) The primary metric (SI) units used in civil engineering are meter (m), kilogram (kg), second(s), newton (N) and pascal (Pa=N/m<sup>2</sup>).

2) In a "soft" conversion, an English measurement is mathematically converted to its exact metric equivalent.

3) In a "hard" conversion, a new rounded metric number is created that is convenient to work with and remember.

## ACKNOWLEDGMENTS

This reference manual is a major update and revision of the very successful Federal Highway Administration (FHWA) publication on drilled shaft foundations co-authored by the late Michael W. O’Neal and late Lymon C. Reese, published in 1988 and revised in 1999. Permission by the FHWA to include some original manuscripts and graphics from the previous versions is gratefully acknowledged.

This reference manual provides the technical contents for the NHI 132014 Course “Drilled Shafts” developed by Parsons Brinckerhoff (PB) team including Dan Brown, John Turner, Ray Castelli. And C. Jeremy Hung. The Drilled Shafts course is also a major update and revision of the 2003 National Highway Institute (NHI) 132014 Course “Drilled Shafts” developed by PB and authored by late Michael W. O’Neill, Dan Brown, & William Isenhower.

The authors would like to acknowledge the overwhelming support of Louisa Ward, NHI Program Manager, and Silas Nichols, FHWA Task Manger, and the reviews and contributions from Jerry DiMaggio of the Strategic Highway Research Program (SHRP2) at the National Academies. Especially Mr. DiMaggio’s guidance and input prior to his retirement from FHWA in 2008, and his continuing support afterward have been invaluable. In addition, the authors thank the reviews and recommendations provided by the following individuals that served on the Technical Working Group for this project:

- Silas Nichols, P.E. FHWA
- Justice Maswoswe, Ph.D, P.E. FHWA
- Firas I. S. Ibrahim, Ph.D, P.E. FHWA
- Curtis Monk, P.E. FHWA
- Naser Abu-Hejleh, Ph.D, P.E. FHWA
- Peter Osborn, P.E. FHWA
- Naresh C. Samtani, Ph.D, P.E. NCS Consultants, Inc.

Furthermore, the authors thank the following organizations and their technical committees and representatives for providing valuable information and review of the manual:

- International Association of Foundation Drilling (ADSC-IAFD).
- Deep Foundation Institute (DFI)
- The Deep Foundations Committee of the Geo-Institute of ASCE
- Transportation Research Board

In addition, the authors are grateful for the generous contributions and reviews of John Bryson and Kwang Ro of PB, Anton Schindler of Auburn University, James Long of University of Illinois. Mr. K. Gifford Goodhue, Jr., of KB International, reviewed an early draft of Chapter 7 and offered many useful suggestions regarding the materials on use of drilling fluids in drilled shaft construction. Mr. Alan Macnab, Condon-Johnson & Associates, contributed the first draft of Section 22.5 on Contractor Cost Computations. Professor Fred H. Kulhawy, Cornell University, offered many useful suggestions and references on revisions to the beta-method for side resistance of drilled shafts in cohesionless soils presented in Chapter 13 and Appendix C.

Lastly, the Authors would also like to extend our gratitude to the supports provided by a number of professionals from Parsons Brinckerhoff and Dan Brown and Associates, PLLC., including Lauren Chu Amy Pavlakovich, Matthew Smith, Alejandra Morales, and Maria Roberts of PB for their assistance and overall word processing and compiling.

Archived

This page is intentional left blank.

## TABLE OF CONTENTS

LIST OF FIGURES .....	xiii
LIST OF TABLES .....	xxiv
CHAPTER 1 - OVERVIEW - SELECTION AND USE OF DRILLED SHAFT FOUNDATIONS FOR TRANSPORTATION STRUCTURES .....	1-1
1.1 INTRODUCTION - PURPOSE AND ORGANIZATION OF MANUAL .....	1-1
1.2 TYPES OF DEEP FOUNDATIONS .....	1-3
1.3 DRILLED SHAFT FOUNDATIONS – DESCRIPTION AND HISTORY .....	1-3
1.4 SELECTION OF DRILLED SHAFTS .....	1-10
1.4.1 Applications .....	1-10
1.4.2 Advantages and Limitations.....	1-15
1.5 KEYS TO SUCCESSFUL USE OF DRILLED SHAFTS .....	1-15
1.6 SUMMARY .....	1-17
CHAPTER 2 - SITE CHARACTERIZATION .....	2-1
2.1 INTRODUCTION .....	2-1
2.2 ROLE OF THE GEOTECHNICAL ENGINEER.....	2-1
2.3 SITE CHARACTERIZATION PROGRAM .....	2-3
2.3.1 Data Collection .....	2-3
2.3.2 Field Reconnaissance.....	2-4
2.3.3 Detailed Field Investigations .....	2-5
2.3.4 Information Required for Construction.....	2-22
2.4 GEOTECHNICAL REPORTS .....	2-24
2.4.1 Geotechnical Investigation Report.....	2-24
2.4.2 Geotechnical Design Report .....	2-24
2.4.3 Data Presentation .....	2-26
2.4.4 Differing Site Conditions .....	2-27
2.4.5 Geotechnical Baseline Report.....	2-29
2.4.6 SUMMARY .....	2-29

CHAPTER 3 - GEOMATERIAL PROPERTIES .....	3-1
3.1 IN-SITU TESTING .....	3-1
3.1.1 Standard Penetration Test .....	3-1
3.1.2 Cone Penetration Test .....	3-5
3.2 SOIL PROPERTIES .....	3-7
3.2.1 Soil Index Properties and Classification .....	3-8
3.2.2 Shear Strength Properties .....	3-8
3.2.3 Deformation Properties .....	3-14
3.2.4 Soil Erodibility .....	3-16
3.2.5 In-Situ State of Stress .....	3-18
3.2.6 Unsaturated Soil Properties .....	3-19
3.3 PROPERTIES OF ROCK .....	3-21
3.3.1 Index Properties of Rock .....	3-21
3.3.2 Properties of Intact Rock .....	3-22
3.3.3 Strength of Rock Discontinuities .....	3-23
3.3.4 In-Situ Tests for Rock .....	3-23
3.3.5 Rock Mass Classification .....	3-26
3.3.6 Engineering Properties of Rock Mass .....	3-28
3.4 GEOMATERIALS REQUIRING SPECIAL CONSIDERATION .....	3-30
3.5 GEOMATERIAL PROPERTIES AND LRFD .....	3-31
 CHAPTER 4 - GENERAL CONSTRUCTION METHODS .....	 4-1
4.1 INTRODUCTION .....	4-1
4.2 DRY METHOD OF CONSTRUCTION .....	4-2
4.3 CASING METHOD OF CONSTRUCTION .....	4-6
4.4 WET METHOD OF CONSTRUCTION .....	4-12
4.5 BASE GROUTING .....	4-17
4.6 UNDERREAMS (BELLS) .....	4-20
4.7 BATTERED SHAFTS .....	4-22
4.8 SUMMARY .....	4-23
 CHAPTER 5 - TOOLS AND EQUIPMENT .....	 5-1
5.1 INTRODUCTION .....	5-1
5.2 DRILLING MACHINES .....	5-1
5.2.1 Overview of Rotary Systems .....	5-2



5.2.2	Mechanical vs Hydraulic Systems .....	5-3
5.2.3	Methods of Mounting Drilling Machine .....	5-3
5.2.4	Other Excavation Systems .....	5-9
5.2.5	Summary .....	5-13
5.3	TOOLS FOR EXCAVATION .....	5-13
5.3.1	Rotary Tools .....	5-13
5.3.2	Percussion and Other Tools.....	5-25
5.4	OTHER TECHNIQUES .....	5-29
5.4.1	Tools for Cleaning the Base of the Drilled Shaft Excavation .....	5-29
5.4.2	Grouting .....	5-30
5.4.3	Soil Mixing.....	5-30
5.4.4	Concrete Liner.....	5-31
5.5	SUMMARY .....	5-32
CHAPTER 6 - CASING AND LINERS.....		6-1
6.1	TEMPORARY CASING.....	6-1
6.1.1	Types and Dimensions .....	6-1
6.1.2	Installation and Extraction of Temporary Casing .....	6-4
6.1.3	Possible Effects of Temporary Casing on Axial and Lateral Resistance .....	6-10
6.1.4	Removing Casing after Concrete Sets.....	6-12
6.2	PERMANENT CASING.....	6-14
6.2.1	Types and Dimensions .....	6-16
6.2.2	Installation of Permanent Casing .....	6-17
6.2.3	Effects of Permanent Casing on Axial and Lateral Resistance .....	6-17
6.2	SUMMARY .....	6-18
CHAPTER 7 - DRILLING FLUIDS IN DRILLED SHAFT CONSTRUCTION.....		7-1
7.1	INTRODUCTION AND BACKGROUND .....	7-1
7.2	PRINCIPLES OF DRILLING FLUID PERFORMANCE FOR DRILLED SHAFTS .....	7-2
7.2.1	Mineral Slurries.....	7-2
7.2.2	Polymer Slurries.....	7-5
7.2.3	Blended Slurries .....	7-8
7.2.4	Example Applications and Limitations of Drilling Fluids in Drilled Shaft Construction.....	7-9
7.3	MATERIAL CHARACTERISTICS AND SLURRY MIX DESIGN .....	7-10

7.3.1	Bentonite .....	7-10
7.3.1	Polymers .....	7-10
7.4	CONTROL OF DRILLING FLUID DURING CONSTRUCTION .....	7-15
7.4.1	Mixing and Handling of Mineral Slurry .....	7-15
7.4.2	Mixing and Handling of Polymer Slurry.....	7-17
7.4.3	Sampling and Testing.....	7-19
7.4.4	Specifications for Drilling Slurry .....	7-27
7.5	ADDITIONAL DESIGN AND CONSTRUCTION CONSIDERATIONS.....	7-29
7.5.1	Borehole Inspection Under Drilling Fluids .....	7-29
7.5.2	Influence of Slurry on Axial Resistance of Drilled Shafts.....	7-29
7.5.3	Bond with Reinforcing Steel .....	7-35
7.5.4	Summary of Major Handling Considerations .....	7-36
7.6	SELECTION OF DRILLING FLUIDS .....	7-38
7.7	EXAMPLES OF PROBLEMS AND SOLUTIONS WITH CONSTRUCTION UNDER DRILLING FLUIDS.....	7-39
7.6	SUMMARY .....	7-43
CHAPTER 8 - REBAR CAGES.....		8-1
8.1	INTRODUCTION .....	8-1
8.2	PROPERTIES OF STEEL.....	8-1
8.3	LONGITUDINAL REINFORCING.....	8-3
8.4	TRANSVERSE REINFORCING .....	8-5
8.5	SPLICES .....	8-8
8.6	CONNECTION BETWEEN DRILLED SHAFT AND COLUMN .....	8-10
8.7	SIZING HOOPS .....	8-14
8.8	CENTERING DEVICES .....	8-15
8.9	STRENGTHENING THE CAGE TO RESIST LIFTING FORCES.....	8-16
8.10	ARRANGEMENTS FOR LIFTING CAGE.....	8-17
8.11	FABRICATION AND STORAGE.....	8-19
8.12	SUMMARY.....	8-21
CHAPTER 9 - PLACEMENT AND DESIGN OF CONCRETE FOR DRILLED SHAFTS .....		9-1
9.1	INTRODUCTION .....	9-1
9.2	BASIC CHARACTERISTICS OF DRILLED SHAFT CONCRETE.....	9-1
9.3	PLACEMENT OF CONCRETE .....	9-2

9.3.1	Placement in a Dry Shaft Excavation.....	9-3
9.3.2	Placement in a Dry Shaft Excavation within a Cased Hole .....	9-6
9.3.3	Placement of Concrete in a Wet Excavation .....	9-8
9.3.4	Records of Concrete Volume During Placement .....	9-17
9.3.5	Completion of Concrete Placement at Shaft Head.....	9-18
9.4	DRILLING NEAR A RECENTLY CONCRETED SHAFT.....	9-18
9.5	BASE GROUTING .....	9-19
9.6	CONCRETE MIX DESIGN .....	9-21
9.6.1	Cementitious Materials .....	9-21
9.6.2	Chemical Admixtures .....	9-24
9.6.3	Aggregate and Water .....	9-26
9.6.4	Workability .....	9-28
9.6.5	Control of Concrete Temperatures.....	9-30
9.6.6	Mixture Proportions .....	9-31
9.6.7	Communication of Project Specific Requirements for the Concrete .....	9-38
9.6.8	Strength.....	9-39
9.7	CONCRETE TESTS.....	9-39
9.7.1	Testing to Obtain Mixture Approval.....	9-39
9.7.2	Tests at the Batch Plant.....	9-40
9.7.3	Tests at the Jobsite .....	9-41
9.7.4	Addition of Water at Jobsite .....	9-42
9.7	SUMMARY.....	9-39
CHAPTER 10 - LRFD FOR DRILLED SHAFT DESIGN.....		10-1
10.1	INTRODUCTION TO LRFD .....	10-1
10.1.1	Development of Resistance Factors .....	10-3
10.2	AASHTO LIMIT STATES AND LOAD COMBINATIONS .....	10-7
10.3	AASHTO LIMIT STATES AND DRILLED SHAFT RESISTANCES.....	10-10
10.4	RESISTANCE FACTORS FOR DRILLED SHAFTS .....	10-11
10.4.1	Summary of Resistance Factors.....	10-11
10.4.2	Foundation Redundancy .....	10-16
10.4.3	Comparison with Driven Piles .....	10-16
10.5	CALIBRATION TO REGIONAL CONDITIONS OR AGENCY PRACTICE.....	10-16
10.5	SUMMARY .....	10-17

CHAPTER 11 - DESIGN PROCESS .....	11-1
11.1    OUTLINE OF THE OVERALL DESIGN AND CONSTRUCTION PROCESS .....	11-1
11.2    SUMMARY .....	11-11
CHAPTER 12 - LATERAL LOADING.....	12-1
12.1    INTRODUCTION .....	12-1
12.2    EXAMPLES OF LATERAL LOADING .....	12-1
12.2.1    Mon shaft Support for a Bridge Column.....	12-1
12.2.2    Shaft Group Foundations for Bridge Structures.....	12-3
12.2.3    Drilled-Shaft-Supported Bridge Over Water .....	12-4
12.2.4    Sound Walls, Sign Structures, High Mast Lighting .....	12-4
12.2.5    Foundation for a Bridge Abutment .....	12-5
12.2.6    Earth Retaining Structures .....	12-7
12.2.7    Stabilization of a Moving Slope.....	12-8
12.3    DESIGN FOR LATERAL LOADING.....	12-9
12.3.1    Design Process .....	12-9
12.3.2    Planning Stage Estimates .....	12-12
12.3.3    Computational Procedures and Design Methodology.....	12-15
12.3.4    Alternative Models for Computation of Shaft Response .....	12-42
12.3.5    Design of Drilled Shaft Walls .....	12-47
12.3.6    Design for Drilled Shaft Foundations with Lateral Movement of Soil Mass .....	12-58
12.4    SUMMARY.....	12-62
CHAPTER 13 - AXIAL LOADING .....	13-1
13.1    AXIAL LOAD TRANSFER – BASIC CONCEPTS.....	13-1
13.2    RELATIONSHIP TO OVERALL DESIGN PROCESS .....	13-2
13.3    STEP-BY-STEP PROCEDURE: DESIGN FOR AXIAL LOAD .....	13-3
13.3.1    Idealized Geomaterial Layer Profiles.....	13-5
13.3.2    Review Limit States and Factored Axial Loads.....	13-7
13.3.3    Geomaterial Properties and Loading Response Mode .....	13-7
13.3.4    Trial Designs .....	13-8
13.3.5    Calculate Nominal Side and Base Resistances .....	13-10
13.3.6    Evaluate Trial Design for Strength Limit States .....	13-28
13.3.7    Evaluate Trial Design for Service Limit States.....	13-28
13.3.8    Final Trial Design for Axial Compression.....	13-39

13.4	DESIGN FOR UPLIFT .....	13-39
13.5	DESIGN FOR SCOUR .....	13-42
13.5.1	Background and Definitions .....	13-42
13.5.2	Design Philosophy for Scour .....	13-43
13.5.3	Analysis and Prediction of Scour .....	13-44
13.5.4	Application to Drilled Shaft Design .....	13-46
13.5.4	Effects of Scour on Axial Resistance .....	13-47
13.6	DOWNDRAG .....	13-48
13.6.1	Occurrence .....	13-48
13.6.2	Downdrag – Basic Concepts .....	13-50
13.6.3	Analysis of Downdrag .....	13-51
13.6.4	Downdrag Forces .....	13-54
13.6.5	Limit States Evaluation Under Downdrag .....	13-55
13.6.6	Strategies to Address Downdrag .....	13-57
13.7	DESIGN FOR EFFECTS OF EXPANSIVE SOIL .....	13-58
13.7.1	Occurrence and Identification of Expansive Soils .....	13-58
13.7.2	Estimating the Zone of Seasonal Moisture Change .....	13-59
13.7.3	Design Solutions .....	13-60
13.8	SUMMARY .....	13-65
CHAPTER 14 - DESIGN OF GROUPS OF DRILLED SHAFTS .....		14-1
14.1	INTRODUCTION .....	14-1
14.2	GROUP VERSUS SINGLE SHAFT FOUNDATION .....	14-2
14.3	CONSIDERATIONS FOR SPACING .....	14-2
14.4	Group Effects on Axial Resistance .....	14-3
14.4.1	Group Effects on Strength .....	14-4
14.4.2	Settlement of Shaft Groups .....	14-9
14.4.3	Group Effects in Rock and Cohesive IGM .....	14-16
14.5	GROUP EFFECTS IN LATERAL LOADING .....	14-16
14.5.1	P-multiplier Concept .....	14-16
14.5.2	Use of P-multiplier in Computer Codes .....	14-18
14.5.3	Strain Wedge Approach .....	14-20
14.6	COMBINED LOADING AND COMPUTATION OF LOAD DISTRIBUTION TO GROUP .....	14-20
14.6.1	Simple Static Equilibrium .....	14-21

14.6.2	Simple Elastic Solution.....	14-23
14.6.3	Nonlinear Computer Solution.....	14-27
14.7	SUMMARY.....	14-28
CHAPTER 15 - DESIGN FOR EXTREME EVENTS.....		15-1
15.1	DESIGN FOR EXTREME EVENT SCOUR.....	15-1
15.2	DESIGN FOR EARTHQUAKE.....	15-2
15.2.1	Framework for Analysis of Earthquake Effects.....	15-2
15.2.2	Time-History Analysis.....	15-8
15.2.3	Effects of Liquefaction.....	15-9
15.2.4	Discussion of the AASHTO Guide Specifications for LRFD Seismic Bridge Design.....	15-12
15.3	DESIGN FOR EFFECTS OF ICE AND COLLISIONS.....	15-13
15.3.1	LRFD Framework for Extreme Event II.....	15-13
15.3.2	Determination of Force Effects on Drilled Shafts.....	15-14
15.4	DESIGN FOR COMBINED EXTREME EVENTS.....	15-17
15.5	SUMMARY.....	15-18
CHAPTER 16 - STRUCTURAL DESIGN.....		16-1
16.1	INTRODUCTION.....	16-1
16.2	MATERIAL PROPERTIES.....	16-3
16.2.1	Concrete.....	16-3
16.2.2	Reinforcing Steel.....	16-4
16.2.3	Casings.....	16-4
16.3	MINIMUM AND MAXIMUM AMOUNT OF LONGITUDINAL STEEL REINFORCEMENT.....	16-4
16.4	MINIMUM AMOUNT OF TRANSVERSE STEEL REINFORCEMENT.....	16-5
16.5	CONCRETE COVER AND CAGE CENTERING DEVICES.....	16-7
16.6	CASES WITH AXIAL LOAD ONLY.....	16-7
16.6.1	Axial Compression.....	16-7
16.6.2	Tension Members.....	16-8
16.6	CASES WITH AXIAL LOAD AND BENDING MOMENT.....	16-9
16.7.1	General Concepts.....	16-9
16.7.2	Structural Design Procedure: Longitudinal and Transverse Reinforcement.....	16-12
16.7.3	Depth of Transverse Reinforcement.....	16-17

16.7.4	Splices, Connections, and Cutoffs .....	16-18
16.8	OTHER CONSIDERATIONS.....	16-19
16.8.1	Drilled Shafts with Rock Sockets .....	16-19
16.8.2	Drilled Shafts with Permanent Casing .....	16-21
16.8.3	Structural Analysis of Plain-Concrete Underreams .....	16-24
CHAPTER 17	FIELD LOADING TEST .....	17-1
17.1	GENERAL .....	17-1
17.1.1	Benefits and Limitations of Field Load Testing .....	17-2
17.1.2	Design-Phase Load Testing Program.....	17-3
17.1.3	Field Load Testing Program at the Start of Construction .....	17-4
17.1.4	Proof Tests on Production Shafts.....	17-4
17.1.5	Field Load Testing for Research.....	17-6
17.2	LOAD TESTS TO MEASURE AXIAL RESISTANCE .....	17-7
17.2.1	General Considerations in Planning Axial Load Tests .....	17-7
17.2.2	Test Methods.....	17-16
17.2.3	Instrumentation .....	17-50
17.2.4	Interpretation of Axial Test Results for Design .....	17-61
17.3	LOAD TESTS TO MEASURE LATERAL RESISTANCE.....	17-62
17.3.1	General Considerations in Planning Lateral Load Tests.....	17-62
17.3.2	Test Methods and Procedures .....	17-64
17.3.3	Instrumentation .....	17-68
17.3.4	Interpretation of Lateral Test Data.....	17-72
17.4	SUMMARY .....	17-73
CHAPTER 18	GUIDE DRILLED SHAFT CONSTRUCTION SPECIFICATION.....	18-1
18.1	DESIGN CONSIDERATIONS .....	18-1
18.2	QUALIFICATIONS OF DRILLED SHAFT CONTRACTORS.....	18-2
18.3	CONSTRUCTION METHOD .....	18-2
18.4	DRILLING FLUID .....	18-3
18.5	LOAD TESTING .....	18-3
18.6	INTEGRITY TESTING .....	18-4
18.7	CONSTRUCTION PHASE SUBSURFACE INVESTIGATIONS .....	18-5
18.8	DRILLED SHAFT INSTALLATION PLAN .....	18-5
18.9	MEASUREMENT AND PAYMENT .....	18-6

18.10	SUMMARY .....	18-7
CHAPTER 19	- INSPECTIONS AND RECORDS .....	19-1
19.1	RESPONSIBILITIES .....	19-1
19.2	INSPECTION ACTIVITIES .....	19-3
19.2.1	Set-Up .....	19-6
19.2.2	Casing .....	19-6
19.2.3	Drilling Fluid .....	19-7
19.2.4	Drilled Shaft Excavation .....	19-7
19.2.5	Placement of Reinforcement .....	19-9
19.2.6	Concrete Placement .....	19-10
19.2.7	Completed Drilled Shaft .....	19-12
19.3	COMMON PROBLEMS .....	19-12
19.4	DIFFERING SITE CONDITION .....	19-14
19.5	RECORDS AND FORMS .....	19-14
19.6	SUMMARY .....	19-15
CHAPTER 20	- TESTS FOR COMPLETED DRILLED SHAFTS .....	20-1
20.1	INTRODUCTION .....	20-1
20.2	NON-DESTRUCTIVE INTEGRITY TESTS .....	20-1
20.2.1	Sonic Methods .....	20-2
20.2.2	Gamma-Gamma Method .....	20-9
20.2.3	Methods Based on Analysis of Stress Waves .....	20-13
20.2.4	Thermal Methods .....	20-19
20.3	DRILLING AND CORING .....	20-20
20.3.1	Downhole Video Inspection .....	20-22
20.4	LOAD TESTING FOR DRILLED SHAFT INTEGRITY EVALUATION .....	20-22
20.5	DESIGN OF AN INTEGRITY TESTING PROGRAM AND ACCEPTANCE CRITERIA .....	20-23
20.5.1	When to Use NDT .....	20-23
20.5.2	Evaluation of Defects and Acceptance Criteria .....	20-24
20.4	SUMMARY .....	20-22
CHAPTER 21	- Remediation of Deficient Drilled Shafts .....	21-1
21.1	INTRODUCTION .....	21-1
21.2	PROBLEMS PRIOR TO COMPLETION OF CONCRETE PLACEMENT .....	21-4



21.3	Types of Deficiencies in Completed Shafts .....	21-4
21.3.1	Geotechnical Strength or Servicability .....	21-5
21.3.2	Structural Strength .....	21-6
21.4	EVALUATION.....	21-7
21.5	REMEDICATION METHODS.....	21-8
21.5.1	Ground Improvement.....	21-9
21.5.2	Supplemental Foundations and/or Structural Bridging.....	21-9
21.5.3	Excavation and Replacement .....	21-13
21.5.4	Structural Enhancement .....	21-13
21.5.5	Grouting .....	21-14
21.6	SUMMARY .....	21-18
CHAPTER 22 - COST ESTIMATION .....		22-1
22.1	GENERAL .....	22-1
22.2	FACTORS INFLUENCING COST .....	22-1
22.3	COMMENTARY .....	22-4
22.4	HISTORICAL PRICE DATA AVAILABLE THROUGH THE INTERNET .....	22-4
22.5	CONTRACTORS' COST COMPUTATION.....	22-7
22.5.1	Variable Costs.....	22-8
22.5.2	Jobsite Fixed Costs .....	22-9
22.5.3	Overhead.....	22-9
22.5.4	Contingencies.....	22-9
22.5.5	Markup.....	22-10
22.5.6	Unit Prices.....	22-10
22.5.7	Other Considerations .....	22-10
22.6	EXAMPLES .....	22-11
22.6.1	Texas.....	22-11
22.6.2	Washington.....	22-11
CHAPTER 23 - REFERENCES .....		23-1

LIST OF APPENDICES

APPENDIX A - DESIGN EXAMPLE FOR REPLACEMENT BRIDGE..... A-1

APPENDIX B - GEOMATERIAL PROPERTIES FOR DRILLED SHAFTS IN SPECIFIC GEOLOGIC ENVIRONMENTS ..... B-1

APPENDIX C - COMMENTARY ON METHODS FOR COMPUTING NOMINAL AXIAL RESISTANCE OF DRILLED SHAFTS ..... C-1

APPENDIX D - ANALYSIS OF AXIAL LOAD DEFORMATION RESPONSE ..... D-1

APPENDIX E - DRILLED SHAFT LOAD TEST DATA..... E-1

APPENDIX F - SAMPLE DRILLED SHAFT INSPECTION FORMS, CHECKLISTS AND TABLES .....F-1

APPENDIX G - STANDARD CIDH PILE ANOMALY MITIGATION PLAN..... G-1

APPENDIX H - ALTERNATIVE MODELS FOR ANALYSIS OF LATERAL LOADING..... H-1

Archived

## LIST OF FIGURES

Figure 1-1	Holistic Design Example	1-2
Figure 1-2	Schematic of Axial and Lateral Resistance of a Drilled Shaft	1-4
Figure 1-3	Pneumatic Caisson for Firth of Forth Bridge	1-5
Figure 1-4	Caisson Construction for Greenville Bridge	1-6
Figure 1-5	“Caisson” Foundation Construction in Kansas City	1-6
Figure 1-6	Early “Caisson” Foundations	1-7
Figure 1-7	An Early Drilled Shaft Rig and Crew	1-8
Figure 1-8	Typical Modern Drilled Shaft Rigs	1-9
Figure 1-9	Construction of 12ft Dia. Drilled Shafts for the Main Pylon Foundation, Christopher S. Bond Bridge, Kansas City	1-9
Figure 1-10	Construction of Drilled Shaft in Dry, Cohesive Soils	1-11
Figure 1-11	Drilled Shafts for Bridge Foundations where Small Footprint is Desirable	1-11
Figure 1-12	Drilled Shafts for Individual Column Support over Water	1-12
Figure 1-13	Group of Drilled Shafts for Large Loads	1-12
Figure 1-14	Drilled Shafts Installed for Deep Scour Problem	1-13
Figure 1-15	Drilled Shafts with Low Headroom	1-13
Figure 1-16	Drilled Shafts for Soundwall and Sign	1-14
Figure 1-17	Drilled Shafts Used to Support Earth Retaining Structures	1-14
Figure 1-18	Drilled Shaft Secant Wall and Tangent Wall	1-15
Figure 2-1	Seismic Refraction Method	2-7
Figure 2-2	ReMi Seismic Velocity Profile	2-8
Figure 2-3	Field Configuration for Resistivity Test	2-8
Figure 2-4	Resistivity Tomogram, Pennsylvania Bridge Site in Karst	2-9
Figure 2-5	Common Sampling Devices for Soil	2-14
Figure 2-6	Field Photography of Rock Core	2-17
Figure 2-7	RQD Determination from Rock Core	2-17
Figure 2-8	Example of Key to Rock Core Log	2-20
Figure 2-9	Example of Key to Rock Core Log, continued from Figure 2-8	2-21
Figure 2-10	Example of Site Investigation Plan Location Map	2-27
Figure 2-11	Example Subsurface Profile for a Bridge Site	2-28
Figure 3-1	Schematic of Common In-Situ Tests	3-2
Figure 3-2	Split-Spoon Sampler for Determination of Soil Stratigraphy	3-4
Figure 3-3	Cone Penetration Test Equipment	3-6
Figure 3-4	Soil Behavior Type Classification Chart Based on Normalized CPT and CPTu Data	3-7
Figure 3-5	Typical Ranges of Friction Angle for Rockfills, Gravels, and Sands	3-11
Figure 3-6	Relationship Between $\phi'$ and PI of Clay Soils	3-12
Figure 3-7	Example of Soil Stress-Strain Curve and 50% Secant Modulus	3-15
Figure 3-8	Erosion Function Apparatus and Measured Erosion Function	3-18
Figure 3-9	Typical Pressure-Dilation Graphs for a Pressuremeter Test in Rock	3-25
Figure 3-10	Chart for Determination of GSI for Jointed Rock Mass	3-27
Figure 4-1	Dry Hole in Stable Soil	4-3
Figure 4-2	Cuttings from a Dry Hole Spun off the Auger	4-4
Figure 4-3	Placement of Reinforcing Cage into the Excavation	4-5
Figure 4-4	Placement of Concrete into a Dry Excavation	4-5
Figure 4-5	Dry Method of Construction	4-6
Figure 4-6	Drilling into Rock through a Cased Hole	4-7
Figure 4-7	Construction Using Casing Through Slurry-Filled Starter Hole	4-8
Figure 4-8	Construction Using Casing Advanced Ahead of Excavation	4-8

Figure 4-9	Oscillator Rig Used to Advance Segmental Casing Ahead of the Excavation	4-9
Figure 4-10	Use of a Vibro-Hammer and Twister Bar to Advance Casing	4-9
Figure 4-11	Cutting Teeth on the Casing to Assist Penetration into the Bearing Stratum	4-10
Figure 4-12	Breach of Casing/Concrete Seal During Casing Extraction Due to Cavity	4-10
Figure 4-13	Telescoping Casing	4-12
Figure 4-14	Slurry Provides Seepage Pressure Against Excavation Surface	4-13
Figure 4-15	Slurry Drilling Process	4-14
Figure 4-16	Use of Surface Casing to Overcome Artesian Groundwater	4-15
Figure 4-17	Bottom Clean-out Bucket with Portal for Slurry Passage	4-15
Figure 4-18	Wet Hole Construction Using Full Length Casing	4-16
Figure 4-19	Reverse Circulation Drilling	4-17
Figure 4-20	Schematic of Base Grout Process	4-18
Figure 4-21	Base Grouting Systems Tied to Reinforcing Cage	4-19
Figure 4-22	Pumping Grout to the Base of the Shaft	4-19
Figure 4-23	Exhumed Shafts after Grouting	4-19
Figure 4-24	Shapes of Typical Underreams	4-21
Figure 5-1	An Early Drilled Shaft Machine and Crew	5-2
Figure 5-2	Drill Rig Terminology	5-2
Figure 5-3	Mechanical and Hydraulic Powered Drilling Machines	5-4
Figure 5-4	Truck Mounted Drilling Rigs	5-5
Figure 5-5	Crane Mounted Drilling Rig	5-6
Figure 5-6	Crawler Mounted Drilling Rigs	5-7
Figure 5-7	Excavator Mounted Drilling Machines for Restricted Overhead Conditions	5-7
Figure 5-8	Oscillator Machine	5-8
Figure 5-9	Rotator Machine	5-8
Figure 5-10	Top-Drive Reverse Circulation Drill	5-10
Figure 5-11	Reverse Circulation Cutting Heads for Top-Drive Drill	5-10
Figure 5-12	Manual Excavation in Rock	5-11
Figure 5-13	Excavation of a Diaphragm Wall or Barrette Using a Clam	5-12
Figure 5-14	Excavation of a Diaphragm Wall or Barrette Using a Hydromill	5-12
Figure 5-15	Single Flight Earth Augers	5-14
Figure 5-16	Double Flight Earth Augers	5-15
Figure 5-17	Large Diameter Auger with Double Cutting Edge	5-15
Figure 5-18	Auger with Slurry Bypass	5-16
Figure 5-19	Boulder Rooters	5-17
Figure 5-20	Rock Augers	5-18
Figure 5-21	Typical Drilling Buckets	5-19
Figure 5-22	Clean-out Buckets	5-20
Figure 5-23	Single Wall Core Barrels	5-21
Figure 5-24	Double Wall Core Barrels	5-22
Figure 5-25	Rock Cores	5-22
Figure 5-26	Full-Faced Rotary Cutters	5-23
Figure 5-27	Belling Buckets	5-24
Figure 5-28	Special Rotary Tools: Grooving Tool and “Backscratcher”	5-25
Figure 5-29	Boulder-Grabber Tool	5-25
Figure 5-30	Clam-shell Buckets	5-26
Figure 5-31	Hammergrabs	5-27
Figure 5-32	Drop Chisels and Rock Breakers	5-28
Figure 5-33	Downhole Impact Hammers	5-29
Figure 5-34	Airlift and Hydraulic Pumps for Shaft Base Cleanout	5-30
Figure 5-35	Use of Soil Mixed Columns in Conjunction with Drilled Shafts for a Wall	5-31

Figure 5-36	Construction of Concrete-Lined Shaft	5-32
Figure 6-1	A Typical View of Stored Temporary Casing	6-2
Figure 6-2	Exceptionally Large Temporary Casings	6-3
Figure 6-3	Segmental Casing Installation with Oscillator System	6-4
Figure 6-4	Installation of Casing Joint on Standard Pipe	6-4
Figure 6-5	J Slots in Top of Casing for Use with Casing Twister	6-5
Figure 6-6	Teeth for Use in Sealing Casing into Rock	6-6
Figure 6-7	Use of Telescoping Casing	6-6
Figure 6-8	Extraction of Temporary Casing Using a Vibratory Hammer	6-8
Figure 6-9	Cutting Shoe for Segmental Casing	6-9
Figure 6-10	Adverse Effect of Casing Extended into Rock Socket	6-10
Figure 6-11	Exposed Surface of Drilled Shafts Constructed Using Oscillated and Rotated Casing	6-11
Figure 6-12	Locking Mechanism for a Removable Casing	6-13
Figure 6-13	Construction Joint Below the Water Surface	6-14
Figure 6-14	Example of Use of Permanent Casing	6-15
Figure 6-15	Permanent Casing Used for a Shaft Group Foundation in a River	6-16
Figure 6-16	Corrugated Metal Pipe (CMP) Used as Permanent Liner	6-17
Figure 7-1	Formation of Filter Cake and Positive Effective Pressure, Mineral Slurry in Sand Formation	7-3
Figure 7-2	Mineral Slurry Plates in Pores of Open-pored Formation	7-4
Figure 7-3	PAM Polymer Slurry	7-6
Figure 7-4	Stabilization of Borehole by the Use of Polymer Drilling Slurries	7-7
Figure 7-5	Schematic Diagram of Unit for Mixing and Treating Mineral Slurry	7-16
Figure 7-6	Field Mixing Polymer Slurry by Circulating Between Tanks	7-18
Figure 7-7	Techniques for Handling Polymer Slurry	7-18
Figure 7-8	Device for Downhole Sampling of Slurry	7-20
Figure 7-9	Mud Density Balance for Field Measurement of Slurry Density	7-21
Figure 7-10	Marsh Funnel Test for Field Evaluation of Slurry Viscosity	7-22
Figure 7-11	Schematic of Slurry Viscometer	7-22
Figure 7-12	Interpretation of Data from a Viscometer Test	7-23
Figure 7-13	Photograph of Sand Content Test Apparatus	7-25
Figure 7-14	Average Load Transfer in Side Shear for Different Construction Methods	7-34
Figure 7-15	Mobilized Unit Side Resistance in Lower Fort Thompson Formation Rock Sockets	7-35
Figure 7-16	Placing Concrete through Heavily-Contaminated Slurry	7-40
Figure 7-17	Placing Casing into Mineral Slurry with Excessive Solids Content	7-40
Figure 7-18	Pulling Casing with Insufficient Head of Concrete	7-41
Figure 7-19	Placing Concrete where Casing was Improperly Sealed	7-42
Figure 8-1	GR75 Reinforcement Cage Being Assembled, Showing Threaded Couplers	8-3
Figure 8-2	View of a Rebar Cage Being Assembled, Showing Longitudinal Steel	8-4
Figure 8-3	View of Bundles of No.18 Rebar in a Drilled Shaft Cage	8-5
Figure 8-4	Transverse Ties and Spiral Steel, Showing Hook Anchors and Spiral Laps	8-6
Figure 8-5	Possible Distortion of Poorly Assembled Cage Due to Pickup Forces or Hydraulic Forces from Fresh Concrete	8-7
Figure 8-6	Examples of Inadequate Flow of Concrete Through Tightly Spaced Spiral Reinforcement	8-7
Figure 8-7	Bundled Hoops Used to Improve Flow of Concrete Through Transverse Reinforcement	8-8
Figure 8-8	Constructability Problem From Excessive Concentration of Lap Splices	8-9
Figure 8-9	Bar Couplers Used to Construct Splices	8-9
Figure 8-10	Adjustment to Drilled Shaft Reinforcement for Alignment to Column Cage	8-10
Figure 8-11	Type I and II Connections	8-11

Figure 8-12	Washington DOT Type II Connection Detail	8-12
Figure 8-13	Construction of a Type II Connection Detail over Water	8-13
Figure 8-14	Splice Cage Used to Fabricate Column to Shaft Connection	8-14
Figure 8-15	Sizing Hoop Assembly	8-14
Figure 8-16	Roller Centralizers on Reinforcing Cage	8-15
Figure 8-17	Chairs for Base of Reinforcing Cage	8-16
Figure 8-18	Transverse and Longitudinal Stiffeners for Temporary Strengthening of the Rebar Cage	8-17
Figure 8-19	Transverse Stiffeners Attached with Tack-Welds to Sizing Hoops	8-17
Figure 8-20	Photograph of Rebar Cage Being Lifted Improperly	8-18
Figure 8-21	Photograph of Rebar Cage Being Lifted Properly	8-18
Figure 8-22	Photograph of Rebar Cage Being Lifted with a Tipping Frame	8-19
Figure 8-23	Photograph of Rebar Cage Being Delivered to Site	8-20
Figure 8-24	Photograph of Rebar Cage Being Assembled Over the Shaft Excavation	8-20
Figure 9-1	Free Fall Concrete Placement in a Dry Excavation	9-3
Figure 9-2	Placement into a Dry Excavation Using a Drop Chute	9-4
Figure 9-3	Excessive Seepage Precludes Free Fall Placement of Concrete	9-5
Figure 9-4	Concrete Pressure Head Requirement During Casing Extraction	9-6
Figure 9-5	Slurry Displaced from Annular Space during Casing Extraction	9-7
Figure 9-6	Concrete Placement with Telescoping Casing	9-8
Figure 9-7	Tremie Must be Clean	9-9
Figure 9-8	Solid Tremie Pipes	9-10
Figure 9-9	Assembly of Segmental Tremie for Concrete Placement	9-10
Figure 9-10	Closure Plates for Closed Tremie	9-11
Figure 9-11	Control of Tremie to Establish Concrete Head	9-12
Figure 9-12	Breach of Tremie Due to Failure to Establish Concrete Head	9-12
Figure 9-13	Schematic of Concrete “Vent” Due to Loss in Concrete Mix Workability During Tremie Placement	9-13
Figure 9-14	Effects of Loss in Concrete Mix Workability During Tremie Placement	9-14
Figure 9-15	Pump Line Operations for Underwater Concrete Placement	9-15
Figure 9-16	Exposed Bottom Surface of an Exhumed Drilled Shaft	9-16
Figure 9-17	Example Concrete Volume Plots	9-17
Figure 9-18	Over-pour of the Shaft Top Until Clean Concrete is Revealed	9-18
Figure 9-19	Sleeve Port System for Distribution of Grout to the Base of the Shaft	9-20
Figure 9-20	Good Passing Ability is Required to Flow through Reinforcement	9-21
Figure 9-21	Simulated Effects of using SCMs on the Maximum Concrete Temperature Reached	9-23
Figure 9-22	The Effect of Different Initial Mixture Temperatures on the Temperature Development During Adiabatic Conditions	9-30
Figure 9-23	Slump Loss Relationship from a Trial Mixture Design	9-33
Figure 9-24	Concrete with Insufficient Workability for Use in Drilled Shafts	9-36
Figure 9-25	Concrete with High Workability but with Improper Mixture Design for Tremie Placement	9-37
Figure 9-26	Drilled Shaft Concrete with High Workability - 9.0 inch Slump	9-37
Figure 9-27	Drilled Shaft Concrete with Moderate Workability - 6.5 inch Slump	9-37
Figure 9-28	Self-consolidating Concrete with a 20 in. Slump Flow Used in Drilled Shaft Construction	9-38
Figure 9-29	Worksite Concrete Batch Plant Capable of Batching 130 yd <sup>3</sup> /hr	9-40
Figure 10-1	Reliability Concepts	10-5
Figure 10-2	Structural Analysis of Bridge Used to Establish Foundation Force Effects	10-9
Figure 11-1	Drilled Shaft Design and Construction Process	11-2
Figure 12-1	Single Column Piers with Mon shaft Foundations	12-2

Figure 12-2	Monoshaft Foundations Used by Caltrans	12-2
Figure 12-3	Example of a Drilled Shaft Group Foundation for a Bridge	12-3
Figure 12-4	Drilled Shafts for Bridge Over Water, Somerset, KY	12-4
Figure 12-5	Elevation View of an Overhead Sign Structure	12-5
Figure 12-6	Sketch of Foundation for a Bridge Abutment	12-6
Figure 12-7	Drilled Shaft Abutment Foundations	12-6
Figure 12-8	Arch Bridge	12-7
Figure 12-9	Drilled Shaft Secant Wall and Tangent Wall	12-7
Figure 12-10	Drilled Shaft Foundation for Retaining Wall using Soldier Piles and Precast Panels	12-8
Figure 12-11	Drilled Shafts for Stabilizing a Slide	12-8
Figure 12-12	Analysis of Drilled Shafts in Moving Soil	12-9
Figure 12-13	Drilled Shaft Design Process for Lateral Loads	12-10
Figure 12-14	Equivalent Length Concept for Preliminary Design	12-13
Figure 12-15	Equivalent Length of Shaft for Preliminary Design of Single Shaft Foundation	12-13
Figure 12-16	Model of a Drilled Shaft Foundation Under Lateral Loading Showing Concept of Soil	12-17
Figure 12-17	Definition of Terms in Equations 12-6 and 12-7	12-21
Figure 12-18	Variation of EI of a Drilled Shaft Cross Section with Bending Moment and Axial	12-22
Figure 12-19	Stress-Strain Model for Concrete	12-23
Figure 12-20	Stress-Strain Model for Steel Reinforcement	12-23
Figure 12-21	Simple Lateral Load Example, Factored Loads Shown	12-27
Figure 12-22	Results of Analyses of Geotechnical Strength for Simple Example	12-28
Figure 12-23	Results of Analyses of Structural Strength and Serviceability for Simple Example	12-29
Figure 12-24	Bending Moment vs. Curvature for Simple Example	12-30
Figure 12-25	EI vs. Bending Moment for Simple Example	12-30
Figure 12-26	Conceptual p-y Curve for Cohesive Soil	12-31
Figure 12-27	Conceptual p-y Curve for Stiff Clay in the Presence of Free Water	12-32
Figure 12-28	Conceptual p-y Curve for Cohesionless Soil	12-33
Figure 12-29	Proposed p-y Criterion for Weak Rock	12-34
Figure 12-30	Proposed p-y Criterion for Strong Rock	12-35
Figure 12-31	Example for Sensitivity Analysis of Stratigraphy	12-36
Figure 12-32	Basic Strain Wedge in Uniform Soil	12-38
Figure 12-33	Deflection Pattern of Laterally Loaded Long Shaft and Associated Strain	12-38
Figure 12-34	Proposed Geometry of Compound Passive Wedge	12-39
Figure 12-35	Pushover Analysis of a Column Supported on a Drilled Shaft	12-41
Figure 12-36	Broms Earth Pressures for Cohesive Soils	12-43
Figure 12-37	Broms Pressure, Shear, Moment Diagrams for Cohesive Soils	12-43
Figure 12-38	Broms Pressure, Shear, Moment Diagrams for Cohesionless Soils	12-46
Figure 12-39	Secant, Tangent, and Soldier Pile Walls	12-47
Figure 12-40	Geometry for Drilled Shaft Wall	12-49
Figure 12-41	Simplified Earth Support Diagram for a Cantilever Wall using Effective Stress Strength	12-53
Figure 12-42	Example of Drilled Shaft Wall Problem	12-53
Figure 12-43	Earth Pressure Diagram for Drilled Shaft Wall Example Problem	12-55
Figure 12-44	Analysis of Drilled Shafts in Moving Soil	12-59
Figure 12-45	Spreading the Displaces Foundation with Soil	12-60
Figure 13-1	Generalized Load Transfer Behavior of Drilled Shaft in Compression	13-2
Figure 13-2	Flow Chart, Recommended Procedure for Axial Load Design	13-4
Figure 13-3	Idealized Geomaterial Layering for Computation of Compression Resistances	13-6
Figure 13-4	Frictional Model of Side Resistance, Drilled Shaft in Cohesionless Soil	13-11
Figure 13-5	Subsurface Profile and Drilled Shaft for Illustrative Example 13-1	13-14

Figure 13-6	Soil Profile and Trial Shaft for Illustrative Example 13-2	13-18
Figure 13-7	Base Resistance Factor for Rock	13-22
Figure 13-8	Ground Profile and Trial Shaft for Illustrative Example 13-3	13-26
Figure 13-9	Factor $\alpha$ for Cohesive IGM	13-27
Figure 13-10	Normalized Load-Displacement Curve, Drilled Shaft in Axial Compression	13-30
Figure 13-11	Idealized Subsurface Profile and Drilled Shaft Trial Dimensions	13-33
Figure 13-12	Mechanistic Model of Axially Loaded Drilled Shaft	13-38
Figure 13-13	Axially Loaded Shaft in Rock or Very Hard Geomaterial, Elastic Analysis	13-39
Figure 13-14	Typical Loading Combination Resulting in Uplift	13-41
Figure 13-15	Forces and Idealized Geomaterial Layering for Computation of Uplift Resistance	13-41
Figure 13-16	Components of Scour Affecting Bridge Supports on Deep Foundations	13-43
Figure 13-17	Flow Charts for Hydrology, Hydraulics, and Scour Analysis	13-45
Figure 13-18	Illustration of Scour Prism and Effects on Drilled Shaft	13-47
Figure 13-19	Downdrag on a Drilled Shaft Caused by Soil Settlement	13-50
Figure 13-20	Common Sources of Downdrag at Drilled Shaft Supported Bridge Abutments	13-50
Figure 13-21	Mechanics of Downdrag	13-51
Figure 13-22	Idealized Example of a Drilled Shaft in Expansive Ground	13-60
Figure 13-23	Use of embedded structural shape with weak concrete, Procedure B	13-62
Figure 13-24	Axial Force Effects and Resistances for Design of Drilled Shafts by Procedure C	13-63
Figure 14-1	Group of Drilled Shafts During Construction of the Benetia-Martinez Bridge near San Francisco	14-1
Figure 14-2	Group Versus Single Shaft	14-2
Figure 14-3	Overlapping Zones of Influence in a Frictional Pile Group	14-4
Figure 14-4	Block Type Failure Mode	14-6
Figure 14-5	Efficiency ( $\eta$ ) vs. Center-to-Center Spacing ( $s$ ), Normalized by Shaft Diameter ( $B_{\text{shaft}}$ ), for Under Reamed Model Drilled Shafts in Compression in Moist, Silty Sand.	14-7
Figure 14-6	Relative Unit Side and Base Resistances for Model Single Shaft and Typical Shaft in a Nine-Shaft Group in Moist Alluvial Silty Sand	14-7
Figure 14-7	Axial Resistance from FE Model Results of Bored Pile Groups	14-8
Figure 14-8	Deeper Zone of Influence for End Bearing Shaft Group than for a Single Shaft	14-10
Figure 14-9	Equivalent Footing Concept for Pile Groups	14-13
Figure 14-10	Pressure Distribution Below Equivalent Footing for Pile Group	14-14
Figure 14-11	Typical $e$ versus $\log p$ Curve from Laboratory Consolidation Testing	14-15
Figure 14-12	The P-Multiplier Concept	14-17
Figure 14-13	Example Plots of Lateral Load Response by Row Position	14-19
Figure 14-14	Simple Static Analysis of a 2 x 2 Group	14-21
Figure 14-15	Simple Static Analysis of a 2 x 3 Group	14-23
Figure 15-1	Flowchart of Major Steps for Analysis of Drilled Shafts for Earthquake Effects	15-4
Figure 15-2	Response Spectrum for Determination of Seismic Response Coefficient	15-6
Figure 15-3	Relationship Between Corrected Blow Count and Undrained Residual Strength ( $S_r$ ) from Case Studies	15-11
Figure 15-4	Design Impact Force, Ship Colliding with Bridge Pier	15-16
Figure 15-5	Response Spectrum for Determination of Seismic Response Coefficient	15-12
Figure 15-6	Relationship Between Corrected Blow Count and Undrained Residual Strength ( $S_r$ ) from Case Studies	15-17
Figure 15-7	Design Impact Force, Ship Colliding with Bridge Pier	15-21
Figure 16-1	Flow Chart for Structural Design	16-2
Figure 16-2	Transverse (Confinement) Reinforcement Details	16-7
Figure 16-3	Interaction Diagram for a Reinforced Concrete Column (a-h)	16-9
Figure 16-4	Nominal and Factored Interaction Diagrams	16-11
Figure 16-5	Variation of $\phi$ with Net Tensile Strain, $\epsilon_t$ and $d_t/c$ for Grade 60 Reinforcement	16-12



Figure 16-6	Illustration of Terms $b_v$ , $d_v$ and $d_c$ for Circular Sections	16-14
Figure 16-7	Sample Elevation of Drilled Shaft without Casing	16-16
Figure 16-8	Typical Sections without Casing	16-17
Figure 16-9	Comparison of Moment and Shear for a Cantilevered Column and a Socketed Drilled Shaft	16-20
Figure 16-10	Sample Elevation with Casing	16-22
Figure 16-11	Typical Section with Casing	16-23
Figure 16-12	Typical Underream	16-24
Figure 16-13	Tensile Stress Contours for Flat-bottom Bell	16-25
Figure 17-1	Kentledge Static Load Tests with Bi-directional Test and Rapid Load Test	17-1
Figure 17-2	Proof Test on Production Shafts can Verify Axial Resistance	17-5
Figure 17-3	Instrumental Research Load Tests	17-7
Figure 17-4	Observation of Test Shaft Excavation Helps Define Geologic Condition	17-10
Figure 17-5	Example Borehole Calipers & Logs; Mechanical and Sonic	17-12
Figure 17-6	Unit Side Shear vs Displacement for Drilled Shaft Sockets in Rock of Moderate Roughness with $q_u = 450$ psi	17-14
Figure 17-7	Computed Relationship Between Shaft Diameter and Maximum Unit Side Shear Resistance for Rock Sockets	17-15
Figure 17-8	“Chicago Method” Load Test using Bi-directional Cell	17-15
Figure 17-9	Conventional Static Load Test on a Drilled Shaft	17-17
Figure 17-10	4,000 ton Capacity Reaction System	17-18
Figure 17-11	5,700 ton Capacity Load Test in Taiwan	17-18
Figure 17-12	Bi-Directional Testing Schematic	17-20
Figure 17-13	Example Test Result from Bi-Directional Test	17-21
Figure 17-14	O-Cell Test with Added Reaction System	17-21
Figure 17-15	Multiple-Level Arrangement for O-cells	17-22
Figure 17-16	Single O-Cell and Multiple O-Cell Assembly and Multi-Level O-Cell Assembly	17-23
Figure 17-17	Construction Of Equivalent Top-Loaded Settlement Curve	17-26
Figure 17-18	Top Down and O-Cell Load Test at a Soil Site	17-27
Figure 17-19	Effect of “Shoulder” at Top of Rock	17-27
Figure 17-20	Average Compressive Load in Shaft During Top Down and O-Cell Loading	17-28
Figure 17-21	Analytical Model Results for O-Cell Loading in a Rock Socket	17-28
Figure 17-22	Analytical Model Results for O-Cell Loading in a Rock Socket	17-29
Figure 17-23	Comparison of Rapid Load and Hammer Blow	17-31
Figure 17-24	Conceptual Sketch of the Statnamic Rapid Load Test	17-32
Figure 17-25	Statnamic Loading Devices	17-32
Figure 17-26	Schematic Diagram of Statnamic Loading Apparatus	17-33
Figure 17-27	Statnamic Loading Apparatus	17-34
Figure 17-28	Measurements of Force and Displacement During Statnamic Loading	17-34
Figure 17-29	Force-Time Measurements for a Drilled Shaft	17-35
Figure 17-30	Single Degree of Freedom Model of a Statnamic Test	17-36
Figure 17-31	Statnamic Load versus Displacement	17-37
Figure 17-32	Computed Damping Coefficient, $c$	17-37
Figure 17-33	Segmental Unloading Point Method	17-38
Figure 17-34	Comparative Static and Statnamic Load Tests for Drilled Shafts	17-39
Figure 17-35	Dynamic Load Test of Drilled Shafts using Drop Weight and Pile Hammer	17-40
Figure 17-36	Transducers for Measurement of Force and Acceleration Photos courtesy of Pile Dynamics, Inc.	17-42
Figure 17-37	Signal Matching Concept	17-43
Figure 17-38	Computational Model of Shaft/Soil System	17-44
Figure 17-39	Factors Most Influencing CAPWAP Force Matching	17-45

Figure 17-40	Impedance Profile of the Drilled Shaft is Required	17-45
Figure 17-41	CAPWAP Calculated Load Cycles for Four Blows on a 6ft Diameter Shaft	17-46
Figure 17-42	Arrangement for Testing a Drilled Shaft under Uplift Loading	17-48
Figure 17-43	Location of Reaction Mats Relative to Uplift Shaft in Rock	17-49
Figure 17-44	Uplift Shafts in Tension versus Compression	17-50
Figure 17-45	Hydraulic Jacks for Static Load Tests	17-51
Figure 17-46	Dial Gauges	17-52
Figure 17-47	Telltails for Measurement of Displacement Below Shaft Top	17-54
Figure 17-48	Sister-bar Mounted Strain Gauges Placed in Drilled Shaft Reinforcement	17-55
Figure 17-49	Resistance Type Strain Gauge	17-56
Figure 17-50	Vibrating Wire Type Strain Gauge	17-57
Figure 17-51	Fiber Optic Strain Gauge with Bragg Grating	17-57
Figure 17-52	Example Plot of Force vs Elevation for a Top-Down Load Test	17-59
Figure 17-53	Example Plot of Unit Load Transfer Curves	17-60
Figure 17-54	Data from an Instrumented Field Load Test	17-60
Figure 17-55	Schematic Diagram of Lateral Test where Scourable Overburden is Present	17-63
Figure 17-56	Conventional Static Lateral Load Test Setup	17-65
Figure 17-57	Clevis Bracket and Load Cell Mount for Lateral Loading	17-66
Figure 17-58	Cyclic Lateral Load Test Setup	17-66
Figure 17-59	Bi-directional Lateral Testing Apparatus Using Embedded O-cells	17-67
Figure 17-60	Rapid Lateral Load Test	17-68
Figure 17-61	Long Travel Displacement Transducer	17-69
Figure 17-62	Measurements of Lateral Displacement in a Lateral Test Shaft below Grade Using an Inclinometer	17-70
Figure 17-63	In-Place Inclinometer Sensors	17-70
Figure 17-64	Down-hole Accelerometer for Displacement Measurement During Rapid Lateral Load Test	17-71
Figure 17-65	Strain Gauges to Measure Bending Moments	17-71
Figure 19-1	Setting Up a Sonic Caliper for Profiling a Drilled Shaft	19-8
Figure 19-2	Shaft Inspection Device for Visual Inspection of the Shaft Bottom in a Wet Excavation	19-9
Figure 20-1	Diagram of Crosshole Acoustic Logging System	20-3
Figure 20-2	Crosshole Sonic Log for a Shaft with a Known Defect	20-5
Figure 20-3	Reinforcing Cage with Steel Access Tubes for CSL Testing	20-7
Figure 20-4	Crosshole Tomography Test	20-7
Figure 20-5	2-D Tomograms for a Shaft with Four Access Tubes	20-8
Figure 20-6	Gamma-gamma Logging (GGL) in a Drilled Shaft	20-10
Figure 20-7	Placement of PVC Access Tube Inside Reinforcing Cage	20-11
Figure 20-8	Results from Gamma-gamma Logging of a Drilled Shaft with Four Access Tubes	20-12
Figure 20-9	Defect similar to the defect that produced the logs in Figure 20-8	20-12
Figure 20-10	Sonic Echo Method	20-14
Figure 20-11	A Severe Defect Likely to be Detected by Sonic Echo Testing	20-16
Figure 20-12	Ideal Response Curve for the Impulse-response or Vibration Test	20-17
Figure 20-13	Examples of Impedance Logs	20-19
Figure 20-14	Concrete Cores Drilled Shafts	20-21
Figure 20-15	Downhole Camera Used by Caltrans	20-23
Figure 20-16	Drilled Shaft Acceptance Criteria Incorporating NDE	20-25
Figure 21-1	Flow Chart of the Evaluation and Remediation Process	21-2
Figure 21-2	Different Relative Stiffness of Different Deep Foundation Elements Affects Shear Forces in Cap	21-10

Figure 21-3	Use of Straddle Shafts to Replace an Existing Foundation	21-10
Figure 21-4	Use of Sister Shafts to Supplement an Existing Foundation	21-11
Figure 21-5	Use of Micropiles Drilled Through Existing Drilled Shaft	21-12
Figure 21-6	Use of Micropiles to Supplement an Existing Foundation	21-13
Figure 21-7	Excavation and Replacement of Defective Concrete Using Drilling Tool within the Cage and Hand Methods	21-13
Figure 21-8	Use of a Steel Section Cast into a Drilled Shaft to Form Structural Bridge	21-14
Figure 21-9	Hydrodemolition Tools	21-16
Figure 21-10	Downhole Camera View of Access Hole after Hydrodemolition	21-16
Figure 21-11	Concrete Core Through Grouted Concrete Repair	21-16
Figure 21-12	Jet Grouting and Illustration	21-17
Figure 21-13	Jet Grouting Application for Drilled Shaft Repair	21-18

Archived

This page is intentional left blank.

Archived

## LIST OF TABLES

Table 1-1	Advantages and Limitations of Drilled Shafts	1-16
Table 2-1	Summary of Field & Laboratory Methods for Geomaterial Characteristics	2-2
Table 2-2	Sources and Use of Preliminary Project and Subsurface Information	2-4
Table 2-3	Recommended Minimum Frequency of Borings, Drilled Shaft Foundations for Bridges	2-10
Table 2-4	Methods of Boring and Sampling	2-13
Table 2-5	Common Sampling Methods in Soil	2-14
Table 2-6	Description of Rock Quality Based on RQD	2-18
Table 2-7	Description of Rock Core for Engineering Characterization.	2-19
Table 2-8	Information Used for Drilled Shaft Constructability	2-23
Table 2-9	Information Included in Geotechnical Investigation Report	2-25
Table 3-1	In-situ Tests in Soil with Application to Drilled Shaft Design	3-3
Table 3-2	Soil Index Properties Used in Drilled Shaft Foundation Engineering	3-8
Table 3-3	Relationship Between Relative Density, SPT N-Value, and Drained Friction Angle of Cohesionless Soils	3-10
Table 3-4	Unconfined Compressive Strength of Particles for Rockfill Grades Shown in Figure 3-5	3-11
Table 3-5	Common In-Situ Tests Used for Interpretation of $s_u$	3-13
Table 3-6	Elastic Properties of Soils	3-17
Table 3-7	In-Situ Tests Relevant to Shafts in Rock	3-24
Table 3-8	Values of the Constant $m_i$ by Rock Group	3-29
Table 3-9	Correlations Between GSI and Rock Mass Modulus	3-30
Table 3-10	Values of Coefficient of Variation, $V$ , for Geotechnical Properties and In-Situ Tests	3-32
Table 7-1	Recommended Mineral Slurry Specifications for Drilled Shaft Construction	7-28
Table 7-2	Recommended Polymer (PAM) Slurry Specifications for Drilled Shaft Construction	7-28
Table 8-1	Properties of Reinforcing Steel for Concrete Reinforcement	8-2
Table 8-2	Weights and Dimensions of Deformed Bars (Customary)	8-2
Table 9-1	Example of Mixture Proportions for Workable Drilled Shaft Concrete	9-32
Table 9-2	Examples of Mixture Proportions for "SCC" Type Drilled Shaft Concrete	9-32
Table 9-3	Typical Proportions of Pozzolanic Additives	9-34
Table 9-4	Typical Proportions of Some TxDOT Pre-approved Air Entraining Chemical Admixtures	9-35
Table 10-1	Reliability Index in Terms of Probability of Failure	10-5
Table 10-2	AASHTO (2007) Limit States for Bridge Design	10-7
Table 10-3	Load Combinations and Load Factors	10-8
Table 10-4	Load Factors and Permanent Loads	10-8
Table 10-5	Summary of Resistance Factors for LRFD of Drilled Shaft Foundations	10-12
Table 12-1	Recommended Resistance Factors for Geotechnical Strength Limit State for Lateral Loading of Drilled Shafts	12-25
Table 12-2	Friction Angle for Mass Concrete Against Soil	12-50
Table 12-3	Approximate Values of Relative Movements Required to Reach Active or Passive Earth Pressure Conditions	12-57
Table 13-1	Geomaterial Properties Required for Drained and Undrained Axial Resistances	13-7
Table 13-2	Bearing Capacity Factor $N_c^*$	13-19
Table 13-3	Modulus Ratio from RQD	13-21
Table 13-4	Method of Identifying Potentially Expansive Soils	13-59
Table 14-1	Efficiency ( $\eta$ ) for Model Drilled Shafts Spaced 3 Diameters Center-to-Center in Various Group Configurations in Clayey Sand (Senna et al, 1993)	14-8

Table 14-2	Recommended P-Multiplier $P_m$ Values for Design by Row Position	14-18
Table 15-1	Seismic Site Classification Based on Subsurface Profile	15-5
Table 15-2	Seismic Site Factors	15-5
Table 15-3	Seismic Risk Zones	15-7
Table 15-4	Load Combinations and Load Factors for Extreme Event	15-17
Table 16-1	Maximum Net Bearing Stresses for Unreinforced Concrete Underreams	16-4
Table 16-2	Minimum Yield Strengths for Permanent Steel Casing	16-25
Table 17-1	Summary of Benefits and Limitations of Design-Phase Field Load Tests	17-3
Table 17-2	Summary of Benefits and Limitations of Proof Tests on Production Shafts	17-4
Table 17-3	Summary of Benefits and Limitations of Proof Tests on Production Shafts	17-6
Table 17-4	Rate Factors for Different Soil Types	17-38
Table 19-1	Drilled Shaft Inspector's Checklist	19-4
Table 19-2	Common Problems Encountered During Drilled Shaft Construction	19-13
Table 20-1	Common NDT Methods for Drilled Shafts	20-2
Table 20-2	Concrete Condition Rating Criteria	20-5
Table 22-1	Low-Bid Table for Drilled Shafts, Texas DOT, Statewide	22-5
Table 22-2	Low-Bid Table for Drilled Shafts, Texas DOT; District 12 Only	22-6
Table 22-3	Average Low-Bid Prices for Drilled Shafts, 2007, Caltrans	22-7
Table 22-4	Summary Statistics on Drilled Shaft Contract, Ellis County, TX	22-11

# CHAPTER 1

## OVERVIEW - SELECTION AND USE OF DRILLED SHAFT FOUNDATIONS FOR TRANSPORTATION STRUCTURES

### 1.1 INTRODUCTION - PURPOSE AND ORGANIZATION OF MANUAL

This publication is intended to provide a resource for engineers responsible for the selection and design of drilled shaft foundations for transportation structures and as a text for use with the three day short course on the subject presented by the National Highway Institute (Course No. 132014). This document represents an updated edition of the very successful Federal Highway Administration publication on drilled shaft foundations co-authored by the late Michael O'Neal and late Lymon Reese, published in 1988 and revised and republished in 1999. The major changes to the manual include:

- The design approach follows the format of Load and Resistance Factor Design (LRFD) methods, consistent with the latest (2009) AASHTO standards.
- New information on site investigation and characterization for construction and design of drilled shafts, especially with respect to rock.
- New information on the evolution of construction techniques and materials, reflecting the increasing sizes and demands on drilled shaft foundations. Guidelines on the design and use of base grouting and new information on self consolidating concrete (SCC) materials in drilled shafts is included.
- Design for lateral and axial loading is expanded, and some design methods are revised. The design chapters include more information relating to design for extreme event loads and other applications for drilled shafts such as retaining walls or foundations with lateral movement of soil mass.
- Sections on load and integrity testing are expanded, and reflect the increased maturity of the use of field testing methods since the previous edition of the manual.
- The guide specifications are based on a 2009 balloted version by AASHTO Technical Committee T-15, and reflect the development of a consensus document developed with the participation and agreement of FHWA and ADSC: The International Association of Foundation Drilling.
- The section on remediation measures is expanded and includes references to established procedures that have been used for repair of drilled shafts.

This manual is intended to provide guidance with respect to recommended practice for general design and construction in the U.S. rather than comprehensive coverage of every design and construction method which might be employed. Local practice adapted to unusual circumstances or to specific local geologic conditions may evolve differently from some specific recommendations outlined in this manual. Although the recommendations given in this publication represent generally recommended practice as of the time of this writing, it is not intended to preclude deviations from these recommended practices that are based on demonstrated performance and sound engineering.

The manual is organized in several major sections similarly to the presentation of the short course materials.

- **Overview and Applications.** This chapter (1) provides an overview of drilled shaft foundations, along with a discussion of general applications of the technology for transportation structures. This information is intended to provide a general basis for understanding the subsequent chapters and to aid designers in identifying those applications for which drilled shaft foundations might be appropriate.
- **Needed Geotechnical Information.** Chapters 2 and 3 describe the aspects of geotechnical site characterization and determination of material properties specifically required for construction and design of drilled shafts
- **Construction.** Chapters 4 through 9 explain construction methods and materials. It is very important that design professionals understand construction of drilled shafts in order to produce constructible and cost-effective drilled shaft designs.
- **Design.** Chapters 10 through 16 present guidelines for design of drilled shafts for axial and lateral loadings using the principles of LRFD based design.
- **Quality Assurance.** Chapters 17 through 22 cover issues relating to specification, inspection, testing, and quality assurance as well as cost estimation.

The manual also includes a comprehensive and holistic example of a bridge foundation designed with drilled shafts. The example, illustrated below in Figure 1-1, is an intermediate pier of a bridge across a river, with the bent supported by three columns. The new bridge replaces an adjacent existing structure founded on driven piles. The drilled shaft design is to consist of an individual shaft supporting each of the three columns. Details of the project requirements, subsurface information, and foundation design are presented in total in Appendix A of this manual and referenced throughout the manual where relevant aspects of design issues are discussed.

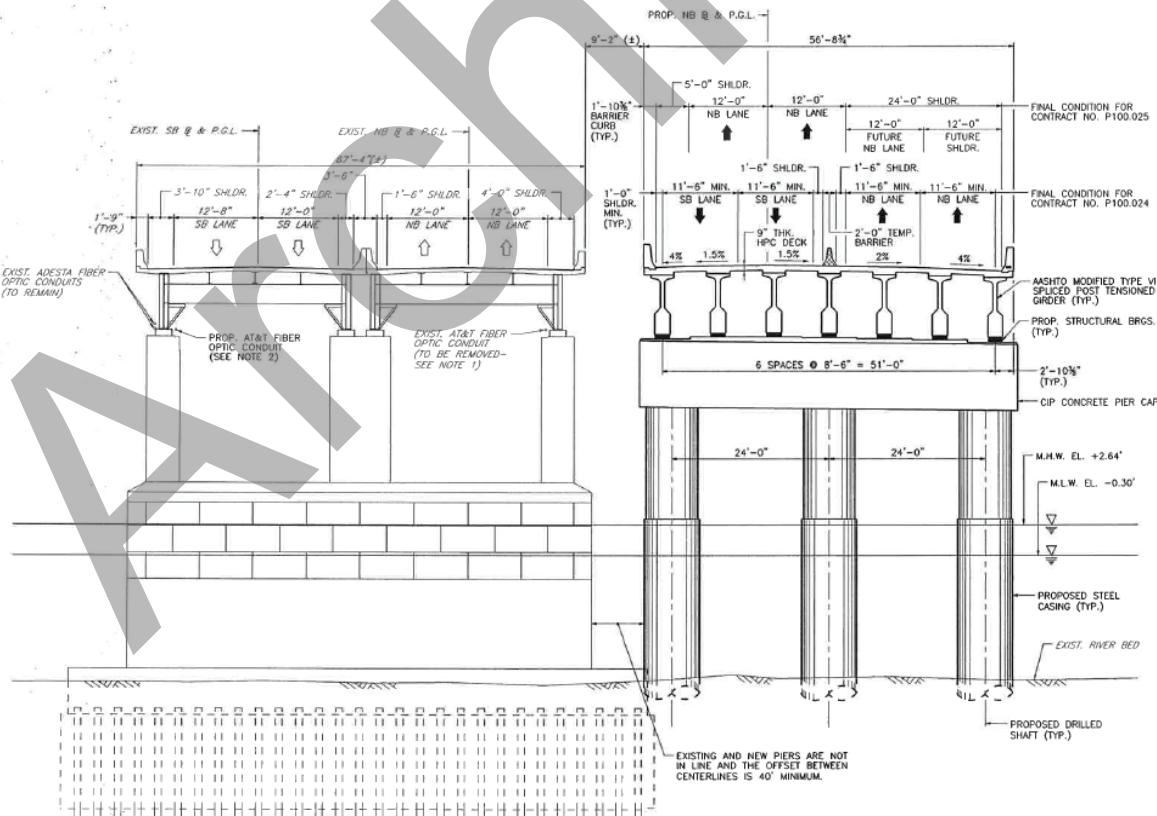


Figure 1-1 Holistic Design Example



## 1.2 TYPES OF DEEP FOUNDATIONS

Drilled shaft foundations are broadly described as cast-in-place deep foundation elements constructed in a drilled hole that is stabilized to allow controlled placement of reinforcing and concrete. Several other types of deep foundations are employed in transportation works, as described below with distinctions from drilled shafts.

- Driven piles are prefabricated structural elements which are installed into the ground with a pile driving hammer. Driven piles have been used to support structures for thousands of years and in present times steel H, pipe, and prestressed concrete piles are commonly used for transportation structures. Guidelines for design and construction of driven pile foundations are provided by Hannigan et al in FHWA NHI-05-042 (2006). Driven piles are typically 12 to 36 inches in diameter or width and thus smaller in size than drilled shafts. Driven piles displace the soil into which they are driven and cannot penetrate hard materials or rock. In soft or caving soils there is no concern for stability of a hole.
- Micropiles are drilled piles which are typically less than 12 inches diameter and constructed using a high strength steel rod or pipe which is grouted into the bearing formation. Guidelines for design and construction of micropiles are provided by Armour et al in FHWA-SA-97-070 (2000). These piles can be drilled into even hard rock and achieve very high axial resistance for a very small structural member. Micropiles are favored in conditions where the small size is an advantage and where lightweight, mobile drilling equipment must be employed.
- Continuous flight auger piles and drilled displacement piles are drilled pile foundations which are typically 12 to 30 inches in diameter. These piles are distinguished from drilled shafts in that the pile is formed by screwing the continuous auger or displacement tool into the ground and then grouting or concreting through the hollow center of the auger; thus there is not an open hole at any time during the construction process. Guidelines for the design and construction of these types of piles are provided by Brown et al (2007).

All of the types of piles described above are most often used in groups connected at the pile top with a reinforced concrete pilecap. Drilled shafts are distinguished from other types of piles in that drilled shafts are often substantially larger in size, frequently used as a single shaft support for a single column without a cap, and often installed into hard bearing strata to achieve very high load resistance in a single shaft. A description of drilled shafts and applications which may favor the use of drilled shaft foundations follows.

## 1.3 DRILLED SHAFT FOUNDATIONS – DESCRIPTION AND HISTORY

Drilled shaft foundations are formed by excavating a hole, typically 3 to 12 feet in diameter, inspecting the soil or rock into which the foundation is formed, and constructing a cast-in-place reinforced concrete foundation within the hole. The foundation as constructed supports axial forces through a combination of side shearing and end bearing resistance. The large diameter reinforced concrete member is also capable of providing substantial resistance to lateral and overturning forces as illustrated on Figure 1-2. Drilled shafts for transportation structures are fairly commonly used to depths of up to 200 ft in the U.S., but can extend to depths of as much as 300 ft or more.

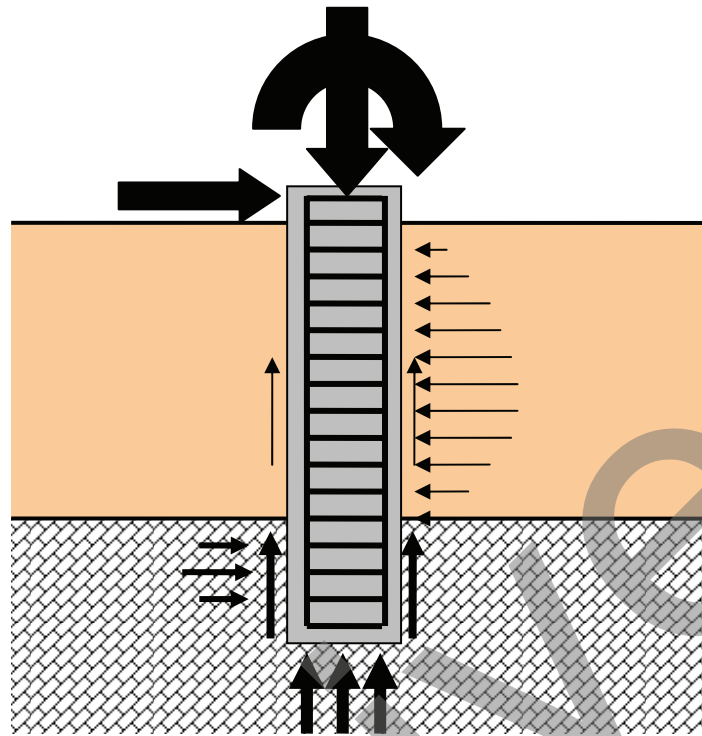


Figure 1-2 Schematic of Axial and Lateral Resistance of a Drilled Shaft

Drilled shafts are also referred to by other names, including drilled piers, caissons, cast-in-drilled-hole piles (CIDH - Caltrans terminology), and bored piles (Europe). The common reference to these foundations as “caissons” reflects the history of development of drilled shaft foundations.

The term “caisson” is more accurately used to reference very large footings which are sunk into position by excavation through or beneath the caisson structure, and the use of drilled shafts evolved in many respects from caisson construction. Caisson construction has been used for hundreds of years, and was pioneered in the U.S. bridge construction in 1869 by James Eads in St. Louis and subsequently in the 1870’s by Roebling on the Brooklyn Bridge (McCullough, 1972). A diagram of caisson construction is shown on Figure 1-3 from one of the world’s most famous bridges, the Firth of Forth crossing in Scotland. These caissons were constructed as “pneumatic caissons” in which air pressure was maintained below the caisson as it sunk to prevent water inflow into the chamber below where workers excavated beneath the caisson cutting edge to sink the caisson to the required bearing stratum. Pneumatic caissons are rare today because of safety issues, but open well caissons are still occasionally used for bridges in deep water environments.

Open well caissons typically consist of a box open at both top and bottom, with dredge wells for excavating the soil through the caisson to sink it into place. Several large bridges have recently been constructed on large rectangular “open-well” caissons including the new Tacoma Narrows bridge and the Mississippi River crossing at Greenville, MS (Figure 1-4).

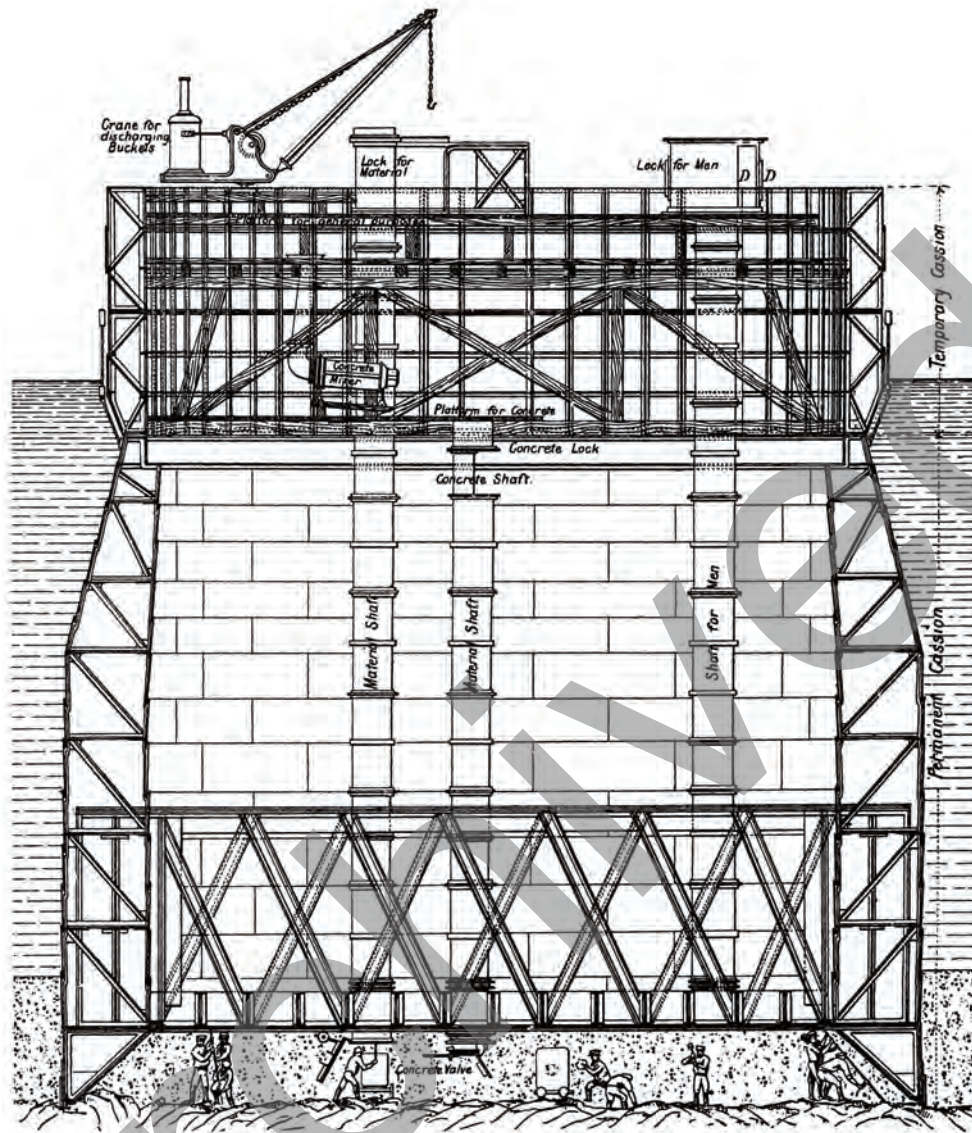


Figure 1-3 Pneumatic Caisson for Firth of Forth Bridge (Mackay, 1990)

Smaller, circular caissons or shafts were used to support building structures and some transportation structures in the early 1900's in several large cities including Kansas City, Chicago, Boston, and New York. These early forms of drilled shafts were usually excavated by hand. The first known building supported on caissons of this type is the City Hall in Kansas City, which was constructed in 1890 (Hoffmann, 1966). Because of concern that timber piles might rot, the city building superintendent, S.E. Chamberlain designed the foundations to consist of 92 caissons, 4½ ft diameter, placed to bear on limestone at a depth of around 50 ft. The excavation was supported by cylindrical sections of 3/16" boiler plate "to prevent the collapse of earth surrounding the excavation" (Chamberlain, 1891), and backfilled not with concrete but with vitrified brick laid in hydraulic cement. A drawing from the Kansas City Star newspaper is reproduced in Figure 1-5 below. Chamberlain's description of this approach at the Annual Convention of the American Institute of Architects in Chicago in the fall of 1890 may have contributed to the adoption of this technique for several structures in that city soon afterward.

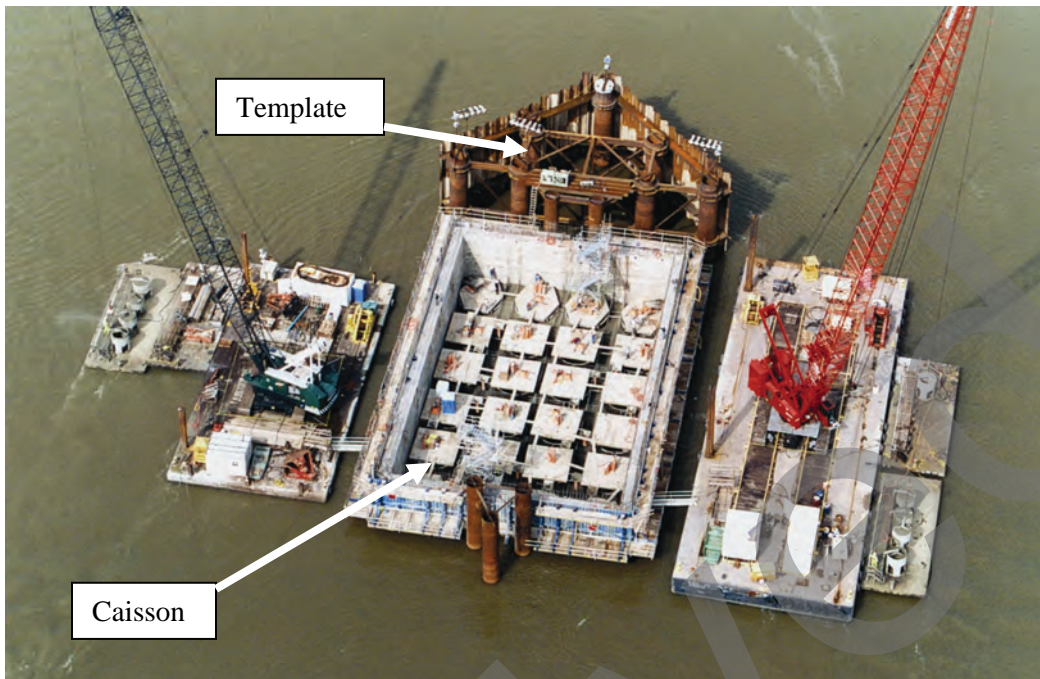


Figure 1-4 Caisson Construction for Greenville Bridge (Jacobson, 2007)

Fig. 2. Caisson being lowered into place for the City Hall, drawing from the *Star*, 19 September 1892 (courtesy State Historical Society of Missouri).



Figure 1-5 “Caisson” Foundation Construction in Kansas City (Hoffmann, 1966)

Several notable buildings in Chicago which had been founded on spread footings had suffered damaging settlement. The use of timber piles caused such heaving of the surrounding area that the owners of the Chicago Herald got a court injunction to stop construction of the pile foundations at the Chicago Stock Exchange building because of structural damage to their building (Rogers, 2006). The diagram at left of Figure 1-6 illustrates a foundation of the type designed by William Sooy Smith for one wall of the Chicago Stock Exchange building in 1893. The shafts were constructed as circular excavations with tongue and grooved timber lagging which was driven ahead of the excavation and braced with iron hoops. This method of excavation with timber lagging in a circular form became known as the “Chicago Method”. These types of foundations are not actually caissons in the true sense of the word, but the term stuck and is still used today even for modern drilled shaft construction.

The diagram at the right of Figure 1-6 illustrates a “Gow caisson” of the type pioneered by Col. Charles Gow of Boston who founded the Gow Construction Co. in 1899. The telescoping casing forms could be recovered during concrete placement. In the 1920’s, the Gow Company built and used a bucket-type auger machine which was electrically powered and mounted on the turntable frame of the crawler tractor of a crane (Greer and Gardner, 1986), thus promoting the development of machine-drilled shafts.

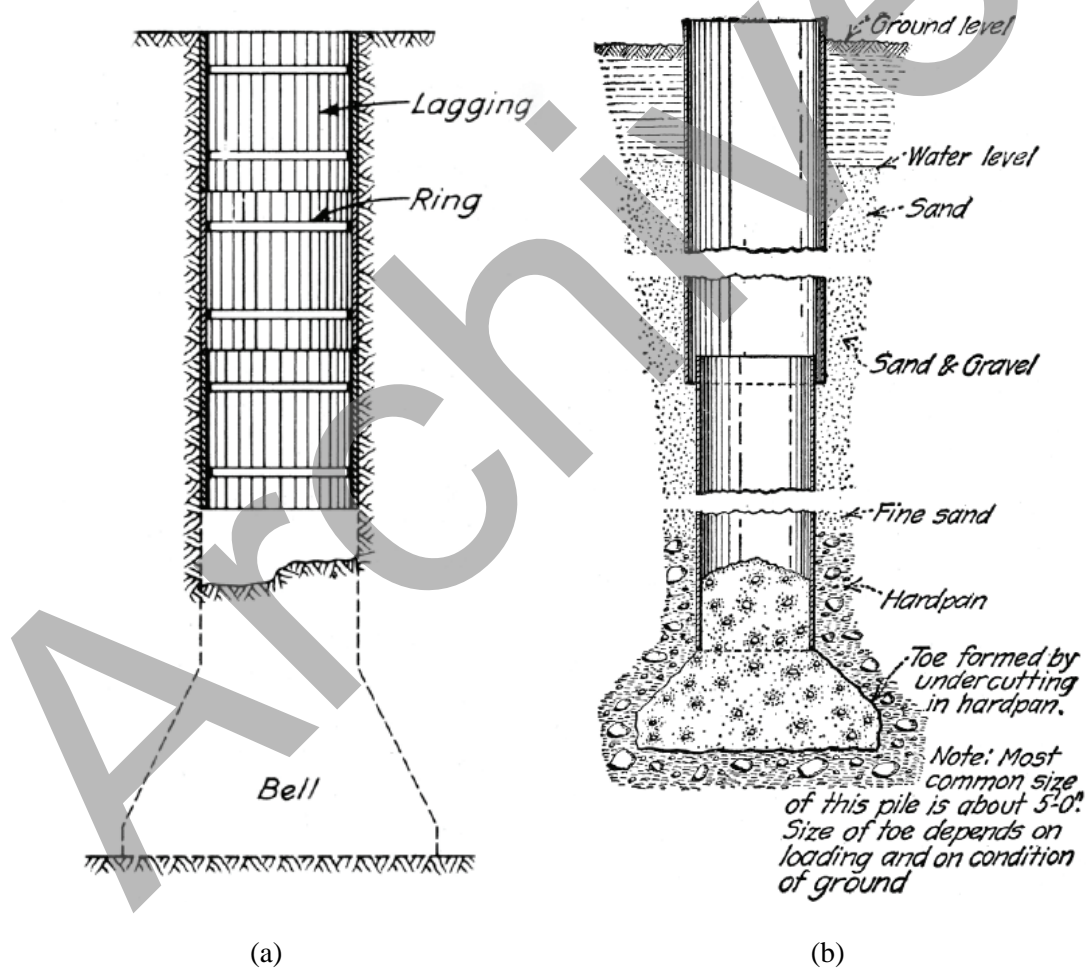


Figure 1-6 Early “Caisson” Foundations (Rogers, 2006); (a) “Chicago Method” and (b) “Gow Caisson”

Although there has been a significant evolution of the drilled shaft industry over the past 40 years to the type of construction and design which is prevalent today (2009), machine drilled shafts became more widespread during the 1930's and became increasingly used during the building boom after World War II. The A.H. Beck Company began using drilled shafts in 1932 (photo in Figure 1-7) and, along with McKinney Drilling (founded 1937), were some of the pioneers of the drilled shaft industry in Texas. Augered uncased holes smaller than 30 inch diameter were common, and sometimes tools were employed to rapidly cut an underream or bell. In California, "bucket-auger" machines were more common, using a bottom dumping digging bucket to dig and lift soils rather than an auger.



Figure 1-7 An Early Drilled Shaft Rig and Crew (courtesy A.H. Beck & Co.)

Modern drilled shaft construction techniques are described in Chapters 4 through 9 of this manual and include equipment ranging from simple truck mounted equipment used to auger holes not much different from that used in the 1940's to modern machines capable of drilling large, deep shafts into very hard materials (Figure 1-8). Workers do not generally enter the excavation and underwater concrete placement is commonly employed so that a dry excavation is not required. Techniques for testing to verify geotechnical strength and structural integrity are common so that drilled shafts can be used with a high degree of confidence in the reliability of the foundation.



Figure 1-8 Typical Modern Drilled Shaft Rigs

The photo in Figure 1-9 shows construction of the main pylon foundation for a new cable-stayed Missouri River bridge in Kansas City, 108 years after the pioneering first use of drilled shafts for the City Hall. The equipment and construction methods have advanced far beyond the original concepts proposed in 1890 but the basic idea is the same: to support the structure on bedrock below weak soils using small, economically constructed “caisson” foundations. The history of drilled shafts is thus seen to have come full circle: the large caisson construction techniques used for bridges were adapted to construct small diameter “caissons” to support buildings which lead back to the use of large drilled shafts for bridges and other transportation structures.



Figure 1-9 Construction of 12-ft Diameter Drilled Shafts for the Main Pylon Foundation, Christopher S. Bond Bridge, Kansas City (photo by Gary Naugle, MoDOT)

The development of improved equipment, materials, and methods for design and testing have allowed the cost effective use of drilled shafts in a greater variety of applications and with greater reliability than was ever before possible. The following sections provide an overview of some applications of drilled shafts for transportation structures along with factors affecting the selection of drilled shafts as a deep foundation alternative.

## **1.4 SELECTION OF DRILLED SHAFTS**

Drilled shafts can be installed in a variety of soil and rock profiles, and are most efficiently utilized where a strong bearing layer is present. When placed to bear within or on rock, extremely large axial resistance can be achieved in a foundation with a small footprint. The use of a single shaft support avoids the need for a pile cap with the attendant excavation and excavation support, a feature which can be important where new foundations are constructed near existing structures. Foundations over water can often be constructed through permanent casing, avoiding the need for a cofferdam. Drilled shafts can also be installed into hard, scour-resistant soil and rock formations to found below scourable soil in conditions where installation of driven piles might be impractical or impossible. Drilled shafts have enjoyed increased use for highway bridges in seismically active areas because of the flexural strength of a large diameter column of reinforced concrete. Drilled shafts may be used as foundations for other applications such as retaining walls, sound walls, signs, or high mast lighting where a simple support for overturning loads is the primary function of the foundation.

The following sections outline some applications for the use of drilled shaft foundations in transportation structures, followed by a discussion of the advantages and limitations of drilled shafts relative to alternative foundation types.

### **1.4.1 Applications**

Drilled shaft foundations are logical foundation choices for a variety of transportation structures if the loading conditions and ground conditions are favorable. The following sections outline some of the circumstances where drilled shafts are often the foundation of choice for structural foundations.

#### **1.4.1.1 Bridge Foundations**

For foundations supporting bridge structures, conditions favorable to the use of drilled shafts include the following:

- Cohesive soils, especially with deep groundwater. For these type soil conditions, drilled shafts are easily constructed and can be very cost effective (Figure 1-10).
- Stratigraphy where a firm bearing stratum is present within 100 ft of the surface. Drilled shafts can provide large axial and lateral resistance when founded on or socketed into rock or other strong bearing strata.
- Construction of new foundations where a small footprint is desirable. For a widening project or an interchange with “flyover” ramps or other congested spaces, a single drilled shaft under a single column can avoid the large footprint that would be necessary with a group of piles. A single shaft can also avoid the cost of shoring and possibly dewatering that might be required for temporary excavations. Construction of drilled shafts can often be performed with minimal impact on nearby structures. Figure 1-11 illustrates some examples of these types of applications.





Figure 1-10 Construction of Drilled Shaft in Dry, Cohesive Soils



Figure 1-11 Drilled Shafts for Bridge Foundations where Small Footprint is Desirable

- Construction of foundations over water where drilled shafts may be used to avoid construction of a cofferdam. The photo in Figure 1-12 illustrates a two column pier under construction in a river with a single shaft supporting each column.
- Foundations with very high axial or lateral loads. The photo in Figure 1-13 shows construction of a 5-shaft group with a waterline footing for a bridge with large foundation loads in relatively deep water.



Figure 1-12 Drilled Shafts for Individual Column Support over Water



Figure 1-13 Group of Drilled Shafts for Large Loads

- Foundations with deep scour conditions where driven piles may be difficult to install. The photos in Figure 1-14 are from a bridge in Arizona. The original piles had been driven to refusal but subsequently one of the foundations had been lost due to scour.
- Construction of new foundations with restricted access or low overhead conditions. Often, high capacity drilled shaft foundations can be constructed in these circumstances with specialty equipment. Construction of new foundations for a replacement structure in advance of demolition of existing structures can be used to reduce the impact of construction on the traveling public. The photo in Figure 1-15 shows drilled shafts with low headroom.



Figure 1-14 Drilled Shafts Installed for Deep Scour Problem



Figure 1-15 Drilled Shafts with Low Headroom

### 1.4.1.2 Other Applications

Drilled shaft foundations can be particularly well adapted to use for other types of transportation structures. Due to the good strength in flexure provide by large diameter reinforced concrete columns, drilled shafts are well suited to structures where loads are dominated by overturning such as sound walls, signs, and lighting structures. In most cases, drilled shafts for these applications do not require great length and the drilling equipment used to install them may be relatively light and mobile. Some illustrations of these types of applications are provided in Figure 1-16. The design of drilled shafts for lateral and overturning forces is described in Chapter 12 of this manual.

Retaining structures may be founded on drilled shafts or even may incorporate drilled shafts into the wall itself. Conventional reinforced concrete walls may include drilled shafts supporting the wall footing, but often the shafts can be used in a single row without a footing cap and with the wall cast atop the row of shafts as illustrated on the left of Figure 1-17. Drilled shafts can also be used as soldier beams with precast panels placed between to form a wall as shown on the right.



Figure 1-16 Drilled Shafts for Soundwall (left) and Sign (right)



Figure 1-17 Drilled Shafts Used to Support Earth Retaining Structures

Drilled shafts can even be used to form a top-down wall prior to excavation as a secant or tangent pile system. Secant piles are formed by drilling alternate shafts, then subsequently drilling the primary pile by cutting into the existing shaft as shown on the left of Figure 1-18. Secant piles are useful where a seal is required. Tangent piles are typically formed adjacent to each other or with a small space between without cutting into existing piles. An aesthetic facing (precast concrete panels, or cast-in-place concrete) or shotcrete covering may be used after excavation to expose the wall.

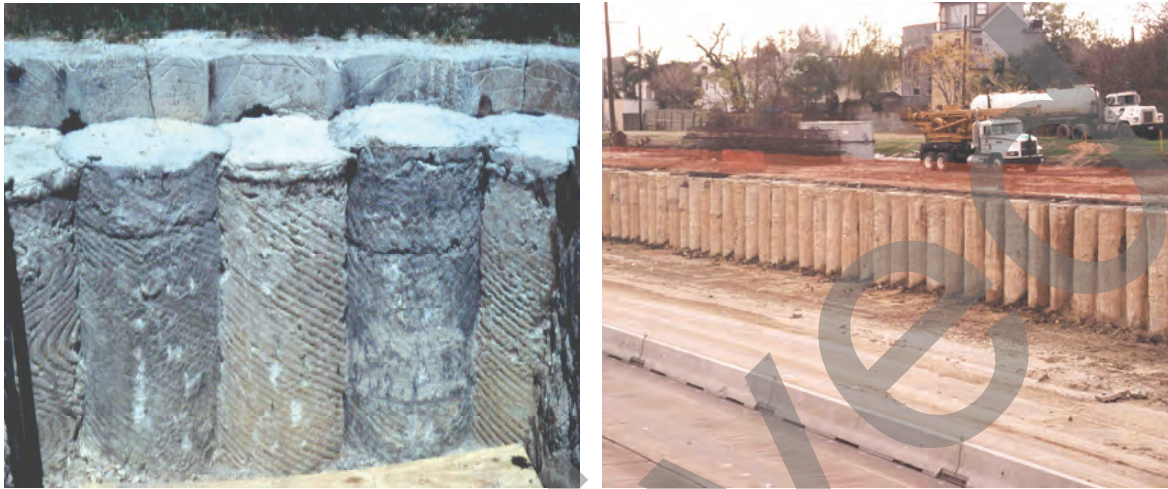


Figure 1-18 Drilled Shaft Secant Wall (left) and Tangent Wall (right)

Drilled shafts have been used in landslide stabilization schemes. A drilled shaft wall or even rows of shafts with space between can be constructed across a slip surface to provide restraining force to a sliding soil mass. Although this approach can be an expensive solution to slope stability problems, there may be applications where right-of-way or other constraints preclude grading or changes in slope geometry.

#### 1.4.2 Advantages and Limitations

Many of the advantages of drilled shafts are apparent from a review of the applications cited above. In addition, drilled shafts offer the opportunity to directly inspect the bearing material so that the nature of the bearing stratum can be confirmed. However, there is no direct measurement that can be related to axial resistance as in the case of pile driving resistance. The most significant of the limitations are related to the sensitivity of the construction to ground conditions and the influence of ground conditions on drilled shaft performance. A summary of advantages and limitations of drilled shafts compared to other types of deep foundations is provided in Table 1-1.

### 1.5 KEYS TO SUCCESSFUL USE OF DRILLED SHAFTS

Because drilled shafts are sensitive to the ground conditions and construction techniques used, it is critically important that designers be familiar with these factors so that drilled shafts are selected for use in the appropriate circumstances, the design is constructible, and the specifications and quality assurance measures are suitable to ensure that a reliable foundation is constructed. The keys to successful construction and design of drilled shafts are outlined below.

**TABLE 1-1 ADVANTAGES AND LIMITATIONS OF DRILLED SHAFTS**

<b>Advantages</b>	<b>Limitations</b>
<ul style="list-style-type: none"> <li>• Easy construction in cohesive materials, even rock</li> </ul>	<ul style="list-style-type: none"> <li>• Construction is sensitive to groundwater or difficult drilling conditions</li> </ul>
<ul style="list-style-type: none"> <li>• Suitable to a wide range of ground conditions</li> </ul>	<ul style="list-style-type: none"> <li>• Performance of the drilled shaft may be influenced by the method of construction</li> </ul>
<ul style="list-style-type: none"> <li>• Visual inspection of bearing stratum</li> </ul>	<ul style="list-style-type: none"> <li>• No direct measurement of axial resistance during installation as with pile driving</li> </ul>
<ul style="list-style-type: none"> <li>• Possible to have extremely high axial resistance</li> </ul>	<ul style="list-style-type: none"> <li>• Load testing of high axial resistance may be challenging and expensive</li> </ul>
<ul style="list-style-type: none"> <li>• Excellent strength in flexure</li> </ul>	<ul style="list-style-type: none"> <li>• Structural integrity of cast-in-place reinforced concrete member requires careful construction, QA/QC</li> </ul>
<ul style="list-style-type: none"> <li>• Small footprint for single shaft foundation without the need for a pile cap</li> </ul>	<ul style="list-style-type: none"> <li>• Single shaft foundation lacks redundancy and must therefore have a high degree of reliability</li> </ul>
<ul style="list-style-type: none"> <li>• Low noise and vibration and therefore well suited to use in urban areas and near existing structures</li> </ul>	<ul style="list-style-type: none"> <li>• Requires an experienced, capable contractor, usually performed as specialty work by a subcontractor</li> </ul>
<ul style="list-style-type: none"> <li>• Can penetrate below scour zone into stable, scour-resistant formation</li> </ul>	<ul style="list-style-type: none"> <li>• May not be efficient in deep soft soils without suitable bearing formation</li> </ul>
<ul style="list-style-type: none"> <li>• Can be easily adjusted to accommodate variable conditions encountered in production</li> </ul>	<ul style="list-style-type: none"> <li>• Requires thorough site investigation with evaluation of conditions affecting construction; potential for differing site conditions to impact costs, schedule</li> </ul>

- **Subsurface Investigation.** A thorough subsurface investigation is required not only for the design of drilled shaft foundations but also for construction. Issues related to construction of drilled shafts should be addressed at the time of the site investigation and in the subsequent report. Items such as groundwater level, relative soil permeability, rock hardness and geologic features which may affect drilling are important for planning and executing the work. Because drilled shafts are often designed to bear in hard soils or rock, characterization of these materials for design purposes can be challenging. Guidelines for site investigation and determination of geomaterial properties are described in Chapters 2 and 3.
- **Knowledge of Construction Techniques.** In order to design drilled shafts which are constructible, cost effective, and reliable, it is essential that engineers and project managers have a thorough understanding of construction methods for drilled shafts. Drilled shaft construction methods and materials are described in Chapters 4 through 9.
- **Design for Constructability and Reliability.** The performance of drilled shafts can be strongly influenced by construction, and a recurring theme throughout the design process is that constructability be considered at each step. The robust design is one which is simple to execute and construct and can accommodate variations in subsurface conditions while minimizing risk of delays or costly changes. Design aspects are described in Chapters 10 through 16. The recent development of advanced techniques for load testing drilled shafts has allowed designers to incorporate site specific testing to measure performance, reduce risk of poor foundation performance, and avoid designs which are excessively conservative, expensive, and more difficult

to construct. Load testing is described in Chapter 17. Constructible designs are more cost-effective; factors affecting cost are summarized in Chapter 22.

- **Appropriate Specifications.** Specifications set forth the contractual rules for execution of the work and must include provisions which are both constructible and which provide the required means of quality assurance in the completed project. An understanding of construction techniques and the potential influence of construction must be incorporated into specifications which are appropriate for the specific project. Guide specifications with commentary are provided in Chapter 18.
- **Quality Assurance.** Drilled shaft foundations are cast-in-place reinforced concrete structures which are sometimes constructed under difficult circumstances. In order to ensure that reliable foundations are constructed, a rigorous program of inspection and testing is essential. A discussion of inspection and tests for completed shafts is provided in Chapters 19 and 20. Techniques for repair of defects are described in Chapter 21.

## 1.6 SUMMARY

This chapter has provided an introduction to drilled shaft foundations, along with a brief history of the development of drilled shafts in the U.S. Some potential applications of drilled shafts for transportation structures are presented with advantages and limitations compared to other types of deep foundations. Finally, a summary of the keys to successful use of drilled shaft foundations emphasizes the theme of design for constructability. Details on the selection, design, construction, and inspection of drilled shafts are presented in the following chapters. The design of drilled shafts in this manual is presented in the format of load and resistance factor (LRFD) design, consistent with the current (2009) AASHTO standards.

Archived

This page is intentional left blank.



## CHAPTER 2 SITE CHARACTERIZATION

### 2.1 INTRODUCTION

Site characterization is the process of defining the subsurface soil and rock units and their physical and engineering properties. For drilled shafts, the information obtained is used for two general purposes: (1) analysis of resistances and load-deformation response, which determines the overall design, and (2) construction feasibility, costs, and planning. Thorough site characterization makes it possible to design reliable, economical, and constructible drilled shaft foundations that will meet performance expectations. Inadequate site characterization can lead to uneconomical designs, construction disputes and claims, and foundations that fail to meet performance expectations. In the LRFD design approach, uncertainty associated with geomaterial engineering properties is taken into account through resistance factors. Therefore, the site characterization process must be sufficient to define the variability of soil and rock engineering properties used in the LRFD design methods presented in subsequent chapters of this manual.

Table 2-1 summarizes the information needed for design of drilled shafts. For each characteristic or property and for each type of geomaterial, the means or method(s) used to obtain the information are identified. The information required for design of drilled shafts can be divided into three general categories: (1) subsurface stratigraphy and groundwater conditions, (2) index properties and classification of geomaterials, and (3) specific engineering strength and deformation properties. Additional information required specifically for constructability is considered in Section 2.3.4. This chapter describes the general approach to site investigation with a focus on responsibilities of the geotechnical engineer, how to implement a phased investigation program, methods of field exploration and sampling, and preparation of geotechnical reports. Chapter 3 presents a more in-depth description of methods used to determine the specific engineering properties used in the design equations and listed in Table 2-1. In addition, some design equations are based on empirical correlations between foundation resistances and measurements from in-situ tests. These are discussed in the appropriate design chapters on lateral loading (Chapter 12) and axial loading (Chapter 13), and in Appendix B (Special Geomaterials).

Article 10.4 of the AASHTO LRFD Bridge Design Specifications (AASHTO, 2007) has provisions for site investigations and establishing soil and rock properties for foundation design. Additional detailed treatment of specific methods is available from several sources. The U.S. Federal Highway Administration has developed reference documents dealing with basic soil mechanics, site characterization, and evaluation of soil and rock properties for geotechnical applications to transportation facilities. These include Mayne et al. (2001), Sabatini et al. (2002), and Samtani and Nowatzki (2006).

### 2.2 ROLE OF THE GEOTECHNICAL ENGINEER

Implementation of an effective site characterization program requires the direct participation of an experienced geotechnical engineer (or engineering geologist) with a thorough understanding of subsurface investigation techniques, foundation design procedures, and drilled shaft construction technology. As a member of the design team for a bridge or other structure, it is the responsibility of the project geotechnical engineer to direct the collection of existing data, conduct field reconnaissance, initiate the subsurface investigation, and to review its progress. It is also important that the geotechnical engineer be involved at the earliest stages of project development to define geotechnical issues that may impact foundation selection and location, and because geotechnical input is necessary throughout the process, from site selection to completion of foundation construction.

**TABLE 2-1 SUMMARY OF FIELD AND LABORATORY METHODS FOR GEOMATERIAL CHARACTERISTICS USED FOR DRILLED SHAFT DESIGN**

Design Parameter or Information Needed	Subsurface Material		
	Cohesionless Soils	Cohesive Soils	Rock (includes Materials Defined as Cohesive IGM)
<i>Subsurface Stratigraphy</i>	Drilling and sampling; SPT, CPTu, CPT, DMT; geophysical methods	Drilling and sampling; SPT, CPT, CPTu, DMT; geophysical methods	Drilling and sampling; Rock core logging
<i>Groundwater Conditions</i>	Well / Piezometer	Well / Piezometer	Well / Piezometer
<i>Index Properties</i>			
Gradation	Sieve analysis	Sieve analysis Hydrometer analysis	N/A
Atterberg Limits	N/A	Liquid Limit and Plastic Limit tests	N/A
Classification	USCS Group Index	USCS Group Index	Rock type
Moisture Content	Wet and oven-dried weights	Wet and oven-dried weights	Lab
Unit Weight, $\gamma$	SPT, DMT	Weight-volume measurements on USS	Weight-volume measurements on rock core
RQD and GSI	N/A	N/A	Rock core logging and photos
Slake Durability Index, ID	N/A	N/A	Lab slake durability test
<i>Engineering Properties</i>			
Effective stress friction angle, $\phi'$	SPT, CPTu, CPT, DMT	CD or CU-bar triaxial on USS	Correlate to GSI
Undrained shear strength, $s_u$	N/A	CU triaxial on USS; VST, CPT	N/A
Preconsolidation stress, $\sigma'_p$	SPT, CPT	Consolidation test on USS; DMT, CPTu, CPT	N/A
Soil modulus, $E_s$	PMT, DMT, SPT, CPT; correlate w/ index properties	Triaxial test on USS; PMT, DMT; correlate w/ index properties	N/A
Uniaxial compressive strength, $q_u$	N/A	N/A	Lab compression test on rock core
Modulus of intact rock, $E_r$	N/A	N/A	Lab compression test on rock core
Rock mass modulus, $E_m$	N/A	N/A	Correlate to GSI and either $q_u$ or $E_r$ ; PMT

Table Key:

- CD – consolidated drained triaxial compression test
- CPT – Cone Penetration Test (Section 3.1.2)
- CPTu – Cone Penetration Test with pore water pressure measurements (Section 3.1.2)
- CU – consolidated undrained triaxial compression test
- CU-bar – CU test with pore water pressure measurements
- DMT – Dilatometer Test
- GSI – Geological Strength Index
- PMT – Pressuremeter Test; RQD – rock quality designation
- SPT – Standard Penetration Test (Section 3.1.1)
- USS – undisturbed soil sample
- USCS – Unified Soil Classification System
- VST – Vane Shear Test (Section 3.2.2)

Once the data from the field investigation and laboratory testing program have been obtained, the geotechnical engineer is responsible for reduction and interpretation of these data, the definition of subsurface stratification and groundwater conditions, selection of appropriate soil and rock design parameters, and presentation of the investigation findings in a geotechnical report. The design team uses this acquired subsurface information in the analysis and design of drilled shaft foundations, for construction estimates and planning, and if necessary, to evaluate construction claims.

## **2.3 SITE CHARACTERIZATION PROGRAM**

The scope of a site characterization program is determined by the level of complexity of the site geology, foundation loading characteristics, size and structural performance criteria of the bridge or other structure, acceptable levels of risk, experience of the agency, constructability considerations, and other factors. Some of the information needed to establish the scope of site characterization may only be known following a preliminary study of the site. For this reason, site investigations for drilled shaft projects may be carried out through a phased exploration program. This might typically include the following stages: (1) collection of existing site data, (2) a field reconnaissance stage, and (3) a detailed site exploration stage. Further investigation stages can be considered if there are significant design changes or if local subsurface complexities warrant further study. When properly planned, this type of multi-phase investigation provides sufficient and timely subsurface information for each stage of design while limiting the risk and cost of unnecessary explorations. In the overall design process for drilled shafts as presented in Chapter 11 (see Figure 11-1), the collection of existing data and field reconnaissance comprise Step 2: Define Project Geotechnical Site Conditions. The detailed site exploration constitutes Step 4: Develop and Execute Subsurface Exploration and Laboratory Testing Program for Feasible Foundation Systems. Additional site exploration could be required during the construction phase in some cases.

### **2.3.1 Data Collection**

This stage involves collecting all available information pertaining to the site and the proposed structure, as summarized in Table 2-2. The primary source of information concerning the structure will be the Bridge and Structures Office of the state or local transportation agency. Any preliminary plans developed by the structural engineer should be studied and the geotechnical engineer should coordinate directly with the structural engineer and other project staff, preferably through periodic meetings with the design team.

Subsurface information targeted for data collection includes site geology and any existing specific geotechnical information. Site geology refers to the physiography, surficial geology, and bedrock geology of the site. Sources of existing data include: geologic and topographic maps, geologic reports and other publications, computer data bases, aerial photos, borings at nearby sites, previous construction records, and consultation with other geo-professionals. Many references are available that provide detailed information on sources and applications of existing data to geotechnical site characterization (NAVFAC, 1982; Mayne et al., 2001). Table 2-2 identifies sources of existing information and how each source can be used as part of a site study.

The geologic and geotechnical data obtained from the data collection study are used to establish anticipated site conditions and feasibility of various foundation types, make preliminary cost estimates, identify potential problems, and to plan the more detailed phases of site exploration. Following the data collection study, the geotechnical engineer is better prepared for the field reconnaissance stage of the investigation.

**TABLE 2-2 SOURCES AND USE OF PRELIMINARY PROJECT AND SUBSURFACE INFORMATION (MODIFIED AFTER HANNIGAN ET AL., 2006)**

Source	Use
Preliminary structure plans prepared by the bridge design office.	Determine: 1. Type of structure. 2. Preliminary locations of piers and abutments. 3. Foundation loads and special design events. 4. Allowable differential settlement, lateral deformations, and performance criteria. 5. Any special features and requirements.
Construction plans and records for nearby structures.	Foundation types, old boring data, construction information including construction problems.
Topographic maps prepared by the United States Coast and Geodetic Survey (USC and GS), United States Geological Survey (USGS) and State Geology survey.	Existing physical features; landform boundaries and access for exploration equipment. Maps from different dates can be used to determine topographic changes over time.
County agricultural soil survey maps and reports prepared by the United States Department of Agriculture (USDA).	Boundaries of landforms shown; appraisal of general shallow subsurface conditions.
Air photos prepared by the United States Geological Survey (USGS) or others.	Detailed physical relief shown; gives indication of major problems such as old landslide scars, fault scarps, buried meander channels, sinkholes, or scour; provides basis for field reconnaissance.
Well drilling record or water supply bulletins from state geology or water resources department.	Old well records or borings with general soils data shown; estimate required depth of explorations and preliminary cost of foundations.
Geologic publications, maps, and bulletins.	Type and depth of soil deposits; Type, depth, and orientation of rock formations.
Earthquake data, seismic hazard maps, fault maps, and related information available from USGS and earthquake engineering research centers	Earthquake loads, seismic hazards

### 2.3.2 Field Reconnaissance

One or more site visits by the geotechnical engineer, with “plan-in hand” and accompanied by the project design engineer, if possible, is a necessary step in the site characterization process. Site visits provide the best opportunity to observe and record many of the surface features pertaining to access and working conditions and to develop an appreciation of the geologic, topographic, and geotechnical characteristics of the site. Site visits might provide evidence of surface features that will affect construction. A partial listing of factors to be identified includes the following:

- Restrictions on points of entry and positioning of construction equipment and exploratory drilling equipment, such as overhead power lines, existing bridges, and restricted work areas.
- Existence of surface and subsurface utilities and limitations concerning their removal, relocation, or protection.

- Locations of existing structures on the site and on adjacent sites. Descriptions of the as-built foundations of those structures must be obtained if it can be reasonably expected that subsurface ground movements could occur at the locations of those foundations due to drilled shaft construction.
- Locations of trees and other vegetation, and limitations concerning their removal or damage.
- Possibility of subsurface contamination, *e.g.*, due to abandoned underground petroleum tanks or old landfills.
- Presence of surface water.
- Fault escarpments, boulders, hummocky ground, and other surface features that may suggest subsurface conditions.
- Comparisons of initial and final surface contours of the site.
- Condition of the ground surface that might be reasonably expected at the time of construction as related to trafficability of construction equipment.
- Restrictions on noise and/or other environmental conditions.

Ground geologic surveys may also be conducted as part of a reconnaissance study at sites where geologic hazards exist (*e.g.*, landslides) or where surface outcrops can provide beneficial information. In these surveys, engineering geologists record observations on topography, landforms, soil and rock conditions, and groundwater conditions. Where bedrock is exposed in surface outcrops or excavations, field mapping can be an essential step to obtaining information about rock mass characteristics relevant to design and construction of rock-socketed shafts. A qualified engineering geologist or geotechnical engineer can make and record observations and measurements on rock exposures that may complement the information obtained from borings and core sampling. Rock type, hardness, composition, degree of weathering, orientation and characteristics of discontinuities, and other features of a rock mass may be readily assessed in outcrops or road cuts. Guidance on detailed geologic mapping of rock for engineering purposes is given in FHWA (1989), Murphy (1985), and ASTM D 4879 (ASTM, 2000). Photography of the rock mass can aid engineers and contractors in evaluating rock mass characteristics or potential problems associated with a particular rock unit.

After completing the data collection study and site reconnaissance, the geotechnical engineer should be able to identify the overall foundation design and construction requirements of the project. Feasible foundation types should be determined at this stage and it is assumed in the remainder of this chapter that drilled shafts have been selected for further investigation. The types of geotechnical data needed and potential methods available to obtain the needed data are identified and used to plan the subsequent phases of the investigation.

### **2.3.3 Detailed Field Investigations**

This stage provides the site-specific information needed for design and construction of drilled shafts. Methods include geophysical surveys, drilling and sampling, field testing, and laboratory testing. In-situ and laboratory testing for determination of soil and rock engineering properties are covered in greater detail in Chapter 3. For major structures it is common practice to divide the field exploration into two phases. Initially, borings performed at a few select locations and geophysical tests are used to establish a preliminary subsurface profile and thus identify key soil and rock strata. Following analysis of the preliminary boring data, additional borings are then performed to fill in the gaps required for design and

construction. A staged investigation program provides sufficient information for preliminary design, but defers much of the cost for the site investigation until the structure layout is finalized.

It is assumed that the project structural engineer has developed a preliminary plan prior to this stage in the investigation. The geotechnical engineer uses the preliminary plan for the bridge or other structure to establish the locations of geophysical surveys and locations, depths, type, and number of borings to be performed. In cases where the investigation is being done for a building, the designers should provide the layout and footprint of the building, plans, and any column and wall loads. Retaining wall or slope stabilization projects require preliminary plans showing the location of drilled shaft walls in plan view and cross-section including elevations.

### 2.3.3.1 Geophysical Surveys

Geophysical methods, in conjunction with borings, can provide useful information about the stratigraphy and properties of subsurface materials. Basic descriptions of geophysical methods and their application to geotechnical engineering are given by Sirles (2006) and FHWA (2008a).

The most frequently applied geophysical methods for drilled shaft foundation sites are seismic refraction and electrical resistivity. Seismic refraction is based on measuring the travel time of compressional waves through the subsurface. Upon striking a boundary between two media of different properties the propagation velocity is changed (refraction). This change in velocity is used to deduce the subsurface profile. Figure 2-1(a) illustrates the basic idea for a simple two-layer profile in which soil of lower seismic velocity ( $V_{p1}$ ) overlies rock of higher seismic velocity ( $V_{p2}$ ). A plot of distance from the source versus travel time (Figure 2-1b) exhibits a clear change in slope corresponding to the depth of the interface ( $z_c$ ). Solutions are also available for the cases of sloping interfaces and multiple subsurface layers. The equipment consists of a shock wave source (typically a hammer striking a steel plate), a series of geophones to measure seismic wave arrival, and a seismograph with oscilloscope. The seismograph records the impact and geophone signals in a timed sequence and stores the data digitally. The technique is rapid, accurate, and relatively economical when applied correctly. The interpretation theory is relatively straightforward and equipment is readily available. The most significant limitations are that it is incapable of detecting material of lower velocity (lower density) underlying higher velocity (higher density) and that thin layers sometimes are not detectable (Mayne et al., 2001). For these reasons, it is important not to rely exclusively on seismic refraction, but to verify subsurface stratigraphy in several borings and correlate the seismic refraction signals to the boring results. One of the most effective applications of seismic refraction is to provide depth to bedrock over a large area, eliminating some of the uncertainty associated with interpolations of bedrock depths for locations between borings.

A recently developed method based on enhanced seismic refraction shows promise for characterizing sites requiring depth to bedrock information and for differentiating subsurface boundaries between soft or loose soils and stiff or dense soils. The method is based on measurements of seismic refraction microtremor data (commonly referred to as the ReMi method). The ReMi method uses the same instrumentation and field layout as a standard refraction survey. However, there are no predefined source points or any need for timed or 'triggered' seismic shots. Instead, the ReMi method uses ambient noise, or vibrational energy that exists at a site without the use of input energy from hammers or explosives. Ambient energy can be anything from foot traffic to vehicles, construction activities, tidal energy, and microtremor earthquakes. Additionally, an off-line, high amplitude energy source can be used to augment ambient energy.

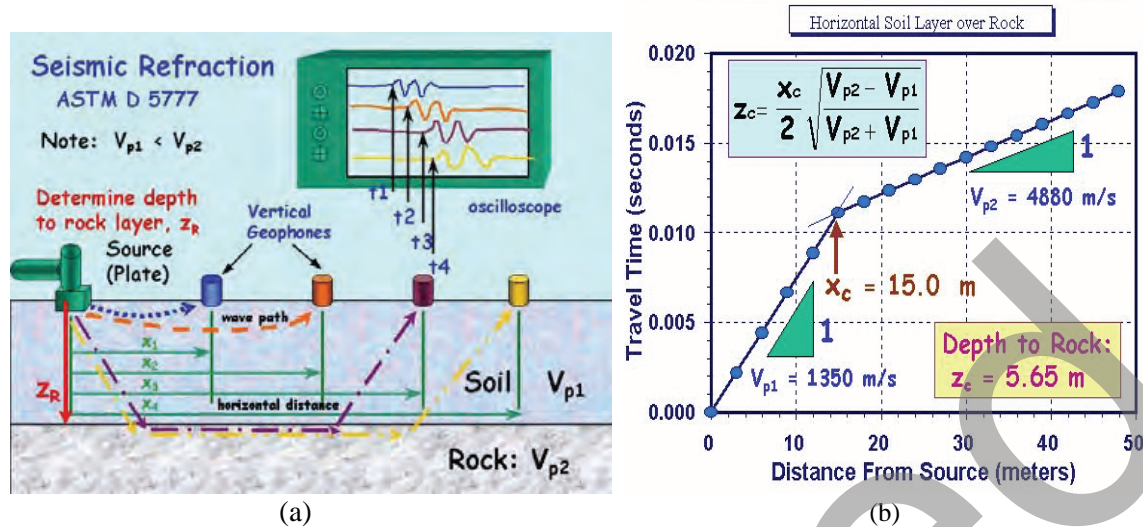


Figure 2-1 Seismic Refraction Method (Mayne et al., 2001); (a) Field Setup and Procedures; (b) Data Reduction for Depth to Hard Layer (1 m = 3.28 ft)

The analysis method is a surface-wave technique that relates the Rayleigh-wave velocity to shear-wave velocity through an empirical relationship (Louis, 2001). It is based on two fundamental concepts. First, that the seismic recording equipment can effectively record surface waves at frequencies as low as 2 Hz, which requires the use of low frequency geophones. Second, a simple, two-dimensional slowness-frequency (p-f) transform of a microtremor record can separate Rayleigh surface waves from other seismic arrivals. This separation allows recognition of the shear wave velocities of subsurface materials. Advantages of ReMi are that it: requires only standard refraction instrumentation; requires no triggered source of wave energy; and, it is effective in seismically noisy urban settings.

The two-dimensional ReMi method has been used to image the soil/bedrock interface beneath rivers (i.e., saturated soil conditions where standard P-wave methods do not work) and in urban settings where noisy site conditions prohibit use of conventional refraction or reflection methods (Sirles et al., 2009). A recent application of ReMi to a transportation project involving drilled shafts in Honolulu, HI, illustrates its usefulness. As described by Sirles et al. (2009) approximately 2.7 miles of ReMi profiles were obtained in order to determine depth to bedrock and to characterize lateral variability of soil deposits as part of the Honolulu High-Capacity Transit Corridor Project (HHCTCP). Bedrock (basalt) within the project area exhibits extreme topographic variations and can range from depths of 5 ft below the surface to over 230 ft below the surface, with changes occurring over short distances. ReMi was selected for its ability to establish depth to bedrock between borings, resulting in significant cost savings by reducing the number of borings required otherwise. Figure 2-2 shows a typical subsurface profile from ReMi measurements. Using correlations from borings and sampling, it was established that the 600 ft/sec velocity contour represents a boundary between undifferentiated soft/loose soils and stiff/dense soils, while the 2,000 ft/sec contour represents the approximate boundary between overlying soils and sound rock (basalt).

Resistivity is a fundamental electrical property of geomaterials that varies with material type and water content. To measure resistivity from the ground surface (Figure 2-3), electrical current is induced through two current electrodes ( $C_1$  and  $C_2$ ) while change in voltage is measured by two potential electrodes ( $P_1$  and  $P_2$ ). Apparent electrical resistivity is then calculated as a function of the measured voltage difference, the induced current, and spacing between electrodes. Two techniques are used. In a sounding survey the

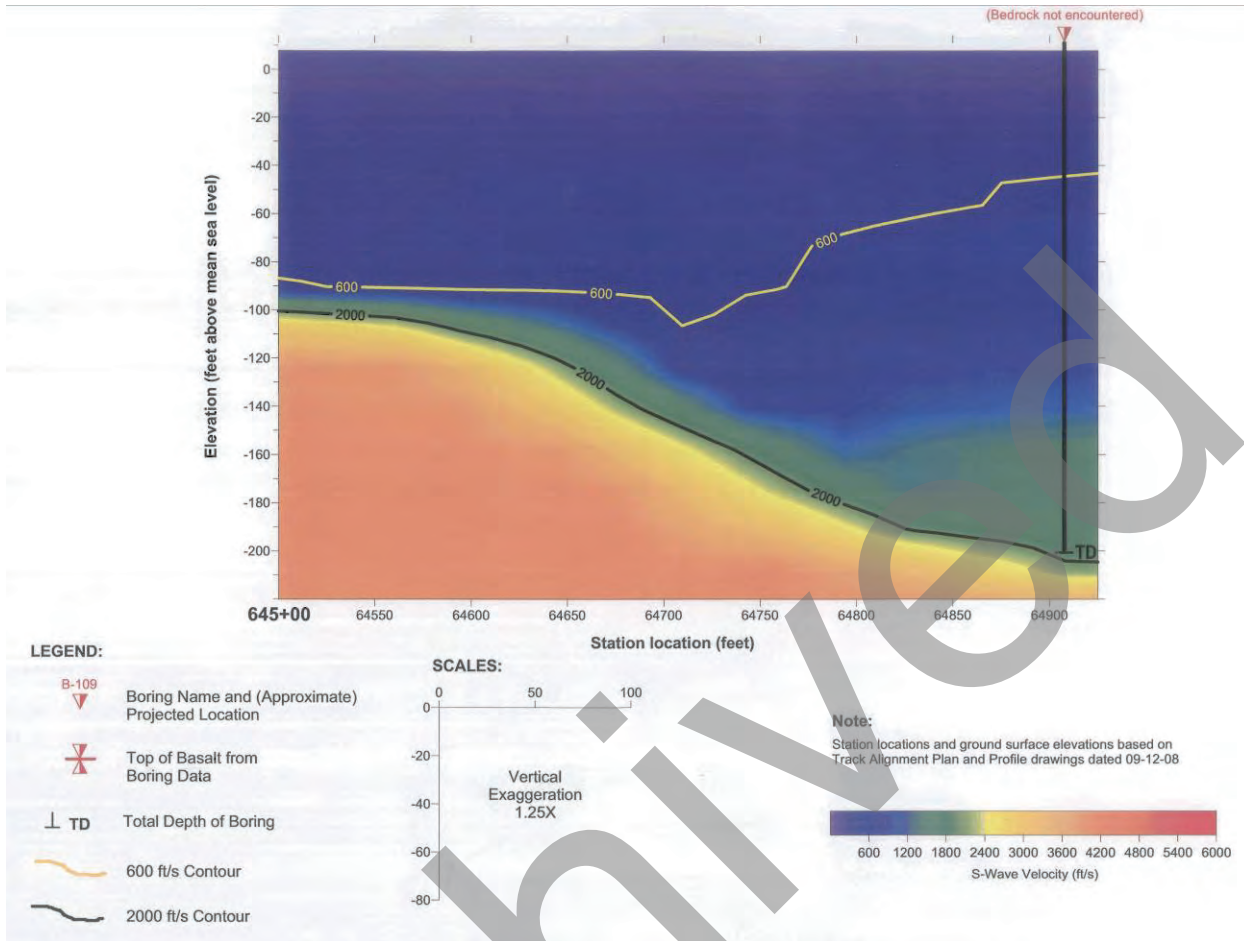


Figure 2-2 ReMi Seismic Velocity Profile (Zonge Geosciences, Inc., 2009)

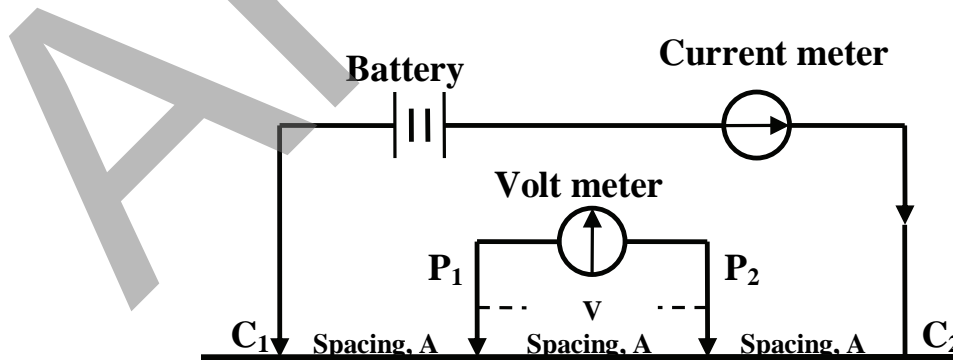


Figure 2-3 Field Configuration for Resistivity Test



centerline of the electrodes is fixed while the spacing of the electrodes is increased for successive measurements. The depth of material subjected to current increases with increasing electrode spacing. Therefore, changes in measured apparent resistivity with increasing electrode spacing are indicative of a change in material at depth. In this way variations in material properties with depth (layering) can be determined. The second method is a profiling survey, in which the electrode spacing is fixed but the electrode group is moved horizontally along a line (profile) between measurements. Changes in measured apparent resistivity are used to deduce lateral variations in material type. Electrical resistivity methods are inexpensive and best used to complement seismic refraction surveys and borings. The technique has advantages for identifying soft materials between borings. Limitations are that lateral changes in apparent resistivity can be interpreted incorrectly as depth related. For this and other reasons, depth determinations can be in error, which is why it is important to use resistivity surveys in conjunction with other methods.

Multi-electrode resistivity arrays can provide detailed subsurface profiles in karst terranes, one of the most difficult geologic environments for drilled shaft foundations. Two-dimensional profiling using multi-electrode arrays produce reasonable resolution for imaging features such as pinnacled bedrock surfaces, overhanging rock ledges, fracture zones, and voids within the rock mass and in the soil overburden. Figure 2-4 shows a resistivity tomogram at a bridge site on I-99 in Pennsylvania. The site is located in karst underlain by dolomite and limestone. The resistivity profile provided a very good match to the stratigraphy observed in borings, particularly for top of rock profile. In the tomogram the top-of-rock profile is well defined by the dark layer. Inclusions of rock in the overlying soil are also clearly defined. This technology should be considered for any site where an estimate of the rock surface profile is required and would provide valuable information for both design and construction of rock socketed foundations.

Ground penetrating radar (GPR) is a non-invasive surface technique that is useful for imaging the generalized subsurface conditions and detecting utilities, hidden objects, and other anomalies to depths of approximately 20 to 30 ft. GPR could be used to greater benefit than is currently the case for locating drilling obstructions such as old footings, buried concrete debris, and boulders. Identifying buried objects prior to construction can save costs and reduce claims because they can be removed using a backhoe or other excavating equipment prior to drilled shaft construction, or plans can be made to work around the object. If discovered during drilled shaft excavation these objects are considered obstructions and their removal is more costly and time-consuming.

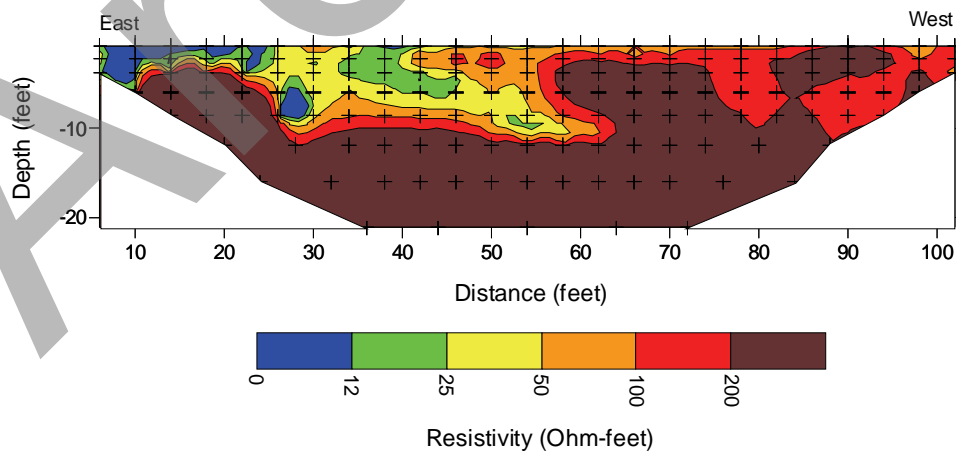


Figure 2-4 Resistivity Tomogram, Pennsylvania Bridge Site in Karst (Hiltunen and Roth, 2004)

Other geophysical methods have potential applications to geotechnical exploration at sites where drilled shaft foundations will be used, but are not in common use at this time. These include downhole and crosshole seismic methods. Downhole seismic is based on measuring arrival times in boreholes of seismic waves generated at the ground surface. Crosshole seismic involves measuring travel times of seismic waves between boreholes. Both methods provide subsurface stratigraphy, depth to rock, p-wave and s-wave velocities, dynamic shear modulus, small-strain Young's modulus, and Poisson's ratio. These parameters typically are applicable to analysis of site and structure response to earthquake motion. Crosshole tomography is based on computer analysis of crosshole seismic or resistivity data to produce a 3-dimensional representation of subsurface conditions. These techniques are more expensive and require specialized expertise for data interpretation, but may be warranted for large structures where the detailed information enables a more cost-effective design or eliminates uncertainty that may otherwise lead to construction cost overruns. Spectral analysis of surface waves (SASW) is capable of determining subsurface layering and small-strain properties of soil and rock.

Each geophysical method has limitations associated with the underlying physics, with the equipment, and the individuals running the test and providing interpretation of the data. The reader is referred to the study by Sirles (2006) for discussion of limitations.

### 2.3.3.2 Depth, Spacing, and Frequency of Borings

AASHTO (2007) recommends a minimum of one boring per substructure (pier or abutment) at bridge sites where the width of the substructure is 100 ft or less and at least two borings at substructures over 100 ft wide. These recommendations are the minimum for foundations in general, and drilled shafts may require additional borings. Table 2-3 presents general guidelines on the number of borings to be made per drilled shaft foundation location. These recommendations should also be considered minimums. If possible, it is desirable to locate a boring at every drilled shaft. In practice this is not always feasible and factors such as experience, site access, degree of subsurface variability, geology, and importance of the structure will be considered. Where subsurface conditions exhibit extreme variations over short distances, multiple borings may be justified at a single shaft location to determine adequately the soil or rock conditions along the side and beneath the tip. For example, large-diameter shafts in karstic limestone, whether single or in groups, may require multiple borings at each shaft location to verify that the entire base will be founded on limestone and will not be affected by voids or zones of soil beneath the base. The recommendation in Table 2-3 to invest in one boring per shaft for rock-socketed shafts is based on the philosophy that the cost of borings, while significant, reduces the uncertainties and risk inherent in the design and construction of rock sockets by providing site-specific information on depth to rock, condition of the rock beneath the base, water inflow, and the type of drilling tools needed to penetrate the rock.

**TABLE 2-3 RECOMMENDED MINIMUM FREQUENCY OF BORINGS, DRILLED SHAFT FOUNDATIONS FOR BRIDGES**

Redundancy Condition	Shaft Diameter (ft)	Guideline
Single-column, single shaft foundations	All	One boring per shaft
Multiple-shaft foundations in soil	≥ 6 ft	One boring per shaft
	< 6 ft	One boring per 4 shafts
Multiple-shaft foundations in rock	All	One boring per shaft

For drilled shaft retaining walls, a minimum of one boring is required for walls up to 100 ft long. For walls more than 100 ft length, the spacing between borings should be no greater than 200 ft. Additional borings inboard and outboard of the wall line to define conditions at the toe of the wall and in the zone behind the wall to estimate lateral loads and anchorage capacities should be considered. The same considerations identified above for bridge foundations and pertaining to highly variable sites and classification of materials for payment purposes also apply to drilled shafts for retaining walls.

AASHTO (2007) recommends the following for depth of borings, for both bridge foundations and retaining walls:

'In soil, depth of exploration should extend below the anticipated pile or shaft tip elevation a minimum of 20 ft, or a minimum of two times the maximum pile group dimension, whichever is deeper. All borings should extend through unsuitable strata such as unconsolidated fill, peat, highly organic materials, soft, fine-grained soils, and loose coarse grained soils to reach hard or dense materials'

'For shafts supported on or extending into rock, a minimum of 10 ft of rock core, or a length of rock core equal to at least three times the shaft diameter for isolated shafts or two times the maximum shaft group dimension, whichever is greater, shall be extended below the anticipated shaft tip elevation to determine the physical characteristics of rock within the zone of foundation influence. Note that for highly variable bedrock conditions, or in areas where very large boulders are likely, more than 10 ft. of rock core may be required to verify that adequate quality bedrock is present.'

The above recommendations for borings in soil and rock to be made to two times the maximum group dimension may not be practical or necessary in many cases. For example, if a group of shafts is designed so that tip elevations correspond to the top of rock and the rock mass is known to be competent material, there is no need to extend borings beyond three shaft diameters into the rock. In rock, geologic knowledge based on experience should always take precedence over general guidelines such as those given above. In rock mass that is known to be uniform and free of cavities, voids, weathered zones, etc., it may not be necessary to drill more than one diameter below the tip elevation. On the other hand, in highly variable rock mass containing solution cavities, weak zones, boulders in a soil matrix, or other potentially adverse features, borings may need to extend as deep as necessary to verify competent bearing layers. All of the recommendations cited above, for both frequency and depth of borings, are always subject to modification based on the level of geologic knowledge of the site and subsurface variability. In general, the more uniform the subsurface conditions and the more experience the geotechnical engineer has with those conditions, the less number of borings. For sites with highly varying geologic conditions and where there is little prior experience, more and deeper borings may be warranted.

It is also common practice to include in construction contracts requirements for borings to be made at specific shaft locations. In such cases, the final shaft depth is established during construction on the basis of information obtained from these borings, as well as from drilled shaft load tests.

### **2.3.3.3 Boring Methods**

Subsurface borings provide detailed information on stratigraphy and are used to obtain samples of soil and rock from which the index and engineering properties given in Table 2-1 are determined. Borings also provide the means for conducting in-situ tests, groundwater observations, and installation of instrumentation. Equipment and procedures for conducting borings and sampling are described in detail in Mayne et al. (2001). The treatment here omits specific details and provides a general outline of methods, equipment, and procedures.

Table 2-4 is a summary of the most common methods to advance borings in soil and rock. The method selected should be compatible with the soil and groundwater conditions to assure that samples of suitable quality are obtained. Hollow stem augers are used frequently for exploratory borings in soil because they serve to advance the hole, carry cuttings to the surface, and provide access through which sampling and testing devices can be lowered and operated. However, hollow stem augers should be avoided in granular soils below the groundwater table due to the risk of disturbing the soils to be sampled below the auger. Rotary drilling should be used in these cases.

Sonic coring methods are based on transmitting vertical vibrations from a drill head through the drill string, typically at a frequency of 50 to 180 Hertz (hence the term sonic). A thin layer of soil around the drill string is fluidized, reducing friction between the sampling barrel and the surrounding soil and allowing rapid penetration. The reduced friction also occurs along the inner surface of the sampling tool, enabling long core samples to be obtained (up to 15 ft) and providing the option of continuous sampling. Most sonic drill rigs employ a rotary mechanism that can be used in combination with sonic vibration. This feature makes it possible to drill through rock, concrete, and asphalt.

#### 2.3.3.4 Sampling of Soil

Samples of soil and rock are retrieved from specific depths of a boring using various sampling devices. The samples are used for visual examination and for determination of the index and engineering properties listed in Table 2-1.

Sampling devices can be distinguished on the basis of whether the sample is disturbed or relatively undisturbed. Disturbed samples are altered by the sampling method such that they are not suitable for measurement of engineering properties such as strength and compressibility. However, disturbed samples are suitable for visual description, index tests, and soil classification. The term undisturbed refers to samples recovered using methods that maintain the integrity of the soil structure and fabric. It is then assumed that laboratory tests used to measure soil engineering properties are representative of in-situ soil properties. Table 2-5 is a summary of the most common sampling methods used in U.S. practice.

The split-barrel sampler is the most widely-used sampling device. This sampler is used in all types of soils and the sample is disturbed (Figure 2-5a). One of the most widely used split-barrel samplers is the *standard split spoon*, having an outer diameter of 2 inches and an inside diameter of 1-3/8 inch. The standard split spoon is used in conjunction with the Standard Penetration Test (SPT) in which a 140-lb hammer dropped from a height of 30 inches is used to drive the sampler over a depth of 18 inches, as specified in AASHTO T206 and ASTM D1586. In addition to a sample, the SPT also provides the field N-value, or number of blows required to drive the standard split spoon sampler over the second and third 6-inch increments. The SPT and its role in characterizing soil properties are described further in Section 3.1 (in-situ tests). Split-barrel samplers are also available in diameters larger than the standard split spoon, typically with inside diameters ranging from 1.5 inches to 4.5 inches and in standard lengths of 18 inches and 24 inches; however, blow counts obtained with split-barrel samplers other than the standard split spoon are not valid for determination of SPT N-values.

Split-barrel samplers can also be provided with a liner consisting of a thin metal or plastic tube fitted inside the barrel. The liner helps to hold the sample together during handling and may be a continuous tube or a series of rings 1 to 4 inches in length and stacked inside the barrel. Disturbed samples obtained with split barrels are suitable for soil identification, stratigraphy, and general classification tests. Split-barrel samples should be taken at 5-ft intervals and at significant changes in soil strata. Jar or bag samples should be sent to a lab for classification testing and verification of field visual soil identification.

**TABLE 2-4 METHODS OF BORING AND SAMPLING (MODIFIED AFTER HANNIGAN ET AL., 2006)**

<b>Method</b>	<b>Depth</b>	<b>Type of Samples Taken</b>	<b>Advantages</b>	<b>Disadvantages</b>	<b>Remarks</b>
Wash Boring	Most equipment can drill to depths of 100 ft or more.	Disturbed and undisturbed.	<ol style="list-style-type: none"> <li>Borings of small and large diameter.</li> <li>Equipment is relatively inexpensive.</li> <li>Equipment is light.</li> <li>Wash water provides an indication of change in materials.</li> <li>Method does not interfere with permeability tests.</li> </ol>	<ol style="list-style-type: none"> <li>Slow rate of progress.</li> <li>Not suitable for materials containing stones and boulders.</li> <li>Potential for loss of fines in samples</li> </ol>	Hole advanced by a combination of the chopping action of a light bit and jetting action of the water coming through the bit.
Rotary Drilling in Soil	Most equipment can drill to depths of 200 ft or more.	Disturbed and undisturbed.	<ol style="list-style-type: none"> <li>Suited for borings 4 to 6 inches in diameter.</li> <li>Most rapid method in most soils and rock.</li> <li>Relatively uniform hole with little disturbance to the soil below the bottom of hole.</li> <li>Experienced driller can detect changes based on rate of progress.</li> </ol>	<ol style="list-style-type: none"> <li>Drilling mud, if used, does not provide an indication of material change as the wash water does.</li> <li>Use of drilling mud hampers the performance of permeability tests and identification of groundwater table.</li> </ol>	Hole advanced by rapid rotation of drilling bit and removal of material by water or drilling mud. Rock coring is performed by rotary drilling.
Sonic coring	Up to 1,000 ft.	Disturbed	<ol style="list-style-type: none"> <li>Facilitates sampling of soils with large particles (gravel, cobbles, boulders) which may be difficult using other methods</li> <li>Rapid penetration in cohesionless soils</li> <li>Allows continuous sampling</li> <li>Can minimize or eliminate need for drilling fluid</li> </ol>	<ol style="list-style-type: none"> <li>Advancing the sampler can be difficult in stiff/hard clayey soils</li> <li>Requires specialized equipment and knowledge</li> </ol>	Can be combined with rotary drilling to minimize sample disturbance and for drilling through concrete, rock, and asphalt
Auger Borings	Most equipment can drill to depths of 100 to 200 ft.	Disturbed and undisturbed.	<ol style="list-style-type: none"> <li>Boring advanced without water or drilling mud.</li> <li>Hollow stem auger acts as a casing and provides a means to conduct Standard Penetration Test (SPT)</li> </ol>	<ol style="list-style-type: none"> <li>Difficult to detect change in material.</li> <li>Heavy equipment required.</li> <li>Water level must be maintained in boring equal to or greater than existing water table to prevent sample disturbance (may be difficult to achieve consistently).</li> </ol>	Hole advanced by rotating and simultaneously pressing an auger into the ground either mechanically or hydraulically.
Rotary Drilling in Rock	Most equipment can drill to depths of 200 ft or more.	Continuous rock cores.	<ol style="list-style-type: none"> <li>Helps differentiate between boulders and bedrock.</li> <li>Provides access for borehole televiewers</li> </ol>	Can be slow and fairly expensive	Several types of core barrels are used including wire line core barrels for deep drilling.

**TABLE 2-5 COMMON SAMPLING METHODS IN SOIL (after Mayne et al., 2001)**

Sampler or Sample Type	Disturbed / Undisturbed	Appropriate Soil Types	Method of Penetration	% Use in Practice
Split-Barrel (Split Spoon)	Disturbed	Sands, Silts, Clays	Hammer driven	85
Thin-Walled Shelby Tube	Undisturbed	Clays, Silts, fine-grained soils, clayey Sands	Mechanically pushed	6
Continuous Push	Partially Undisturbed	Sands, Silts, and Clays	Hydraulic push with plastic lining	4
Piston	Undisturbed	Silts and Clays	Hydraulic Push	1
Pitcher	Undisturbed	Stiff to hard Clay, Silt, Sand, partially weathered rock; frozen or resin impregnated granular soil	Rotation and hydraulic pressure	<1
Denison	Undisturbed	Stiff to hard Clay, Silt, Sand and partially weathered rock	Rotation and hydraulic pressure	<1
Modified California	Disturbed	Sands, Silts, Clays, and Gravels	Hammer driven (large split barrel)	<1
Continuous Auger	Disturbed	Cohesive soils	Drilling w/ Hollow Stem Augers	<1
Bulk	Disturbed	Gravels, Sands, Silts, Clays	Hand tools, bucket augering	<1



(a)



(b)

Figure 2-5 Common Sampling Devices for Soil (Mayne, et. al., 2001); (a) Split-Barrel Sampler; and (b) Various Diameter Shelby Tubes

Relatively undisturbed samples of fine-grained soils suitable for laboratory testing of strength and compressibility properties can be retrieved using a variety of thin-walled samplers that are pushed into the soil. Details on sampling are described in AASHTO T207 or ASTM D-1587. The simplest and most widely used version is the Shelby tube, as shown in Figure 2-5b. Thin wall open tube samplers are best suited for sampling soft to medium stiff cohesive soils. Sample recovery and/or sample disturbance may be unacceptable in very soft soils. It is also difficult to sample very hard or gravelly soils using thin-wall tube samplers. To overcome these shortcomings several variations have been developed. Fixed piston samplers are particularly useful for sampling soft soils where sample recovery is difficult, and can also be used in stiff clays and silts. Piston samplers are basically thin wall tube samplers with a piston, rod, and a modified sampler head. The piston allows suction to be applied to the top of the sample, helping to prevent sample loss and minimizing disturbance. For hard and stiff soils and soft rock, Pitcher and Denison samplers can be used to obtain relatively undisturbed samples. These samplers are rotated and pushed into the subsurface, much like coring in rock. Thin wall tube samples of fine-grained soils should be taken at 5-ft intervals and at significant changes in strata. Tube samples can be alternated with split-spoon samples in the same boring or taken in separate borings.

Each sampling method has advantages and limitations that depend upon the type and condition of soil being sampled. In addition, there are details in the operation, sampling procedure, and sample handling that are important and unique to each method. A full treatment of each sampling method outlined in Table 2-5 is beyond the scope of this manual. However, the geotechnical engineer involved in site characterization for a drilled shaft project must be familiar with sampling technologies in order to make appropriate judgments when selecting soil properties based on testing of samples obtained by the various methods. Applicable AASHTO and ASTM standards and Mayne et al. (2001) are recommended for further reading.

Soils should be identified and classified in the field by a qualified geotechnical engineer or geologist and the results presented in the form of a field boring log. A standardized procedure for field identification of soils is given by ASTM D 2488 based on methods developed by Burmister (1970). This approach involves simple and rapid visual-manual procedures to categorize soils on the basis of particle size and gradation and overall plasticity index. The final boring logs for inclusion in the geotechnical report may be modified to incorporate the results of more definitive laboratory classifications tests (Chapter 3), but the original field boring logs are an important and essential record of site conditions at the time of drilling and sampling.

### **2.3.3.5 Rock Coring and Core Logging**

Rock core drilling is accomplished using rotary drill equipment. A hollow coring tube equipped with a diamond or tungsten-carbide cutting bit is rotated and forced downward to form an annular ring while preserving a central rock core. Standard core barrel lengths are 5 ft and 10 ft. Fluid, either water or drilling mud, is circulated for cooling at the cutting interface and removal of cuttings. Selecting the proper tools and equipment to match the conditions and the expertise of an experienced drill crew are essential elements of a successful core drilling operation. Once rock is encountered, coring normally is continuous to the bottom of the hole. Where the rock being sampled is deep, wireline drilling in which the core barrel is retrieved through the drill stem eliminates the need to remove and reinsert the entire drill stem and can save considerable time. If sampling is not continuous, drilling between core samples can be accomplished using solid bits.

Rock coring bits and barrels are available in standardized sizes and notations. Important considerations in core barrel selection are (1) core recovery, and (2) ability to determine the orientation of rock mass structural features relative to the core. Core recovery (length of rock core actually recovered from a core run) is most important in highly fractured and weak rock layers, because these zones typically are critical for evaluation of foundation load transfer. For sampling of competent rock, bits and core barrels that provide a minimum of 2-inch diameter (nominal) core are adequate for providing samples used for index tests, rock quality designation (RQD), laboratory specimens for strength testing, and for evaluating the conditions of discontinuities. For example, NWM (formerly NX) diamond bit and rock core equipment drills a 3 inch diameter hole and provides a 2.125 inch diameter rock core. When weak, soft, or highly fractured rock is present, it may be necessary to use larger diameter bits and core barrels in order to improve core recovery and to obtain samples from which laboratory strength specimens can be prepared. Coring tools up to 6-inch outer diameter are used. A recommended practice for best core recovery is to use triple-tube core barrels, in which the inner sampling tube does not rotate during drilling and is removed by pushing instead of hammering, features that minimize disturbance. Descriptions of coring equipment and techniques are given in Acker (1974), AASHTO (1988), and USACE (2001).

During core drilling the rate of downward advancement should be monitored and recorded on the boring log in units of minutes per foot. Only time spent advancing the boring should be used to determine the drilling rate. Cores should be photographed immediately upon removal from the borehole (Figure 2-6a). A label should be included in the photograph to identify the borehole, the depth interval, and the number of the core runs. It may be desirable to get a "close-up" of core features relevant to drilled shaft behavior or construction, such as highly weathered or highly fractured zones. Wetting the surface of the recovered core using a spray bottle and/or sponge prior to photographing will often enhance the color contrasts of the core. A tape measure or ruler should be placed across the top or bottom edge of the box to provide a scale in the photograph. The tape or ruler should be at least 3 ft long, and it should have relatively large, high contrast markings to be visible in the photograph.

Rock cores should be stored in structurally sound boxes specifically intended for core of the recovered diameter (Figure 2-6b). Cores should be handled carefully during transfer from barrel to box to preserve mating across fractures and fracture-filling materials. Breaks that occur during or after the core is transferred to the box should be refitted and marked with three short parallel lines across the fracture trace to indicate a mechanical break. Breaks made to fit the core into the box and breaks made to examine an inner core surface should be marked as such. These deliberate breaks should be avoided unless absolutely necessary. Further discussion of sample preservation and transportation is presented in ASTM D 5079.

A widely used index of rock quality is the RQD (rock quality designation, ASTM D6032), illustrated in Figure 2-7. A general description of rock mass quality based on RQD is given in Table 2-6. Its wide use and ease of measurement make it an important piece of information to be gathered on all core holes. Taken alone, RQD should be considered only as an approximate measure of overall rock quality. RQD is most useful when combined with other parameters that account for rock strength, deformability, and discontinuity characteristics. In this manual, RQD is used to estimate a side resistance reduction factor for shafts in fractured rock (Chapter 13). RQD is also a useful index for selecting preliminary tip elevations of drilled shafts on the basis of overall rock quality.

RQD is equal to the sum of the lengths of sound pieces of core recovered, 4 inches or greater in length, expressed as a percentage of the length of the core run (Deere and Deere 1989). Figure 2-7 illustrates the recommended procedure. Several factors must be evaluated properly for RQD to provide reliable results. RQD was originally recommended for NX size core, but experience has shown that the somewhat smaller NQ wireline sizes, larger wireline sizes, and other core sizes up to 6 inches are appropriate (Deere and Deere 1989). RQD based on the smaller BQ and BX cores or with single-tube core barrels is discouraged because of core breakage. Core segment lengths should be measured along the centerline or axis of the



core, as shown in Figure 2-7. Only natural fractures such as joints or shear planes should be considered when calculating RQD. Core breaks caused by drilling or handling should be fitted together and the pieces counted as intact lengths. Drilling breaks can sometimes be distinguished by fresh surfaces.



Figure 2-6 Field Photography of (a) Rock Core in the Sampler; and (b) Rock Core Stored in Boxes

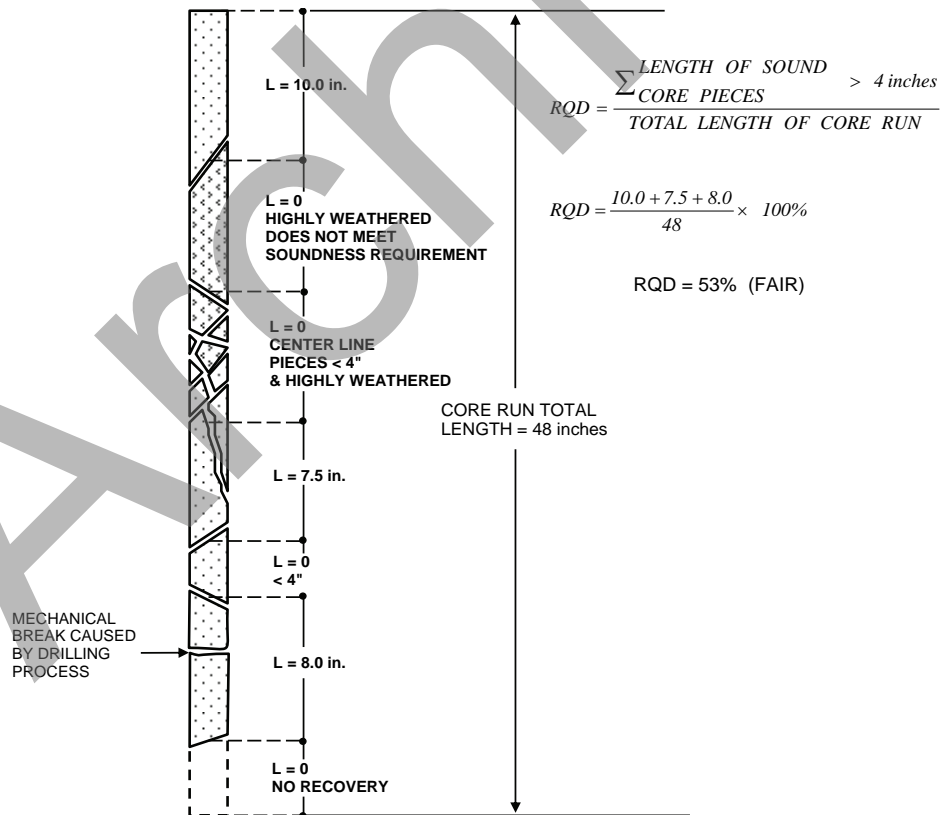


Figure 2-7 RQD Determination from Rock Core (after Deere and Deere, 1989)

**TABLE 2-6 ROCK QUALITY BASED ON RQD**

<i>Rock Mass Description</i>	<i>RQD</i>
Excellent	90 - 100
Good	75 - 90
Fair	50 - 75
Poor	25 - 50
Very Poor	< 25

Problems with core breakage and loss are most prevalent in thinly bedded and schistose rocks, especially weak argillaceous rock interbedded with harder sandstone or limestone. The problem is best addressed by large diameter cores, shorter coring runs, and by use of the best drilling equipment and techniques. Where it is not possible to distinguish natural fractures from those caused by drilling, it is conservative to not count the length near horizontal breaks. RQD should be determined as soon as possible after the core is retrieved to avoid the effects of disturbance due to handling or deterioration due to exposure, which may include slaking and separation of core along bedding planes (“discing”), especially in moisture-sensitive rocks like some shales. Promptness is also desirable because RQD is a quantitative measure of core quality at the time of drilling when the rock core is “fresh” and most representative of in-situ conditions.

Rock assigned a weathering classification of “highly weathered” should not be counted as sound core in the determination of RQD. This is referred to as the soundness requirement and is illustrated by the second and third intervals from the top in Figure 2-7. RQD measurements assume that core recovery is at or near 100 percent. As core recovery varies from 100 percent, explanatory notes may be required to describe the reason for the variation and the effect on RQD.

AASHTO (2007), Articles 10.4.6.4 and 10.6.4.5, provides information on rock strength and deformation properties needed for foundation design. The strength and deformation properties of rock mass are determined by correlation to the rock mass rating (RMR) based on a set of parameters obtained from visual and physical examination of rock core. In recent years a new rock mass index referred to as Geological Strength Index (GSI) has superseded RMR as a tool for correlation with rock mass strength and deformation properties (Hoek and Marinos, 2007) and correlations to GSI are recommended for foundation design (Turner, 2006). A description of GSI and its relationship to rock mass engineering properties needed for drilled shaft design is presented in Chapter 3. However, the procedures for describing rock during field mapping or rock core logging are part of the field investigation and are described in this chapter. This basic information is needed to characterize the rock mass regardless of the system used for classification (RMR or GSI). In addition, the descriptive information presented below will be used by contractors to assess constructability and costs of drilled shaft construction.

The International Society of Rock Mechanics (ISRM, 1981) proposed a standardized method for descriptions of rock masses from mapping and core logging. A summary of the ISRM method as given by Wyllie (1999) describes the rock mass in terms of five categories of properties, as presented in Table 2-7. Each of the 13 parameters listed in the table (*a* through *m*) is assigned a description using standardized terminology. Figures 2-8 and 2-9 show an example of a *Key* used for entering rock descriptions on a coring log and includes details of several of the properties listed in Table 2-7.

Rock mass that is highly-weathered, weak, and/or highly fractured can be challenging to sample using rock coring methods and may not provide samples that are sufficient for laboratory strength tests. As noted above, RQD is not meaningful for highly-weathered rock. Some transportation agencies have developed field sampling and testing methods specifically for these types of materials.

**TABLE 2-7 DESCRIPTION OF ROCK CORE FOR ENGINEERING CHARACTERIZATION.**

<b>Category</b>	<b>Property</b>
1. Rock Material Description	<i>a.</i> Rock type <i>b.</i> Wall strength (strength of intact rock) <i>c.</i> Weathering
2. Discontinuity Description	<i>d.</i> Type <i>e.</i> Orientation <i>f.</i> Roughness <i>g.</i> Aperture
3. Infilling	<i>h.</i> Infilling type and width
4. Rock Mass Description	<i>i.</i> Spacing <i>j.</i> Persistence <i>k.</i> No. of sets <i>l.</i> Block size/shape
5. Groundwater	<i>m.</i> Seepage

For example, the Colorado DOT uses soil boring equipment, SPT N-values, and pressuremeter tests (PMT) in highly-weathered weak shale and claystone to obtain properties which are correlated empirically to drilled shaft side and base resistances. The interested reader is referred to Abu-Hejleh et al. (2003) for further information.

### 2.3.3.6 Groundwater

Groundwater elevations are needed for drilled shaft design in order to assess properly the state of effective stress. Effective stress methods are used to evaluate side and tip resistances in cohesionless soils for design under axial loading (Chapter 13), for computing  $p$ - $y$  curves for design under lateral loading (Chapter 12), and for assessment of liquefaction of soil deposits under earthquake loading (Chapter 15). Groundwater levels will also be needed by contractors and engineers to establish appropriate construction methods.

Water levels encountered during drilling, upon completion of the boring, and at 24 hours after completion of boring should be recorded on the boring log. In low permeability soils such as silts and clays, a false indication of the water level may be obtained when water is used for drilling fluid since adequate time is not permitted after boring completion for the water level to stabilize (more than one week may be required). In such soils an observation well consisting of plastic pipe, or a piezometer in very low permeability soils, should be installed to allow monitoring of the water level over a period of time. Seasonal fluctuations of the water table should be determined where such fluctuations will have significant impact on design or construction. The top several feet of the annular space between water observation well pipes and the borehole wall should be backfilled with grout, bentonite, or sand-cement mixture to prevent surface water inflow which can cause erroneous groundwater level readings. The practice of using slope inclinometer casings as water observations wells by using “leaky” couplings is not recommended. Instead, separate installations dedicated to either inclinometer measurements or groundwater observations (not both) provide a preferred means to optimize each installation for its intended purpose. If artesian conditions are encountered, this is an important piece of information for drilled shaft constructability and should be indicated clearly on the boring log. Seepage zones, if encountered, should also be identified.

<b>Project:</b> <b>Project Location:</b> <b>Project Number:</b>	<b>Key to Rock Core Log</b> Sheet 1 of 2
---	---

Depth, meters	Elevation, meters	ROCK CORE								MATERIAL DESCRIPTION	Packer Tests	Laboratory Tests	Drill Rate, meters/hour	FIELD NOTES	
		Run No.	Box No.	Recovery, %	Frac. Freq.	R Q D, %	Fracture Drawing/Number	Lithology							
0															
1	2	3	4	5	6	7	8	9	10	11	13	14	15	16	
2		1	1	100		80				META-ARKOSE, light gray, moderately weathered, moderately strong.  <div style="display: flex; justify-content: space-around; border: 1px solid black; padding: 2px;"> <span>a</span><span>b</span><span>c</span><span>d</span><span>e</span><span>f</span><span>g</span><span>h</span> </div> 1: 75, J, VN, Fe, Su, Pl, S, VC M: Mechanical Breakage				Slow drilling	
4					1			1							

- 1** Depth: Distance (in meters) from the collar of the borehole.
- 2** Elevation: Elevation (in meters) from the collar of the borehole.
- 3** Run No.: Number of the individual coring interval, starting at the top of bedrock.
- 4** Box No.: Number of the core box which contains core from the corresponding run.
- 5** Recovery: Amount (in percent) of core recovered from the coring interval; calculated as the length of core recovered divided by the length of the run.
- 6** Frac. Freq.: (Fracture Frequency) The number of naturally occurring fractures in each foot of core; does not include mechanical breaks, which are considered to be induced by drilling.
- 7** R Q D: (Rock Quality Designation) Amount (in percent) of intact core (pieces of sound core greater than 100 mm in length) in each coring interval; calculated as the sum of the lengths of intact core divided by the length of the core run.
- 8** Fracture Drawing: Sketch of the naturally occurring fractures and mechanical breaks, showing the angle of the fractures relative to the cross-sectional axis of the core. "NR" indicates no recovery.
- 9** Fracture Number: Location of each naturally occurring fracture (numbered) and mechanical break (labeled "M"). Naturally occurring fractures are described in Column 11 (keyed by number) using descriptive terms defined on the following page (Items a - h).
- 10** Lithology: A graphic log presentation using symbols to represent differing rock types.
- 11** Description: Lithologic description in this order: rock type, color, texture, grain size, foliation, weathering, strength, and other features; descriptive terms are defined on the following page. A detailed descriptive log of overburden materials is not necessarily provided.
- 12** Discontinuity Description: Abbreviated description of fracture corresponding to number of naturally occurring fracture in Column 9 using terms defined on the following page (Items a - h).
- 13** Packer Tests: A vertical line depicts the interval over which a packer test is performed.
- 14** Laboratory Tests: A vertical line depicts the interval over which core has been removed for laboratory testing. Laboratory tests performed are indicated in Column 16.
- 15** Drill Rate: Rate (in meters per hour) of penetration of drilling. "N/O" indicates rate not observed.
- 16** Field Notes: Comments on drilling, including water loss, reasons for core loss, and use of drilling mud; also, laboratory tests performed on core.

Template: M4SK Proj ID: KEY

Point ID: COREKEY Printed: MAY 28 97

Figure 2-8 Example of Key to Rock Core Log (\*note: 1 meter = 3.281 ft)

<b>Project:</b> <b>Project Location:</b> <b>Project Number:</b>	<b>Key to Rock Core Log</b> Sheet 2 of 2
---	---

Depth, meters	Elevation, meters	ROCK CORE							MATERIAL DESCRIPTION	Packer Tests	Laboratory Tests	Drill Rate, meters/hour	FIELD NOTES																								
		Run No.	Box No.	Recovery, %	Frac. Freq.	R Q D, %	Fracture Drawing/Number	Lithology																													
<b>KEY TO DESCRIPTIVE TERMS USED ON CORE LOGS</b>																																					
<b>DISCONTINUITY DESCRIPTORS</b>																																					
<table style="width: 100%; border: none;"> <tr> <td style="width: 33%; vertical-align: top;"> <b>a</b> Dip of fracture surface measured relative to horizontal   <b>b</b> <b>Discontinuity Type:</b>            F - Fault            J - Joint            Sh - Shear            Fo - Foliation            V - Vein            B - Bedding         </td> <td style="width: 33%; vertical-align: top;"> <b>e</b> <b>Amount of Infilling:</b>            Su - Surface Stain            Sp - Spotty            Pa - Partially Filled            Fi - Filled            No - None         </td> <td style="width: 33%; vertical-align: top;"> <b>h</b> <b>Discontinuity Spacing (meters):</b>            EW - Extremely Wide (&gt;20)            W - Wide (7-20)            M - Moderate (2.5-7)            C - Close (0.7-2.5)            VC - Very Close (&lt;0.7)         </td> </tr> <tr> <td style="vertical-align: top;"> <b>c</b> <b>Discontinuity Width (millimeters):</b>            W - Wide (12.5-50)            MW - Moderately Wide (2.5-12.5)            N - Narrow (1.25-2.5)            VN - Very Narrow (&lt;1.25)            T - Tight (0)         </td> <td style="vertical-align: top;"> <b>f</b> <b>Surface Shape of Joint:</b>            Wa - Wavy            Pl - Planar            St - Stepped            Ir - Irregular         </td> <td></td> </tr> <tr> <td style="vertical-align: top;"> <b>d</b> <b>Type of Infilling:</b>            Cl - Clay            Ca - Calcite            Ch - Chlorite            Fe - Iron Oxide            Gy - Gypsum/Talc            H - Healed            No - None            Py - Pyrite            Qz - Quartz            Sd - Sand         </td> <td style="vertical-align: top;"> <b>g</b> <b>Roughness of Surface:</b>            Slik - Slickensided [surface has smooth, glassy finish with visual evidence of striations]            S - Smooth [surface appears smooth and feels so to the touch]            SR - Slightly Rough [asperities on the discontinuity surfaces are distinguishable and can be felt]            R - Rough [some ridges and side-angle steps are evident; asperities are clearly visible, and discontinuity surface feels very abrasive]            VR - Very Rough [near-vertical steps and ridges occur on the discontinuity surface]         </td> <td></td> </tr> </table>														<b>a</b> Dip of fracture surface measured relative to horizontal  <b>b</b> <b>Discontinuity Type:</b> F - Fault J - Joint Sh - Shear Fo - Foliation V - Vein B - Bedding	<b>e</b> <b>Amount of Infilling:</b> Su - Surface Stain Sp - Spotty Pa - Partially Filled Fi - Filled No - None	<b>h</b> <b>Discontinuity Spacing (meters):</b> EW - Extremely Wide (>20) W - Wide (7-20) M - Moderate (2.5-7) C - Close (0.7-2.5) VC - Very Close (<0.7)	<b>c</b> <b>Discontinuity Width (millimeters):</b> W - Wide (12.5-50) MW - Moderately Wide (2.5-12.5) N - Narrow (1.25-2.5) VN - Very Narrow (<1.25) T - Tight (0)	<b>f</b> <b>Surface Shape of Joint:</b> Wa - Wavy Pl - Planar St - Stepped Ir - Irregular		<b>d</b> <b>Type of Infilling:</b> Cl - Clay Ca - Calcite Ch - Chlorite Fe - Iron Oxide Gy - Gypsum/Talc H - Healed No - None Py - Pyrite Qz - Quartz Sd - Sand	<b>g</b> <b>Roughness of Surface:</b> Slik - Slickensided [surface has smooth, glassy finish with visual evidence of striations] S - Smooth [surface appears smooth and feels so to the touch] SR - Slightly Rough [asperities on the discontinuity surfaces are distinguishable and can be felt] R - Rough [some ridges and side-angle steps are evident; asperities are clearly visible, and discontinuity surface feels very abrasive] VR - Very Rough [near-vertical steps and ridges occur on the discontinuity surface]																
<b>a</b> Dip of fracture surface measured relative to horizontal  <b>b</b> <b>Discontinuity Type:</b> F - Fault J - Joint Sh - Shear Fo - Foliation V - Vein B - Bedding	<b>e</b> <b>Amount of Infilling:</b> Su - Surface Stain Sp - Spotty Pa - Partially Filled Fi - Filled No - None	<b>h</b> <b>Discontinuity Spacing (meters):</b> EW - Extremely Wide (>20) W - Wide (7-20) M - Moderate (2.5-7) C - Close (0.7-2.5) VC - Very Close (<0.7)																																			
<b>c</b> <b>Discontinuity Width (millimeters):</b> W - Wide (12.5-50) MW - Moderately Wide (2.5-12.5) N - Narrow (1.25-2.5) VN - Very Narrow (<1.25) T - Tight (0)	<b>f</b> <b>Surface Shape of Joint:</b> Wa - Wavy Pl - Planar St - Stepped Ir - Irregular																																				
<b>d</b> <b>Type of Infilling:</b> Cl - Clay Ca - Calcite Ch - Chlorite Fe - Iron Oxide Gy - Gypsum/Talc H - Healed No - None Py - Pyrite Qz - Quartz Sd - Sand	<b>g</b> <b>Roughness of Surface:</b> Slik - Slickensided [surface has smooth, glassy finish with visual evidence of striations] S - Smooth [surface appears smooth and feels so to the touch] SR - Slightly Rough [asperities on the discontinuity surfaces are distinguishable and can be felt] R - Rough [some ridges and side-angle steps are evident; asperities are clearly visible, and discontinuity surface feels very abrasive] VR - Very Rough [near-vertical steps and ridges occur on the discontinuity surface]																																				
<b>ROCK WEATHERING / ALTERATION</b>																																					
<table style="width: 100%; border: none;"> <thead> <tr> <th style="text-align: left; border-bottom: 1px solid black;">Description</th> <th style="text-align: left; border-bottom: 1px solid black;">Recognition</th> </tr> </thead> <tbody> <tr> <td>Residual Soil</td> <td>Original minerals of rock have been entirely decomposed to secondary minerals, and original rock fabric is not apparent; material can be easily broken by hand</td> </tr> <tr> <td>Completely Weathered/Altered</td> <td>Original minerals of rock have been almost entirely decomposed to secondary minerals, minerals, although original fabric may be intact; material can be granulated by hand</td> </tr> <tr> <td>Highly Weathered/Altered</td> <td>More than half of the rock is decomposed; rock is weakened so that a minimum 50-mm-diameter sample can be broken readily by hand across rock fabric</td> </tr> <tr> <td>Moderately Weathered/Altered</td> <td>Rock is discolored and noticeably weakened, but less than half is decomposed; a minimum 50-mm-diameter sample cannot be broken readily by hand across rock fabric</td> </tr> <tr> <td>Slightly Weathered/Altered</td> <td>Rock is slightly discolored, but not noticeably lower in strength than fresh rock</td> </tr> <tr> <td>Fresh</td> <td>Rock shows no discoloration, loss of strength, or other effect of weathering/alteration</td> </tr> </tbody> </table>														Description	Recognition	Residual Soil	Original minerals of rock have been entirely decomposed to secondary minerals, and original rock fabric is not apparent; material can be easily broken by hand	Completely Weathered/Altered	Original minerals of rock have been almost entirely decomposed to secondary minerals, minerals, although original fabric may be intact; material can be granulated by hand	Highly Weathered/Altered	More than half of the rock is decomposed; rock is weakened so that a minimum 50-mm-diameter sample can be broken readily by hand across rock fabric	Moderately Weathered/Altered	Rock is discolored and noticeably weakened, but less than half is decomposed; a minimum 50-mm-diameter sample cannot be broken readily by hand across rock fabric	Slightly Weathered/Altered	Rock is slightly discolored, but not noticeably lower in strength than fresh rock	Fresh	Rock shows no discoloration, loss of strength, or other effect of weathering/alteration										
Description	Recognition																																				
Residual Soil	Original minerals of rock have been entirely decomposed to secondary minerals, and original rock fabric is not apparent; material can be easily broken by hand																																				
Completely Weathered/Altered	Original minerals of rock have been almost entirely decomposed to secondary minerals, minerals, although original fabric may be intact; material can be granulated by hand																																				
Highly Weathered/Altered	More than half of the rock is decomposed; rock is weakened so that a minimum 50-mm-diameter sample can be broken readily by hand across rock fabric																																				
Moderately Weathered/Altered	Rock is discolored and noticeably weakened, but less than half is decomposed; a minimum 50-mm-diameter sample cannot be broken readily by hand across rock fabric																																				
Slightly Weathered/Altered	Rock is slightly discolored, but not noticeably lower in strength than fresh rock																																				
Fresh	Rock shows no discoloration, loss of strength, or other effect of weathering/alteration																																				
<b>ROCK STRENGTH</b>																																					
<table style="width: 100%; border: none;"> <thead> <tr> <th style="text-align: left; border-bottom: 1px solid black;">Description</th> <th style="text-align: left; border-bottom: 1px solid black;">Recognition</th> <th style="text-align: left; border-bottom: 1px solid black;">Approximate Uniaxial Compressive Strength (kPa)</th> </tr> </thead> <tbody> <tr> <td>Extremely Weak Rock</td> <td>Can be indented by thumbnail</td> <td>250 - 1,000</td> </tr> <tr> <td>Very Weak Rock</td> <td>Can be peeled by pocket knife</td> <td>1,000 - 5,000</td> </tr> <tr> <td>Weak Rock</td> <td>Can be peeled with difficulty by pocket knife</td> <td>5,000 - 25,000</td> </tr> <tr> <td>Medium Strong Rock</td> <td>Can be indented 5 mm with sharp end of pick</td> <td>25,000 - 50,000</td> </tr> <tr> <td>Strong Rock</td> <td>Requires one hammer blow to fracture</td> <td>50,000 - 100,000</td> </tr> <tr> <td>Very Strong Rock</td> <td>Requires many hammer blows to fracture</td> <td>100,000 - 250,000</td> </tr> <tr> <td>Extremely Strong Rock</td> <td>Can only be chipped with hammer blows</td> <td>&gt; 250,000</td> </tr> </tbody> </table>														Description	Recognition	Approximate Uniaxial Compressive Strength (kPa)	Extremely Weak Rock	Can be indented by thumbnail	250 - 1,000	Very Weak Rock	Can be peeled by pocket knife	1,000 - 5,000	Weak Rock	Can be peeled with difficulty by pocket knife	5,000 - 25,000	Medium Strong Rock	Can be indented 5 mm with sharp end of pick	25,000 - 50,000	Strong Rock	Requires one hammer blow to fracture	50,000 - 100,000	Very Strong Rock	Requires many hammer blows to fracture	100,000 - 250,000	Extremely Strong Rock	Can only be chipped with hammer blows	> 250,000
Description	Recognition	Approximate Uniaxial Compressive Strength (kPa)																																			
Extremely Weak Rock	Can be indented by thumbnail	250 - 1,000																																			
Very Weak Rock	Can be peeled by pocket knife	1,000 - 5,000																																			
Weak Rock	Can be peeled with difficulty by pocket knife	5,000 - 25,000																																			
Medium Strong Rock	Can be indented 5 mm with sharp end of pick	25,000 - 50,000																																			
Strong Rock	Requires one hammer blow to fracture	50,000 - 100,000																																			
Very Strong Rock	Requires many hammer blows to fracture	100,000 - 250,000																																			
Extremely Strong Rock	Can only be chipped with hammer blows	> 250,000																																			

Template: M4SK Proj ID: KEY

Point ID: COREKEY Printed: MAY 28 97

Figure 2-9 Example of Key to Rock Core Log, continued from Figure 2-8 (\*note: 1 kPa = 0.145 psi)

In rock formations, water inflow to a bored hole is controlled by seepage along discontinuities. This type of flow can vary significantly over short distances and can be a critical factor in drilled shaft construction. It is, therefore, important to observe and record rates of water inflow to exploratory boreholes in rock for its value in estimating the potential for water inflow during drilled shaft construction. It is not uncommon to observe high seepage rates in one borehole or drilled shaft excavation and little or no seepage in an adjacent hole just a short distance away.

#### **2.3.4 Information Required for Construction**

Information obtained during the subsurface investigation and described in the preceding sections is used for two general purposes: (1) drilled shaft design; and (2) drilled shaft construction. Additional information is usually required by both contractors and engineers for the purpose of establishing appropriate construction methods, selection of proper tools and equipment, making cost estimates, preparing bid documents, and planning for construction. This aspect of the site investigation cannot be overemphasized, considering the following observations: (1) the most frequently cited cause of drilled shaft failure is improper construction procedures; and (2) the most common basis for construction claims is “differing site conditions”. It follows that careful attention to the acquisition of all pertinent information about the subsurface conditions relating to construction can reduce the risk of failure and minimize the potential for cost overruns and claims. Examples of data and information required specifically for construction are given in Table 2-8.

Drilled shafts bearing on or socketed into rock pose special challenges for construction. Many designers assume the base of the shaft will bear on relatively sound or intact rock and that measures will be taken during construction to verify that assumption. It is critical for both the designer and contractor to have a common understanding of what constitutes adequate bearing conditions in rock and what measures will be taken to locate the shaft base at the proper elevation. Exploratory drilling conducted at the shaft location prior to construction should include rock coring to a depth below the base that is sufficient to determine that the rock is not a cobble or boulder (“floater”) and to verify the absence of solution cavities or zones of decomposed rock. The boring log should include a clear indication of depth to acceptable bedrock. If coring into rock is not done prior to construction, it may be necessary to core the rock within and below the design rock socket of each drilled shaft to confirm rock quality during construction. For both cases, it is advisable to establish some agreement on two issues prior to construction. First, there must be clearly-defined criteria for what constitutes adequate rock quality. This could be based on factors such as core recovery, RQD, rock strength, degree of weathering, or other parameters that can be determined in the field. Second, there must be a clear understanding regarding how to proceed when coring reveals the presence of rock that does not meet the established criteria for rock quality. This might involve excavation to greater depth. It then becomes necessary to define the method of payment for additional excavation of rock beyond the anticipated depth. There may be conditions where depth to bedrock and degree of weathering of rock exhibit such extreme variations that it becomes necessary to conduct multiple exploratory borings at the site of a single drilled shaft or to establish construction procedures that involve final determination of bearing depths during construction. For example, in some karstic environments the rock surface is pinnacled and highly variable both laterally and vertically. It may not be possible to establish base elevations until each drilled shaft is excavated and the rock at the base can be probed, cored, or inspected visually.

It is important to recognize that establishing the suitability of rock for bearing is not equivalent to defining rock for purposes of excavation and payment. A contractor has a right to be paid for rock excavation regardless of its quality as a bearing material, and pay quantities should not be based on suitability of the rock for an engineering design function.

**TABLE 2-8 INFORMATION USED FOR DRILLED SHAFT CONSTRUCTABILITY**

<b>Application</b>	<b>Information</b>
Selection of appropriate drilling equipment and tools for excavation	Presence, size, distribution, and hardness of cobbles and boulders
	Obstructions such as old foundations, pipes, construction rubble, trees, etc.
	Rate of advancement of exploratory boreholes
	Torque and crowd of the drilling machine used for exploration
	Tools and methods used for sampling
	Characteristics of rock mass (depth, strength, fracturing, RQD, weathering, etc.)
Selection of appropriate methods and materials for excavation support (dry, casing, slurry, combined)	Cohesionless soils below water table; particle size range of granular soils, including percentage fines (to assess suitability of polymer slurry use)
	Location of free water or seeps, rate of groundwater inflow, and piezometric levels; proximity of potential surface water infiltration sources (river, lake, ocean)
	Methods of support used for exploratory borings (drilling mud, casing, other); observations of caving (stand-up time); observations of fluid loss
	Hardness, pH, and chloride content of groundwater (for slurry construction)
	Environmental restrictions on use and disposal of slurry
	Anticipated base conditions and requirements for base cleanout
Match field inspection (quality assurance) procedures with construction procedures	Anticipated Non-destructive Testing methods (NDT)
	Potential use of specialized inspection tools (borehole calipers, Shaft Inspection Device (SID), downhole cameras, etc.)
	Need for supplemental borings/rock cores during construction

Where subsurface contamination is detected, special measures may be required to insure worker safety and for safe disposal of contaminated cuttings and drilling fluid. When these factors are known beforehand and made clear to all parties, proper measures can be incorporated into construction plans and the costs can be included. When contamination problems are discovered during construction, the costs of addressing safety and disposal issues can be significantly higher, involving schedule impacts as well as increased drilling and disposal costs.

An effective way to obtain critical information on drilled shaft constructability is to install one or more full-sized test excavations, referred to as a “technique shaft” (also as a “method shaft” or “trial shaft”) during the design phase or at the start of construction. A technique shaft should be of sufficient depth and diameter to reveal problems and difficulties likely to be encountered by a contractor installing production shafts at the same site. Examples of information that may not be obtained easily from exploratory borings but will be obvious during a full-sized excavation include: (a) caving or squeezing soil, especially if wash-boring techniques or rotary drilling with casing are used for site investigation, (b) presence of cobbles or boulders which could easily be missed by a small-diameter boring or be mistaken for a layer of rock, (c) elevation at which water will flow into the excavation and the rate of water inflow, and (d) conditions at the base of the shaft and effectiveness of base cleanout methods. If there are questions pertaining to placement of reinforcing cages or concrete, a technique shaft can be carried through these stages of construction as well. Technique shafts can also provide important data for design, for example, the degree of sidewall roughness for shafts in rock. It may also be possible to conduct in-situ tests, take downhole photographs, and verify assumptions about base conditions, all of which can be important for

evaluating design parameters. A technique shaft can also be combined with a pre-design load test, providing a wide range of design and constructability information and reducing uncertainty during the design phase. During construction, however, it is typical to complete the technique shaft prior to installing the test shaft so that any modifications of the means and methods of drilled shaft installation identified from the technique shaft can be applied to the test shaft and reflected in the load test results.

The information described above and collected specifically for its constructability value must be made available to bidders in order to provide them with a basis for making improved cost estimates. The same information is also needed by the engineer to forecast potential construction methods and construction problems in order to develop specifications for the project, make cost estimates, and perform risk analysis.

## **2.4 GEOTECHNICAL REPORTS**

Upon completion of the field investigation and laboratory testing program, the geotechnical engineer is responsible for reduction and interpretation of the data, construction of a model of the site geology, selection of appropriate soil and rock design parameters, and engineering analyses for the design of drilled shaft foundations. Additionally, the geotechnical engineer is responsible for producing a report that communicates the site conditions and design and construction recommendations to the other members of the design and construction teams. The information contained in this report is referred to often during the design and construction phases, and frequently after completion of the project (resolving claims). Therefore, the report must be clear, concise, and accurate.

Two types of geotechnical report are relevant to drilled shafts: (1) a geotechnical investigation (or data) report; and (2) a geotechnical design report. The choice depends on the requirements of the transportation agency (owner) and the agreement between the geotechnical engineer and the facility designer.

### **2.4.1 Geotechnical Investigation Report**

A geotechnical investigation report is limited to documenting the investigation performed and presenting the data obtained. This type of report typically does not include interpretations of the subsurface conditions or design recommendations. The geotechnical investigation report is sometimes used when the field investigation is subcontracted to a consultant but the data interpretation and design tasks are to be performed by the owner's or the prime consultant's in-house geotechnical staff. This type of report may also be used to provide bidders with only factual data for their interpretation of design and construction requirements, such as on design-build projects. Three categories of information are presented in a geotechnical investigation report, as summarized in Table 2-9. The report should also include a summary of the subsurface and laboratory data.

### **2.4.2 Geotechnical Design Report**

A geotechnical design report, also called a foundation report, typically provides an assessment of existing subsurface conditions at the project site, presents geotechnical analyses, and provides appropriate recommendations for design and construction of drilled shaft foundations for the bridge, retaining wall, or other facility. Unless a separate investigation (data) report has been prepared, the geotechnical design report will incorporate all of the information described in Section 2.4.1 that is covered in a geotechnical investigation report. The report should always make a clear distinction between information which is factual and information which is qualified or interpretive.



**TABLE 2-9 INFORMATION INCLUDED IN GEOTECHNICAL INVESTIGATION REPORT**

1. Background Information	Overview of project (bridge, structure, retaining wall, or other facility)
	General site conditions (geology, topography, drainage, ground cover, accessibility)
	Specific methods used for site exploration
2. Scope of Site Investigation	Plans showing locations of all borings, test pits, and in-situ test holes
	Number, locations, and depths of all borings and in-situ tests
	Types and frequency of samples obtained; standards used
	Types and numbers of laboratory tests; standards used
	Subcontractors performing the work and dates of work
	Soil and rock classification systems used
3. Data Presentation (appendixes)	Final logs of all borings and test pits
	Water level readings and other groundwater data collected
	Data tabulations and plots from each in-situ test hole
	Summary tables and data sheets for lab tests performed
	Rock core photographs
	Results of geophysical testing
	Geologic mapping data sheets and summary plots
	Subsurface profiles from field and lab test data; statistical summaries
Existing information from previous investigations (boring logs, data)	

The report must identify each soil and rock unit of engineering significance and recommend design parameters for each of these units. This requires a summary and analysis of all factual data to justify the recommended index and design properties. Groundwater conditions are particularly important for both design and construction and, accordingly, they need to be assessed carefully and described.

Each design issue, for example axial resistance, response to lateral loading, settlement analysis, group behavior, etc., must be addressed in accordance with the methodologies described in subsequent chapters of this manual and the results need to be discussed concisely and clearly in the report. Of particular importance is an assessment of the impact of existing subsurface conditions on drilled shaft construction. Relevant items identified in Table 2-8 should be discussed in terms of their potential impact on constructability, providing contractors with the information necessary for them to decide how to construct the drilled shafts.

The design report should also recommend the specifications to be used for drilled shafts. These could be the standard specifications or specifications that are revised to fit the needs of the contract (“special provisions”). The language to be included in specification special provisions should be recommended in the design report. This could include Geotechnical Advisory Statements – statements such as ‘although no boulders were encountered in the borings, boulders are expected to be encountered in drilled shaft construction, based on known geologic conditions’ or ‘groundwater elevation is seasonal and is anticipated that it could be several feet higher than encountered in the borings’. Such advisory statements must be supported by geologic or hydrologic information gathered by the site investigation and described in the report, and not used as blanket statements in an attempt to defeat legitimate claims for differing site conditions (Section 2.4.4).

The geotechnical design report should include recommendations for a drilled shaft load test program (Chapter 17), if required. This is especially critical when the design parameters are based on an assumed level of testing. The report should also address drilled shaft integrity testing (Chapter 20) and field inspection requirements.

### 2.4.3 Data Presentation

Boring logs, rock coring, soundings, and exploration logging should be prepared in accordance with standardized procedures and formats. Most state transportation agencies have standard formats for presentation of boring data. Exploration logs can be prepared using software capable of storing, manipulating, and presenting geotechnical data in simple one-dimensional profiles, or alternatively two-dimensional graphs (subsurface profiles), or three-dimensional representations. These and other similar software allow the orderly storage of project data for future reference. Links to software packages for preparation of soil boring logs may be found at the following websites: <http://www.ggsd.com> and <http://www.usucger.org>. Alternatively, it is convenient for the in-situ test data to be reduced directly and simply using a spreadsheet format. The spreadsheet approach allows the engineer to tailor the interpretations to account for specific geologic settings and local formations. The spreadsheet also permits creativity and uniqueness in the graphical presentation of the results, thereby enhancing the abilities and resources available to the geotechnical personnel. Field data entered into a spreadsheet also facilitates calculations of resistances directly from in-situ test results.

A site location plan should be provided for reference on a regional or local-scale map, for example, county or city street maps or USGS topographic quad maps. Locations of all field tests, sampling, and exploratory studies should be shown clearly on the scaled map of the site. Preferably, the plan should be a topographic map with well delineated elevation contours and a properly-established benchmark. The direction of magnetic or true north should be shown. Additionally, site location maps can be plotted directly on air photos. An example of this type of map is shown in Figure 2-10. A *geographic information system* (GIS) can be utilized to document the test locations in reference to existing facilities such as utilities, roadways and bridges, culverts, buildings, or other structures. Recent advances have been made in portable measuring devices that utilize *global positioning systems* (GPS) to permit quick and approximate determinations of coordinates and elevations of test locations and installations.

Geotechnical reports are normally accompanied by the presentation of subsurface profiles developed from field and laboratory test data. Longitudinal profiles are typically developed along the bridge alignment, and a limited number of transverse profiles may be included for key locations such as at bridge foundations. Subsurface profiles, coupled with judgment and an understanding of the geologic setting, aid the geotechnical engineer in the interpretation of subsurface conditions between the investigation sites. In developing a two-dimensional subsurface profile, the profile line (typically the roadway or bridge centerline) needs to be defined on the base plan, and the relevant borings projected to this line. A representative example of an interpreted subsurface profile is shown in Figure 2-11. In the example, the subsurface profile shows an interpretation of the location, extent, and nature of subsurface formations or deposits between borings. At a site where rock or soil profiles vary significantly between boring locations, the value of such presentations becomes limited. The geotechnical engineer must be cautious in presenting such data, and should include clear and simple caveats explaining that the profiles between borings are subject to interpretation and are not known quantities. Should there be a need to provide more reliable continuous subsurface profiles, additional borings can be conducted and/or geophysical methods can be used to better define the subsurface conditions.



Figure 2-10 Example of Site Investigation Plan Location Map, Sacramento River Bridge Replacement (Courtesy of Caltrans)

#### 2.4.4 Differing Site Conditions

A common source of contractor claims on drilled shaft construction projects is for “differing site conditions” (DSC). Federal law requires that a DSC clause be incorporated into all Federal-Aid Highway Projects. Drilled shaft construction involves inherent risk of encountering conditions differing from those anticipated due to the complexity and variability of natural earth and rock formations and materials. The purpose of the DSC clause is to provide contractors with legal grounds for recovering costs to which they are rightfully entitled when conditions are encountered that differ materially from what a contractor could reasonably anticipate based on the documents available at the time of bidding. Inclusion of a DSC clause is also intended to induce contractors to limit contingencies in their bids, thus promoting lower initial pricing. The best approach for minimizing DSC claims is to conduct a thorough site investigation and to disclose all relevant information to contractors bidding on the project.

Geotechnical Engineering Notebook Issuance GT-15 (FHWA, 1996) was prepared to provide guidance to design and construction engineers on the topic of geotechnical differing site conditions. This guideline provides information on adequate site investigation, disclosure and presentation of subsurface information by highway agencies, and the use of such information in mitigating or resolving contractor claims of differing site conditions. Recommendations are provided for disclosure of factual, qualified, and interpretive geotechnical information. A major point made in GT-15 is that the best way to reduce the risk of geotechnical construction problems is early recognition of geotechnical problems during the design stage and designing accordingly. This normally means conducting an adequate subsurface investigation in advance of final design.

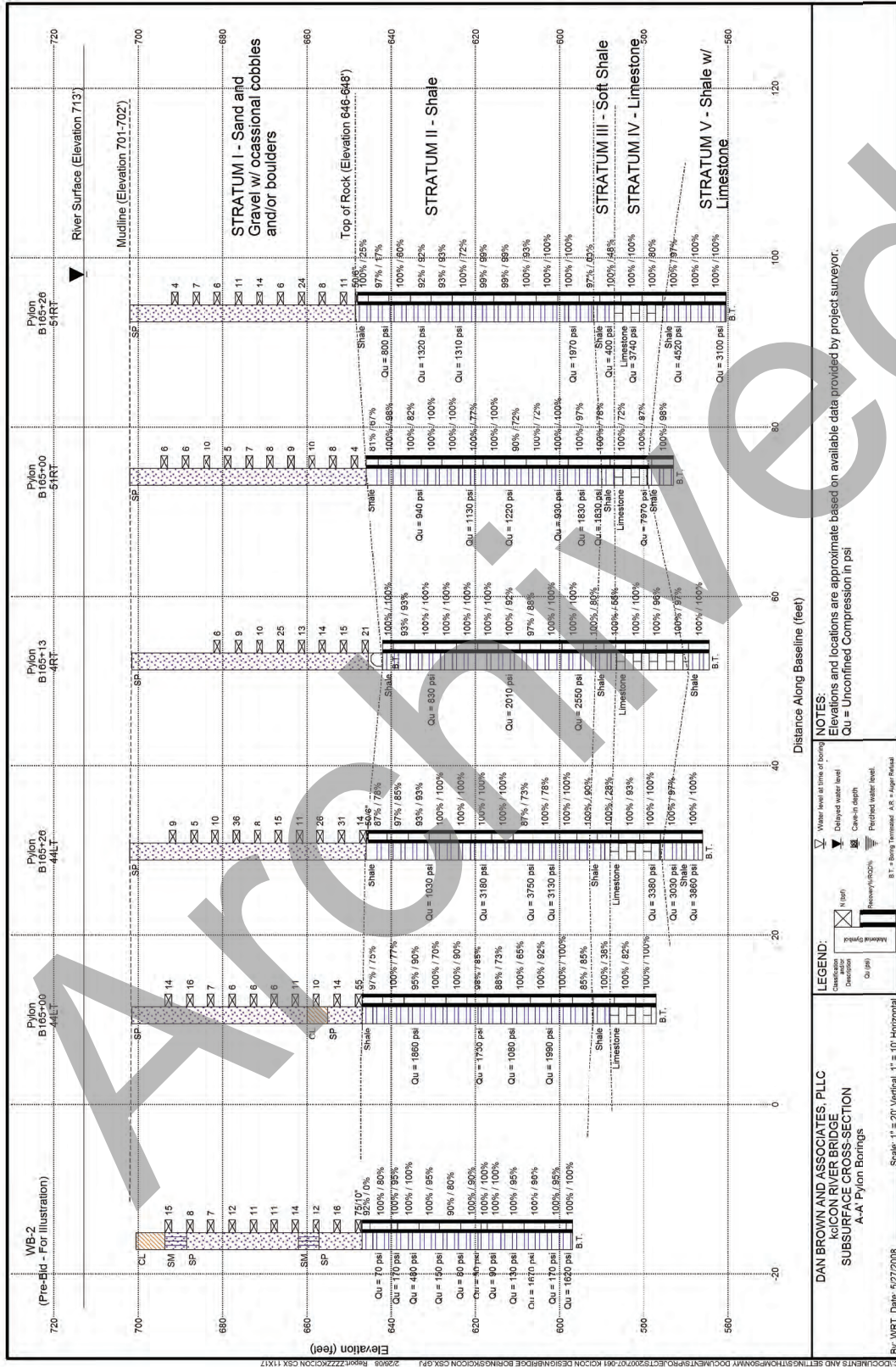


Figure 2-11 Example Subsurface Profile for a Bridge Site

The complete disclosure of all available subsurface information in the contract documents, which is required by law, is an important factor in both preventing contractor claims and in obtaining fair bids for the work to be performed. Subsurface information may be presented in detail in either the contract documents or made available at a central location for bidder inspection. The amount of subsurface information actually presented and the method of presentation in the contract documents can vary depending on the complexity of the project.

#### **2.4.5 Geotechnical Baseline Report**

The concept of Geotechnical Baseline Report (GBR) was developed in response to the high costs and uncertainties associated with tunnel construction in the U.S. in the 1970's. A GBR differs from the conventional geotechnical report in that it provides an explicit interpretation of the subsurface conditions anticipated during the proposed construction. In addition to presenting the factual information listed in Table 2-9 and recommendations for design, the intent of a GBR is to establish a realistic, common basis for contractors to use in preparing their bids and subsequently as a basis for evaluating contractor claims for differing site conditions. Disclaimers of the geologic and geotechnical conditions, which are normally included in conventional geotechnical reports, do not appear in a GBR. The contractor not only has a legal right to rely on the GBR but is required to do so.

The GBR concept has not been applied widely in the drilled shaft industry. However, the concept is being proposed for expansion to all projects involving subsurface construction (Essex, 2007) and is becoming common in design/build projects. For transportation agencies and geo-professionals involved in site characterization, the GBR concept offers both increased opportunities and increased risk. It is likely that foundation engineers will need to be familiar with this type of report for drilled shaft projects in the future.

#### **2.5 Summary**

This chapter provides an overview of the site characterization process for drilled shaft foundations. Site characterization is a critical element of the overall process of drilled shaft design and construction. All of the soil and rock properties used to design drilled shafts, as well as all information related to the subsurface conditions used to select appropriate construction methods, must be obtained through the site characterization study. Table 2-1 identifies the soil and rock properties needed for drilled shaft engineering. Methods of site characterization and their application to drilled shafts are then described, including collection of existing data, geophysical methods, boring and sampling, and rock coring. Recommendations are presented for preparing geotechnical investigation reports and geotechnical design reports for drilled shaft projects. More detailed information on in-situ and laboratory tests for establishing soil and rock properties is presented in the next Chapter (Chapter 3).

Archived

This page is intentional left blank.

## CHAPTER 3

### GEOMATERIAL PROPERTIES FOR DRILLED SHAFT FOUNDATIONS

Chapter 2 outlined the overall process of site characterization for drilled shaft design and construction. In this chapter, specific methods used to establish the physical and engineering properties of geomaterials are described. In-situ and laboratory tests are the primary means of establishing soil and rock properties and the relevant tests are identified and discussed. The focus is on properties identified in Chapter 2 which are most relevant to drilled shaft foundation engineering (see Table 2-1). In this chapter and in later chapters on drilled shaft design, all geomaterials are placed into one of the following four categories: (1) cohesionless soil, (2) cohesive soil, (3) rock, and (4) cohesive intermediate geomaterial (IGM).

#### 3.1 IN-SITU TESTING

In-situ tests are used to estimate soil and rock properties that are used for both design and construction of drilled shafts. In-situ tests offer several benefits in comparison to laboratory tests, including: (1) testing of a larger volume of material, thus providing more accurate measurement of soil or rock mass behavior, (2) measurements are made at the in-situ moisture content and under the in-situ state of stress, (3) for some tests (*e.g.* cone penetration) a continuous subsurface profile is developed, thus giving a detailed record of stratigraphy, (4) measurements are possible in materials that are difficult to sample, and (5) prompt interpretation of results. Limitations of in-situ testing include ill-defined boundary conditions and soil disturbance caused by advancing the test device, both of which can be difficult to evaluate quantitatively. Therefore, relationships between in-situ measurements and soil or rock properties are largely empirical. The approach recommended herein is to utilize in-situ tests in combination with conventional exploration methods and laboratory testing of soil and rock samples.

Common in-situ tests in soil include: standard penetration (SPT), cone penetration (CPT), piezocone (CPTu), flat dilatometer (DMT), pressuremeter (PMT), and vane shear (VST). In rock, available in-situ tests include pressuremeter (PMT) and borehole jack. Each test applies different loading schemes to measure the corresponding soil response in an attempt to evaluate material properties such as strength and/or stiffness. Figure 3-1 depicts the various devices used in soil and simplified procedures in graphical form. Table 3-1 is a summary of in-situ tests that have applications to drilled shaft design, including applicable ASTM and AASHTO standards. The most widely employed in-situ test for foundation design in U.S. practice, including drilled shafts, is the SPT. CPT and CPTu are increasing in use, are typically more economical than SPT borings, and provide more detailed stratigraphic profiling. A brief summary of the equipment, operation, application, advantages and disadvantages is presented for each of these tests. Other in-situ tests, including DMT, PMT, VST, and dynamic cone have seen more limited use in practice for drilled shaft design, but offer the ability to provide important design parameters. Only a brief overview is provided of these tests. The engineering properties correlated with each test are discussed in Section 3.2.

##### 3.1.1 Standard Penetration Test

The standard penetration test (SPT) is performed during the advancement of a soil boring to obtain a disturbed sample with the standard split spoon device and an approximate measure of the soil resistance. The SPT procedure consists of driving a 2 inch O.D., 1-3/8 inch I.D. split-spoon sampler into the soil with a 140 lb mass dropped from a height of 30 inches. The sampler is driven to a total penetration of 18 inches or 24 inches and the blow counts for each 6-inch increment are recorded. The initial 6-inch increment is considered a seating drive. The number of blows required to advance the sampler from a

penetration depth of 6 inches to 18 inches is the SPT resistance value,  $N$ , recorded in blows per foot. A head of water must be maintained in the hole at or above the groundwater level to avoid piping at the bottom of the hole, which may loosen the soil and invalidate the test results.  $N$  is always recorded as an integer. A test is ended and noted as “refusal” if 50 blows over a 1-inch increment is observed. At this point, the blows per inch is recorded (*i.e.*, 100/2 inch or 50/1 inch). If the  $N$ -value is less than one, then the engineer or geologist should record that the penetration occurred due to the weight of the hammer (WOH) or the weight of rods (WOR). SPT refusal can also be used as a practical means to define the top of rock; however, this requires prior knowledge of the site geology (nature of the soil-rock interface) and can be misleading if the rock is actually a boulder or if soil underlies rock. In those cases it is possible to core through the rock and continue SPT sampling in underlying soil layers.

The disturbed sample of soil retrieved in the split-spoon sampler should be examined visually and described in the field by a qualified geologist, geotechnical engineer, or trained technician. Changes in soil characteristics should be noted and recorded on the field boring log in order to evaluate soil stratigraphy (Figure 3-2). The total recovery of soil over the 18-inch depth should also be recorded. Samples should then be placed immediately into jars or sample bags for transport to the laboratory where they will be used for index tests and further classification.

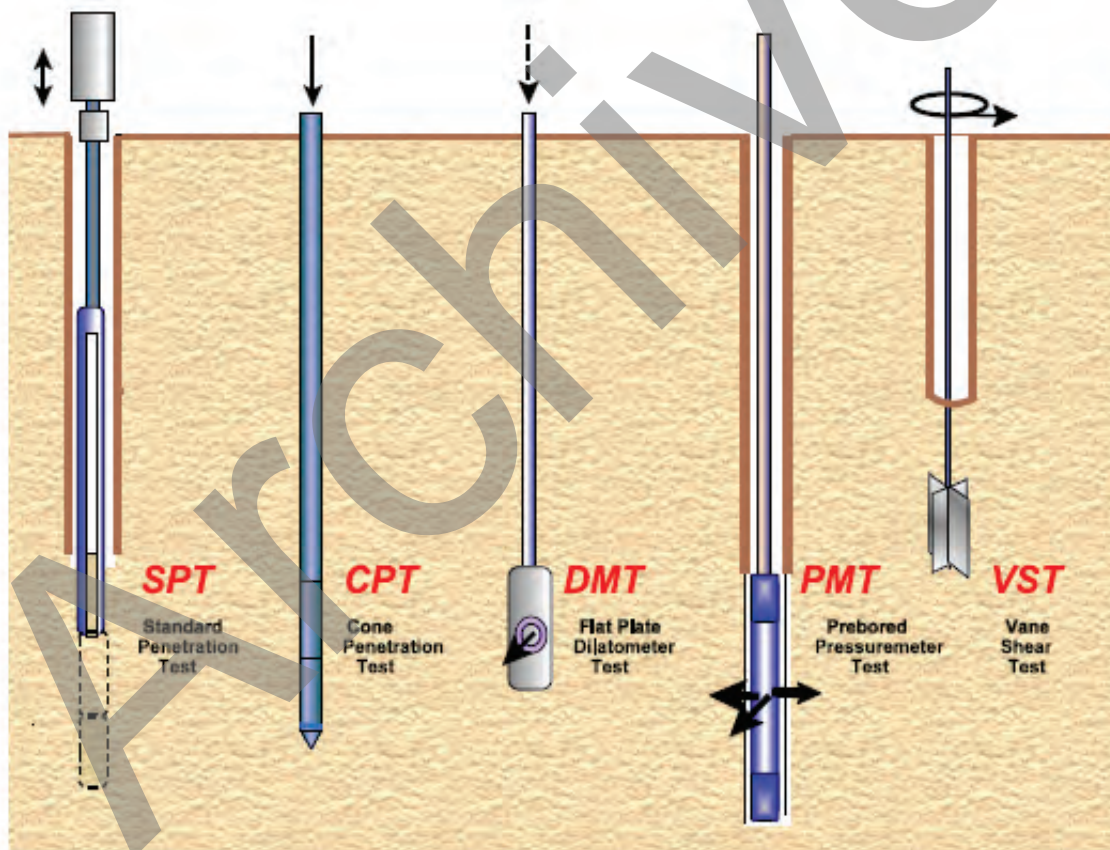


Figure 3-1 Schematic of Common In-Situ Tests (Mayne et al., 2001)



**TABLE 3-1 IN-SITU TESTS IN SOIL WITH APPLICATION TO DRILLED SHAFT DESIGN**

Type of Test	Information Relevant to Drilled Shaft Foundation Design	Advantages	Disadvantages	Remarks
Standard Penetration Test (SPT) ASTM D-1586	Correlations for in-situ density, coefficient of horizontal soil stress, and friction angle of cohesionless soils. Correlations for base resistance in cohesionless soils	<ol style="list-style-type: none"> <li>Simple to perform</li> <li>Equipment widely available</li> <li>Drillers very familiar with test</li> <li>Provides a disturbed sample for soil classification</li> </ol>	<ol style="list-style-type: none"> <li>Numerous sources of error</li> <li>Sample is disturbed</li> </ol>	Most commonly used test worldwide
Cone Penetration Test (CPT) ASTM D-3441 (mechanical) ASTM D-5778 (electronic).	Continuous evaluation of subsurface stratigraphy. Correlations for in-situ density, friction angle, and liquefaction susceptibility of sands, undrained shear strength of clays.	<ol style="list-style-type: none"> <li>Cone considered as a model pile.</li> <li>Quick and simple test.</li> <li>Can reduce number of borings and cost.</li> <li>Relatively operator independent.</li> </ol>	<ol style="list-style-type: none"> <li>Does not provide sample.</li> <li>Should be used in conjunction with soil borings.</li> <li>May require local correlations</li> <li>Cannot penetrate dense soils.</li> </ol>	Well suited to the design of axially loaded drilled shafts.
Cone Penetration Test with Pore Pressure Measurements (CPTu) ASTM D-5778	Finer delineation of stratigraphy than CPT. Correlations for in-situ density, friction angle, and liquefaction susceptibility of sands, undrained shear strength of clays.	<ol style="list-style-type: none"> <li>Same as CPT.</li> <li>Pore pressure measurements can be used to assess soil setup effects.</li> <li>Can help determine if penetration is drained or undrained.</li> </ol>	<ol style="list-style-type: none"> <li>Same as CPT</li> <li>Location and saturation of porous filter can influence pore pressure measurements.</li> </ol>	Well suited to the design of axially loaded drilled shafts.
Pressuremeter Test (PMT) ASTM D-4719	Bearing capacity from limit pressure and compressibility from PMT deformation modulus; p-y curves for lateral load analysis	<ol style="list-style-type: none"> <li>Tests can be performed in and below hard strata that may stop other in-situ testing devices.</li> <li>Tests can be made on nonhomogenous soil deposits.</li> </ol>	<ol style="list-style-type: none"> <li>Bore hole preparation very important.</li> <li>Limited number of tests per day.</li> <li>Limited application for axially loaded drilled shaft design.</li> </ol>	Good application for analysis of lateral loading.
Dilatometer Test (DMT)	Correlations for soil type, earth pressure at rest, overconsolidation ratio, friction angle of sands, undrained shear strength, and dilatometer modulus.	<ol style="list-style-type: none"> <li>Quick, inexpensive test.</li> <li>Relatively operator independent.</li> </ol>	<ol style="list-style-type: none"> <li>Less familiar test method.</li> <li>Intended for soils with particle sizes smaller than fine gravel.</li> <li>Difficulty advancing into dense and coarse soils.</li> <li>Requires correlation to local soil deposits.</li> </ol>	May be applicable to laterally loaded shaft design. ASTM standard in progress.
Vane Shear Test AASHTO T223	Undrained shear strength.	<ol style="list-style-type: none"> <li>Quick and economical.</li> <li>Compares well with unconfined compression test results at shallow depths.</li> <li>Provides peak and remolded strengths and sensitivity.</li> </ol>	<ol style="list-style-type: none"> <li>Can be used to depths of only 13 to 20 ft without casing bore hole.</li> </ol>	Used with caution in fissured, varved, and highly plastic clays.
Dynamic Cone Test	Qualitative evaluation of soil density. Qualitative comparison of stratigraphy.	<ol style="list-style-type: none"> <li>Can be useful where static cone (CPT) reaches refusal.</li> </ol>	<ol style="list-style-type: none"> <li>An unknown fraction of resistance is due to side friction.</li> <li>Overall use is limited.</li> </ol>	Not recommended for final design.



Figure 3-2 Split-Spoon Sampler for Determination of Soil Stratigraphy

Sources of error and uncertainty are associated with the energy efficiency of the equipment, details of the procedure followed, effects of overburden stress, and other factors. The test is not recommended in gravelly soils, soft clays, or cohesionless silts. Despite its limitations, the SPT is widely accepted in U.S. practice (and worldwide) and is often the primary source of information on soil properties. Research has led to correlations that allow some of the most important variables to be taken into account, in particular: (1) energy efficiency of the equipment, and (2) effective overburden stress at the test depth.

The kinetic energy delivered to the sampler varies with hammer type (*i.e.*, donut, safety, automatic) and manufacturer, hammer maintenance, and operator performance. The average energy efficiency is defined as the ratio of measured kinetic energy to potential energy expressed as a percentage. Research has shown that average energy efficiency averages approximately 60 percent in U.S. practice and, therefore, SPT correlations have been developed on the basis of a standard-of-practice corresponding to 60 percent efficiency. The energy efficiency of each SPT hammer and operator can be measured for calibration according to procedures given in ASTM D-4633. Field N-values are then adjusted to the equivalent value corresponding to 60 percent efficiency as follows:

$$N_{60} = N \left( \frac{ER}{60} \right) \quad 3-1$$

where:  $N_{60}$  = N value corrected to 60 percent efficiency,  $N$  = field measured SPT N-value, and  $ER$  = energy efficiency (%) as determined by measurements in accordance with ASTM D-4633. Additional corrections may be needed for borehole diameter, use of a liner, and rod length. In general these are only significant in unusual cases or where there is variation from standard procedures. GEC No. 5 (Sabatini et al., 2002) provides general guidance on these correction factors. The energy-corrected  $N_{60}$  value may be normalized for the effects of overburden stress, designated  $(N_1)_{60}$ , before being used in some correlations between N-values and soil properties, as follows:

$$(N_1)_{60} = N_{60} \left( \frac{p_a}{\sigma'_{vo}} \right)^n \quad 3-2$$

where:  $p_a$  = atmospheric pressure,  $\sigma'_{vo}$  = vertical effective stress at the sample depth,  $p_a$  and  $\sigma'_{vo}$  are given in consistent units, and  $n$  = exponent typically equal to 1 in clays and 0.5 in sandy soils. In Section 3.2, SPT N-values are correlated to strength properties used for drilled shaft design.

### 3.1.2 Cone Penetration Test

The cone penetration test (CPT) offers a cost-effective and fast means to obtain quality information on subsurface stratigraphy and evaluation of soil properties for drilled shaft design. Originally the CPT was based on a mechanical device but has since been largely replaced by electronic equipment. Penetrometers equipped with porewater pressure transducers, referred to as piezocone and designated CPTu, are also in wide use. Depending upon equipment capability as well as soil conditions, 300 to 1200 ft of penetration testing may be completed in one day. Mayne (2007) provides a detailed treatment of CPT testing and its application to geotechnical engineering in transportation projects.

The CPT procedure consists of pushing a cylindrical steel probe with a conical tip into the ground while measuring continuously the resistance to penetration. The standardized procedure specifies a rate of penetration of 0.8 inches/second, which typically requires a hydraulic ram with a thrust capability of 10 to 40 kips. The standard penetrometer has a conical tip with a 60 degree angle apex, a 1.4 inch diameter body (1.5 in<sup>2</sup> projected area), and a cylindrical friction sleeve with a surface area of 22.5 in<sup>2</sup>. Built-in load cells are used to monitor the force carried by the tip and sleeve. The tip force per unit of projected area is designated as the cone tip resistance,  $q_c$ , while the force carried by the sleeve distributed over the sleeve surface area is designated as the sleeve friction,  $f_s$ . The ratio of sleeve friction to cone tip resistance is the friction ratio, normally expressed as a percentage. The ASTM standard also permits a larger cone of 1.72-inch diameter, giving a 2.32 in<sup>2</sup> tip area, and a 31 in<sup>2</sup> sleeve. Figure 3-3 shows typical cone penetration equipment.

Cone penetration testing can be used in soils ranging from very soft to hard clays and loose to dense sands. The maximum depth of penetration will decrease with increasing stiffness/density, and will also depend upon the thrust capacity of the ram and the weight of the rig providing the reaction. In some locations a major limitation of the test may be the inability to penetrate hard or dense layers. This limitation can be overcome by using the cone in a boring advanced through the hard strata by rotary drilling or other means. When used appropriately, the test provides high-quality quantitative information on subsurface conditions but does not provide soil samples. Therefore, it is best used in conjunction with conventional test borings, for example auger borings with split spoon sampling and SPT measurements.

The piezocone (CPTu), is essentially the same as the standard electronic friction cone but with added transducers to measure penetration porewater pressures during the advancement of the probe. In clean sands, the measured penetration pore pressures are nearly hydrostatic because the high permeability of the sand permits immediate dissipation. In clays, however, the undrained penetration results in the development of excess porewater pressures,  $\Delta u$ , above hydrostatic. The excess  $\Delta u$  can be either positive or negative, depending upon the specific location of the porous element (filter stone) along the cone probe and the soil response. If the penetration is stopped, the decay of porewater pressures can be monitored with time and used to infer the rate of consolidation and soil permeability. The measurement of porewater pressures requires careful preparation of the porous elements and cone cavities to ensure saturation and reliable measurements of  $\Delta u$  during testing.

Data obtained from CPT/CPTu testing provide a continuous record of subsurface stratigraphy. Figure 3-4 shows a widely used chart for classifying soils from data obtained from a standard electric cone (left side) and piezocone (right side).



(a)



(b)

Figure 3-3 Cone Penetration Test Equipment (Mayne et al., 2001); (a) Typical Piezocones; and (b) Truck Mounted CPT Rig

Note that the soil descriptions in Figure 3-4 do not necessarily correspond to formal classification categories based on grain size distribution, but provide general distinctions based on expected behavior. The left side of Figure 3-4 is used to categorize soil type based on the normalized CPT cone tip resistance and friction ratio. The right side correlates soil type to normalized tip resistance and normalized pore pressure measurements from piezocone (CPTu). Whenever possible, CPT/CPTu classifications from published correlations such as those shown in Figure 3-4 should be calibrated to local conditions and experience. Correlations between CPT/CPTu data and soil strength properties are discussed in Section 3.2.

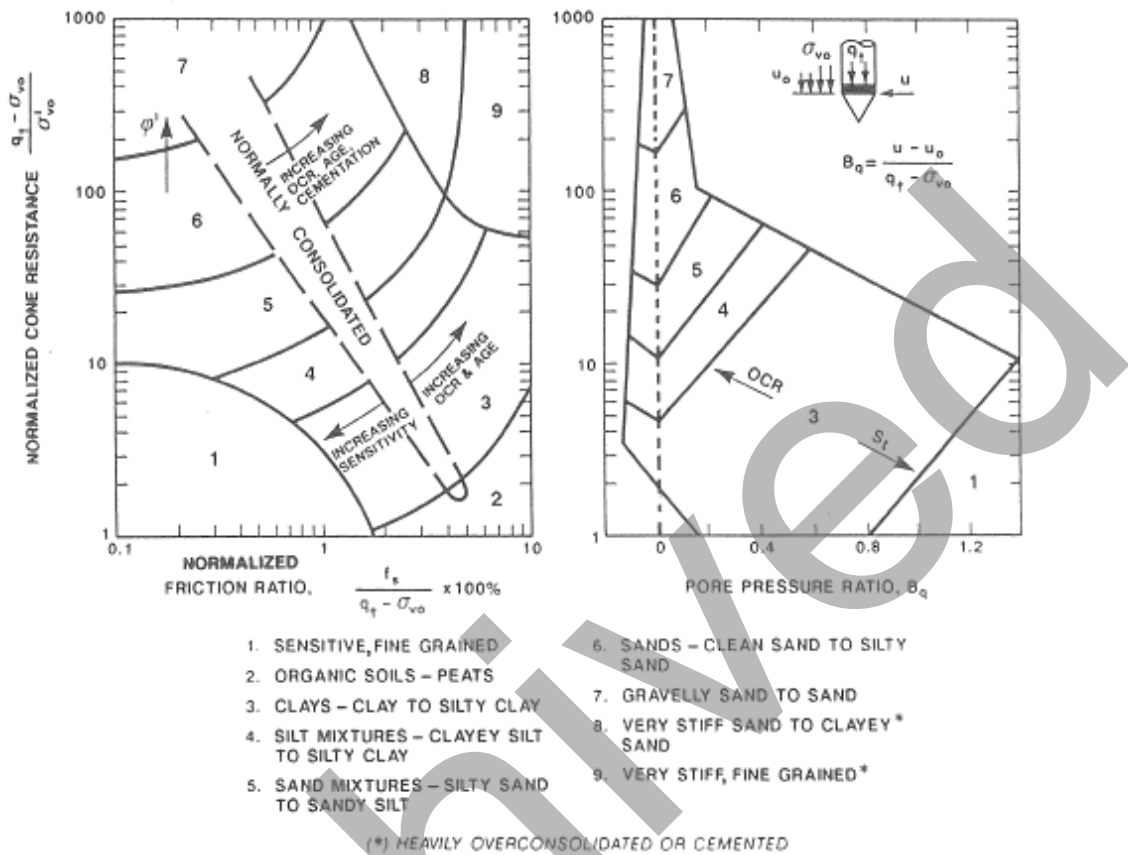


Figure 3-4 Soil Behavior Type Classification Chart Based on Normalized CPT and CPTu Data (Robertson, 1990)

### 3.2 SOIL PROPERTIES

Physical characteristics of geomaterials can be placed into two general categories: index properties and engineering properties. *Index properties* are useful for distinguishing between different soil and rock types and this is the primary information used to establish the site stratigraphy. In Chapters 12 and 13, subsurface conditions at the location of each drilled shaft are idealized by subdividing the ground into a finite number of geomaterial layers. Index properties provide the basis for assigning a geomaterial type to each layer. Index tests are used by contractors and engineers to establish appropriate methods of drilled shaft construction. For example, the presence of uncemented cohesionless soils below the water table would exclude the possibility of drilling without either casing or slurry. Index tests for soil are described in numerous engineering textbooks and manuals, such as Terzaghi et al. (1996) and Samtani and Nowatzki (2006), and detailed testing procedures are given in the applicable AASHTO (1992) and ASTM (1997) standards. *Engineering properties*, which have a direct bearing on the behavior of soil and rock masses during and after construction, include shear strength, compressibility, and permeability. Shear strength is used to calculate foundation resistances while compressibility is used to analyze load-displacement behavior. Permeability is not used directly in drilled shaft design and typically is not determined, although in some cases knowledge of permeability may be useful in assessing water inflow during construction.

### 3.2.1 Soil Index Properties and Classification

For drilled shaft design and construction, soils should be classified according to the Unified Soil Classification System (USCS). Index tests required for USCS classification include particle size analysis and Atterberg limits. Other index tests useful for drilled shaft analysis are water content and unit weight. Table 3-2 summarizes the index tests and related classification methods.

The tests listed in Table 3-2 are routine and inexpensive. When used in combination with field boring logs and geophysical tests, soil classification provides a means for correlating soils from several borings in order to estimate the subsurface stratigraphy between borings. For drilled shaft design, each geomaterial layer providing support will be placed into one of four categories that will determine the appropriate equations for calculating resistance. The categories are (1) cohesionless soils, (2) cohesive soils, (3) rock, and (4) cohesive IGM. For soils (Categories 1 and 2) the basis for categorizing materials into one or the other is the USCS classification.

**TABLE 3-2 SOIL INDEX PROPERTIES USED IN DRILLED SHAFT FOUNDATION ENGINEERING**

Test	Index Property Determined	Soil Types	Applications	Standards for Test Procedure
Particle size distribution (mechanical and hydrometer analysis)	Grain size distribution curves	Sieve on all soils; Hydrometer on minus #200	USCS classification	ASTM D 422 AASHTO T88
Atterberg Limits	Liquid limit (LL)	Minus #40 sieve	USCS classification	ASTM D 4318 AASHTO T89 (LL) AASHTO T90 (PL)
	Plastic limit (PL)			
	Plasticity index (PI) PI = LL - PL			
	Liquidity index (LI) LI = (w <sub>n</sub> - PL)/PI			
Water content	Water content, w <sub>n</sub>	Best on undisturbed samples; split-spoon samples subject to moisture change	Required for liquidity index (soil consistency index)  Helps to define zone of seasonal moisture change; swell potential	ASTM D 2216 AASHTO T265
Unit weight (undisturbed samples)	Total unit weight (density)	Fine-grained (cohesive)	Required to evaluate state of stress underground	ASTM D 1587 AASHTO T38
Soil Classification	USCS Group Symbol and Group Name	All soils	Distinguishes soils on the basis of physical characteristics	ASTM D 2487

### 3.2.2 Shear Strength Properties

Shear strength properties of geomaterials are used to evaluate drilled shaft nominal resistances. The most commonly used expression for soils is the Mohr-Coulomb failure criterion, given by:

$$\tau = c + \sigma \tan \phi \quad 3-3$$

in which  $\tau$  = shear stress at failure (shear strength),  $c$  = cohesion intercept, and  $\phi$  = friction angle. Equation 3-3 is normally expressed in one of two forms depending upon whether it is being used for

strength calculations in terms of effective stress or in terms of total stress. When effective stress analysis is conducted, Equation 3-3 is given as:

$$\tau = \sigma' \tan \phi' \quad 3-4$$

in which  $\sigma'$  = effective normal stress and  $\phi'$  = effective stress friction angle. Effective stress cohesion  $c'$  is assumed equal to zero in most cases. Soils that exhibit true effective stress cohesion include cemented soils, partially saturated soils, and heavily overconsolidated clays. For these special cases,  $c'$  could be included in Equation 3-4 but before using  $c'$  in design careful evaluation should be undertaken to determine that cohesion exists and that it is not affected adversely by disturbance during drilled shaft construction.

Equation 3-3 can be expressed in terms of total stress when applied to fine-grained cohesive soils under short-term, undrained loading. Within the context of total stress, the friction angle is taken as  $\phi = 0$  and Equation 3-3 is expressed as:

$$\tau = c = s_u \quad 3-5$$

in which the special case of total stress cohesion is defined as the *undrained shear strength* and is denoted by  $s_u$  (some authors use  $c_u$ ). The total stress analysis of strength as given by Equation 3-5 is adopted for simplicity for loading situations where the state of effective stress is unknown. This occurs when low-permeability soils such as clays are loaded relatively rapidly (*e.g.*, end of construction), resulting in generation of excess pore water pressure  $\Delta u$  of unknown magnitude, making it difficult or impossible to evaluate strength in terms of effective stress. The tradeoff for simplicity is that undrained shear strength is not a unique or fundamental property of a given soil, but one that is a function of  $\phi'$  and  $\Delta u$  and which will vary, therefore, with in-situ effective stress (and depth), stress history, water content, rate of loading, and other variables. It follows that  $s_u$  can only be determined for a particular set of conditions, the most important of which are water content, initial state of effective stress, and stress history.

### 3.2.2.1 Effective Stress Friction Angle, Cohesionless Soils

Detailed studies of the peak friction angle of granular soils such as sands show that  $\phi'$  is controlled fundamentally by mineralogical composition of the particles, magnitude of effective confining stress, and the packing arrangement (density) of the particles (Bolton 1986). A practical approach for evaluation of  $\phi'$  for drilled shaft design is through correlations with in-situ test measurements, most often the SPT N-value or CPT/CPTu cone resistance. Correlations are convenient to implement in a spreadsheet for evaluation of friction angle as a function of depth within granular deposits.

Table 3-3 presents baseline relationships for evaluating the drained friction angle of cohesionless soils. This table is based on data for relatively clean sands. Considering this, selected values of  $\phi'$  based on SPT N-values should be reduced by  $5^\circ$  for clayey sands and the value from the table should be increased by  $5^\circ$  for gravelly sands.

GEC No. 5 (Sabatini et al., 2002) also presents the following correlations relating N-values to drained friction angle of sands.

$$\phi' = \sqrt{15.4(N_1)_{60}} + 20^\circ \quad 3-6$$

**TABLE 3-3 RELATIONSHIP BETWEEN RELATIVE DENSITY, SPT N-VALUE, AND DRAINED FRICTION ANGLE OF COHESIONLESS SOILS (SABATINI ET AL., 2002, AFTER MEYERHOF, 1956)**

State of Packing	Relative Density (%)	Standard Penetration Resistance, N (blows per ft)	Friction Angle, $\phi'$ (degrees)
Very Loose	< 20	< 4	< 30
Loose	20 – 40	4 – 10	30 – 35
Compact	40 – 60	10 – 30	35 – 40
Dense	60 – 80	30 – 50	40 – 45
Very Dense	> 80	> 50	> 45

Note:  $N = 15 + (N' - 15) / 2$  for  $N' > 15$  in saturated or very fine silty sand, where  $N'$  = measured blow count and  $N$  = blow count corrected for dynamic pore pressure effects during the SPT

$$\phi' = \tan^{-1} \left[ \frac{N_{60}}{12.2 + 20.3 \left( \frac{\sigma'_{vo}}{p_a} \right)} \right]^{0.34} \quad 3-7$$

In which:  $\phi'$  = effective stress friction angle,  $\sigma'_{vo}$  = vertical effective stress at the depth of N-value measurement, and  $p_a$  = atmospheric pressure in the same units as  $\sigma'_{vo}$  (e.g., 2,116 psf). Equation 3-6 is a derived correlation between  $\phi'$  and normalized SPT resistance,  $(N_1)_{60}$ , where high quality undisturbed frozen samples of natural sands were obtained that permitted direct measurements of  $\phi'$  in triaxial cells (Hatanaka and Uchida, 1996). Equation 3-7 is a well-known correlation between  $N_{60}$  and  $\phi'$  developed by Schmertmann (1975). Results from Equation 3-7 tend to be somewhat conservative, especially for shallow depths (i.e., less than 6 ft).

Kulhawy and Chen (2007) evaluated data compiled from the literature on the strength properties of very coarse-grained soils, including both sands and gravels. The database was used to develop the following correlation, based on regression analysis, between  $\phi'$  and N-value. This equation provides a first-order estimate of  $\phi'$  for a wide range of cohesionless soils and over a wide range of N-values, including values up to 100. Equation 3-8 is the recommended correlation for estimating  $\phi'$  for the purpose of evaluating unit side resistance of drilled shafts in cohesionless soils by the methods described in Chapter 13.

$$\phi' = 27.5 + 9.2 \log [(N_1)_{60}] \quad (r^2 = 0.356, n = 57) \quad 3-8$$

Where  $r^2$  = coefficient of determination and  $n$  = number of data pairs used in the regression analysis. AASHTO (2007) states that other in-situ tests, including CPT, may be used to determine  $\phi'$  and refers to GEC No. 5 (Sabatini et al., 2002) for details. The correlation given in GEC No. 5, based on CPT cone resistance,  $q_c$ , is given by:

$$\phi' = \tan^{-1} \left[ 0.1 + 0.38 \log \left( \frac{q_c}{\sigma'_{vo}} \right) \right] \quad 3-9$$

In which  $\sigma'_{vo}$  = vertical effective stress at the depth of the  $q_c$  measurement.



The presence of cobbles and boulders can result in erroneously high estimates of soil friction angle because SPT blow counts may be high when the soil particle sizes are large relative to the diameter of the standard split spoon sampler. Figure 3-5 provides a means to estimate  $\phi'$  of rockfill materials, which can be taken as a reasonable approximation for soil layers with cobble and boulder size particles. The figure shows typical ranges of secant values of  $\phi'$  for rockfills, gravels, and sands over a wide range of confining stresses and with initial porosities ranging from 0.17 to 0.48. The figure is recommended for estimating friction angle of soils with cobbles and boulders (not sands and gravels), based on the assumption that cobbles and boulders have friction angles similar to rockfill. The relevant curves are those corresponding to the solid lines labeled A through E. The appropriate curve is determined on the basis of particle compressive strength, which determines the rockfill grade, as presented in Table 3-4. The value of  $\phi'$  obtained from the figure is applicable only for field conditions subject to similar normal stress values. Selecting a representative value of  $\phi'$  to be used for calculation of drilled shaft side resistance requires the designer to calculate the variation in vertical effective stress between the top and bottom of the soil layer, then select an appropriate value of  $\phi'$  from Figure 3-5 for the calculated stress range.

**TABLE 3-4 UNCONFINED COMPRESSIVE STRENGTH OF PARTICLES FOR ROCKFILL GRADES SHOWN IN FIGURE 3-5**

Rockfill Grade	Particle Unconfined Compressive Strength (ksi)
A	$\geq 32$
B	24 – 32
C	18 – 24
D	12 -18
E	$\leq 12$

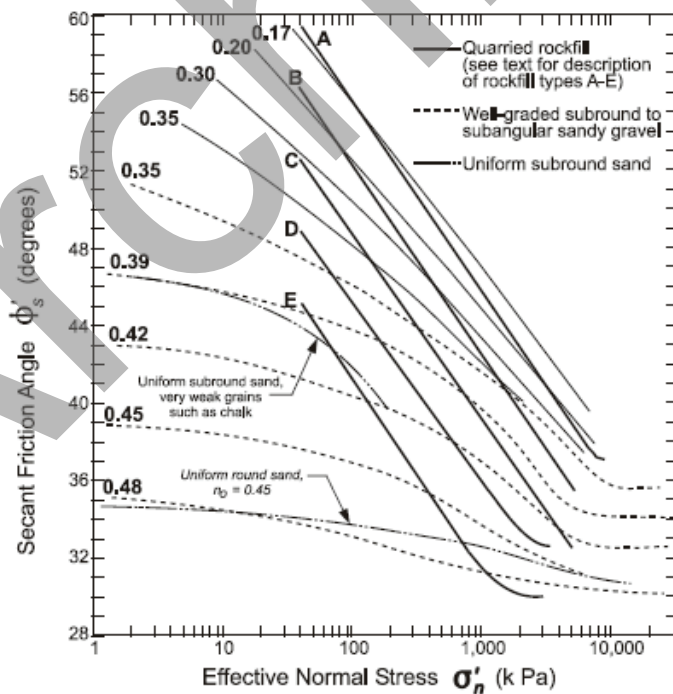


Figure 3-5 Typical Ranges of Friction Angle for Rockfills, Gravels, and Sands (Note: 1 kPa = 0.145 psi) (Terzaghi, Peck, and Mesri, 1996)

### 3.2.2.2 Fully-Drained Shear Strength of Fine-Grained Cohesive Soils

Under long-term or fully-drained loading conditions, drilled shafts deriving their resistance from cohesive soils can be analyzed using effective stress methods (Chapter 13). It should be noted, however, that no specific design equations for drilled shaft resistances are provided in AASHTO (2007) for this case and no resistance factors have been established for methods based on effective stress strength properties of cohesive soils. There may be situations, however, where a designer may wish to conduct a check on the strength limit state considering the long-term resistances of drilled shafts in heavily overconsolidated cohesive soils. In this case, the effective stress strength properties  $c'$  and  $\phi'$  are needed. The recommended method for measurement is to conduct laboratory strength tests on undisturbed samples obtained from Shelby tube or other appropriate sampling devices. The following tests are recommended in AASHTO (2007) for the drained strength of cohesive soils: consolidated drained direct shear tests, consolidated undrained triaxial compression tests with pore water pressure measurements (CU-bar), and consolidated drained (CD) triaxial compression tests. The CU-bar test has the advantages of requiring less time to complete and provides data for determination of both drained and undrained strength properties.

For long-term analyses involving cohesive soils, careful consideration should be given to use of a non-zero value of effective stress cohesion. GEC No. 5 recommends it is best to adopt  $c' = 0$  unless extensive laboratory testing or sufficient experience demonstrates the existence of bonding or cementation. Soil disturbance caused by drilled shaft construction can eliminate the cohesion component of strength at the soil-shaft interface, making it prudent to assume  $c' = 0$  for design purposes.

For preliminary analyses only, GEC No. 5 (Sabatini et al., 2002) presents the relationship shown in Figure 3-6 as a means to approximate the effective stress friction angle of clays from plasticity index.

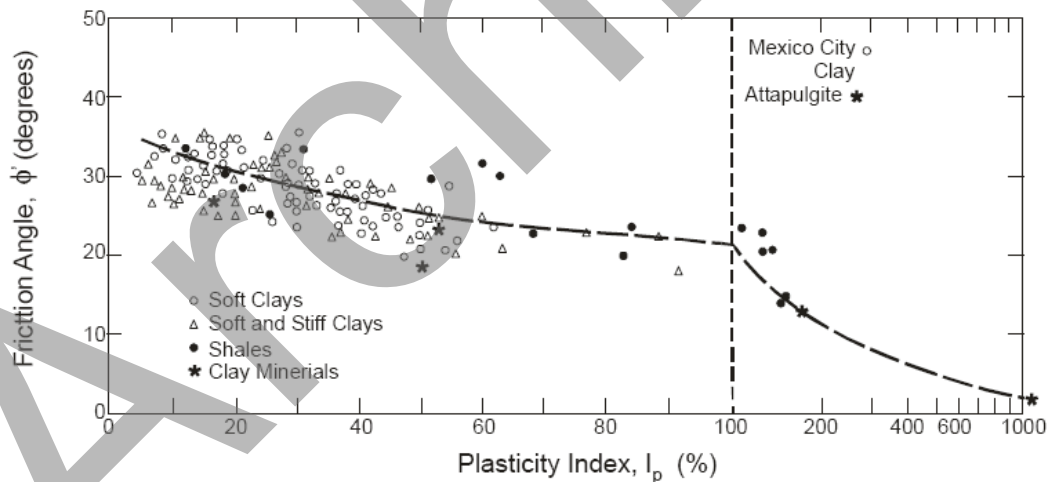


Figure 3-6 Relationship Between  $\phi'$  and PI of Clay Soils (Terzaghi, Peck, and Mesri, 1996)

### 3.2.2.3 Undrained Shear Strength of Fine-Grained Soils

Whenever possible, laboratory strength testing of undisturbed samples is the recommended method for measurement of undrained shear strength,  $s_u$ . In-situ testing can be used to assess  $s_u$  at sites where collection of undisturbed samples is difficult, but when in-situ tests are used it is strongly recommended that the results be calibrated against laboratory tests.

Laboratory strength tests for measurement of  $s_u$  include the unconfined compression (UC) test, unconsolidated undrained (UU) triaxial compression, and consolidated undrained (CU) triaxial compression. Although simpler to perform, the UC and UU tests are not as reliable measures of  $s_u$  as CU triaxial tests. Effects of sample disturbance, high strain rate, and uncertain drainage conditions in UC and UU tests can provide misleading, but usually conservative (lower), values of undrained strength. The CU test is superior because the sample can be reconsolidated to the original in-situ state of stress, providing an undrained strength more representative of in-situ conditions. CU triaxial tests on undisturbed samples of clay soils provide the highest-quality measurements of  $s_u$  for drilled shaft design. Both AASHTO (2007) and GEC No. 5 (Sabatini et al. 2002) recommend the use of CU triaxial compression tests over UC or UU tests for determination of  $s_u$ , while recognizing that typical transportation project practice entails the use of both CU and UU testing, and for cases where undisturbed sampling is difficult, vane shear testing (VST). AASHTO (2007) states that other in-situ tests can also be used. Table 3-5 is a partial listing of in-situ test methods most commonly used for drilled shafts and common approaches of estimating  $s_u$  from each test.

The following additional factors are taken into account when evaluating  $s_u$  from the in-situ tests listed in Table 3-5. The vane shear test (VST) is used to evaluate  $s_u$  of soft to stiff clay soils. The value of  $s_u$  is determined from the torque (T) required to rotate the vane and the diameter (D) of the vane, for the case where the height to diameter ratio (H/D) is two. Both peak and residual strengths are determined, allowing the sensitivity ( $S_t$ ) to be computed. The value of  $s_u$  determined from the VST requires correction for strain rate and soil anisotropy. The widely used correlation originally given by Bjerrum (1972) and listed in Table 3-5 relates the correction factor ( $\mu$ ) to soil plasticity index (PI). This correction factor is limited to an upper bound value of 1.1. The empirical correction factor  $f_1$  given in Table 3-5 for the SPT correlation can be interpolated for PI values between 15 and 50, but should be limited to the values given when PI values fall outside of the range presented.

The cone penetration test (CPT) should, in theory, provide a means to measure the undrained shear strength of fine-grained soils. If the cone is considered a model pile that fails the soil in a bearing capacity mode, the cone tip resistance ( $q_c$ ) can be related to undrained shear strength by:

$$q_c = N_k s_u + \sigma_{vo} \quad 3-10$$

where:  $N_k$  = cone bearing factor and  $\sigma_{vo}$  = total overburden stress at the test depth. Equation 3-10 leads to the expression for  $s_u$  given in Table 3-5. Theoretical methods to quantify  $N_k$  are reported by numerous researchers based on bearing capacity theory and cavity expansion theory. Additionally,  $N_k$  has been correlated to measured values of  $s_u$  using laboratory tests and other in-situ tests such as VST. For the practitioner, this has resulted in widely-varying recommendations that may be limited to a certain model of cone and a specific soil deposit. There is no general equation relating CPT results directly to undrained

**TABLE 3-5 COMMON IN-SITU TESTS USED FOR INTERPRETATION OF  $S_u$**

In-Situ Test	Conventional Interpretation of $s_u$	Comments
VST	$s_u = \frac{6T}{7\pi(D)^3}$ for H/D = 2	Static equilibrium analysis $\mu \approx 2.5(PI)^{-0.3} \leq 1.1$
CPT	$s_u = \frac{q_c - \sigma_{vo}}{N_k}$	$N_k$ based on bearing capacity theory, cavity expansion theory, or correlation
SPT	$s_{u(N_{60})} = \frac{f_1 N_{60} p_a}{100}$	Empirical: $f_1 = 4.5$ for PI = 50 Empirical: $f_1 = 5.5$ for PI = 15

shear strength, but Equation 3-10 provides a framework for developing local correlations based on regional soil conditions and observed behavior from laboratory tests. Values of  $N_k$  reported in the literature tend to vary between 10 and 20 and some practicing engineers have adopted a value of 15; however the value for a particular soil deposit can be significantly higher or lower. The recommended approach is to determine  $N_k$  empirically by calibrating CPT measurements with known measured values of  $s_u$ , for example from laboratory strength tests, preferably CU triaxial compression.

The following basic principles relate to the selection of  $s_u$  for foundation design, as summarized in GEC No. 5:

- Strength measurements from hand torvanes, pocket penetrometers, or unconfined compression tests should not be used solely to evaluate undrained shear strength for design analyses. Consolidated undrained triaxial tests and in-situ tests should be used.
- All available undrained strength data should be plotted with depth. The type of test used to evaluate each undrained strength should be identified clearly. Known soil layering should be used so that trends in undrained strength data can be developed for each soil layer.
- Review data summaries for each laboratory strength test method. Moisture contents of specimens for strength testing should be compared to moisture contents of other samples at similar depths. Significant changes in moisture content will affect measured undrained strengths. Review Atterberg limits, grain size, and unit weight measurements to confirm soil layering.
- CU tests on normally to lightly overconsolidated samples that exhibit disturbance should contain at least one specimen consolidated to at least 4 times preconsolidation stress ( $\sigma'_p$ ) to permit extrapolation of the undrained shear strength at  $\sigma'_p$ .
- Undrained strengths from CU tests correspond to the effective consolidation pressure used in the test. This effective stress needs to be converted to the equivalent depth in the ground.
- A profile of  $\sigma'_p$  (or overconsolidation ratio, OCR) should be developed and used in evaluating undrained shear strength.
- Correlations for  $s_u$  based on in-situ test measurements (*i.e.*, those based on Table 3-5) should not be used for final design unless they have been calibrated to the specific soil profile under consideration.

A plot of an undrained strength profile should be developed with  $s_u$  on the x-axis and depth on the y-axis. Laboratory test data including CU and UU testing should be plotted at the correct depths. Typically, CU strengths will be greater than UU strengths, and this should be used to judge the quality of the data. In-situ test data, which has been correlated to undrained strength, should be plotted at the depth where the measurement was taken. For strengths developed based on CPT, for which numerous measurements may have been taken, the data should be plotted as points without connecting the data with lines. This will facilitate visual identification of upper and lower bounds and anomalous data.

### 3.2.3 Deformation Properties

Deformation properties of soil may be needed in calculations used to evaluate the load-deformation response of drilled shafts under both lateral and axial loading. In Chapter 12, the primary method of analysis for shafts under lateral loading involves the use of  $p$ - $y$  curves. Some of the procedures for developing  $p$ - $y$  curves are based on stress-strain properties of the soil, for example, knowledge of the soil modulus, or the strain corresponding to one-half of the failure stress. Alternative methods of analysis

presented in Chapter 12, in particular those based on elastic continuum models, also require knowledge of soil modulus. In Chapter 13, the primary method of predicting axial load-settlement response of drilled shafts, based on normalized load-settlement curves from load tests, does not require knowledge of soil deformation properties. However, alternative and advanced analysis methods, described in Appendix D, require soil modulus as input.

An idealized stress-strain curve for soil is illustrated in Figure 3-7, in terms of deviatoric stress, defined as the difference between the major and minor principal stresses, and axial strain. This type of curve would be obtained, for example, from a laboratory triaxial compression test. Because stress-strain curves for soil typically are nonlinear, there is no unique value of modulus, defined as the slope of the stress-strain curve. For practical applications, the soil modulus ( $E_s$ ) can be defined as a secant modulus, which is the slope of a straight line extending through the origin to a selected point on the curve. For example, it is typical to select a secant modulus corresponding to a stress value that is one-half of the peak or maximum deviatoric stress, as illustrated in the figure. In this case, the modulus is denoted as the “50% secant modulus” or  $E_{50}$ , and the strain corresponding to one-half the maximum stress is denoted by  $\epsilon_{50}$ .

In addition to soil modulus, other deformation properties that may be required as input to load-deformation models include Poissons ratio,  $\nu$ , and shear modulus,  $G$ . According to elastic theory, these parameters are related by the relationship:

$$G = \frac{E}{2(1 + \nu)} \quad 3-11$$

Methods to determine elastic deformation properties of soils include: (1) laboratory tests on undisturbed samples, such as triaxial compression as described above, (2) in-situ tests, including pressuremeter (PMT) and dilatometer (DMT) in which some type of stress versus deformation measurement is made during conduct of the test, and (3) empirical correlations to soil type and/or in-situ tests such as SPT or CPT.

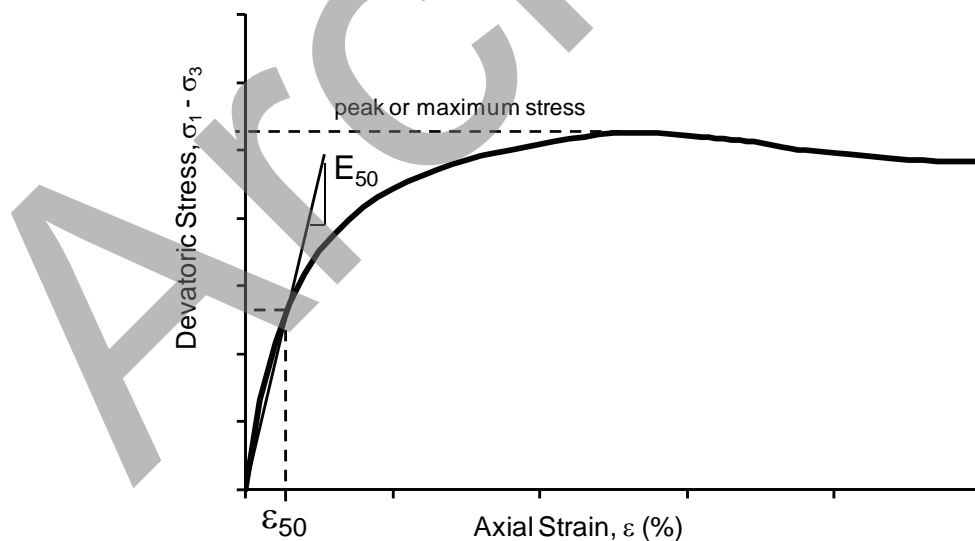


Figure 3-7 Example of Soil Stress-Strain Curve and 50% Secant Modulus

PMT and DMT provide evaluation of soil modulus through calibrated correlations between test measurements and data obtained through monitoring of full-scale structures. Detailed treatment of these methods is beyond the scope of this manual and the reader is referred to Mayne et al. (2001) for further information. It has not been common practice in the U.S. to conduct PMT and DMT testing for the purpose of obtaining soil deformation properties for drilled shafts, although methods have been proposed for developing  $p$ - $y$  curves directly from PMT measurements (Briaud, 1982), for use in lateral load analysis (Chapter 12).

AASHTO (2007) provides approximate values of equivalent soil modulus based on soil type and by correlation to SPT N-values and CPT cone resistance values, as given in Table 3-6. These values should be limited to preliminary analyses or cases in which it can be determined that service limit states do not govern design of the drill shaft.

Occasionally, additional information may be acquired to provide a clear understanding of soil deformation properties. For example, consolidation tests may be performed to compute the long-term settlement of drilled shafts or to determine the stress history in terms of preconsolidation stress ( $\sigma'_p$ ) and its effect on undrained shear strength. One-dimensional swell tests may be conducted for evaluating drilled shaft performance in expansive soils (covered further in Chapter 13). Soil modulus under dynamic or seismic loading conditions may be used in advanced modeling of soil-structure interaction under seismic loading. Properties of soil used to assess the potential for liquefaction and soil properties corresponding to a liquefied state are used to analyze drilled shafts for Extreme Event Limit State I, earthquake loading. This topic and the required soil properties are covered in Chapter 15.

### 3.2.4 Soil Erodibility

Bridge scour is the loss of soil by erosion due to flowing water around bridge supports. Design of bridge foundations under scour conditions requires that the depth of scour be evaluated. Also, different materials erode at different rates. Granular soils are eroded rapidly by flowing water, while cohesive or cemented soils are more scour-resistant. However, ultimate scour in cohesive or cemented soils can be as deep as scour in sand-bed streams.

A critical value of shear stress,  $\tau_c$ , exists, above which a soil will erode and below which no erosion occurs. The critical shear stress corresponds to a critical water flow velocity,  $v_c$ . In cohesionless soils (sands and gravels), the critical shear stress has been empirically related to the mean grain size,  $D_{50}$  (Briaud et al., 2001):

$$\tau_c \text{ (N/m}^2\text{)} = D_{50} \text{ (mm)} \quad (1 \text{ inch} = 25.4 \text{ mm, } 1 \text{ N/m}^2 = 0.00015 \text{ psi}) \quad 3-12$$

For such soils, the erosion rate beyond the critical shear stress is very rapid and one flood is long enough to reach the maximum scour depth. Therefore, there is a need to be able to predict the critical shear stress to know if there will be scour or no scour, but there is little need to define an erosion rate function beyond that point because the erosion rate is too high to warrant a time dependent analysis. In cohesive soils (silts, clays) and rocks, Equation 3-12 is not applicable and the erosion rate is sufficiently slow that a time rate analysis is warranted. Therefore it is necessary to establish a relationship between shear stress and erosion rate, referred to as the erosion function.

Briaud et al. (2001, 2003) describe the Erosion Function Apparatus, or EFA, which was developed to obtain the erosion function. Figure 3-8 shows a schematic of the EFA and the resulting erosion function. A soil sample is retrieved from the bridge site using an ASTM standard thin wall steel tube (Shelby tube), placing it through a tight fitting opening in the bottom of a rectangular cross section conduit, pushing a

small protrusion of soil in the conduit, flowing water over the top of the sample at a chosen velocity, and recording the corresponding erosion rate ( $z$ ). This is repeated for several velocities. A plot of erosion rate versus shear stress based on the test measurements is referred to as the measured erosion function, as illustrated in Figure 3-8.

For cohesionless soils, determination of  $D_{50}$  may be sufficient for evaluation of erosion potential. For cohesive soils, determination of the erosion function using the EFA is recommended. The EFA is also applicable to any soil type and rock. Additional information on soil erosion and its application to bridge foundations is given by Briaud (2008).

**TABLE 3-6 ELASTIC PROPERTIES OF SOILS (AFTER AASHTO 2007)**

<b>A. Soil Modulus Based on Soil Type</b>		
Soil Type	Typical Range of Young's Modulus, $E_s$ (ksf)	Poisson's Ratio, $\nu$
Clay:		
Soft sensitive	50 – 300	0.4 - 0.5 (undrained)
Medium stiff to stiff	300 – 1,000	
Very stiff	1,000 – 2,000	
Loess	300 – 1,200	0.1 – 0.3
Silt	40 – 400	0.3 – 0.35
Fine sand:		
Loose	160 – 240	0.25
Medium dense	240 – 400	
Dense	400 – 600	
Sand:		
Loose	200 – 600	0.20 – 0.36
Medium dense	600 – 1,000	0.30 – 0.40
Dense	1,000 – 1,600	
Gravel:		
Loose	600 – 1,600	0.20 – 0.35
Medium Dense	1,600 – 2,000	0.30 – 0.40
Dense	2,000 – 4,000	
<b>B. Estimating Soil Modulus (<math>E_s</math>) from SPT N-value</b>		
Soil Type	$E_s$ (ksf)	
Silts, sandy silts, slightly cohesive mixtures	8 $(N_1)_{60}$	
Clean fine to medium sands and slightly silty sands	14 $(N_1)_{60}$	
Coarse sands and sands with little gravel	20 $(N_1)_{60}$	
Sandy gravel and gravels	24 $(N_1)_{60}$	
<b>C. Estimating Soil Modulus (<math>E_s</math> in ksf) from Static Cone Resistance (<math>q_c</math>)</b>		
Sandy soils	$2 q_c$ (where $q_c$ is in ksf)	

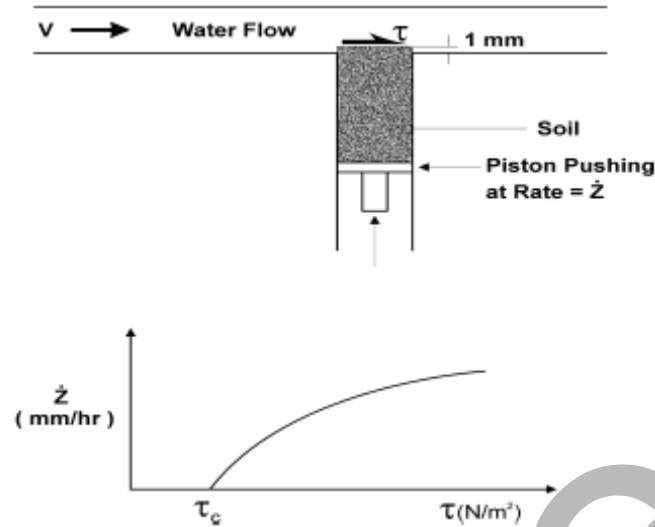


Figure 3-8 Erosion Function Apparatus and Measured Erosion Function (Briaud et al., 2003)  
 (Note: 1 inch = 25.4 mm, 1 N/m<sup>2</sup> = .00015 psi)

### 3.2.5 In-Situ State of Stress

The initial, or in-situ, state of stress in the ground is required in several of the design equations presented in Chapter 13. The in-situ state of stress is defined by the total and effective vertical and horizontal stresses, as well as the preconsolidation stress. Total vertical (overburden) stress is calculated as the cumulative sum of the total unit weights ( $\gamma_T$ ) with depth,  $\sigma_{vo} = \sum (\gamma_T) dz$ , summed from the ground surface

( $z = 0$ ) to the depth of interest. If the depth to the water table is designated  $z_w$  and the depth of interest is  $z$ , then  $u_o = \gamma_w(z-z_w)$ . The effective vertical stress is then calculated as:

$$\sigma'_{vo} = \sigma_{vo} - u_o \quad 3-13$$

Above the water table, the soil may be dry, partially saturated, or completely saturated due to capillarity effects. In the case of clean sands, it is often assumed that the soil is dry, and therefore, the dry unit weight of soil is used in stress calculations. Moreover, for a completely dry soil, the pore pressure is zero. Therefore, the total and effective overburden stresses are equal. In clays, capillary effects can result in complete saturation for heights of 30 feet or more above the water table and therefore  $\gamma_{sat}$  may be appropriate. A corresponding negative hydrostatic porewater pressure occurs above the phreatic surface (free water table) which is calculated by the relation:  $u_o = \gamma_w (z-z_w)$ . In this case of negative pore pressure, the effective vertical stress is larger than is the case of dry soil at the same depth.

The effective horizontal stress in the ground ( $\sigma'_{ho}$ ) is related to the vertical effective stress by the at-rest lateral earth pressure coefficient,  $K_o$ :

$$K_o = \frac{\sigma'_{ho}}{\sigma'_{vo}} \quad 3-14$$



In the absence of direct measurements, laboratory testing on a variety of soils using oedometer and triaxial specimens have shown that the magnitude of  $K_o$  depends strongly on the stress history and frictional characteristics of the deposit. For simple virgin loading-unloading of “normal soils” that are not cemented, the  $K_o$  value increases with overconsolidation ratio (OCR) according to (Mayne and Kulhawy, 1982):

$$K_o = (1 - \sin \phi') \text{OCR}^{\sin \phi'} \leq K_p \quad 3-15$$

$$\text{OCR} = \frac{\sigma'_p}{\sigma'_v} \quad 3-16$$

where  $\sigma'_p$  = effective vertical preconsolidation stress. In Equation 3-15,  $K_o$  is limited to an upper bound value equal to the Rankine coefficient of passive earth pressure,  $K_p$ . A variety of methods have been proposed for evaluation of either  $K_o$  or  $\sigma'_p$  by correlations with in-situ test measurements. For a practical estimate based on the most commonly used in-situ test (SPT) the following correlation is suggested by Mayne (2007):

$$\frac{\sigma'_p}{p_a} \approx 0.47 (N_{60})^m \quad 3-17$$

where  $m = 0.6$  for clean quartzitic sands and  $m = 0.8$  for silty sands to sandy silts (*e.g.*, Piedmont residual soils), and  $p_a$  = atmospheric pressure in the same units as  $\sigma'_p$ . Kulhawy and Chen (2007) suggest the following correlation provides a good fit for gravelly soils:

$$\frac{\sigma'_p}{p_a} = 0.15 N_{60} \quad 3-18$$

Studies involving field tests in these materials have shown generally good agreement with these correlations; however, additional factors such as cementation, aging, structuring, and desiccation may alter the magnitude of in-situ  $K_o$ . For more accurate assessments of in-situ horizontal stress, in-situ tests including PMT and DMT provide more direct measurements. Detailed evaluation of horizontal stress from these tests is given in Mayne et al. (2001).

### 3.2.6 Unsaturated Soil Properties

In classical soil mechanics theory, the shear strength of soils is described in terms of effective stress, and the soil parameters required for plastic equilibrium or limit equilibrium analyses are the effective cohesion  $c'$  and effective angle of friction,  $\phi'$ . These soil parameters are assumed to apply for two limiting conditions related to soil moisture and degree of saturation: when the soil is dry and when the soil is saturated. The Mohr-Coulomb strength criterion in terms of effective stress is given by:

$$\tau = c' + \sigma' \tan \phi' = c' + (\sigma_n - u_w) \tan \phi' \quad 3-19$$

where the normal effective stress  $\sigma'$  is equal to the difference between the total normal stress  $\sigma_n$  and the pore water pressure  $u_w$ . In traditional foundation engineering practice, soils below the water table are assumed to be saturated and the pore water pressure used in Equation 3-19 is calculated on the basis of

depth below the static water table and unit weight of water. Above the water table, the pore water pressure is taken equal to zero.

In reality, soils in the subsurface zone above the water table (vadose zone) may be partially saturated. The classical theories and formulations for saturated or dry soil behavior do not apply directly to the unsaturated soil region, because pore water pressures are negative due to capillary tension that exists at the air-water interface. Research, starting with Bishop et al. (1960), has led to a unified theory for evaluation of unsaturated soil behavior, including methods for measurement of shear strength, compressibility, and permeability of unsaturated soils (Fredlund and Rahardjo, 1993; Fredlund, 1997). However, the application of unsaturated soil mechanics to foundation engineering practice has not developed to the point of being considered routine. This can be attributed to the expense, time, and additional analyses required to measure unsaturated soil properties in laboratory tests. For example, measurement of shear strength in terms of effective stress requires evaluation of soil suction. This requires modification of the triaxial or direct shear device to allow for independent measurement of pore-air and pore-water pressures. Most state transportation agencies and commercial testing labs in the U.S. do not employ this type of equipment at the present time.

The approach recommended for drilled shaft engineering in partially saturated soils is as follows:

For cohesionless soils, the strength parameter required for resistance calculations is the effective stress friction angle,  $\phi'$ . The primary method for determination of  $\phi'$  is through correlation to in-situ test measurements, most commonly SPT N-values or CPT cone resistance values, as presented earlier in this chapter. The  $\phi'$  value thus determined is assumed to be affected by partial saturation existing in-situ at the time of the test, and in this way the effects of partial saturation are taken into account indirectly. In the methods given in later chapters for evaluation of drilled shaft lateral, side, and tip resistances for cohesionless soils, effective stresses are evaluated in terms of total stress and pore water pressure. The pore water pressure above the water table is assumed to be zero. This is a conservative assumption, because any negative pore water pressure due to partial saturation above the water table increases the effective stress, thus increasing shear strength and resistance. Furthermore, in cohesionless soils with low fines content and therefore high permeability, the zone of negative pore water pressure above the water table is not significant. For drilled shaft design, in most cases, the lack of analytical methods that account explicitly for the state of effective stress under partially saturated conditions is either conservative or its effects are negligible.

In cohesive soils, the strength parameter used in equations for drilled shaft resistances is the undrained shear strength,  $s_u$ , which is a strength parameter interpreted only within the context of total stress with  $\phi = 0$ . The approach described previously for selecting values of  $s_u$  for drilled shaft design can be applied in a manner that accounts for the effects of partial saturation. Specifically, the primary recommended method for determination of  $s_u$  is by laboratory CU triaxial compression tests on undisturbed samples of the cohesive soil at consolidation cell pressures corresponding to the effective overburden stress at the depth at which resistance is being calculated. *The CU tests should be conducted at the natural in-situ water content of the undisturbed sample.* In this way, the effect of partial saturation and the corresponding negative pore water pressure are reflected in the value of  $s_u$  measured by the test. The same concept and approach applies if UU triaxial tests are conducted.

For sites where the undrained shear strength of cohesive soils is evaluated by in-situ tests (Table 3-5), effects of partial saturation and negative pore water pressure are taken into account indirectly, in the sense that the measured test parameter is affected by the partially saturated, undrained strength of the soil. One of the advantages of in-situ testing is that the measured response represents the actual strength and stiffness of the soil for the in-situ condition, which includes partial saturation. When interpreted within

the context of total stress (*i.e.*,  $\phi = 0$ ), all of the in-situ conditions that affect the soil strength are incorporated into the single strength parameter,  $s_u$ .

It was recommended above that all available measurements of  $s_u$  of cohesive soils be plotted as a function of depth, and that this be done for each cohesive soil layer. It was further recommended that in-situ moisture contents be plotted versus depth for the same soil layers. This approach allows evaluation of undrained shear strength as a function of both depth and moisture content. If the water table is expected to change over the design life of the structure, this enables the designer to account for the effects of a higher water table on soil strength, and therefore on drilled shaft resistances calculated on the basis of undrained shear strength.

### 3.3 PROPERTIES OF ROCK

For engineering problems in rock, it is important to distinguish between *intact rock* and *rock mass*. Intact rock refers to the consolidated and cemented assemblage of mineral particles forming the rock material, excluding the effects of macro-scale discontinuities such as joints, bedding planes, minor faults, or other recurrent planar features. The term rock mass is used to describe the system comprised of intact rock and discontinuities. Characteristics of intact rock are determined from index and laboratory tests on core specimens. Properties of rock mass may be estimated on the basis of intact rock properties plus characteristics of discontinuities. Some rock mass properties may be measured using in-situ tests. Some of the design methods given in this manual are based on properties of intact rock; for example, correlations between nominal unit side resistance and uniaxial compressive strength. However, analytical treatment of load-settlement response requires knowledge of the rock mass modulus.

The information presented in this section applies to materials defined either as rock or cohesive intermediate geomaterials (cohesive IGM). Cohesive IGM is defined as material that exhibits unconfined compressive strengths in the range of  $10 \text{ ksf} \leq q_u \leq 100 \text{ ksf}$ . Specific materials identified by O'Neill et al. (1996) as being cohesive IGM's include (1) argillaceous geomaterials such as heavily overconsolidated clays, clay shales, saprolites, and mudstones that are prone to smearing when drilled, and (2) calcareous rocks such as limestone and limerock and argillaceous geomaterials that are not prone to smearing when drilled.

#### 3.3.1 Index Properties of Rock

Index properties of rock mass required for the design of drilled shafts include the description of rock core based on visual and physical examination, as summarized in Chapter 2. The descriptions of rock material, discontinuities, infilling, and other characteristics should be noted on forms such as the example given in Figures 2-8 and 2-9. Rock quality designation (RQD), also described in Chapter 2, is a required index property for drilled shafts. Further evaluation of the above parameters can be conducted on core samples in the laboratory in order to supplement the data recorded in the field at the time of drilling.

The slake durability test (ASTM D 4644) provides an index for identifying rocks that will weather and degrade rapidly. The test is appropriate for any weak rock but is a particularly useful index for argillaceous sedimentary rocks (mudstone, shale, clay-shales). Many of these rocks will fall into the category of cohesive IGM as defined above. Representative rock fragments are placed in a wire mesh drum and dried in an oven to constant weight. The drum is partially submerged in water and rotated at 20 revolutions per minute for a period of 10 minutes. The drum and its contents are then dried a second time and the loss of weight is recorded. The test cycle is repeated a second time and the slake durability index,  $I_D$ , is calculated as the ratio (reported as a percent) of final to initial dry weights of the sample. Rocks with  $I_D$  less than 60 are considered prone to rapid degradation and may indicate a susceptibility to

degradation of the borehole wall when water is introduced during drilled shaft excavation, potentially leading to formation of a "smear zone". Some argillaceous rocks will degrade and form a smear zone when exposed to atmospheric conditions, even in the absence of exposure to drilling water. Hassan and O'Neill (1997) define the smear zone as a layer of soil-like material along the socket wall, and demonstrate that smearing can have a significantly negative effect on side load transfer of shafts in argillaceous rock. When rock with  $I_D$  less than 60 has been identified, special construction and inspection methods may be required. A technique found to work in smear-prone argillaceous rock in the vicinity of Denver, CO, is to attach a grooving tool to the auger and make a final pass with the grooving tool-equipped auger prior to installation of the reinforcing cage, followed by prompt placement of concrete. The objective is to scrape the softened material from the borehole walls and then to place the reinforcing cage and concrete before additional softening occurs. Inspection is required to verify that the specified procedures were carried out promptly and to verify that all softened material is removed from the sides and bottom of the hole.

### 3.3.2 Properties of Intact Rock

Properties of intact rock that are used most often for foundation engineering are uniaxial compressive strength ( $q_u$ ) and elastic modulus ( $E_R$ ). The compressive strength of intact rock is determined by applying a vertical compressive force to an unconfined cylindrical specimen prepared from rock core. The peak load is divided by the cross-sectional area of the specimen to obtain the uniaxial compressive strength ( $q_u$ ). The ASTM procedure (D 2938) specifies tolerances on smoothness over the specimen length, flatness of the ends, the degree to which specimen ends are perpendicular to the length, and length to diameter ratio. Elastic modulus of intact rock is determined during uniaxial compression testing by measuring deformation as a function of load. It is common to measure both axial and diametral deformation to determine elastic modulus and Poisson's ratio. Test procedures are given in the ASTM standard (D 3148) and discussed further by Wyllie (1999). It is important to note that the ASTM procedure defines several methods for determination of modulus, including tangent modulus at a specified stress level, average modulus over the linear portion of the stress-strain curve, and secant modulus at a fixed percentage of maximum strength. For rocks that exhibit nonlinear stress-strain behavior, these methods may provide significantly different values of modulus and it is important to note which method was used when reporting the results.

The point load test is conducted by compressing a core sample or irregular piece of rock between hardened steel cones, causing failure by the development of tensile cracks parallel to the axis of loading. The uncorrected point load strength index is given by:

$$I_s = P/D^2 \quad 3-20$$

where  $P$  = load at rupture, and  $D$  is the distance between the point loads. The *point load index* is reported as the point load strength of a 50-mm (or 1.97 inch) diameter core. For other specimen sizes a correction factor is applied to determine the equivalent strength of a 50-mm specimen. The point load index is correlated to uniaxial compressive strength by:

$$q_u = C I_{s(50)} \quad 3-21$$

where  $q_u$  is the unconfined compressive strength,  $I_{s(50)}$  is the point load strength corrected to a diameter of 50 mm, and  $C$  is a correlation factor that should be established on a site-specific basis by conducting a limited number of uniaxial compression tests on prepared core samples. If a site-specific value of  $C$  is not available, the ASTM Standard recommends approximate values based on core diameter. For a 54-mm (or 2.1 inch) diameter core (NX core size), the recommended value of  $C$  is 24. The principal advantages of

the point load test are that it can be carried out quickly and inexpensively in the field at the site of drilling and that tests can be conducted on irregular specimens without the preparation required for uniaxial compression tests. A disadvantage is the wide range of results that is usually obtained, making it difficult to select a representative correction factor,  $C$ .

### 3.3.3 Strength of Rock Discontinuities

Direct shear testing is applicable to determination of the Mohr-Coulomb shear strength parameters cohesion,  $c$ , and friction angle,  $\phi$ , of discontinuity surfaces in rock (ASTM D 5607). Although lab testing of discontinuities is not routine for foundation studies, shear strength of discontinuities may govern capacity in certain conditions, for example, base capacity of socketed foundations when one or two intersecting joint sets are oriented at an intermediate angle to horizontal. The direct shear apparatus is set up so that the discontinuity surface lies in the plane of shearing between the two halves of the split box. Both peak and residual values of the strength parameters ( $c'$  and  $\phi'$ ) are determined (Wyllie and Norrish 1996).

The other notable application of this test is in simulating the shear strength at the rock-concrete interface for evaluation of side resistance of socketed shafts. However, for this application, the constant normal stiffness (CNS) direct shear test described by Johnston et al. (1987) is more applicable. Normal force is applied through a spring that increases or decreases the applied force in proportion to the magnitude of normal displacement (dilation). Dilatancy of the interface is a major factor controlling strength and stiffness of socketed shafts under axial load. Standard and CNS direct shear testing of rock-concrete interfaces are not routine procedures in U.S. practice and there are no design methods in AASHTO (2007) based on these tests. Direct shear testing is presented here as an alternative approach to characterizing the side resistance of rock sockets for the interested user, but would require calibration of resistance factors based on load testing and local practice.

### 3.3.4 In-Situ Tests for Rock

In-situ testing can be used to evaluate rock mass deformation modulus and, in some instances, rock mass strength. In-situ testing methods with applications to rock socket design are presented in Table 3-7. Use of the in-situ tests in Table 3-7 is not considered routine for design of drilled shafts, but a recent survey of transportation agencies (Turner 2006) showed that several use the pressuremeter test (PMT) for measuring rock mass modulus for establishing  $p$ - $y$  curves, and recent research on this topic has shown promise for future applications (Gabr et al., 2002; Yang, 2006). Note that the term rock dilatometer is used to describe a pressuremeter intended for use in rock but should not be confused with the flat plate dilatometer used for in-situ testing of soil. Information on procedures and interpretation of the tests identified in Table 3-7 and other in-situ tests for rock are given in the relevant ASTM standards (see Table 3-7), *Rock Testing Handbook* (1993), and Mayne et al. (2001). A brief description of the PMT and Texas Cone Penetration Test (TCPT) and their use in drilled shaft design is provided below.

The pressuremeter used in rock is similar to the device used in soil (Figure 3-1), but with a stiffer membrane and a higher pressure range. Commercially available pressuremeter devices for rock are currently limited to maximum pressures of around 7 ksi (approximately 50 MPa). At each testing depth, a uniform radial pressure is exerted on the walls of the drill hole by means of a flexible rubber sleeve. Volumetric expansion of the borehole can be measured by the inflation medium (generally oil or water) as the pressure is raised, or by electronic transducers that measure radial displacement of the inside of the sleeve. For the latter type, the measurement devices are generally arranged at right angles, enabling the anisotropy of the rock to be evaluated. The expansion volume (dilation) of the borehole can be measured with a calibrated hand-operated screw pump, in terms of the number of pump turns ( $n$ ). Alternatively, the volumetric expansion can be measured directly in the probe.

**TABLE 3-7 IN-SITU TESTS RELEVANT TO SHAFTS IN ROCK**

<b>Method</b>	<b>Procedure</b>	<b>Rock Properties</b>	<b>Limitations/Remarks</b>
Pressuremeter (includes devices referred to as rock dilatometer)	Pressuremeter is lowered to the test elevation in a prebored hole; flexible membrane of probe is expanded exerting a uniform pressure on the sidewalls of the borehole	Rock mass modulus; rock mass strength in weak rocks ASTM D 4719	Test affects a small area of rock mass; depending on joint spacing, may or may not represent mass behavior; limited to soft or weak rocks
Borehole Jack	Jacks exert a unidirectional pressure to the walls of a borehole by means of two opposed curved steel platens	Rock mass modulus; rock mass strength in weak rocks ASTM D 4971	Measured modulus value must be corrected to account for stiffness of steel platens; test method can be used to provide an estimate of anisotropy
Texas Cone Penetration Test	Steel cone is driven by a drop hammer; number of blows per 300 mm of penetration is TCPT <i>N</i> -value; depth of penetration per 100 blows is penetration resistance ( <i>PR</i> )	Correlated to compressive strength of weak rocks encountered in Texas and Oklahoma	Limitations similar to those of Standard Penetration Test; currently used by TX and OK DOT's for direct correlation to side and base resistance of shafts in weak rock

Adapted from: GEC No. 5 (Sabatini et al., 2002)

Because of the generally stiff character of most rock (even fractured rock), the hydraulic system should be relatively stiff and the system should be calibrated prior to and after testing. Figure 3-9 shows typical pressure-dilation graphs for a calibration test carried out in a material of known modulus; this figure also shows the result of a test carried out in rock. A complete test usually consists of three loading and unloading cycles, with dilation and pressure readings taken on both the loading and unloading cycles.

The shear modulus,  $G_m$ , and the deformation modulus of the rock mass,  $E_m$ , are determined from the pressuremeter curve by (ISRM 1987):

$$G_m = k_R \frac{\pi L d^2}{\rho} \quad 3-22$$

$$E_m = 2 (1 + \nu_r) G_m \quad 3-23$$

where  $L$  is the length of the cell membrane;  $d$  is the diameter of the drill hole;  $\nu_r$  is Poisson's ratio of the rock; and  $\rho$  is the pump constant defined as the fluid volume displaced per turn of the pump wheel. The stiffness of rock over the length of the cell membrane,  $k_R$ , is:

$$k_R = \frac{k_s k_T}{(k_s - k_T)} \quad 3-24$$

where  $k_s$  = stiffness of the hydraulic system and  $k_T$  = stiffness of overall system plus rock (ratio D/C in Figure 3-9).

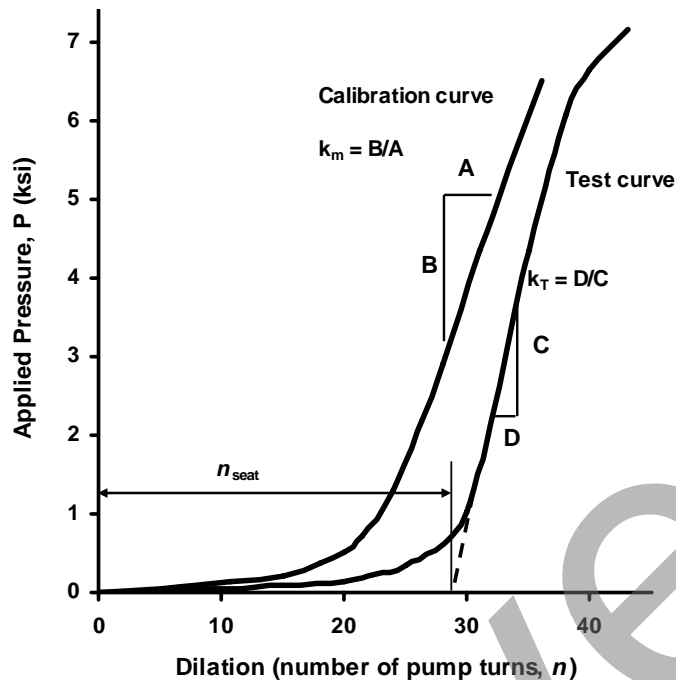


Figure 3-9 Typical Pressure-Dilation Graphs for a Pressuremeter Test in Rock (after ISRM 1987).

Several commercial versions of pressuremeter for rock testing are available and it is critical that the user is familiar with the calibration and operating requirements of the device being used (Wyllie 1999). Stiffness of the hydraulic system can be determined from the calibration test by rearranging Equation 3-24 and substituting the known stiffness of the test specimen ( $k_R$ ) and the measured stiffness of the overall system plus specimen,  $k_m$  ( $B/A$  in the figure), for  $k_T$ , to solve for the hydraulic system stiffness,  $k_s$ .

The deformation modulus,  $E_m$ , is the rock mass property from PMT testing that is most relevant to drilled shaft design. The modulus is used to develop  $p$ - $y$  curves for analysis of shafts under lateral loading (Chapter 12) and for analysis of axial load-displacement response (Appendix D). In cases of weak rock where a yield pressure can be achieved, the test may also provide a means to determine rock mass strength. For example, Colorado DOT uses PMT measurements for estimating the compressive strength of weak claystone as described in greater detail in Appendix B.

The Texas Cone Penetration Test (TCPT) consists of a 3-inch diameter solid steel cone driven by a 170 lb drop hammer. The Texas and Oklahoma DOT's use empirical correlations between the TCPT parameters and drilled shaft side and base resistances in soil and soft rock. The test procedure and correlations are available in the Texas DOT Geotechnical Manual, available online (Texas DOT 2005). Some researchers have developed empirical correlations between TCPT measurements and properties of soft rock. For example, Cavusoglu et al. (2004) show correlations between compressive strength of upper Cretaceous formation clay shales (UU triaxial tests) and limestone (uniaxial compression) and penetration resistance ( $PR$ ) measurements conducted for Texas DOT projects. These materials are defined as cohesive IGM's. The correlations, presented in Appendix B, are highly formation-dependent and exhibit a high degree of scatter, but provide first order estimates of rock strength based on TCPT resistance in formations where sample recovery is otherwise difficult.

Some agencies use the SPT in soft or weak rock to obtain rock properties (unconfined compressive strength) or for correlating SPT  $N$ -values directly to shaft resistances. For example, the "Colorado SPT-

Based Method” is used to establish design values of both unit side resistance and base resistance for shafts socketed into claystones when the material cannot be sampled in a way that provides intact core specimens adequate for laboratory compression tests (Abu-Hejleh et al. 2003). Some states (*e.g.*, Florida) utilize a small-scale pullout test on a concrete plug to determine unit side resistance of shafts in soft rock. Both the Colorado and Florida approaches are described in Appendix B.

### 3.3.5 Rock Mass Classification

Several empirical classification systems have been proposed for rating of rock mass behavior. The system recommended in the current AASHTO LRFD Bridge Design Specifications (2007) is the Geomechanics Classification developed by Bieniawski (1989), in which a rock mass is classified in terms of its Rock Mass Rating (RMR). For foundations in rock, correlations were developed between RMR and rock mass strength and deformation properties. To better facilitate correlations between rock mass characteristics and engineering properties, Hoek et al. (1995) introduced the Geological Strength Index (GSI) and this index should be used in place of RMR. Initially, correlations were developed to convert RMR to GSI, which was then used to estimate rock mass properties. More recently, Marinos and Hoek (2000) developed charts for direct determination of GSI based on description of rock mass from core or other exposures. As stated by Marinos and Hoek (2000):

“The GSI Index is based upon an assessment of the lithology, structure and condition of discontinuity surfaces in the rock mass and it is estimated from visual examination of the rock mass exposed in surface excavations such as roadcuts, in tunnel faces and in borehole core. . . . The Geological Strength Index, by the combination of the two fundamental parameters of geological process, the blockiness of the mass and the condition of the discontinuities, respects the main geological constraints that govern a formation and is thus both a geologically friendly index and practical to assess.”

Figure 3-10 shows the chart for direct determination of GSI from rock core or exposures of rock mass in roadcuts or other exposures. GSI is estimated on the basis of two parameters: (1) structure of the rock mass, and (2) condition of rock surfaces. In combination with rock type (lithology) and uniaxial compressive strength of intact rock ( $q_u$ ), GSI provides a practical means to assess rock mass strength and rock mass modulus for foundation design, as described in Section 3.3.6.1 below. Marinos and Hoek (2000) present additional charts showing expected ranges of GSI for specific rock types, which should be consulted. The use of GSI is only applicable to rock masses whose behavior is controlled by the overall mass response and not by failure along pre-existing structural discontinuities. This generally applies to either relatively intact rock mass or to highly fractured rock mass that can be characterized by the descriptive terms shown in Figure 3-10 (*e.g.*, “blocky”, “disintegrated”, etc.). If shear failure can occur along discontinuities (“structurally controlled failure”) the shear strength along these planar features must be evaluated, for example by direct shear testing as described in Section 3.3.3. Additional discussion of GSI and its application to determination of rock mass engineering properties is presented in the following section.



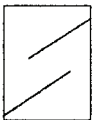
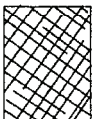




<p><b>GEOLOGICAL STRENGTH INDEX FOR JOINTED ROCKS (Hoek and Marinos, 2000)</b></p> <p>From the lithology, structure and surface conditions of the discontinuities, estimate the average value of GSI. Do not try to be too precise. Quoting a range from 33 to 37 is more realistic than stating that GSI = 35. <u>Note that the table does not apply to structurally controlled failures.</u> Where weak planar structural planes are present in an unfavourable orientation with respect to the excavation face, these will dominate the rock mass behaviour. The shear strength of surfaces in rocks that are prone to deterioration as a result of changes in moisture content will be reduced if water is present. When working with rocks in the fair to very poor categories, a shift to the right may be made for wet conditions. Water pressure is dealt with by effective stress analysis.</p>		SURFACE CONDITIONS				
		<p><b>VERY GOOD</b> Very rough, fresh unweathered surfaces</p>	<p><b>GOOD</b> Rough, slightly weathered, iron stained surfaces</p>	<p><b>FAIR</b> Smooth, moderately weathered and altered surfaces</p>	<p><b>POOR</b> Slacksided, highly weathered surfaces with compact coatings or fillings or angular fragments</p>	<p><b>VERY POOR</b> Slacksided, highly weathered surfaces with soft clay coatings or fillings</p>
STRUCTURE		DECREASING SURFACE QUALITY →				
 <p><b>INTACT OR MASSIVE</b> - intact rock specimens or massive in situ rock with few widely spaced discontinuities</p>	90			N/A	N/A	
 <p><b>BLOCKY</b> - well interlocked undisturbed rock mass consisting of cubical blocks formed by three intersecting discontinuity sets</p>	80	70				
 <p><b>VERY BLOCKY</b>- interlocked, partially disturbed mass with multi-faceted angular blocks formed by 4 or more joint sets</p>		60	50			
 <p><b>BLOCKY/DISTURBED/SEAMY</b> - folded with angular blocks formed by many intersecting discontinuity sets. Persistence of bedding planes or schistosity</p>			40	30		
 <p><b>DISINTEGRATED</b> - poorly interlocked, heavily broken rock mass with mixture of angular and rounded rock pieces</p>				20		
 <p><b>LAMINATED/SHEARED</b> - Lack of blockiness due to close spacing of weak schistosity or shear planes</p>	N/A	N/A			10	

Figure 3-10 Chart for Determination of GSI for Jointed Rock Mass (Marinos and Hoek, 2000)

### 3.3.6 Engineering Properties of Rock Mass

#### 3.3.6.1 Strength

Geotechnical evaluation of foundation nominal resistance under axial and lateral loading is calculated on the basis of rock strength. The primary design equations presented in Chapters 12 and 13, and in AASHTO (2007), incorporate the uniaxial compressive strength of intact rock ( $q_u$ ) as a representative measure of rock strength and strength of cohesive IGM. Empirical adjustments are made to resistance equations in some cases to account for lower quality rock mass, and these are given in terms of RQD. Laboratory testing for measurement of  $q_u$  and correlations for  $q_u$  based on point load testing are described above in Section 3.3.2. In Article 10.8.3.5.4.c of AASHTO (2007), and in Chapter 13 of this manual, an equation is given for calculating the nominal tip resistance of drilled shafts in fractured rock mass based on a lower-bound solution to the bearing capacity equation. This method requires quantitative assessment of rock mass strength incorporating the effects of discontinuities in addition to strength of the intact rock. Specifically, the design equation incorporates the Hoek-Brown strength parameters for rock mass. In the current AASHTO specifications, these strength parameters are related empirically to the Rock Mass Rating (RMR). As discussed in Section 3.3.5, use of the RMR has been superseded by the Geological Strength Index (GSI) which provides a more direct correlation to the Hoek-Brown strength parameters. An overview of the Hoek-Brown strength criterion and its relationship to GSI is presented below.

For intact rock masses and for fractured or jointed rock masses, Hoek and Brown (1980) proposed an empirical criterion for characterizing rock mass strength. The criterion has undergone several stages of modification, most significantly by Hoek and Brown (1988) and Hoek et al. (1995, 2002). Since 1995 the Hoek-Brown strength criterion has been developed in conjunction with development of the Geological Strength Index (GSI), providing a practical tool for characterizing strength and deformation characteristics of rock mass. The nonlinear rock mass strength is given by:

$$\sigma'_1 = \sigma'_3 + q_u \left( m_b \frac{\sigma'_3}{q_u} + s \right)^a \quad 3-25$$

where  $\sigma'_1$  and  $\sigma'_3$  = major and minor principal effective stresses, respectively,  $q_u$  = uniaxial compressive strength of intact rock, and  $m_b$ ,  $s$ , and  $a$  are empirically determined strength parameters for the rock mass.

The Hoek-Brown strength parameters can be correlated to GSI, as follows. The value of the constant  $m$  for intact rock is denoted by  $m_i$  and can be estimated from Table 3-8, based on lithology. Suggested relationships between GSI and the parameters  $m_b/m_i$ ,  $s$ , and  $a$ , according to Hoek et al. (2002) are as follows:

$$\frac{m_b}{m_i} = \exp\left(\frac{\text{GSI}-100}{28}\right) \quad 3-26$$

$$s = \exp\left(\frac{\text{GSI}-100}{9}\right) \quad 3-27$$

$$a = \frac{1}{2} + \frac{1}{6} \left( e^{\frac{-\text{GSI}}{15}} - e^{\frac{-20}{3}} \right) \quad 3-28$$

**TABLE 3-8 VALUES OF THE CONSTANT  $m_i$  BY ROCK GROUP**  
 (After Marinos and Hoek, 2000; with updated values from Rocscience, Inc., 2007)

Rock type	Class	Group	Texture			
			Coarse	Medium	Fine	Very fine
SEDIMENTARY	Clastic		Conglomerate (21 ± 3)	Sandstone 17 ± 4	Siltstone 7 ± 2	Claystone 4 ± 2
			Breccia (19 ± 5)		Greywacke (18 ± 3)	Shale (6 ± 2)
						Marl (7 ± 2)
	Non-Clastic	Carbonates	Crystalline Limestone (12 ± 3)	Sparitic Limestone (10 ± 5)	Micritic Limestone (8 ± 3)	Dolomite (9 ± 3)
Evaporites			Gypsum 10 ± 2	Anhydrite 12 ± 2		
Organic					Chalk 7 ± 2	
METAMORPHIC	Non Foliated		Marble 9 ± 3	Hornfels (19 ± 4)	Quartzite 20 ± 3	
				Metasandstone (19 ± 3)		
	Slightly foliated		Migmatite (29 ± 3)	Amphibolite 26 ± 6	Gneiss 28 ± 5	
	Foliated*		Schist (10 ± 3)	Phyllite (7 ± 3)	Slate 7 ± 4	
IGNEOUS	Plutonic	Light	Granite 32 ± 3	Diorite 25 ± 5		
			Granodiorite (29 ± 3)			
	Dark	Gabbro 27 ± 3	Dolerite (16 ± 5)			
			Norite 20 ± 5			
	Hypabyssal		Porphyries (20 ± 5)		Diabase (15 ± 5)	Peridotite (25 ± 5)
Volcanic	Lava		Rhyolite (25 ± 5)	Dacite (25 ± 3)		
			Andesite 25 ± 5	Basalt (25 ± 5)		
	Pyroclastic	Agglomerate (19 ± 3)	Volcanic breccia (19 ± 5)	Tuff (13 ± 5)		

### 3.3.6.2 Deformation Properties

Rock mass deformation properties are used in analytical methods for predicting the axial load-deformation behavior of shafts bearing on or socketed into rock (Appendix C) and for establishing  $p$ - $y$  curves for analysis of rock sockets under lateral loading (Chapter 12). The required parameters include the modulus of deformation of the rock mass,  $E_m$ , and Poissons ratio,  $\nu$ . Values of Poisson's ratio exhibit

a narrow range of values, typically between 0.15 and 0.3, and are usually estimated. Methods for establishing design values of  $E_m$  include:

- estimates based on previous experience in similar rocks or back-calculated from load tests
- in-situ testing such as pressuremeter test, PMT (Table 3-7)
- empirical correlations that relate  $E_m$  to strength or modulus values of intact rock ( $q_u$  or  $E_R$ ) and GSI

Measurement of rock mass deformation modulus by PMT is discussed in Section 3.3.4 above. Empirical correlations that predict rock mass modulus ( $E_m$ ) from GSI and properties of intact rock, either uniaxial compressive strength ( $q_u$ ) or intact modulus ( $E_R$ ), are presented in Table 3-9. The recommended approach is to measure uniaxial compressive strength and modulus of intact rock in laboratory tests on specimens prepared from rock core. Values of GSI should be determined for zones of rock along the length of the proposed drilled shaft and over a depth of two diameters beneath the shaft tip. The correlation equations in Table 3-9 should then be used to evaluate modulus and its variation with depth. If pressuremeter tests are conducted, it is recommended that measured modulus values be calibrated to the values calculated using the relationships in Table 3-9.

**TABLE 3-9 CORRELATIONS BETWEEN GSI AND ROCK MASS MODULUS**

Expression	Notes/Remarks	Reference
$E_m(\text{GPa}) = \sqrt{\frac{q_u}{100}} 10^{\frac{\text{GSI}-10}{40}} \quad \text{for } q_u \leq 100 \text{ MPa}$	Accounts for rocks with $q_u < 100$ MPa; note $q_u$ in MPa	Hoek and Brown (1997); Hoek et al. (2002)
$E_m(\text{GPa}) = 10^{\frac{\text{GSI}-10}{40}} \quad \text{for } q_u > 100 \text{ MPa}$		
$E_m = \frac{E_R}{100} e^{\frac{\text{GSI}}{21.7}}$	Reduction factor on intact modulus, based on GSI	Yang (2006)

Notes:  $E_R$  = modulus of intact rock,  $E_m$  = equivalent rock mass modulus, GSI = geological strength index,  $q_u$  = uniaxial compressive strength. 1 MPa = 20.9 ksf.

### 3.4 GEOMATERIALS REQUIRING SPECIAL CONSIDERATION

Some geologic environments pose unique challenges for determination of material properties used for design of drilled shafts or for drilled shaft construction. Examples include the following:

- Argillaceous sedimentary rock
- Limestone and other carbonate rocks
- Glacial till
- Piedmont residual soils
- Cemented soils

Experience has demonstrated that the geomaterials listed above may require methods adapted to the specific geologic environment. Suggestions on how to approach characterization of the engineering properties for drilled shaft design or construction are presented in Appendix B. The reader may note that the first two material types listed above often fall into the category of cohesive IGM, which is one of the

four geomaterial categories for which design equations are presented in later chapters. Appendix B provides more detailed descriptions of approaches used successfully by state transportation agencies to design drilled shafts in these challenging geomaterials. Application of the term ‘special’ does not imply that the materials listed above are encountered infrequently. In some locations, these are the dominant geomaterials in which drilled shafts are used, and they can provide excellent support. Rather it suggests that for establishing their engineering properties, these materials may require techniques adapted to their unique characteristics.

### 3.5 GEOMATERIAL PROPERTIES AND LRFD

In the LRFD approach, soil and rock engineering properties are used to calculate foundation resistances and load-deformation response. Resistance factors are then applied to the calculated resistance components, for example side resistance or tip resistance of drilled shafts. Resistance factors are not applied directly to soil and rock strength properties. As presented in later chapters of this manual, resistance factors are established based on calibration studies and are specific to the design models used in the calibration. Studies conducted to date, and in future calibration studies, are based on the use of *mean* values of soil or rock properties for each geomaterial layer used to calculate resistance. Furthermore, some resistance factors account for the degree of variability in the measured soil property through the *coefficient of variation*, defined as the *standard deviation* divided by the *mean*. It is, therefore, critical that a sufficient number of measurements of soil and rock properties are made in order to provide the statistical parameters needed for application of LRFD to drilled shafts.

Variability of soil and rock property data used for design calculations should be assessed to determine if the observed variability is a result of inherent variability of subsurface materials and test methods or if the variability is a result of significant variations across the site or within a particular geologic unit. One approach to assess variability is to compare soil parameter variability for a particular stratum to published values of variability based on database information of common soil parameters. Table 3-10 is a compilation of ranges of values for coefficient of variation of common soil parameters (Duncan, 2000). Where the variability is deemed to exceed the inherent variability of the material and testing methods (exceeds the range in Table 3-10), or where sufficient relevant data are not available to determine a mean value and variability, a sensitivity analysis can be performed using average parameters and a parameter reduced by one standard deviation, i.e., “mean minus 1 sigma”, or a lower bound value. The results provide an assessment of the sensitivity of the analysis results to a range of potential design values. If the sensitivity analysis indicates that acceptable results are obtained and that the analysis is not particularly sensitive to the selected parameters, it may be acceptable to conclude the analysis. If the calculation results are not acceptable or the results are sensitive to the selected parameter, additional data collection/review and parameter selection are warranted.

For strength limit states of drilled shafts under axial loading, average measured values of relevant laboratory test data and/or in-situ test data were used to calibrate the resistance factors recommended in the current AASHTO specifications, at least for those resistance factors developed using reliability theory. To be consistent, average (mean) property values should therefore be selected for each identified stratum through which the drilled shaft derives its resistance. However, depending on the availability of soil or rock property data and the variability of the geologic stratum under consideration, it may not be possible to estimate reliably the average value of the parameter needed for design. In such cases, engineers may have no choice but to use a more conservative selection of design parameters to mitigate the additional risks created by potential variability or insufficient data.

In addition to standard methods described herein and in GEC No. 5 (Sabatini et al. 2002), AASHTO (2007) permits the use of local geologic formation-specific correlations if well established by data

comparing the prediction from the correlation to measurements from high-quality laboratory test data or back-analysis from full-scale performance of the geotechnical elements (*i.e.*, drilled shafts) affected by the geologic formation in question.

**TABLE 3-10 VALUES OF COEFFICIENT OF VARIATION, V, FOR GEOTECHNICAL PROPERTIES AND IN-SITU TESTS (SABATINI et al., 2002, after Duncan, 2000)**

Measured or interpreted parameter value	Coefficient of Variation, V (%)
Unit weight, $\gamma$	3 to 7 %
Buoyant unit weight, $\gamma_b$	0 to 10 %
Effective stress friction angle, $\phi'$	2 to 13 %
Undrained shear strength, $s_u$	13 to 40 %
Undrained strength ratio ( $s_u/\sigma_v'$ )	5 to 15 %
Compression index, $C_c$	10 to 37 %
Preconsolidation stress, $\sigma_p'$	10 to 35 %
Hydraulic conductivity of saturated clay, $k$	68 to 90 %
Hydraulic conductivity of partly-saturated clay, $k$	130 to 240 %
Coefficient of consolidation, $c_v$	33 to 68 %
Standard penetration blowcount, $N$	15 to 45 %
Electric cone penetration test, $q_c$	5 to 15 %
Mechanical cone penetration test, $q_c$	15 to 37 %
Vane shear test undrained strength, $s_{uVST}$	10 to 20 %

### 3.6 SUMMARY

Methods for selecting soil and rock properties for design of drilled shaft foundations are presented in this chapter. Geomaterials are placed into one of four categories: cohesionless soils, cohesive soils, rock, and cohesive IGM's. The most common in-situ and laboratory tests used to establish the strength and deformation properties of each geomaterial are described. An overview is presented on characterization of rock mass for engineering applications. The engineering properties described in this chapter are used in design equations for geotechnical resistances of drilled shafts under lateral loading (Chapter 12) and axial loading (Chapter 13).

## CHAPTER 4 GENERAL CONSTRUCTION METHODS

### 4.1 INTRODUCTION

The effective use and design of drilled shafts requires knowledge of the construction methods used for these foundation elements. Drilled shaft construction is sensitive to the ground conditions encountered at the site, and the costs and magnitude of effort involved are closely tied to the ground conditions and the construction techniques that must be used for a particular circumstance. Performance is related to the effectiveness of the construction technique in preserving the integrity of the bearing materials and ensuring the structural integrity of the cast-in-place reinforced concrete drilled shaft foundation.

In principle, construction of drilled shafts is a very simple matter; a hole is drilled into the ground and concrete is placed into the hole. The practice is more complex:

1. The hole must be excavated, sometimes to great depths through very difficult and variable materials ranging from soft soils to hard rock,
2. The hole must then be kept open and stable, often at great depths in caving soils below the groundwater table, without adversely affecting the bearing stratum,
3. The reinforced concrete must be cast in the excavated hole in such a way as to ensure good bond and bearing into the founding stratum in order to transfer large axial and lateral forces to the founding stratum, and
4. The completed drilled shaft must be a competent structural element that provides sufficient structural strength in compression, tension, and flexure to transfer the loads from the structure.

The principal features of the typical methods used for construction of drilled shafts are described in this chapter. Specific particulars of the general methods used for construction on a given project can vary with project-specific ground conditions as well as the capabilities, experience, and equipment of an individual constructor. However, the information presented here and in the other chapters that deal with construction should provide the basis for an understanding of the various methods that may be employed. Subsequent chapters will address more detailed issues relating to tools and equipment, casing, drilling slurry, rebar cages, and concrete.

In normal contracting practice for transportation projects in the U.S., it is the contractor's responsibility to choose an appropriate method for installing drilled shafts at a given site. The efficiency and cost-effectiveness of the means and methods chosen for a particular circumstance are thus the contractor's burden. Unwarranted interference affecting the contractor's ability to prosecute the work can lead to claims and additional costs. However, designers and other project professionals must be familiar with construction methods because:

**Foundation Type Selection:** The appropriate selection of drilled shafts for a particular project requires an understanding of construction in order to identify those conditions which favor the use of drilled shafts in lieu of alternative foundation types.

Site Investigation: An understanding of geotechnical factors affecting drilled shaft construction is needed in order to execute a site investigation plan which is appropriate for the project.

Effect of Construction on Performance: Some construction methods may adversely affect the performance of the drilled shaft foundation (or nearby structures) under some circumstances, and may need to be excluded by the project design professionals as an option for these specific site conditions.

Specifications and Inspection Methods Appropriate construction specifications and inspection techniques must be developed that encompass the methods likely to be used by the contractor on a specific project.

Costs: Accurate preliminary cost estimates require an understanding of construction methods, as the cost of construction is dependent upon the anticipated construction method. In addition, the cost structure of the contract documents should be appropriate for the work.

Differing Site Conditions: An understanding of construction methods is required in order to evaluate a contractor's claim for equitable adjustment of costs due to unanticipated conditions.

There are likely many more reasons for design professionals to understand the essentials of drilled shaft construction techniques, not the least of which is that it is an interesting subject for any engineer! Since the early days of modern U.S. bridge engineering construction with pneumatic caissons (for instance, construction of the Brooklyn Bridge, described by McCullough, 1972), engineers have recognized the critical importance of a well-constructed foundation and the impact of foundation construction on the performance, costs, and schedule of the project.

For general discussion of construction methods, the approach to construction can be classified in three broad categories.

These are:

1. The dry method.
2. The casing method.
3. The wet method.

In many cases, the installation will incorporate combinations of these three methods to appropriately address existing subsurface conditions. Because elements of the drilled shaft design can depend on the method of construction, consideration of the construction method is a part of the design process.

## **4.2 DRY METHOD OF CONSTRUCTION**

Dry hole construction, illustrated in Figure 4-1, represents the most favorable conditions for economical use of drilled shafts. The dry method is applicable to soil and rock that is above the water table and that will not cave or slump when the hole is drilled to its full depth during the period required for installation of the drilled shaft. A homogeneous, stiff clay can often be drilled in this manner, and sometimes homogeneous stiff clay can be drilled to moderate depths (up to 50 ft) using the dry method regardless of the long term groundwater levels because of the extremely low hydraulic conductivity of the soil. The dry method can be employed in some instances with sands above the water table if the sands contain some cementation or cohesive material, or if they will stand for a period of time because of apparent cohesion. This behavior generally cannot be predicted unless there is prior experience with the specific formation being excavated or full-sized test excavations have been made during site characterization.





Figure 4-1 Dry Hole in Stable Soil

Because virtually any type of soil may tend to cave near the surface, a short piece of casing, called a "surface" casing, should be employed, especially if the rig will be bearing on the soil close to the hole. The surface casing may be temporary or permanent. Surface casings are recommended practice in all soils, and should be left protruding above the ground surface to serve as drilling tool guides, as safety barriers for personnel (although other barriers can be used), and as means of preventing deleterious material from falling into the borehole after it has been cleaned.

With clays of low permeability or rock, it is sometimes possible to drill a "dry" hole below the long term groundwater level for the short period of time required to complete the shaft excavation. Some small amount of seepage may be observed under such conditions, and may be tolerated if:

- The stability of the excavation is not jeopardized by the seepage
- The amount of seepage water collecting at the base of the excavation or seeping into the excavation is not so much as to preclude completion of the excavation and placement of the concrete in a relatively dry condition.

The stability of the excavation is dependent upon the nature of the soils and stratigraphy. Heavily fissured or slickensided clays, or predominantly clay soil profiles containing silt or sand layers having thickness of more than an inch or two may result in sloughing, excessive seepage or both. In such conditions, the contractor should immediately employ casing or slurry methods. If the site investigation identifies the potential for wet conditions to be encountered, the engineer may preclude the use of the dry method of construction. Otherwise, the contractor must have the necessary equipment available on-site to adopt alternate methods when necessary. Note also that even if long term deep groundwater conditions are identified during the site investigation, shallow permeable layers can result in perched water conditions, particularly during or after rainy weather. With stable rock excavation below water, some seepage can be encountered coming from fissures or seams within the rock without jeopardizing stability of the excavation. A small amount of seepage may be tolerable; however, the rate of seepage and quantity of standing water in the shaft excavation must be limited to avoid adverse effect on the quality of the shaft concrete.

In general, no more than three inches of water should be present within the base of the excavation at the time of concrete placement, and the rate of inflow should be confirmed by observation to be less than 12 inches per hour. If seepage is present, a downhole pump should be employed immediately prior to concrete placement to remove as much water as possible. If seepage exceeds the tolerable levels cited above, the hole should be flooded and concrete placed using wet methods as described in subsequent sections of this chapter.

With conditions favorable for a dry excavation, most often a simple rotary auger will be employed, and the operator will remove as much material in one pass as the equipment is capable of handling. The rig is rotated to the side away from the hole and the tool spun to remove the spoil as shown in Figure 4-2. The excavation is carried to its full depth with the spoil from the hole removed from the area by a loader or other equipment. After the excavation has been carried to its full depth, a different tool such as a special clean-out bucket is often used to clean the base of the excavation of loose material. Hand cleaning is possible, but it should not be used unless absolutely necessary and only with the required safety measures (safety casing, air supply, safety harness, radio communication, etc.). More information regarding tools and equipment is provided in Chapter 5.



Figure 4-2 Cuttings from a Dry Hole Spun off the Auger

After the base of the shaft is cleaned, inspected, and approved, the shaft is completed by placing the reinforcement and concrete. The reinforcing cage is typically lowered into position within the hole and then concrete placed through the center of the shaft, flowing through the reinforcement to fill the hole. If a full length cage is used, the bottom of the longitudinal bars may be equipped with spacers or “feet” in order that the cage can be set onto the bottom of the shaft (Figure 4-3). Note that in some cases, the reinforcing cage may be placed only in the upper portion of the drilled shaft, presumably for a case in which bending moments are relatively low and a full length cage is not required. The partial-depth cage would be supported by surface skids as the concrete hardens.

In a dry shaft excavation, concrete may be placed by the “free-fall” method, directing the flow into the center of the shaft to avoid hitting the cage or the sides of the hole and dislodging soil debris. The worker in Figure 4-4 is using the last section of the chute from the delivery truck to direct concrete, as in this case the contractor is able to position the delivery truck near the top of the excavation; in other cases a pump line or buckets may be used to deliver concrete to the shaft. In some cases a centering hopper or a short section of tremie pipe is used to direct the concrete down the center of the shaft. Reinforcement and concrete will be discussed in more detail in Chapters 8 and 9.

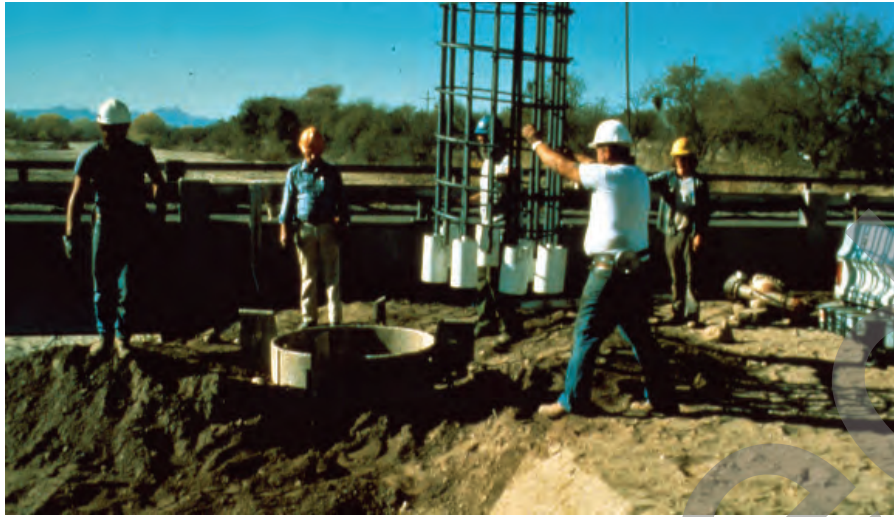


Figure 4-3 Placement of Reinforcing Cage into the Excavation



Figure 4-4 Placement of Concrete into a Dry Excavation

The construction process with a dry hole is illustrated in Figure 4-5:

- a. The shaft is excavated using augers which will likely have teeth to break up the soil.
- b. The base is cleaned using a bucket or flat bottom tool to remove loose debris and possibly any small amount of water.
- c. In most typical transportation projects, a full length reinforcing cage is placed.
- d. The concrete is placed using a drop chute or centering device.

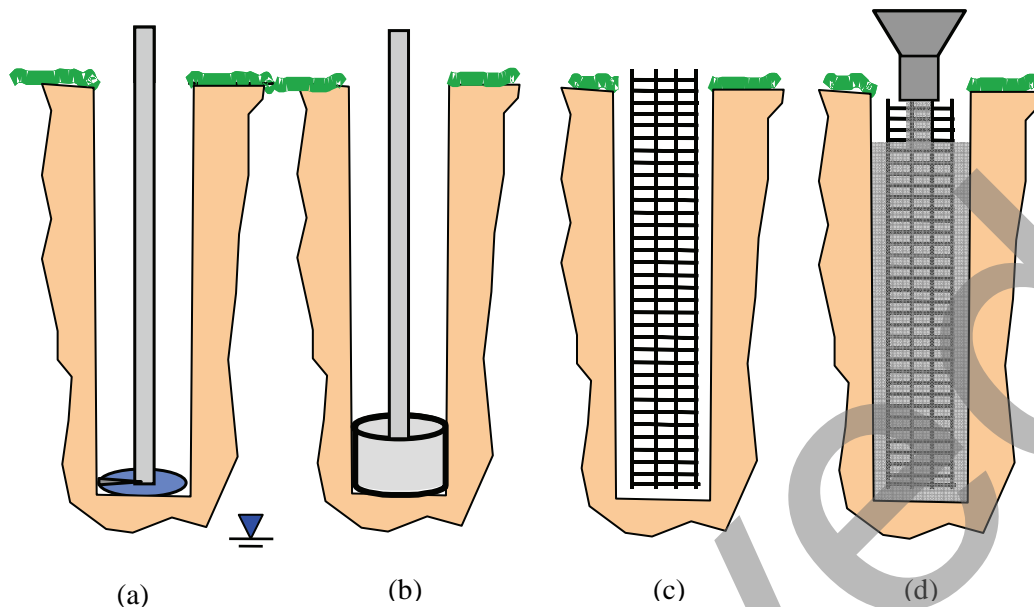


Figure 4-5 Dry Method of Construction: (a) Drill the Hole; (b) Clean the Base; (c) Place Reinforcement; (d) Place Concrete

Construction of a shaft using the dry method and open holes should generally be completed in one continuous operation without stopping. Any excavation left open overnight should be cased through soil layers to protect against cave-ins. Dry holes in stable rock formations can be left open overnight without casing. All open holes should be covered for safety.

The length of time necessary to complete the excavation will depend on the soil conditions, the presence of obstructions, and the geometry of the hole. Where homogeneous stiff clays exist, a hole that is 3 ft in diameter can probably be drilled to a depth of 50 ft in less than 1 hour. A longer period of time will be required, of course, if obstructions are encountered or if unforeseen caving occurs that requires conversion to one of the other construction methods. Rock excavation rates can vary widely from less than a foot to as much as 10 or more feet per hour.

### 4.3 CASING METHOD OF CONSTRUCTION

The casing method is applicable to sites where soil conditions are such that caving or excessive soil or rock deformation can occur when a shaft is excavated. Casing can also be used to extend the shaft excavation through water or permeable strata to reach a dry, stable formation. Unless the bearing formation into which the casing is sealed is stable and dry, it will not be possible to use the casing method alone without the addition of drilling fluid or water.

Installation of casing is generally accomplished in one of three ways.

1. Excavate an oversized hole using the dry method, then place the casing into the hole. This method is suitable only for construction in soils that are generally dry or have slow seepage and that will remain stable for the period of time required to advance the hole to the more stable

bearing stratum. The shaft in Figure 4-6 was excavated in East Tennessee through overburden soils to rock in the dry, and then a casing was placed through the soils to rock to prevent caving while the rock socket was drilled.

2. Excavate an oversized hole through the shallow permeable strata using a drilling fluid, then place and advance the casing into the bearing stratum. After the casing is sealed into the underlying more stable stratum, the drilling fluid can be removed from inside the casing and the hole advanced to the final tip elevation in the dry. A schematic diagram of this approach is provided in Figure 4-7. Note that since the drilling fluid will have to be flushed out later by the fluid concrete, it must meet all of the requirements for slurry used in the wet method described in Section 4.4.
3. Advance the casing through the shallow permeable strata and into the bearing formation ahead of the shaft excavation, and then excavate within the casing in the dry. With this approach, casing may be driven using impact or vibratory hammers or using a casing oscillator or rotator with sufficient torque and downward force to advance the casing through the soil ahead of the excavation. Even larger upward force may be required to pull the casing during concrete placement. A schematic diagram of this approach is provided in Figure 4-8.

Full length temporary casing should always be used if workers are required to enter the excavation, as illustrated in Figure 4-6.

Most casing is made of steel and is recovered as the concrete is being placed. In some circumstances, permanent casing may be used and left in place as a form or as a structural element required in the design of the drilled shaft. Instances requiring the use of permanent casing are discussed in Chapter 6, as are other characteristics of temporary and permanent casings.



Figure 4-6 Drilling into Rock through a Cased Hole

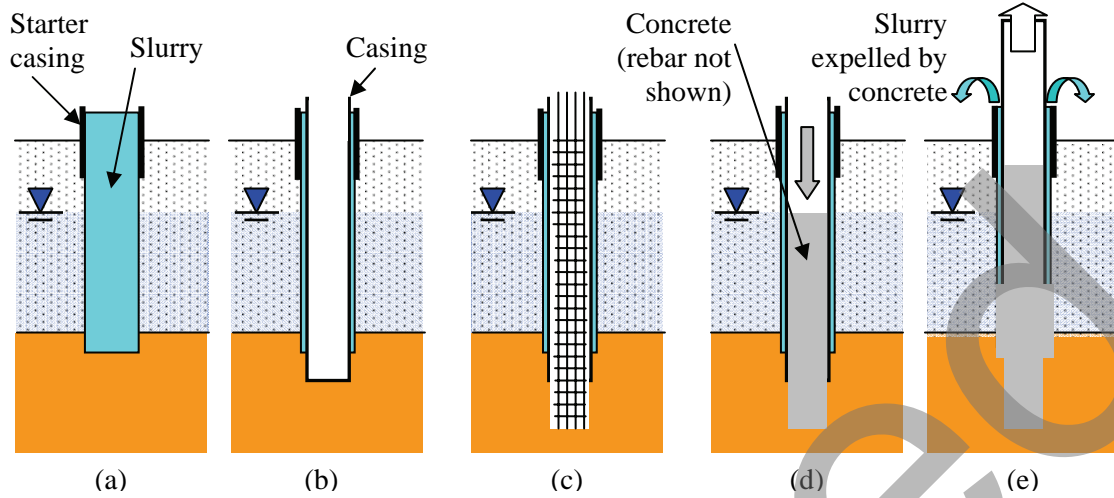


Figure 4-7 Construction Using Casing Through Slurry-Filled Starter Hole: (a) drill with slurry; (b) set casing and bail slurry; (c) complete and clean excavation, set reinforcing; (d) place concrete to head greater than external water pressure; (e) pull casing while adding concrete

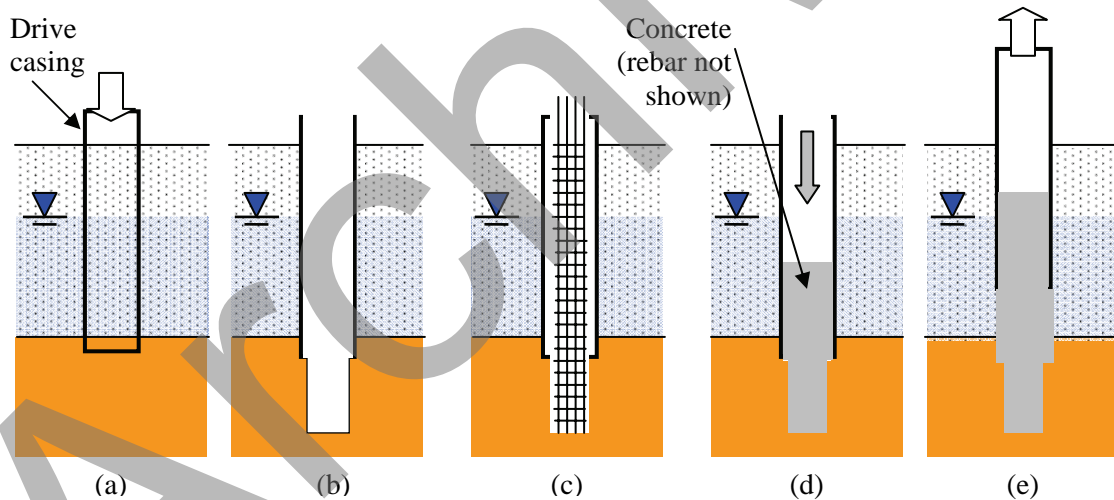


Figure 4-8 Construction Using Casing Advanced Ahead of Excavation: (a) drive casing into bearing stratum; (b) drill through casing; (c) complete and clean hole, set reinforcing; (d) place concrete to head greater than external water pressure; (e) pull casing while adding concrete

In most cases, the shaft excavation will be advanced below the base of the casing for some distance into the bearing formation of soil or rock, and it is necessary that the casing achieve a seal into this bearing formation in order to control caving or seepage around the bottom of the casing. If the casing is driven

with a hammer or oscillator, this machine must have sufficient capability to force the casing into the bearing layer. An oscillator, shown in

Figure 4-9, is a hydraulic-powered machine which twists and pushes a segmental-joined casing into the soil. A vibratory hammer is shown on the left of Figure 4-10. The advancement of the casing by the drill rig is normally achieved by attaching a twister bar as shown on the right in Figure 4-10 so that the rig can apply torque and possibly down force onto the casing. Sometimes the casing is equipped with cutting teeth or carbide bits at the bottom to assist in penetration into a hard layer, as shown in Figure 4-11. A more complete description of tools and equipment used to install casing is provided in Chapter 6.



Figure 4-9 Oscillator Rig Used to Advance Segmental Casing Ahead of the Excavation



Figure 4-10 Use of a Vibro-Hammer (Left) and Twister Bar (Right) to Advance Casing



Figure 4-11 Cutting Teeth on the Casing to Assist Penetration into the Bearing Stratum

Failure to seal the casing into a watertight formation can result in the inflow of groundwater or sand around the bottom of the casing, resulting in formation of a cavity around the casing. Such a cavity could produce ground subsidence or even collapse at the ground surface. Besides the obvious deleterious effect of ground disturbance and the safety hazard that would be associated with ground movements, this unstable condition can affect adjacent structures. In addition, a large cavity outside the shaft excavation could require a large and unexpected volume of concrete during filling. If a large volume of concrete is lost into a cavity at the time the casing is pulled (step *e*) in Figure 4-7 or Figure 4-8), it may be possible that the level of concrete inside the casing could drop so much that the seal of the casing into the concrete could be breached allowing inflow of groundwater or drilling fluid. This breach would result in contamination of the concrete, as illustrated in Figure 4-12. In order to minimize the risk of a large drop in the concrete head within the casing, most contractors would only pull the casing a small amount to break the seal and initiate the flow of concrete behind the casing, and then immediately add more concrete into the casing.

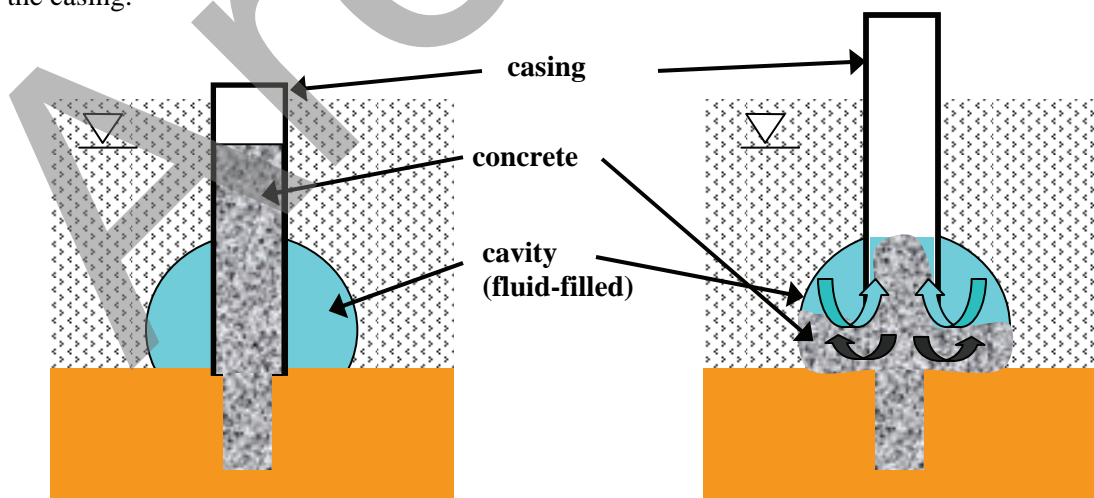


Figure 4-12 Breach of Casing/Concrete Seal During Casing Extraction Due to Cavity



Because of the importance of the permeability of the bearing stratum for construction in the dry within a casing, it is important that this aspect of the soil conditions be evaluated during the site exploration. If the permeability of the bearing stratum is not sufficiently low, seepage could enter the excavation as the slurry is removed. With this condition it may be impossible to remove the groundwater from the excavation, and continued attempts to do so could result in instability of the excavation below the casing. In such a case, the excavation should be completed in the wet as described in the following section. With casing through weaker strata, it may be possible to complete the wet shaft using water as a drilling fluid in lieu of slurry. The casing would still serve to prevent collapse of the soil, and the concrete can be placed underwater with a tremie with simultaneous (or subsequent) extraction of the casing as described in Section 4.4.

With the casing method, the reinforcing cage will usually need to extend to the full depth of the excavation because it is difficult to keep a partial-length cage in position by a hoist line around which the casing is pulled. Besides the structural requirements, the reinforcing cage must also be designed for the constructability requirements, including stability during pickup and placing of the cage, during the placing of concrete, and during withdrawal of the casing. Out-hook bars should be avoided because of the need to withdraw casing over the cage. Since it is generally necessary to release the cage during withdrawal of the casing, it is necessary that the cage be sufficiently stable that it can stand freely under self-weight in the hole during construction without racking or distorting. Spacers are used to keep the reinforcement cage centered. Because the concrete must flow through the cage to fill the space of and around the casing, there must be sufficient space between bars to permit the free flow of concrete during concrete placement. Additional details relating to reinforcement are provided in Chapter 8.

The concrete used with the casing method must have good flow characteristics in order to flow easily through the reinforcing to fill the space outside the casing and displace any water or slurry around the casing from the bottom up. It is critical that the concrete maintain a hydrostatic pressure greater than that of the fluid external to the casing (trapped slurry or groundwater) as described previously and illustrated in Figure 4-7 and 4-8. The concrete will then flow down around the base of the casing to displace the trapped slurry and fill the annular space. The casing should be pulled slowly in order to keep the forces from the downward-moving concrete on the rebar cage at a tolerable level.

The concrete must also retain its workability beyond the duration of the concrete placement operations until the casing is completely removed. If the workability of the concrete (slump) is too low, arching of the concrete will occur and the concrete will move up with the casing, creating a gap into which slurry, groundwater, or soil can enter. The rebar cage may also be pulled up along with the casing and stiff concrete. Even if arching within the casing does not occur, concrete with inadequate workability will not easily flow through the cage to fill the space between reinforcing and the sides of the hole. Downward movement of the cage upon casing withdrawal could indicate that the concrete is pulling the cage laterally toward a void or that the cage is dragged downward into a distorted position due to the downdrag from concrete with inadequate workability. Downward movement of the column of concrete will cause a downward force on the rebar cage; the magnitude of the downward force will depend on the shearing resistance of the fresh concrete and on the area of the elements of the rebar cage. The rebar cage can fail at this point by torsional buckling, by slipping at joints, and possibly by single-bar buckling (Reese and O'Neill, 1995). Additional details relating to concrete are provided in Chapter 9.

The casing method of construction dictates that the diameter of the portion of the drilled shaft below the casing will be slightly smaller than the inside diameter of the casing. In connection with casing diameter, most of the casing that is available is dimensioned by its outside diameter and comes in 6-inch nominal increments of diameter. A contractor would ordinarily use a casing with the increment of outside diameter that is the smallest value in excess of the specified diameter of the borehole below the casing. If casing

diameter is specified in other than standard sizes, special pipe may have to be purchased by the contractor, and the cost of the job will be significantly greater.

Casing sometimes needs to be used to stabilize very deep shafts and/or into very strong soil or rock which may make it difficult to remove the casings. In such instances, contractors may choose to "telescope" the casing, as illustrated in the photo of Figure 4-13. With this approach, the upper portion of the shaft is excavated and a large-diameter casing sealed into a suitable stratum. A smaller-diameter shaft will then be excavated below the bottom of the casing and a second casing, of smaller diameter than the first casing, will be sealed into another suitable stratum at the bottom of the second-stage of excavation. The process can be repeated several times to greater and greater depths until the plan tip elevation is reached. With each step, the borehole diameter is reduced, usually by about 6 inches, so that the contractor must plan for the multiple casing approach from the start. This procedure is often used where the soil to be retained contains boulders.

If the top of the interior casing(s) are set below the top of the uppermost casing as shown in Figure 4-13, the contractor must withdraw casing during concrete placement starting with the innermost, being careful to avoid overflowing any casing with concrete and trapping debris below concrete.



Figure 4-13 Telescoping Casing

#### 4.4 WET METHOD OF CONSTRUCTION

When soil conditions do not permit dewatering of the shaft excavation, the excavation and concrete placement operations must be completed "in the wet". With this method, the hole is kept filled with a fluid during the entire operation of drilling the hole and placing the reinforcing and concrete. The drilling fluid may consist of water if the hole is stable against collapse, or a prepared slurry designed to maintain stability of the hole.

Several circumstances in which construction in the wet would be used are described below.

- The shaft is founded in a sand or permeable stratum which will collapse or become unstable during excavation. A drilling slurry is required to maintain the stability of the hole and prevent inflow of groundwater.
- The shaft is founded in a stable formation, but extends through caving or water-bearing soils of such depth and thickness that the required casing would be very long and difficult to handle. A drilling slurry is required to maintain the stability of the hole and prevent inflow of groundwater.
- A full length casing is driven in advance of the excavation (as described in the previous section), but the soil or rock conditions at the base are permeable and do not permit dewatering. Because the full length casing provides a stable hole, plain water can often be used instead of slurry.
- The hole is cased to a stratum of rock which is stable, but groundwater inflow is greater than 12 inches per hour. In this case, the hole is kept filled with water to prevent inflow during concrete placement.

When a hole is filled with slurry and the elevation of the slurry in the hole is higher than the elevation of the groundwater in the soil, the hydraulic gradient between the fluid in the hole and the soil will force the fluid to try to flow out into the soil as illustrated on Figure 4-14. This seepage pressure acting against the borehole wall provides stability to the excavation sidewall. Because water flows out readily into permeable soils, the high rate of fluid loss makes it difficult or impossible to maintain the excess head of fluid in the hole. In such cases, drilling slurry would be used to provide the necessary stabilization of the shaft excavation. Drilling slurry is formed by adding mineral bentonite or synthetic polymers to increase the viscosity and reduce the rate of fluid loss in the hole so that a hydraulic slurry head can be maintained at all times that is at least 5 (or more) feet higher than the hydraulic head from the groundwater. The properties of drilling slurry and of the mineral or synthetic additives are described in detail in Chapter 7.

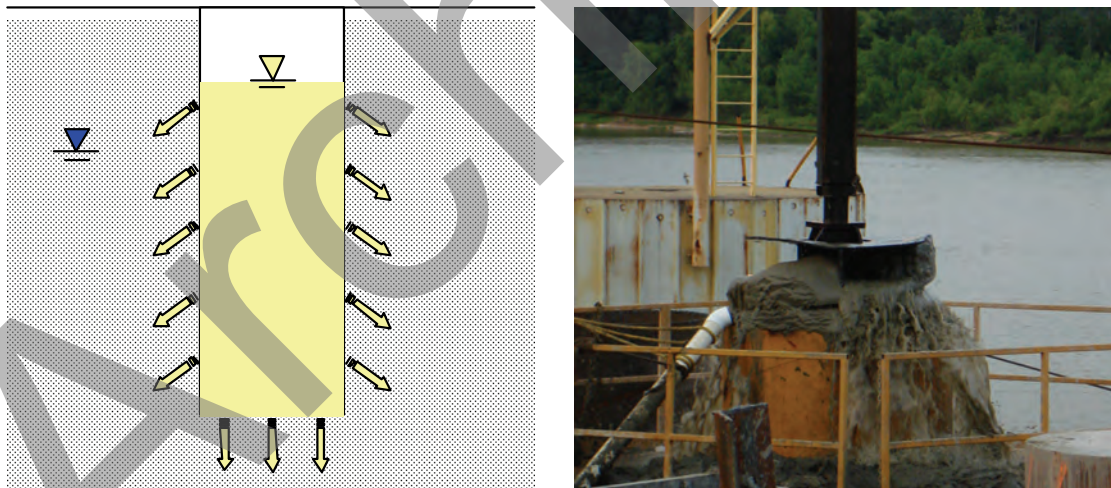


Figure 4-14 Slurry Provides Seepage Pressure against Excavation Surface

The slurry drilling method is illustrated on the diagram of Figure 4-15. Typical construction would include a starter or surface casing extending above the ground surface as shown in Figure 4-15a. This surface casing may extend as deep as necessary to prevent surface cave-ins and may extend above the ground surface to elevate the surface level of the slurry in the hole, as shown in Figure 4-15b. Note that the groundwater elevation (piezometric surface) is shown by the blue triangle in Figure 4-15. In order to maintain the head of slurry at least 5 ft above the piezometric surface, it is essential that the piezometric

surface be known in advance. The presence of overlying cohesive soils may mask the actual elevation of the piezometric surface; drilling into the underlying water-bearing sand stratum without sufficient head of slurry could lead to liquefaction conditions at the base of the hole during drilling, loosening of the stratum, and possibly collapse of the hole or creation of a large cavity.

After completion of the excavation and cleaning of the base, the reinforcing cage is placed and then concrete placement is performed using a tremie (Figure 4-15c-e). The tremie delivers concrete to the base of the shaft and displaces slurry upwards. Typically, the slurry is pumped to a holding tank for reuse or disposal. Concrete placement continues through the tremie, always keeping the bottom of the tremie at least 10 ft below the rising surface of the fresh concrete so that the concrete does not mix with the slurry. It is important to avoid potential inclusions of slurry or sand which may be in suspension within the slurry into the concrete. Therefore, it will be necessary that the slurry be appropriately cleaned of suspended solids and within specifications as outlined in Chapter 7. It is also important that the concrete have sufficient workability to flow easily through the tremie and reinforcing throughout the duration of the concrete placement operations. More details on the important properties of concrete are provided in Chapter 9.

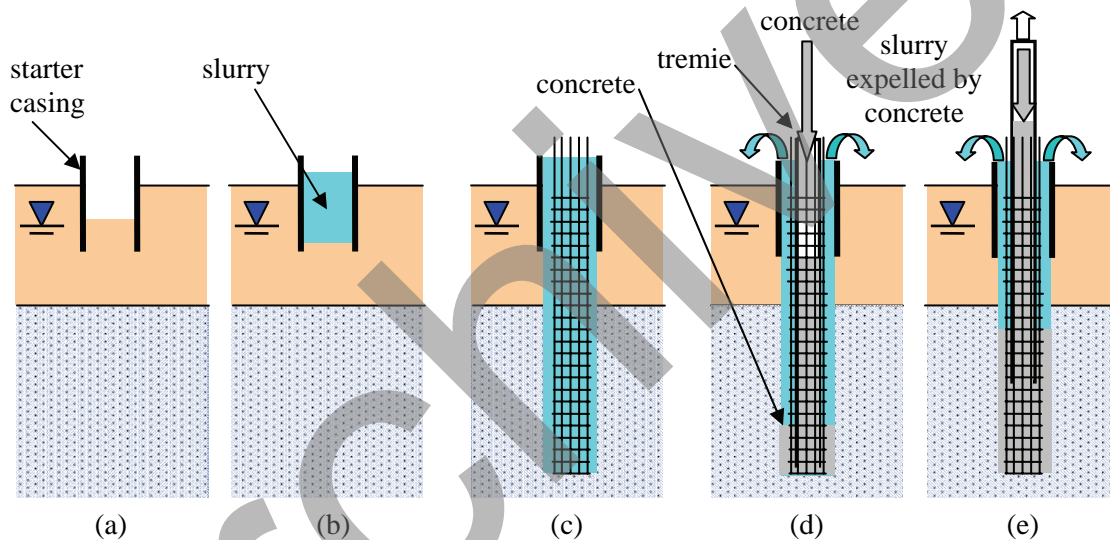


Figure 4-15 Slurry Drilling Process: (a) set starter casing; (b) fill with slurry; (c) complete and clean excavation, set reinforcing; (d) place concrete through tremie; (e) pull tremie while adding concrete

Artesian groundwater conditions in a confined aquifer can pose a significant challenge and could require a starter casing with significant height above the ground surface in order to maintain proper head in the shaft. An alternate approach may be to temporarily reduce artesian pressure in the vicinity of the drilled shaft excavation by use of dewatering wells near the work area. For such conditions, it is vitally important that the subsurface investigation identify potential sources of artesian pressure. Where tall surface casing is required, the contractor must provide equipment that can reach up and over the casing. Figure 4-16 is a photo of the placement of the reinforcement into a shaft during the reconstruction of the I-35W bridge over the Mississippi River in Minnesota, for which the subsurface sandstone bearing formation produced an artesian head approximately 14 ft above ground level.



Figure 4-16 Use of Surface Casing to Overcome Artesian Groundwater

In the vast majority of projects, the excavation is completed using drilling methods and tools similar to those used with dry excavation methods. One important consideration with drilling in wet conditions is that the tool used provide a passage for drilling fluids through or around the tool, and that the drill rig operator withdraw the tool slowly so that suction pressure below the tool does not occur. A reduction in pressure due to rapid withdrawal of the drilling tool could result in loss of the stabilizing excess fluid pressure within the excavation and subsequent collapse near the bottom of the hole or heaving of the base of the excavation. The bottom clean-out bucket shown in Figure 4-17 includes portals for slurry passage through the tool.

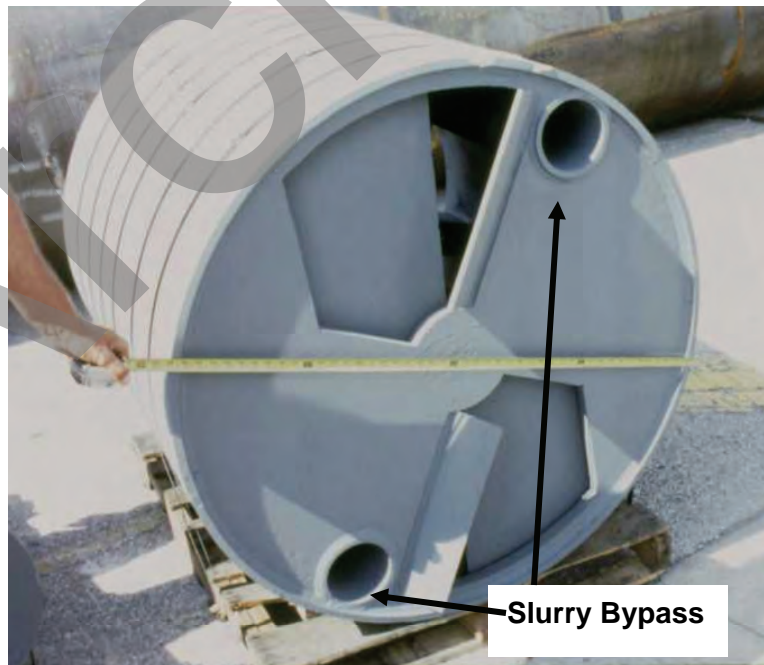


Figure 4-17 Bottom Clean-out Bucket with Portal for Slurry Passage

When advancing a shaft excavation through unstable soil using casing, it is important that excavation within the casing be limited so as not to produce unstable bottom conditions as illustrated in Figure 4-18. If excavation within the casing is performed as the casing is advanced, the construction crew should generally maintain a soil plug of sufficient thickness within the casing to avoid bottom heaving. The plug should be maintained until the excavation reaches either a stable stratum (such as rock, cemented soil, or cohesive soil) or the final shaft bottom elevation.

Upon completion of the shaft in cohesionless soil, care must be taken to avoid instability at the base of the casing as bottom heave could produce loosening of the bearing stratum. The drilling fluid inside the casing may be kept at a high elevation by pumping to maintain an excess head in the hole and a positive seepage pressure against the soil at the base. If the casing is seated into strongly cemented soil or rock, bottom stability may be less of a concern.

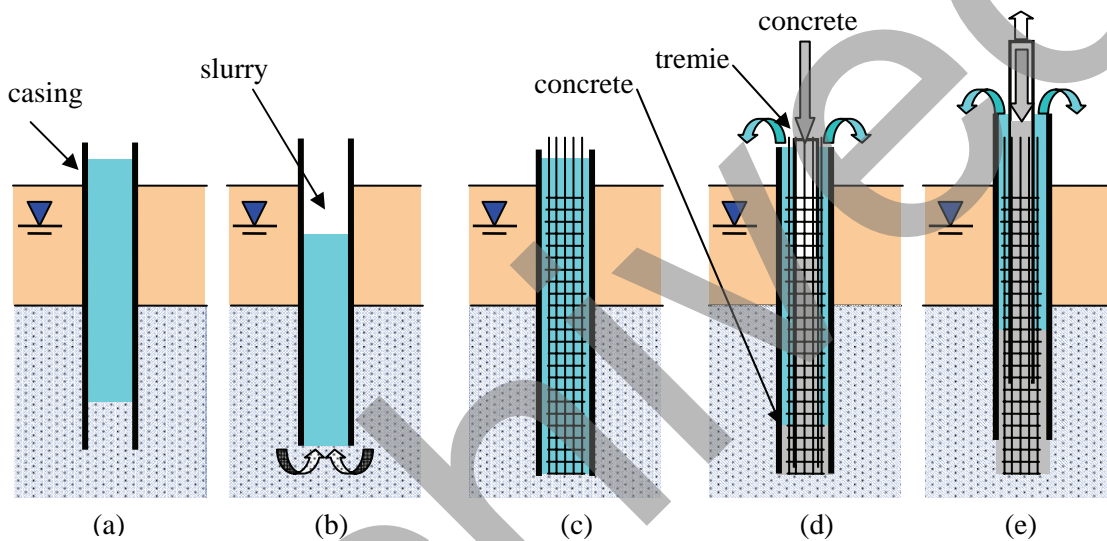


Figure 4-18 Wet Hole Construction Using Full Length Casing: (a) advance casing and excavating, while maintaining soil plug within casing through caving soils; (b) bottom instability due to inadequate slurry level and/or soil plug at base in caving soils; (c) complete and clean excavation, set reinforcing; (d) place concrete through tremie; (e) pull tremie, casing while adding concrete

Reverse circulation drilling is an alternate method which may occasionally be used for construction of a wet-hole shaft. A schematic diagram of the reverse circulation drilling process is illustrated on Figure 4-19, along with a photo of a machine in action with the cutter head in the foreground. The rig advances the full face cutting head (similar to a tunnel boring machine) downward while the cuttings from the face are conveyed upward through the center pipe. This process is reversed from the wet rotary drilling of soil borings or water wells in which the drilling fluid is conveyed down through the center pipe and up through the annular space between the hole and the pipe, hence the name “reverse circulation”. Reverse circulation is used for large diameter holes since the smaller cross-sectional area of the drill pipe provides the upward velocity needed to lift the cuttings, which otherwise would not be achieved in such a large hole as is typical of drilled shafts. The drilling fluid and cuttings are removed from the face by an air lift or other type of pump, with an opening on the cutting head often offset from the center of rotation as can be seen in the photo at bottom right. This technique is also applied with construction of diaphragm walls using a similar machine called a “hydromill” or “hydrophase” in which two or more cutters rotate in a vertical plane to cut a rectangular shaped panel.

The advantage of reverse circulation drilling is that very deep holes can be advanced without the need to cycle in and out of the hole with the drill tools to remove cuttings. The technique is used rarely in the U.S. at present (2009) and mostly for large deep shafts. Reverse circulation drilling is much more common in southeastern Asia. Some drilled shafts are constructed in Asia using conventional drill rigs equipped with reverse circulation tooling. A proprietary version of this process, known as the "Tone" method (developed by the Tone Corporation in Japan), uses a downhole hydraulic motor to power the drilling tool. Skids held against the side of the borehole act as a torque reaction and directional guide, and a flexible line transports the slurry and cuttings to the surface. Therefore, it does not require a string of drill pipe and can be operated by using a very small crane with low headroom (20 ft or less).

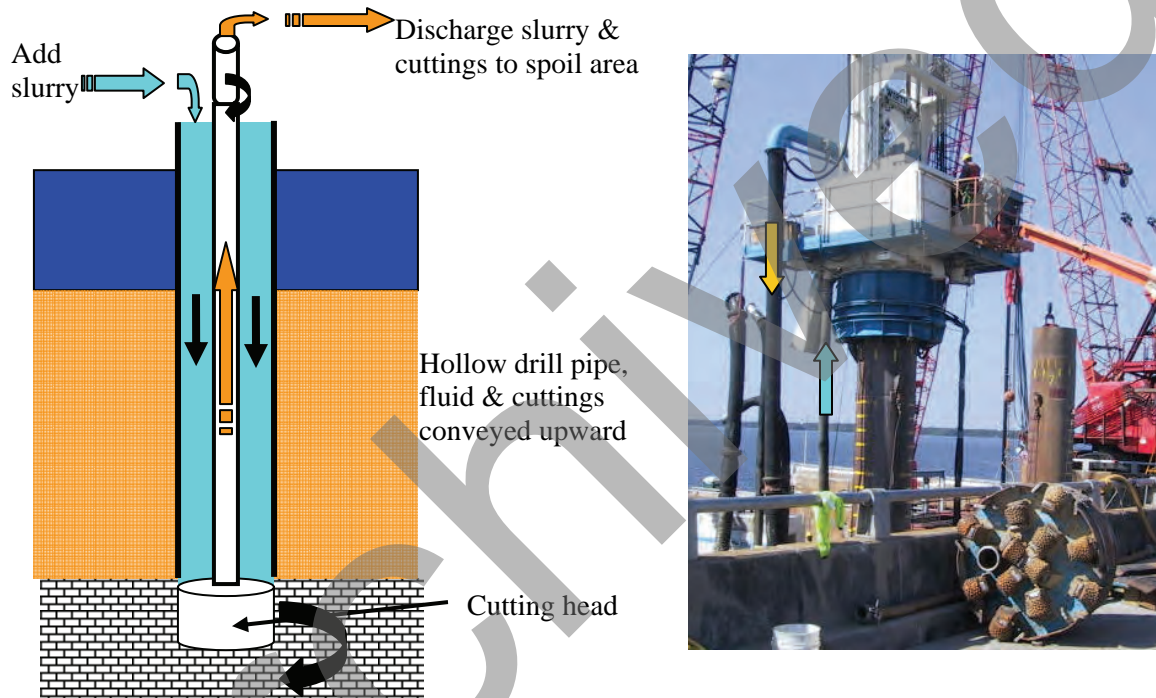


Figure 4-19 Reverse Circulation Drilling

#### 4.5 BASE GROUTING

The application of grout under pressure, applied at the base of the shaft after concrete has cured, is sometimes used to improve the base resistance of drilled shafts in cohesionless soils. Base grouting can also be used to compress and cement loose sediments left at the base of the shaft after excavation and bottom cleaning operation. The base grouting process entails installation of a grout delivery system during the reinforcing cage preparation. The shaft is constructed as normal, and grout is injected under high pressure once the concrete has gained sufficient strength. Reaction for the grout pressure acting at the base is supplied by side shear acting downward, and thus the shaft is pre-compressed, as illustrated in the schematic diagram on Figure 4-20. The in-situ soil at the toe is densified and debris left by the drilling process compressed. As a result, greater end bearing resistance is developed at small displacements. The magnitude of pressure that can be applied to the shaft base may be limited by the downward reaction provided by the shaft in side shear.

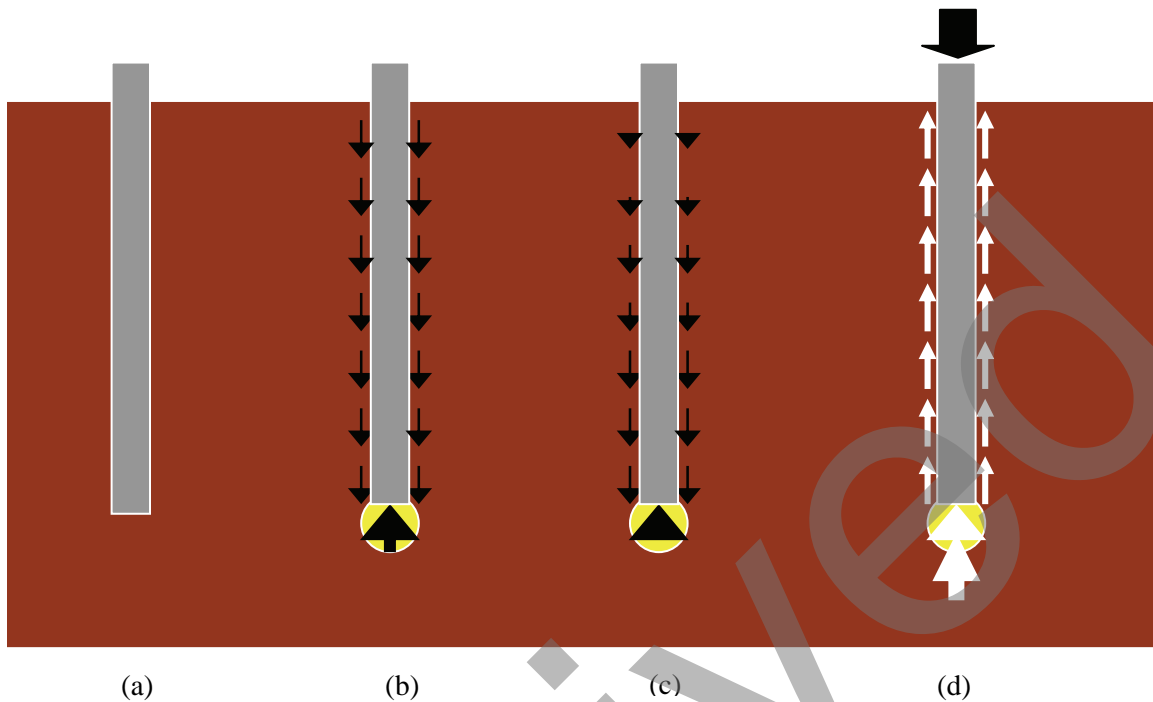


Figure 4-20 Schematic of Base Grouting Process: (a) shaft constructed; (b) grout pressure at base, reacts against side shear; (c) some relaxation occurs, but some preload remains; (d) structural loads on shaft engage side and base resistance

Base grouting mechanisms generally fall into two broad categories: the flat jack, or the tube-a-manchette (also known as a sleeve-port in U.S. practice). These grout delivery systems are typically mounted at the base of the reinforcing cage as shown in the photos of Figure 4-21, with tubes or hoses tied to the cage and extending to the surface for subsequent use. A flat jack usually consists of grout delivery tubes to a steel plate with a rubber membrane wrapped underneath. A tube-a-manchette typically consists of 2 to 4 grout pipe circuits, or “U-tubes”, arranged below the shaft toe in various configurations. U-tubes are perforated for grout release and covered by a tight fitting rubber sleeve to prevent ingress of concrete during placement of the shaft concrete. Sometimes base grouting can be performed after-the-fact by coring to the tip and stem grouting. While this is a viable remediation technique, it is a costly and difficult procedure, particularly for deep shafts. The preferred method for base grouting uses a pre-designed mechanism installed in the cage prior to shaft construction. Grout is mixed and delivered via a high pressure pump as illustrated in Figure 4-22.

The primary objective of the grouting operation is to densify the soils below and around the base of the shaft. A secondary benefit is sometimes achieved by the enlarged area at the base of the shaft that may extend for one diameter or so above the base. Photographs of some base grouted shafts that have been exhumed in Figure 4-23 show the resulting grout bulb at the shaft base.





Figure 4-21 Base Grouting Systems Tied to Reinforcing Cage: Flat-jack method (left) and Tube-a-manchette method (right)



Figure 4-22 Pumping Grout to the Base of the Shaft



Figure 4-23 Exhumed Shafts after Grouting

The grout is typically composed of a neat water-cement mixture, with pressure applied using a simple pump. Pressures at the top of the shaft of up to 800 psi are achievable, provided that the shaft has sufficient reaction in side resistance.

Grout pumping operations typically can be completed within a couple hours, and pumping continues until one of three limiting criteria are encountered:

1. The maximum grout pressure (usually around 800 psi) of the system is reached. Grout pressure should be monitored using a transducer in the delivery line.
2. A large volume of grout has been pumped into the shaft and the pressures are not observed to continue to rise. In general, if a volume equal to that of a 1 to 2 foot length of shaft has been delivered to the base and the pressure is not rising dramatically, then additional grout will not achieve more improvement. In some cases, it is possible to flush the grout system with water and perform multiple stages of grouting to finally achieve higher pressures.
3. The shaft begins to move upward excessively. The maximum reaction in side shear is typically mobilized at an upward displacement of approximately  $\frac{1}{4}$  to  $\frac{1}{2}$  inch. The photo at right in Figure 4-22 illustrates the measurement of upward displacement of a drilled shaft during grouting.

Base grouting may be considered in sandy soils where the shaft is deep enough that the reaction in side resistance is sufficient to develop a significant grout pressure at the base. If the soils at the base are predominantly clay, base grouting may not achieve much improvement in end bearing resistance in comparison with a conventional shaft with good construction practices. Likewise, conventional shafts installed into rock are likely to have large end bearing without base grouting, although grouting can provide benefit in compressing any debris left from imperfect cleaning of the shaft base.

#### **4.6 UNDERREAMS (BELLS)**

An underreamed shaft (also known as a belled shaft) is constructed with an enlarged base diameter in order to achieve greater end bearing resistance than would be obtained with a straight shaft at the same bearing depth. The construction of underreams involves the use of a tool to cut the enlarged base, and can only be performed reliably in materials that will stand open with an undercut hole. The design of this type of foundation relies heavily on end bearing resistance, and therefore difficulties in cleaning the base are an impediment to good performance.

The underream normally has the general conical shape shown in Figure 4-24a, with the maximum diameter of the underream being not more than three times the diameter of the shaft. The shaft is formed initially using conventional excavation methods to the bearing depth, at which time the auger is removed, the belling tool attached, and the soil underreamed to cut the bell.

The use of a bell is applicable only to soil or soft rock that will stand open, that are dry, and which can also be cut by the belling tool. Chalk, marl, very stiff clays, dry cemented sands, and some glacial tills with low permeability are examples of bearing formations that have historically favored belling. Rock formations are often too hard to cut with the belling tool, and also high axial resistance can normally be obtained from a short, straight sided socket. Very stiff clays which have been overconsolidated by desiccation can sometimes have a secondary structure of fissures or slickensides that can result in sloughing of the underream. Bells are not normally constructed underwater; even if the bell were cut into a formation which was stable underwater or under slurry, there is difficulty in removing cuttings and verifying the integrity and cleanliness of the bearing surface.

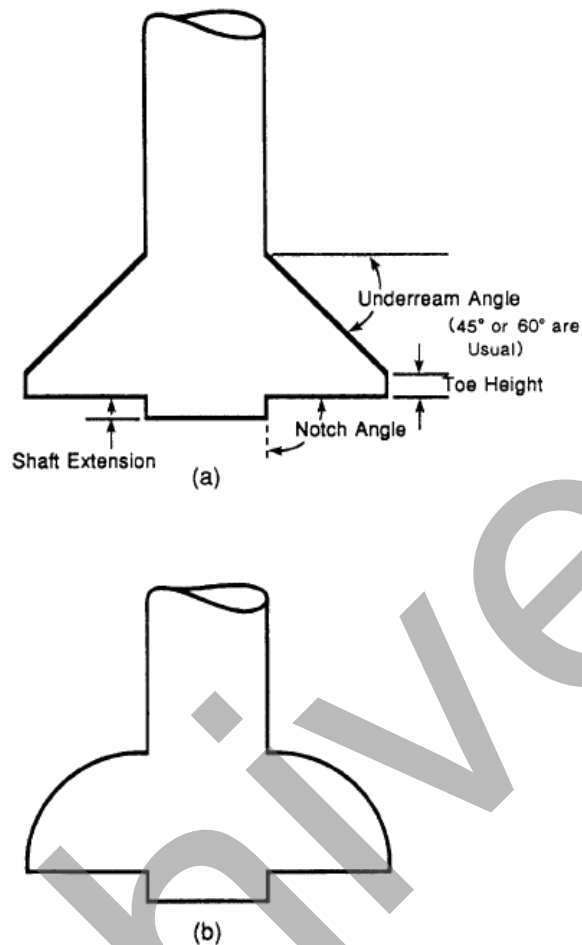


Figure 4-24 Shapes of Typical Underreams: (a) cut with "standard" conical reamer; (b) cut with "bucket," or hemispherical, reamer

Underreamed shafts are not common for transportation projects, but have a history of use in the industry. Because of the reliance on end bearing and the importance of cleaning the base, bells have historically often involved some hand excavation. Safety considerations make hand excavation very undesirable, and so the use of bells has diminished in recent years. In addition, larger and more powerful equipment has made excavation of larger diameter and deeper straight sided shafts more feasible compared to a few decades ago.

The toe height and the underream angle shown in Figure 4-24a are variables. The shaft extension ("reamer seat") in Figure 4-24a is to ensure that the underream is centered and does not wobble during drilling, and to assist in the removal of cuttings. The length of the extension depends on the equipment employed. The notch angle will normally be 90 degrees, but the angle will probably be rounded off in drilling in most soils. The stress concentrations in the vicinity of the extension in the finished bell can limit the bearing load that is placed on an underream.

Conical belling tools have hinged arms that are pushed outward by a downward force on the Kelly (drill rod) so that rotation of the tool in the borehole will cause soil to be cut away. The loose soil is swept to the center of the tool, the base of which contains a bucket for capturing the cuttings. When an upward

force is put on the kelly, the cutter arms are retracted and the underreaming tool is lifted out of the borehole. The spoil is removed from the bucket by unHINGING the bottom of the tool. The excavation of a bell can be a time-consuming process compared to cutting a straight shaft because only a limited amount of soil can be removed at one pass.

Underreams can also be cut with the hemispherical shape shown in Figure 4-24b. The reamer that is used to obtain this shape is called a "bucket" reamer. As may be seen, for the same diameter, more concrete is required for the shape shown in Figure 4-24b than for that shown in Figure 4-24a. Furthermore, the mechanics of the tool that forms hemispherical bells makes it more difficult to sweep cuttings from the bottom of the hole than with the tool for the conical bell. Other underreaming tools have been designed to be guided by the bottom of a casing so that a shaft extension is not required.

A rebar cage, if used, will extend through the center of the shaft and the bell; therefore, the portion of the bell outside of the central shaft normally is not reinforced.

Bells can be cut at either a 45 or 60 degree angle relative to the horizontal, and there are advantages and limitations to each approach. The 60-degree underream will result in lower stresses in the bell at a given pressure, allowing a higher permissible bearing pressure. However, more concrete is required for a 60 degree bell, and the tool is too tall to fit under the rotary table of most mobile truck rigs if the bell diameter exceeds about 90 inches. It is therefore advantageous to use 45-degree belling tools where possible, because they are much shorter and can fit more easily under the turntable of a truck-mounted drill rig. The alternative is to use a crane-mounted drill rig (Chapter 5), which can be equipped with a high turntable, but the cost of using such a rig on a small project may considerably increase the cost of the drilled shafts. Analysis and experience indicates that 45-degree underreams are adequate for most designs if end-bearing stresses are controlled. A discussion is presented in Section 16.8.3 on the bearing stresses that can be permitted for unreinforced bells with bell angles of both 45 and 60 degrees.

If bells are to be considered on a project, a test installation is recommended. Close attention should be given to the belling operation. Not only is there a danger of collapse of the excavation but there is the possibility that loose soil will collect beneath the underreaming tool causing the tool to "ride up," even if the bell is excavated in the dry. The observation of a reference mark on the kelly (the drill rod to which the tool is attached) relative to a surface datum will indicate whether loose soil is collecting below the belling tool as the work progresses. Account should be taken of the downward movement of the kelly as the arms move outward.

Prior to placing concrete in the belled shaft, the bottom must be free of drilling spoils and certified as a competent bearing surface. The inspection of the base of the excavation can be done visually from the ground surface in many instances, but the inspector may sometimes need to enter the excavation, using appropriate safety precautions. This action is generally recommended only where high bearing stresses are employed. If there is concern about the character of the soil or rock below the excavation, a probe hole can be drilled.

#### **4.7 BATTERED SHAFTS**

Drilled shafts installed on a "batter" are inclined with respect to the vertical in order to engage the axial resistance of the shaft to a load which has a large horizontal component. Battered shafts are not normally recommended due to the increased difficulties with construction and limitations of equipment operating at an angle, increased cost associated with drilling at an incline, and increased difficulties with respect to inspection and quality assurance. The consideration of battered drilled shafts should be limited to relatively modest depths (less than about 50 ft) in dry stable soils or soft rock. Drilling at an angle with

the vertical is difficult to control, and the difficulty increases significantly if an underream is required. Temporary casing is also often difficult to extract without causing damage to reinforcing cages or in-place concrete when drilled shafts are placed on a batter.

#### **4.8 SUMMARY**

An understanding of drilled shaft construction is critical to a successful foundation design and execution for the reasons outlined in the introduction to this chapter. Although the means and methods of construction are usually delegated to the contractor (along with the contractual obligation to complete the work in a timely manner), engineers must recognize that construction procedures are critical with regard to the performance of the drilled shafts. The design methods that are presented in this manual generally do not distinguish among construction methods, but assume that good practices are followed. There may be occasions when it is necessary for the designer to specify a particular construction method; for example, use of full-depth casing to protect adjacent structures, but doing so will almost always add significantly to the cost of the job. Similarly, the specifications may exclude one or more methods that the designer considers unsuitable for the existing ground conditions; for example, precluding the use of the dry method of construction where the risk of caving is considered unacceptable, or requiring the use of permanent casing where extremely soft soils are present.

This chapter has provided an overview of general construction methods used for drilled shafts. Subsequent chapters provide more details on the specific issues relating to selection of tools and materials.

Archived

This page is intentional left blank.

## **CHAPTER 5 TOOLS AND EQUIPMENT**

### **5.1 INTRODUCTION**

Most contracts for drilled shaft construction establish that the means and methods are the contractor's responsibility. Therefore, the final choice of the types of drilling rigs and drilling tools that are to be used to make excavations for drilled shafts on a specific project are almost always chosen by the contractor. These choices are made based upon:

- The subsurface conditions that are encountered as a part of the site investigation and presented to bidders via the contract documents. It is therefore critical that sufficient design-phase geotechnical investigations be performed to appropriately characterize the existing subsurface conditions. Also, it is essential that the conditions encountered in the site investigation be conveyed as openly and clearly as possible in the geotechnical report and that this information is available to prospective bidders. If possible, rock cores and soil samples should be made available for inspection by bidders. On large or complex projects (particularly design-build projects), owners may make additional borings upon the request of bidders or bidders may choose to make additional borings or test holes for their own use.
- Additional indications of subsurface conditions that may be revealed as a part of a site visit by the prospective bidder. Therefore, it is important that the site be accessible to potential contractors. In some cases it may be warranted to perform a pre-bid exploratory shaft excavation so that bidders have an opportunity to directly observe conditions in a full size shaft excavation.
- The contractor's personal experience in similar geologic conditions.
- The contractor's available equipment and experience with that equipment.
- The experiences of other contractors in the local area on similar projects and under similar geology, provided that information is available to the contractor. Where a transportation agency has documented information available on previous drilled shaft projects, this information can be extremely valuable in terms of minimizing uncertainty and contingency costs in the bid and in avoiding potential claims. There is great value in post-construction documentation of "lessons learned" for future use by transportation agencies.

The choice of rigs and tools is critical to the success of a project. Sometimes an apparently minor change in a drilling tool can change the rate of excavation dramatically. Because of the importance of selecting proper tools and equipment, it is critical for both engineers and inspectors to understand the general types of rigs and tools available in the United States. Although the burden of risk in the choice of specific tools and equipment is typically the contractor's responsibility, the list above underscores the importance of the engineers and owners in understanding tools and equipment and the information needed by the contractor to make an informed decision.

The following sections describe the drilling machines and tools for excavation of drilled shafts.

### **5.2 DRILLING MACHINES**

The machines used for drilling shaft excavations have evolved over the years from primitive mechanical systems (e.g., Figure 5-1 from the 1930's) supplemented by heavy reliance on manual excavation to

sophisticated and powerful hydraulic machines with extensive in-cab instrumentation and controls. This section provides an overview of the broad range of drilling machines available in current (2009) U.S. practice.

### 5.2.1 Overview of Rotary Systems

Most excavations for drilled shafts in the United States are made by some type of rotary-drilling machine. The machines vary greatly in size and in design as well as by the type of machine on which the drilling rig is mounted. The machine transmits force from the power unit through the rotary to a kelly bar to the tool attached to the end of the kelly as illustrated on Figure 5-2.



Figure 5-1 An Early Drilled Shaft Machine and Crew

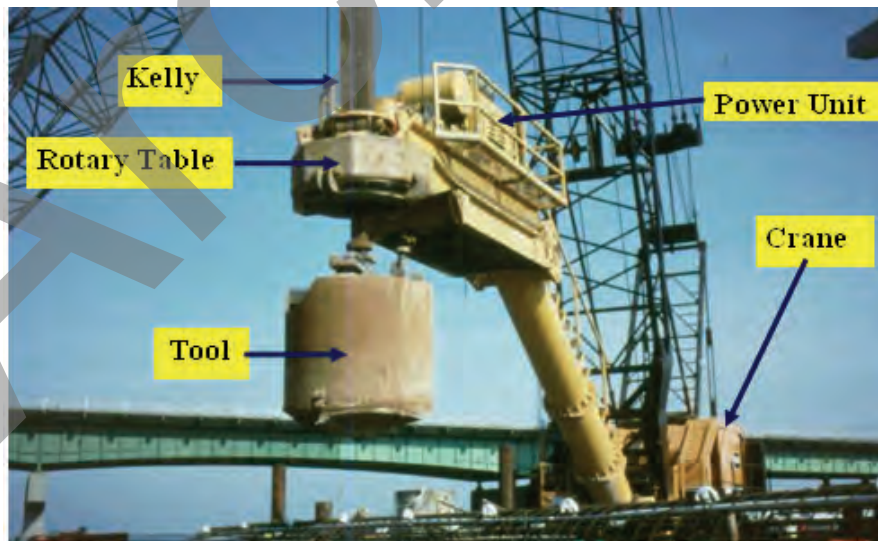


Figure 5-2 Drill Rig Terminology



The capacity of a drilling rig is often expressed in terms of the maximum torque that can be delivered to the drilling tools and the "crowd" or downward force that can be applied. Other factors can have great impact on the efficiency of the rig in making an excavation, particularly the type and details of the drilling tools, but the torque and crowd are important factors affecting the drilling rate.

Torque and crowd are transmitted from the drilling rig to the drilling tool by means of a drive shaft of steel, known as the kelly bar, or simply the "kelly." The drilling tool is mounted on the bottom of the kelly. Kellys are usually either round or square in cross section, and may be composed of a simple single piece (up to about 60 ft long) or may telescope using multiple inner sections to extend the depth to which the kelly can reach. The square kelly bars often require a worker to insert a pin to lock the outer bar to the inner telescoping kelly piece, whereas the round kellys often include an internal locking mechanism. In some rigs the weight of the kelly and the tool provides the crowd. In others, hydraulic or mechanical devices are positioned to add additional downward force during drilling.

Specific details relating to the capabilities of individual drilling machines are readily available on the websites of equipment manufacturers. A contractor will normally provide these details as a part of the drilled shaft installation plan for a specific project.

### **5.2.2 Mechanical vs Hydraulic Systems**

The drilling machines used in the drilled shaft industry are typically powered by either a mechanical system or by hydraulic power. Examples of each type are shown in Figure 5-3.

A typical mechanical drive system delivers power to the rotary via a direct mechanical drive shaft or sometimes a right angle drive from a multiple speed transmission. This type of system has a long history of use, is mechanically simple, and is relatively lightweight. Most lightweight truck-mounted drill rigs use direct drive mechanical systems. Large crane attachments as shown in Figure 5-2 are also direct drive mechanical systems.

Recent years have seen an increase in the use of hydraulic systems to deliver force to the rotary table. The potential high pressures available in modern hydraulic systems can provide rigs with a higher torque range, and the use of the hydraulic drive allows the rotary to move up and down the mast rather than restrained to a location fixed by the drive system. The movable rotary provides versatility in that the rotary can elevate above casing and even be used to install casing. Hydraulic rigs are sometimes heavier and more expensive than a similar size mechanical machine.

Mechanical drive systems often apply crowd through a pull-down system applied to a drive bar atop the kelly, in which the drive bar is guided within the leads as it travels up and down the mast. Although the same crowd system can be applied to a hydraulic driven kelly, more often the crowd in a hydraulic system is applied through the rotary.

### **5.2.3 Methods of Mounting Drilling Machine**

The drilling machine must be mounted on some type of carrier in order to drill and move about the site. The type of carrier has an effect on the versatility of the machine and the efficiency of the overall operation. Drill rigs may be mounted on trucks, crawlers, excavators, cranes, or may even be designed to operate directly as a top drive unit mounted onto a casing. The following sections provide a brief description of drill rigs by methods of mounting the machine.

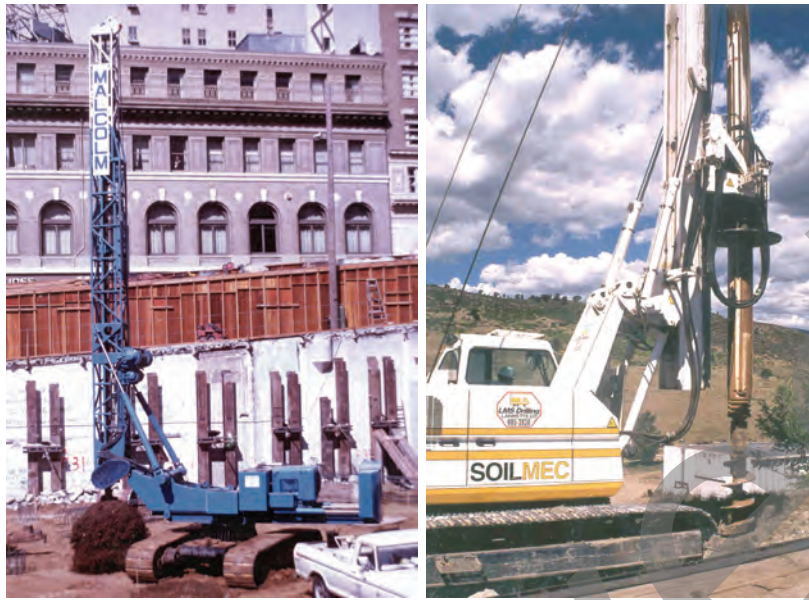


Figure 5-3 Mechanical (left) and Hydraulic (right) Powered Drilling Machines

### 5.2.3.1 Truck Mounted Drilling Machines

Mobility is the greatest advantage of truck-mounted drilling machines, which can range widely in size and drilling capabilities. As shown in Figure 5-4, truck-mounted rigs can range from small, extremely mobile rigs most suited to small holes to large, heavy rigs capable of drilling rock. If the site is accessible to rubber-tired vehicles and conditions are favorable for drilling with truck-mounted rigs, construction of drilled shafts can be accomplished very efficiently with these machines. With the mast or derrick stored in a horizontal position, lighter units can move readily along a roadway. The truck can move to location, erect the derrick, activate hydraulic rams to level the rotary table, and begin drilling within a few minutes of reaching the borehole location.

Truck-mounted rigs are normally mechanically-driven with a fixed rotary, and therefore may have limited capability to reach over tall casing or to handle tall drilling tools. The space below the rotary table can be increased by placing the rig on a ramped platform, but this procedure is obviously slow and expensive and would be used only in unusual circumstances. However, some truck-mounts are now supplied with a hydraulic sliding rotary which can overcome many of the limitations of older truck-mounted rigs.

While the truck-mounted unit has a secondary line with some lifting capacity, that capability is necessarily small because of the limited size of the derrick. The drilling tools can be lifted for attachment to and detachment from the kelly, but, if a rebar cage, tremie or casing must be handled, a service crane is usually necessary. Some truck rigs can handle light rebar cages and tremies of limited length.



Figure 5-4 Truck Mounted Drilling Rigs

### 5.2.3.2 Crane Mounted Drilling Machines

A power unit, rotary table, and kelly can be mounted separately on a crane of the contractor's choice, as shown in Figure 5-5. Crane mounted drill rigs can have substantial capabilities and versatility on a bridge project, especially over water. The crane-mounted machine is obviously less mobile than a truck unit. Mobilization to the jobsite generally requires "rigging" or assembly of the equipment with significant cost and effort.

Power units of various sizes can be utilized to supply large torque at slow rotational speeds to the drilling tool. Usually, the downward force on the tool is due to the dead weight of the drill string, but the dead weight can be increased by use of heavy drill pipe (drill collars), "doughnuts," or a heavy cylinder. Special rigging is available for crane machines that will apply a crowd for drilling in hard rock. The cross-sectional area of the kelly can be increased to accommodate high crowds.

The framework or "bridge" that is used to support the power unit and rotary table can vary widely. The rotary table may be positioned 75 ft or more from the base of the boom of a crane by using an extended mount. The ability to reach to access the hole from a distance makes crane mounted machines very attractive in marine construction when working from a barge or work trestle. The bridge for the drilling unit can also be constructed in such a way that a tool of almost any height can fit beneath the rotary table. Therefore, crane-mounted units with high bridges can be used to work casing into the ground while drilling or for accommodating tall drilling tools.

A service crane or the drilling crane itself is used on the construction site for handling rebar cages, tremies, concrete buckets and casings. The secondary lift line on the drilling crane can be used for common lifting by tilting the derrick forward and away from the rotary table, thus making the crane-mounted drilling unit a highly versatile tool.



Figure 5-5 Crane Mounted Drilling Rig

### 5.2.3.3 Crawler Mounted Drilling Machines

Crawler mounted drilling machines may be less mobile than truck mounted equipment for accessible sites, but can provide excellent mobility on the jobsite. Compared to a crane mounted rig, the drilling equipment is usually a permanent fixture on the crawler with a fixed mast serving as the lead for the rotary or kelly guide system. The crawler mount is the most common system used for hydraulic powered rigs, although it is also a popular system for conventional mechanical rigs; both types were shown mounted on crawler equipment in Figure 5-3.

Lightweight crawler mounted drilling machines can be extremely versatile for work on difficult to access sites for applications such as slope stabilization, sound wall foundations, and foundations for signs, towers, or transmission lines. An example of a mobile crawler mounted drill rig is shown in Figure 5-6.

### 5.2.3.4 Excavator Mounted Drilling Machines

Another type of crawler mount that has advantages for some special applications is the placement of the drilling machine on the arm of an excavator as shown in several examples in Figure 5-7. These rigs are almost always hydraulic, utilizing the hydraulic system common on an excavator. The advantage of such a mount is that the rig can reach a difficult to access location with low headroom or with limited access immediately adjacent to the hole. Low headroom equipment is often advantageous for applications such as a sound wall where utility lines are overhead or when installing shafts below or very near an existing bridge structure. The use of low headroom equipment has obvious limitations in terms of the depth and size of hole that can be drilled efficiently. Reduced productivity in drilling under low overhead conditions will affect costs.



Figure 5-6 Crawler Mounted Drilling Rig



Figure 5-7 Excavator Mounted Drilling Machines for Restricted Overhead Conditions

### 5.2.3.5 Oscillator/Rotator Systems

Oscillator and rotator systems are hydraulic-driven tools for advancing and extracting casing. The casing often is a segmental pipe with bolted joints. The oscillator or rotator grips the casing with powerful hydraulic-driven jaws and twists the pipe while other hydraulic cylinders apply upward or downward force. An oscillator twists back and forth, while a rotator (a more expensive machine) can rotate the casing through a full 360° when advancing casing. An example of an oscillator is shown in Figure 5-8 and a rotator is shown in Figure 5-9.



Figure 5-8 Oscillator Machine



Figure 5-9 Rotator Machine

The tremendous twisting force of these powerful machines must be resisted by a reaction system. The oscillator in Figure 5-8 is mounted on a template and frame supported by four steel pipe piles. The rotator torque in Figure 5-9 is resisted by an arm extending to a large crane, and this crane uses dead weight to provide friction of the tracks on the pile-supported platform below. The vertical force acting to push the casing down is normally restricted to the dead weight of the casing plus machine, but the vertical force to pull the casing out (which may be much larger, after the casing is embedded into the soil and may be partially or completely filled with concrete) must be resisted by a reaction system or the bearing capacity of the ground surface. The axial and torque capacity of the entire reaction system must be carefully designed (normally by the contractor) to be sufficient for the machine to work efficiently.

Excavation within the casing is often made using a clam or hammergrab, although a rotary drilling machine can be mounted on the casing to operate as a top-drive unit. It is also possible to excavate sand within the casing using a dredge pump or airlift system. Care must be used so as not to dredge sand below the casing, and as with any type of circulation drilling (discussed in the following section), fluid must be pumped into the casing sufficiently fast as to maintain a head of water. The oscillator/rotator systems are often used with a fully cased hole, although the drilled shaft excavation can be extended into rock or stable soils below the bottom of the casing.

#### **5.2.3.6 Casing Mounted Top-Drive Systems**

Casing mounted top-drive systems are used with reverse circulation drilling, since the rotary machine is mounted on the casing itself. The basic principle of reverse circulation drilling was described in Chapter 4. The full-face rotary cutting head breaks up the soil or rock and an airlift system pumps the drilling fluid containing spoil away from the cutting surface. The drilling fluid is then circulated through a desander and/or settling basin, and returned to the shaft excavation. Slurry or water may be used as the drilling fluid, depending upon the stability of the hole and the length of casing. Examples of top-drive systems are shown in the photos of Figure 5-10. The photo on the left shows the machine during operation with the circulation system in place; cuttings are lifted from the bottom of the excavation through the central pipe, through the swivel at the top of the drill string, and through the discharge hose to a spoil barge. As the hole is advanced, short sections of drill pipe are added. The photo at right shows the top drive system rotated from vertical so that the drill string can be removed or inserted. Cutting heads are shown on Figure 5-11.

The top-drive system mounted on the casing must react against the casing during drilling, so the casing must be sufficiently embedded into firm soil to provide a stable platform on which the machine can work. The excavation below the casing must be stable not only for support of the casing, but also to avoid the collapse of debris into the hole above the cutting head that could make the cutting head difficult or impossible to retrieve. The casing may be installed using a vibratory or impact hammer, or using an oscillator/rotator.

#### **5.2.4 Other Excavation Systems**

Although the vast majority of drilled shafts are excavated using rotary machines, other systems may be employed to advance an excavation into the subsurface for a wall or foundation. These include manual techniques and excavation using grab tools or slurry wall equipment.



Figure 5-10 Top-Drive Reverse Circulation Drill



Figure 5-11 Reverse Circulation Cutting Heads for Top-Drive Drill



Manual excavation (Figure 5-12), i.e., vertical mining, has been employed for many years and is still a viable technology in some circumstances, such as for underpinning of existing structures. Excavation using workers below ground obviously requires great attention to safety considerations and is usually quite expensive compared with alternatives. Manual excavation is usually only considered where mechanized equipment is ineffective or where the location is inaccessible, such as to remove a boulder or rock or in a confined space where a heavy machine cannot be positioned. For dry excavations into very strong rock, there may be circumstances where hand labor is cheaper and faster. If bells are to be cut into shale with limestone stringers, for example, it may be desirable for workers to excavate the bell by hand with the use of air hammers. Hand excavation is also sometimes employed when it is necessary to penetrate steeply sloping rock, as in a formation of pinnacled limestone, where ordinary drilling tools cannot make a purchase into the rock surface.

Safety precautions must be strictly enforced when hand mining is employed. The overburden soil must be restrained against collapse, the water table must be lowered if necessary, and fresh air must be circulated to the bottom of the hole.



Figure 5-12 Manual Excavation in Rock

Other non-rotary excavation techniques may include the use of a grab or clam or hydromill, as in the construction of rectangular diaphragm wall panels. When used as a foundation, an individual panel is often referred to as a “barrette”. These panels can be efficiently oriented to resist large horizontal shear and overturning forces in addition to axial loads, and can even be post-grouted to enhance capacity. The use and testing of barrette foundations in Hong Kong is summarized by Ng and Lei (2003). A barrette is typically excavated under slurry to maintain stability of the excavation.

Photos of a clam system are shown in Figure 5-13; these may have a hydraulically controlled guide system to maintain alignment. Photos of a hydromill (or hydrofraise, as it is known in Europe) are illustrated in Figure 5-14. A hydromill or “cutter” is typically used to excavate rock, and cuts the rock with two counter-rotating wheels at the base of the machine. The excavated materials are lifted from the cutting face using an airlift or pump to circulate the slurry similar to the reverse circulation drill described in Section 5.2.3.6.



Figure 5-13 Excavation of a Diaphragm Wall or Barrette Using a Clam

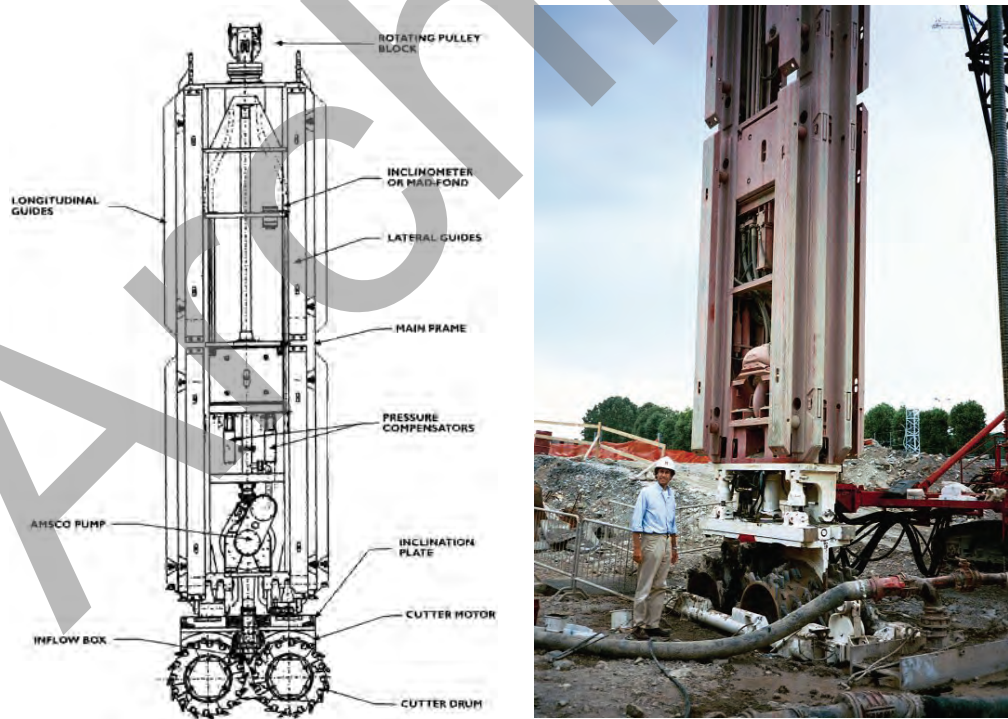


Figure 5-14 Excavation of a Diaphragm Wall or Barrette Using a Hydromill

Rodless drilling machines have been developed in Japan that can be used in certain cases to solve difficult problems. One type that has been used to excavate circular holes consists of down-the-hole motors that drive excavating cutters that rotate in a column of bentonite drilling slurry. The cutters are designed to gouge the soil from the bottom of the excavation and push it to the center of the excavation, where it is then sucked into a flexible return line with the slurry and transported to the surface. The machine is handled with a cable; therefore, it is not necessary to have a high derrick. Other versions of the rodless drill (termed the "Mach Drill" by the manufacturer) include a series of hydraulically-operated hammers with button teeth that pulverize the rock and rotate to push the pulverized rock to the center of the excavation, where the rock fragments are removed by the reverse circulation process.

### **5.2.5 Summary**

This section outlines what may appear to be a dizzying array of choices of machines for excavating a drilled shaft. The variety of machines available to contractors reflects the maturation of the foundation drilling industry and the development of specialized equipment to optimize productivity for particular applications. The range of mounting systems for the drilling machines and torque and crowd capabilities of modern equipment has extended the size, depth, and potential applications of drilled shaft foundations far beyond those considered feasible a few decades ago. Still, the basic concept used to construct the majority of drilled foundations for transportation structures is that of a simple rotary drilling machine turning a tool at the bottom of a hole and removing soil or rock one auger or bucketful at a time. Although the capabilities of the drilling machine are critical to the ability of the constructor to complete the drilled shaft excavation to the size and depth required, the choice of drilling tools is often as (or more) important to the productivity of the excavation process. Drilling tools are discussed in the following section.

## **5.3 TOOLS FOR EXCAVATION**

### **5.3.1 Rotary Tools**

The tool selected for rotary drilling may be any one of several types, depending on the type of soil or rock to be excavated. Rotary tools described in this section include augers, buckets, coring barrels, full faced rotary rock tools, and other specialized rotary tools for drilling soil and rock. The tools for rotary drilling are typically available in sizes that vary in 6 inch increments up to approximately 10 ft in diameter. Larger sizes are available for special cases.

Often, small details in the design of a tool can make a huge difference in effectiveness. For example, it is necessary that the lower portion of the tool cut a hole slightly larger than the upper part of the tool to prevent binding and excessive friction. It would not be unusual for one driller to reach refusal with a particular tool while another driller could start making good progress with only a slight adjustment to the same tool. Different contractors and drillers will select different tools for a particular task and in many instances will have their own particular way of setting up and operating the tool. Important details in apparently similar tools may vary, and it is not possible to describe all "standard" tools that are in use in the industry.

The following paragraphs give brief descriptions of some of the common tools used in rotary drilling.

### 5.3.1.1 Augers

This type of drilling tool can be used to drill a hole in a variety of soil and rock types and conditions. It is most effective in soils or rocks that have some degree of cohesion. The auger is equipped with a cutting edge that during rotation breaks the soil or rips the rock, after which the cuttings travel up the flights. The auger is then withdrawn from the hole, bringing the cuttings with it, and emptied by spinning. Difficulties can be encountered when drilling in cohesionless sands where soil slides off the auger flights, or in some cohesive soils where the tool can become clogged.

Augers for drilling soils and rocks vary significantly depending upon the type of material to be excavated. The following sections describe various types of augers used in foundation drilling.

#### 5.3.1.1.1 Earth Augers

Earth augers may have a single or double cutting surface, as shown in Figure 5-15 and 5-16, respectively, and many have a central point or "stinger" that prevents the auger from wobbling. Double-flight augers are usually used for excavating stronger geomaterials than are excavated with single-flight augers. Some augers may be true double flight augers as on the right of Figure 5-16, and some may have a "dummy flight" to provide a double cutting surface but feed the cuttings into a single auger flight. The stinger for a single-flight auger is typically more substantial than for an auger with a double cutting surface because the single-flight auger must sustain a greater unbalanced moment while the geomaterial is being cut. Double flight augers are generally preferred for large diameter holes (Figure 5-17) so that the cutting resistance on the base of the tool is more evenly balanced. Some contractors have found that double-flight augers without stingers can be used efficiently.



Figure 5-15 Single Flight Earth Augers



Figure 5-16 Double Flight Earth Augers



Figure 5-17 Large Diameter Auger with Double Cutting Edge

The flighting for augers must be carefully designed so that the material that is cut can move up the auger without undue resistance. Some contractors have found that augers with a slight cup shape are more effective at holding soils when drilling under slurry than standard non-cupped augers. The number and pitch of the flights can vary widely. The type of auger, single-flight or double-flight, cupping, and the number and pitch of flights will be selected after taking into account the nature of the soil to be excavated. The length of the auger affects the amount of material that may be excavated in one pass, and the maximum length may be limited by the capability of the drilling machine. Longer augers also tend to drill straighter holes, but are heavier to hoist.

The cutting face on most augers is such that a roughly flat base in the borehole results (that is, the cutting face is perpendicular to the axis of the tool). The teeth in Figure 5-15 and 5-16 are flat-nosed for excavating soil or decomposed rock, whereas the rounded teeth in Figure 5-17 are for ripping harder material. The shape and pitch of flat-nosed teeth can be varied; modifying the pitch on auger teeth by a few degrees can make a significant difference in the rate at which soil or rock can be excavated, and the contractor may have to experiment with the pitch and type of teeth on a project before reaching optimum drilling conditions.

An important detail, particularly in soils or rocks containing or derived from clay, is that softened soil or degraded rock is often smeared on the sides of otherwise dry boreholes by augers as the cuttings are being brought to the surface in the flights of the auger. This smeared material is most troublesome when some free water exists in the borehole, either through seeps from the formation being drilled or from water that is introduced by the contractor to make the cuttings sticky and thus facilitate lifting. Soil smear can significantly reduce the side resistance of drilled shafts, particularly in rock sockets. A simple way to remove such smear is to reposition the outermost teeth on the auger so that they face to the outside, instead of downward, and to insert the auger and rotate it to scrape the smeared material off the side of the borehole prior to final cleanout and concreting.

Care must be exercised in inserting and extracting augers from columns of drilling slurry, as the slurry is prone to development of positive (insertion) and negative (extraction) pressures that can destabilize the borehole. The addition of teeth on the side of the auger to excavate a hole larger than the size of the tool can be beneficial in allowing slurry to pass. The tool may also be equipped with one or more slurry bypass ports; the tool shown in the foreground of Figure 5-18 incorporates a slurry bypass sleeve around the kelly connection.



Figure 5-18 Auger with Slurry Bypass

Cobbles or small boulders can sometimes be excavated by conventional augers. Modified single-helix augers (Figure 5-19), designed with a taper and sometimes with a calyx bucket mounted on the top of the auger, called "boulder rooters," can often be more successful at extracting small boulders than standard digging augers. The extraction of a large boulder or rock fragment can cause considerable difficulty, however. If a boulder is solidly embedded, it can be cored. When boulders are loosely embedded in soil, coring may be ineffective. The removal of such boulders may require that the boulders be broken by impact or even by hand. A boulder can sometimes be lifted from the excavation with a grab, or by cable after a rock bolt has been attached.

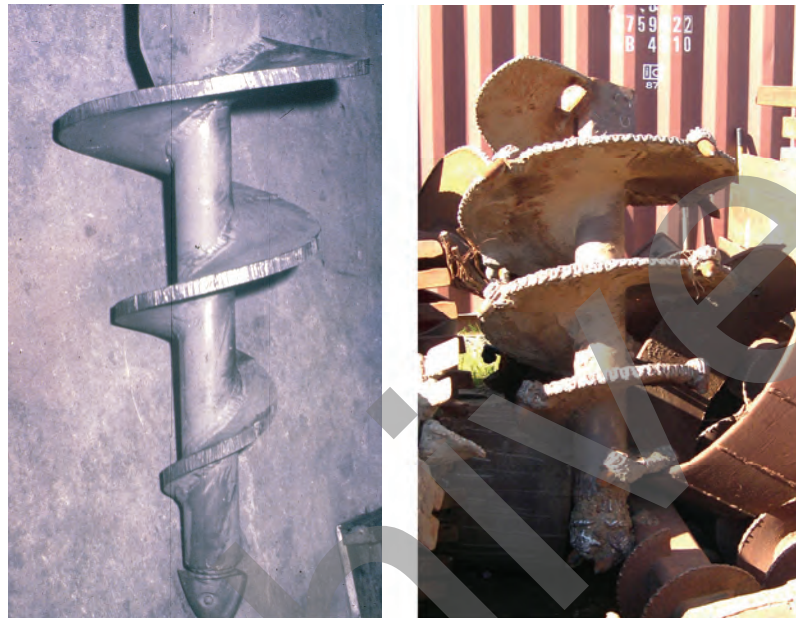


Figure 5-19 Boulder Rooters

#### 5.3.1.1.2 Rock Augers

A flight auger specially designed for rock can also be used to drill relatively soft rock (hard shale, sandstone, soft limestone, decomposed rock). Hard-surfaced, conical teeth, usually made of tungsten carbide, are used with the rock auger. Rock augers are often of the double-helix type. Three different rock augers are shown in Figure 5-20. As may be seen in the figure, the thickness of the metal used in making the flights is more substantial than that used in making augers for excavating soil. The geometry and pitch of the teeth are important details in the success of the excavation process, and the orientation of the teeth on a rock auger is usually designed to promote chipping of rock fragments. Rock augers can also be tapered, as shown in Figure 5-20.

Some contractors may choose to make pilot holes in rock with a tapered auger of a diameter smaller than (perhaps one-half of) that of the borehole. Then, the hole is excavated to its final, nominal diameter with a larger diameter, flat-bottom rock auger or with a core barrel. The stress relief afforded by pilot-hole drilling often makes the final excavation proceed much more easily than it would had the pilot hole not been made. It should be noted that tapered rock augers will not produce a flat-bottomed borehole, and an unlevel base in the borehole can be more difficult to clean and to produce a sound bearing surface.



Figure 5-20 Rock Augers

### 5.3.1.2 Drilling Buckets

Drilling buckets are used mainly in soil formations, as they are not effective in excavating rock. Soil is forced by the rotary digging action to enter the bucket through the two openings (slots) in the bottom; flaps inside the bucket prevent the soil from falling out through the slots. A typical drilling bucket is shown in Figure 5-21. After obtaining a load of soil, the tool is withdrawn from the hole, and the hinged bottom of the bucket is opened to empty the spoil. Drilling buckets are particularly efficient in granular soils, where an open-helix auger cannot bring the soils out.

They are also effective in excavating soils under drilling slurries, where soils tend to "slide off" of open helix augers. When used to excavate soil under slurry, the drilling bucket should have channels through which the slurry can freely pass without building up excess positive or negative pressures in the slurry column below the tool. It is often easier to provide such pressure relief on drilling buckets than on open-helix augers.



The cutting teeth on the buckets in Figure 5-21 are flat-nosed. These teeth effectively "gouge" the soil out of the formation. If layers of cemented soil or rock are known to exist within the soil matrix, conical, or "ripping," teeth might be substituted for one of the rows of flat-nosed teeth to facilitate drilling through alternating layers of soil and rock without changing drilling tools.



Figure 5-21 Typical Drilling Buckets

Drilling buckets are generally not appropriate for cleaning the bases of boreholes. Other buckets are designed to clean the base when there is water or drilling slurry in the hole (Figure 5-22). These are known as "muck buckets" or "clean-out buckets." Clean-out buckets have cutting blades, rather than teeth, to achieve more effective removal of cuttings. The operation of the closure flaps on the clean-out bucket, or steel plates that serve the same purpose as flaps, are critical for proper operation of the clean-out bucket. If such flaps or plates do not close tightly and allow soil to fall out of the bucket, the base cleaning operation will not be successful. As with drilling buckets, clean-out buckets should be equipped with channels for pressure relief if they are used to clean boreholes under slurry.



Figure 5-22 Clean-out Buckets

### 5.3.1.3 Core Barrels

If augers are ineffective in excavating rock (for example, the rock is too hard), most contractors would next attempt to excavate the rock with a core barrel. Coring can be more effective in loading the individual cutting bits since the load is distributed from the crowd to the perimeter rather than to the entire face of the hole. Ideally, the tube cores into the rock until a discontinuity is reached and the core breaks off. The section of rock contained in the tube, or "core," is held in place by friction from the cuttings and is brought to the surface by simply lifting the core barrel. The core is then deposited on the surface by shaking or hammering the core barrel or occasionally by using a chisel to split the core within the core barrel to allow it to drop out.

The simplest form of core barrel is a single, cylindrical steel tube with hard metal teeth at the bottom edge to cut into the rock, as illustrated in Figure 5-23. These simple core barrels have no direct means to remove rock chips from the cutting surface. The tools in these photos include a variety of cutting teeth positioned in a staggered pattern designed to avoid tracking in the same groove and to cut a hole slightly larger than the tool. The chisel teeth shown at bottom left would be used in soft rock, while the conical points shown at bottom right would be used in somewhat harder material. The "button" teeth shown at center right are used to cut harder rock where the conical points are prone to breaking off. Note also that the oscillator/rotator casing is a type of core barrel which commonly employs the button teeth, as shown in the top most photos.

If the rock is hard and a significant penetration into the rock is required, a double walled core barrel may be more effective. Double walled coring tools are more expensive and sophisticated and can incorporate roller bits as well as teeth. Some examples are shown in Figure 5-24. The cuttings are removed by circulation of air if a dry hole is being excavated or by circulation of water in a wet hole. The double wall provides a space through which the drilling fluid is pumped to the cutting surface. Double-walled core barrels are generally capable of extracting longer cores than single-walled core barrels, which constantly twist and fracture the rock without the provision of fluid to remove cuttings.



Figure 5-23 Single Wall Core Barrels



Figure 5-24 Double Wall Core Barrels



Figure 5-25 Rock Cores

One of the problems with the use of the core barrel is to loosen and recover the core (Figure 5-25) after the core barrel has penetrated a few feet. Various techniques can be used for such a purpose. If the core breaks at a horizontal seam in the rock, drillers may be able to lift the core directly or by a rapid turning of the tool. Note the rock core contained within the barrel in the photo at bottom right of Figure 5-24. When the core does not come up with the barrel, a chisel (wedge-shaped tool) can be lowered and driven into the annular space cut by the core barrel either to break the core off or to break it into smaller pieces for removal with another piece of equipment. Chisels and other percussion tools are described in a

following section of this chapter. If the hole is dry and not too deep, a worker protected by a casing can be lowered to attach a line to the core for removal by a crane. Blasting may also be employed to break up a core, where permitted. A hammergrab or clamshell can be used to lift loose or broken cores, if necessary.

An older coring technique that may sometimes still be used is a "shot barrel". A shot barrel is similar to a core barrel but with a plain bottom. Hard steel shot are fed below the base of the rotating core barrel so as to grind away even the hardest rock.

#### 5.3.1.4 Full-Faced Rotary Tools

Full face rotary tools may be used for drilling rock, particularly at a large depth. Figure 5-26 shows some tools that are used for this purpose and which utilize roller bits that are attached across the entire face of the body of the tool. The roller bits grind the rock, which is transported to the surface by flushing drilling fluid with the reverse circulation technique described earlier. Disk shaped cutter heads or even teeth have been employed with full face tools in soft rock or cemented soils. Full face rotary tools have occasionally been used with direct circulation in small diameter holes (less than 30 inch) in hard rock by forcing compressed air down through the center of the drill string to blow cuttings out.



Figure 5-26 Full-Faced Rotary Cutters

#### 5.3.1.5 Belling Buckets

A special tool has been designed to increase the bearing area and the load capacity of a drilled shaft by forming an enlarged base, or a "bell," as described in Chapter 4. This tool, called a belling bucket or under-reamer (Figure 5-27), is designed to be lowered into the hole on the kelly with its arms closed as shown at left in Figure 5-27. The reamer, with arms extended as it would appear in the drilling position is shown at right in Figure 5-27. Upon reaching the bottom of the shaft, the downward force applied by the drilling machine forces the arms to open and the soil is cut while the tool is rotated. The cuttings are

collected inside the tool and brought to the ground surface for emptying. This process continues until the arms reach a stop, resulting in a fully-formed bell with a predetermined angle and bell dimensions. Commercially available belling buckets cut 60-degree under-reams (sides of the bell make an angle of 60 degrees with the horizontal) and 45-degree under-reams, or the tools can be adjusted by the contractor to cut other angles. The bell diameter should generally not exceed three times the shaft diameter.



Figure 5-27 Belling Buckets

It should be noted that hand cleaning has often been employed to remove debris from the base of the bell and provide a clean bearing surface. It can be difficult to completely remove the cuttings from the base of a bell without the use of downhole entry, and for this reason and others (such as the risk of caving with bells and the greater availability of larger diameter straight shafts), balled shafts are typically not used for transportation structures.

#### 5.3.1.6 Special Rotary Tools

Innovative equipment suppliers and contractors have developed a large number of special tools for unusual problems that are encountered. The tool on the left in Figure 5-28 cuts grooves in the walls of the borehole in order to facilitate development of the shearing strength of the soil or rock along the sides of the drilled shaft. The core barrel on the right in Figure 5-28 has been outfitted with steel wire on the outside of the barrel to scrape cuttings or loose rock (usually degradable shale) from the surface of rock sockets. Such devices are known regionally as "backscratchers." Other tools are used for assistance in excavation. For example, Figure 5-29 shows a drawing and photo of a tool (the "Glover Rock-Grab") that can core and subsequently grab rock to lift it to the surface. This tool is sometimes effective in excavating boulders or fragmented rock where augers or ordinary core barrels are unsuccessful. Numerous other special tools may be developed by equipment suppliers or contractors for specific projects.



Figure 5-28 Special Rotary Tools: Grooving Tool (left) and “Backscratcher” (right)

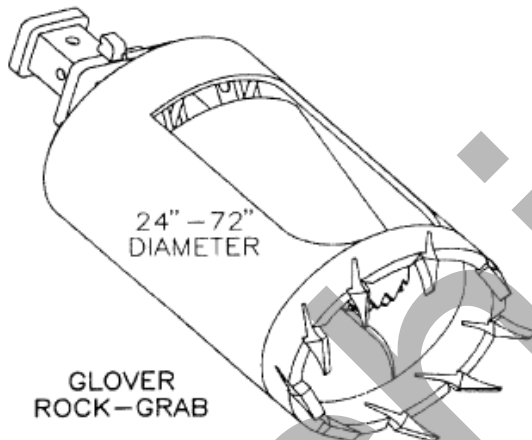


Figure 5-29 Boulder-Grabber Tool

### 5.3.2 Percussion and Other Tools

In contrast to rotary drilling, percussion drilling involves the breaking up of rock or soil by impact. The broken material may be removed with a clamshell-type bucket or other means such as air circulation. The tools used with percussion methods range from the most simple and crude drop tools to sophisticated hammer drills.

#### 5.3.2.1 Clamshell or Grab Bucket

Bucket excavation is initiated by the setting of a guide for the tools, a procedure that corresponds to the setting of a surface casing when rotary methods are being used. The guide may be circular or rectangular and is designed to conform to the excavating tool. The cross sections of such excavations can have a variety of shapes and can be quite large. With the oscillator or rotator systems (Section 5.2.3.5), the circular segmental casing serves as the guide. With the types of clamshell tools used to construct diaphragm walls or barrettes (Section 5.2.4), a guide-wall is often constructed at the ground surface.

Two types of lifting machines may be used to handle the digging tools that are needed for non-rotary excavation. The simplest procedure is to raise and lower the tools with a cable such as provided by a crane (the term "cable tool" is often used to describe tools used in this manner). The jaws of the digging bucket can be opened and closed by a mechanical arrangement that is actuated by a second cable or by a hydraulic system. The other type of lifting machine uses a solid rod for moving the excavating tools up and down. The rod, which may be called a kelly, is substantial enough to allow the easy positioning of the tool. The kelly in this case does not rotate but merely moves up and down in appropriate guides. As with the cable tool, a mechanism must be provided for opening and closing the jaws of the bucket.

Clamshell or grab buckets are often used in situations where rotary tools are unproductive or impractical. For example, a digging bucket can be used to excavate broken rock, cobbles and soils that are loose and that can be readily picked up by the bucket. If hard, massive rock or boulders are encountered, a tool such as a rock breaker may be used. The broken rock is then lifted using a clamshell or a grab bucket. A typical clamshell, with a circular section for use in drilled shafts, is shown on the left in Figure 5-30. Clamshells and grab buckets are available in various diameters up to about 6 ft. Clamshells or grab buckets can also be used to make excavations with noncircular cross sections, as shown at right in Figure 5-30. The transverse dimension of the tool must conform to the shape of the guides that are used.



Figure 5-30 Clam-shell Buckets

### 5.3.2.2 Hammergrabs

Hammergrabs are percussion tools that both break and lift rock. Examples of hammergrabs in use are shown in Figure 5-31. Hammergrabs are made heavy by the use of dead weight. The jaws at the bottom of the tool are closed when the tool is dropped, and the wedge formed by the closed jaws breaks the rock. The jaws have strong, hardened teeth and they can open to the full size of the tool to pick up the broken rock. Hammergrabs are heavy and relatively expensive devices; however, they have the advantage over rock breakers and clamshells in that the tool does not need to be changed to lift out the broken rock, which speeds the excavation process. Hammergrabs can also be used to construct noncircular barrettes by changing the length of the long side.





Figure 5-31 Hammergrabs

### 5.3.2.3 Rock Breakers and Drop Chisels

These types of tools are generally composed of a heavy object that is lifted and dropped to break up boulders, cores, and strong soils in order to break up the material and permit it to be lifted by a clamshell or a grab bucket. These tools may even be used to break rock at the bottom of the hole in order to advance the hole more easily. Several types of tools are made to be dropped by a crane. The chisels shown at the top of Figure 5-32 have a single point designed to help break off a core or to break off a boulder or ledge on the side of the hole. Some examples of rock breakers shown at the bottom of Figure 5-32 are referred to as a "churn drill" or a "star drill." The bottom of these tools has a wedge shape so that high stresses will occur in the rock that is being impacted by the tool.

After the rock is broken, the broken pieces may be removed with a clam or hammergrab, or sometimes with a rotary auger.

### 5.3.2.4 Downhole Impact Hammers

The simplest use of an air-operated impact hammer is accomplished by an individual worker operating at the bottom of the hole with a jack-hammer. This method may be employed to remove boulders or rock fragments in relatively shallow, dry holes where downhole entry can be performed safely. An individual worker has the ability to place the tool in exactly the spot needed and can sometimes provide the most efficient means of advancing the hole. At shallow depths in large diameter holes, it may be possible to employ a larger impact tool from the arm of a backhoe excavator, often referred to as a "hoe-ram".



Figure 5-32 Drop Chisels and Rock Breakers

To excavate hard rock across the full face of the shaft, a large diameter downhole hammer can be used in a drilling operation to make an excavation up to 6 ft in diameter through very hard rock such as granite. Examples of downhole hammers are shown in Figure 5-33. The tool at left is a cluster of air-operated hammers, sometimes referred to as a “cluster drill” Downhole hammers are typically employed for rock which has proven extremely difficult to remove by core barrels or other means. The debris is typically raised by the use of air (i.e., debris is blown out of the borehole) if the hole is dry. The excavation of rock in such a manner is obviously extremely expensive and rock sockets in such hard material are best avoided, especially in urban environments where rock dust can create a hazard.

### 5.3.2.5 Blasting

Blasting is usually not permitted for excavation of drilled shafts because of the safety hazard and because of the potential for fracturing of the surrounding bearing formation. Fractures in the rock around the shaft could be detrimental to the performance of the foundation.

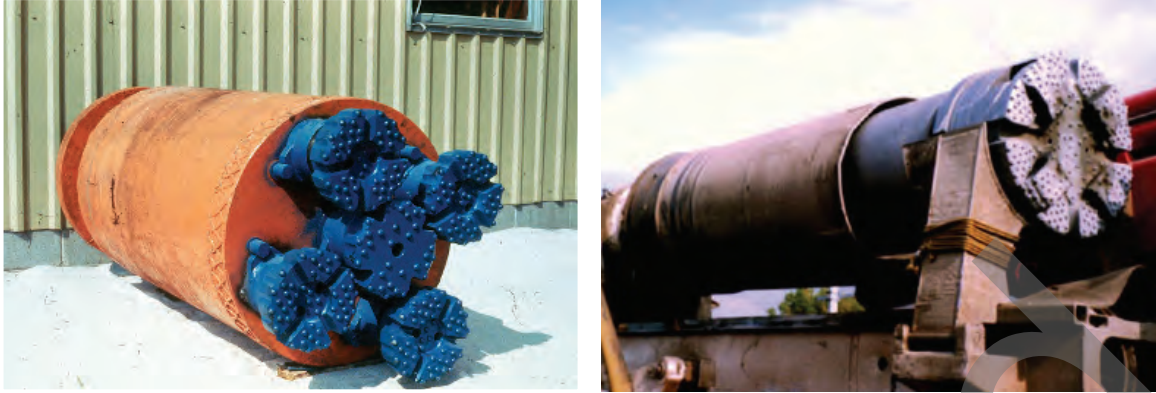


Figure 5-33 Downhole Impact Hammers

Explosives may be considered on rare occasions to aid in hand excavation of rock near the surface. For instance, explosives might be used to break through a boulder or obstruction within the hole. Explosives might also be employed through small predrilled holes to help level a steeply sloping surface and allow a casing to be more easily seated, or through hard pinnacle limestone above the zone relied upon for capacity. Primer cord has reportedly been used successfully to break cores away in the shaft by wrapping the cord around the base of the core at the bottom of the kerf. This small shock is not thought to affect the surrounding rock. Highly expansive cements have on occasion been used as alternates to explosives by placing cement paste in small holes drilled using air tracks into rock to split the rock and permit it to be excavated easily.

Explosives must be handled by experts and should be used only with the permission of the regulating authorities.

## 5.4 OTHER TECHNIQUES

### 5.4.1 Tools for Cleaning the Base of the Drilled Shaft Excavation

Other than the cleanout buckets described in Section 5.3.1.2, other non-rotary tools may be very useful for removing cuttings and debris from the base of the shaft. Most common is some type of pump to lift cuttings for removal. Figure 5-34 illustrates two types of pumps used to lift cuttings. The one on the left is an air-lift pump which operates by pumping air down the supply line alongside the air-lift pipe. As the air enters the pipe a few feet above the bottom, the rising column of air lifts the fluid within the pipe. The buoyant lifting of this column causes suction at the bottom of the pipe which will lift sand or loose material. The photo on the right of Figure 5-34 is of a hydraulic pump, which operates via the two hydraulic lines to rotate the impeller that pumps fluid upward from the base of the pump. Hydraulic pumps are more controllable than the airlift system in that the volume and velocity of pumping can be regulated more easily. Airlifts tend to remove larger particles than pumps.

Note that while pumping systems as shown in Figure 5-34 are probably the most effective means of removing loose cuttings or debris from the base of a wet hole, the aggressive use of these tools in cohesionless sands can advance the shaft excavation. The effectiveness of shaft base cleanout tools and techniques in wet holes can best be evaluated using a downhole camera, as described in Section 19.2.4.



Figure 5-34 Airlift and Hydraulic Pumps for Shaft Base Cleanout

#### 5.4.2 Grouting

On rare occasions, permeation or compaction grouting may be employed to stabilize a particularly unstable stratum or around a very large or deep hole. Baker et al (1982) report that grouting in advance of excavation can sometimes be used to reduce water inflow effectively and even to permit construction of underreams in granular soil. Examples were given where the technique was used successfully in Chicago.

The principles and use of grouting to enhance base resistance in granular soils was described in Chapter 4. Skin grouting through sleeve-port tubes along the side of the shaft has been used on rare occasions internationally, but is not commonly employed in U.S. practice.

Grouting through or within a drilled shaft is a technique which might be employed as a remediation for voids within the shaft or to treat a zone of low strength but permeable material trapped within the shaft concrete. Jet grouting has been employed around a drilled shaft where there were questions about the integrity of the cover over the reinforcing. These repair techniques are described in Chapter 21.

#### 5.4.3 Soil Mixing

Cement stabilization using soil mixing methods can be used to stabilize a column of soil around the location of a drilled shaft excavation. This technique may be used in wall construction whereby the soil mixed columns stabilize a zone between drilled shaft columns. If the soil conditions are favorable to the use of deep soil mixed columns, this technique may have advantages over secant shaft walls since the soil mix does not become so hard as to pose difficulty during excavation of the drilled shafts. Figure 5-35 illustrates an example where soil mixing was used to construct a drilled shaft wall to a depth 30 ft below grade for a transportation project in southern California. Drains and a wall facing were constructed after this photo was taken. Deep soil mixing methods are described in FHWA-RD-99-138 by Bruce (2000).

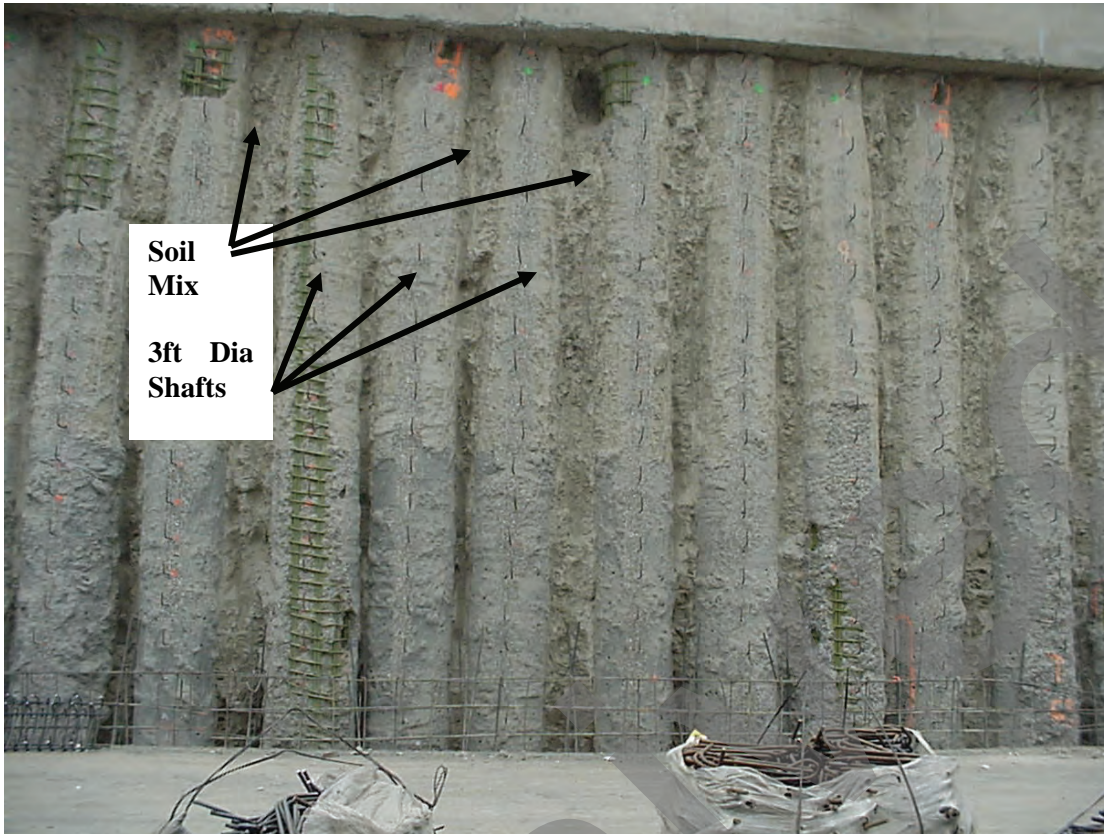


Figure 5-35 Use of Soil Mixed Columns in Conjunction with Drilled Shafts for a Wall

#### 5.4.4 Concrete Liner

Although not a very common practice, it is possible to construct a concrete lined shaft into an unstable formation using a special under-reaming tool. This technique was described by Gerwick (2004) as used on the Third Carquinez Bridge in California, where the drilled shafts for the south tower extended deeply into a steeply dipping claystone formation that was prone to caving. The drilled shafts were constructed by drilling a 9 ft diameter hole for a 16 to 22 ft long portion of the socket, reaming the hole to an 11 ft diameter using the “hole opener” tool, casting concrete, and redrilling a smaller 9 ft diameter hole through the concrete to the next section as illustrated in Figure 5-36. This process was repeated in stages to complete the 100 ft long socket. The reaming below the previously lined section was completed using a tool with roller bits that could be extended outward to enlarge the hole below the previous section.

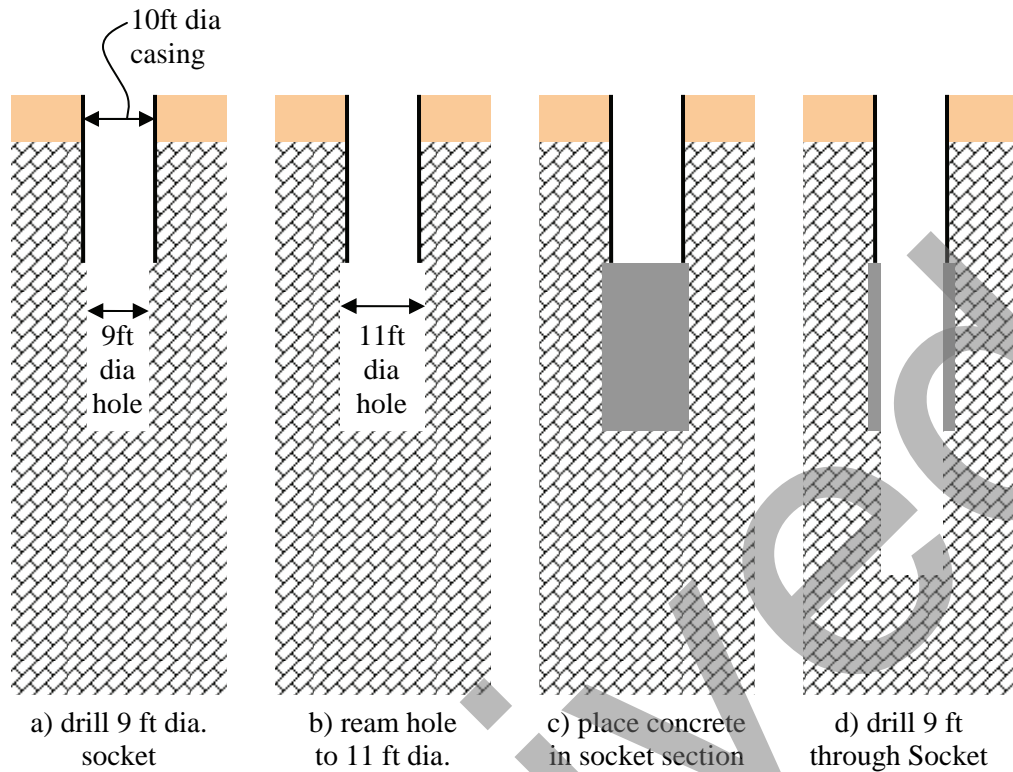


Figure 5-36 Construction of Concrete-Lined Shaft

## 5.5 SUMMARY

This chapter has described a variety of drilling machines and tools used for construction of drilled shafts. In recent years, the variety of machines and tools has increased as the industry matures and equipment becomes more specialized. The specific choice of tools and equipment is generally the responsibility of the contractor, and different constructors may approach the project differently depending upon their personal experience and resources. Engineers charged with design, specification, and inspection of drilled shafts must be knowledgeable of drilling equipment in order to provide appropriate specifications, and a constructable and cost efficient design. Sufficient subsurface information must be provided so that bidders can make an informed decision about equipment to use on the job. The tools and equipment that are planned for use by the contractor should be described in the contractor's drilled shaft installation plan and the equipment actually used documented in the construction records.

Temporary or permanent casings are additional tools that may be used to complete the drilled shaft, as described in detail in Chapter 6.

## **CHAPTER 6**

### **CASINGS AND LINERS**

Casings and liners play an important role in the construction of drilled shafts, and special attention must be given to their selection and use. Except for surface casing or guides, the casings and liners that are described in this chapter are used for support of the drilled shaft excavation, and/or may serve as a structural element of the completed drilled shaft. Casings and liners are used in conjunction with rotary drilling or other techniques described in Chapters 4 and 5 for constructing drilled shafts.

Casings are tubes that are relatively strong, usually made of steel, and joined, if necessary, by welding or, in some cases, bolting. Casings may also have special joints that allow torque and axial load to be transferred to the tip, such as those that are used with full depth casing machines.

Liners, on the other hand, are light in weight and become a permanent part of the foundation. Liners are often made of corrugated sheet metal pipe (CMP), but also may be made of plastic or pressed fibers (e.g., Sonotube™). While their use is much less frequent than that of casings, liners can become important in some situations.

#### **6.1 TEMPORARY CASING**

Temporary casing is used to stabilize the drilled shaft excavation and then removed after or during placement of fluid concrete. Contractors like to emphasize the fact that the casing that is used temporarily in the drilling operation is essentially a tool, so it is sometimes termed "temporary tool casing." This temporary casing is used to retain the sides of the borehole only long enough for the fluid concrete to be placed. The temporary casing remains in place until the concrete has been placed to a level sufficient to withstand ground and groundwater pressures. The casing is removed after the concrete is placed. Additional concrete is placed as the casing is being pulled to maintain the pressure balance. Thereafter, the fluid pressure of the concrete is relied upon to provide borehole stability. The use of temporary casing has been described briefly in Chapter 4.

When approved by the engineer, temporary casing used solely for support of the drilled shaft excavation may be left in place. In such cases, the engineer must assess the influence of the casing on the axial and lateral resistance of the completed drilled shaft.

Temporary casing must be cleaned thoroughly after each use to have low shearing resistance to the movement of fluid concrete. Casing with rough interior surface will increase the shearing resistance between the casing and the column of fluid concrete placed inside the casing. As the casing is lifted the drag on the column of concrete may cause the concrete to be lifted, creating a neck or a void in the concrete. The casing should be free of soil, lubricants and other deleterious material.

##### **6.1.1 Types and Dimensions**

Most drilling contractors will maintain a large supply of temporary casing of various diameters and lengths in their construction yards. A typical view of stored temporary casing is shown in Figure 6-1. Casing from the stockpile may be welded or cut to match the requirements of a particular project.



Figure 6-1 A Typical View of Stored Temporary Casing

Temporary casing must sometimes be seated into an impervious formation such as rock if the excavation is to be advanced below the casing in the dry. In such a circumstance, it will normally be necessary to use the casing as a tool, with twisting or driving forces applied through the casing. The end of the casing may be equipped with cutting teeth or additional thickness in order to facilitate installation.

ADSC: The International Association of Foundation Drilling, has adopted the outside diameter of casing as a standard and uses traditional units [e.g. 36-in. O.D.] because used pipe in O.D. sizes is available at much lower cost than specially rolled pipe with specified I.D. (ADSC, 1995). Specially ordered pipe of a specific size can be ordered, but at higher cost and with the added requirement of lead time for fabrication. Ordinarily, O.D. sizes are available in 6-inch increments 18 in., 24 in., 30 in., and so on up to 120 in. Larger sizes as shown in Figure 6-2 typically require special order and fabrication.

If temporary casing size is not specified, most contractors will usually employ a casing that has an O.D. that is 6 inches larger than the specified drilled shaft diameter below the casing to allow for the passage of a drilling tool of proper diameter during final excavation of the borehole. A drilling tool with a diameter equal to the specified shaft diameter below the casing will usually be used. If there is a boulder field or if the contractor otherwise decides to use telescoping casing, the first casing that is set may have an O.D. that is more than 6 inches larger than the specified shaft diameter.

The contractor is usually responsible for selecting a casing with sufficient strength to resist the pressures imposed by the soil or rock and internal and external fluids. Most steel casing has a wall thickness of at least 0.325 inches, and casings larger than 48 inch O.D. tend to have greater wall thicknesses. Installation with vibratory or impact hammers may require greater wall thickness than would be used for casing installed in an oversized hole. Most contractors rely on experience in the selection of casing wall thickness. However, if workers are required to enter an excavation, the temporary or permanent casing should be designed to have an appropriate factor of safety against collapse.





Figure 6-2 Exceptionally Large Temporary Casings

The computation of the allowable lateral pressure that can be sustained by a given casing is a complex problem, and methods for such computations are beyond the scope of this publication. The problem is generally one of assuring that buckling of the casing does not occur due to the external soil and water pressures. Factors to be considered are: diameter, wall thickness, out-of roundness, corrosion, minor defects, combined stresses, microseismic events, instability of soil on slopes and other sources of nonuniform lateral pressure, and lateral pressure that increases with depth.

Semi-rigid liners can be used for liners or temporary casing that may be left in place. They can consist of corrugated sheet metal, plain sheet metal, or pressed fiber. Plastic tubes or tubes of other material can also be used. These liners are most often used for surface casing where it is desirable to restrain unstable surface soil that could collapse into the fluid concrete, creating structural defects. For example, corrugated sheet metal is often used for this purpose when the concrete cutoff elevation is below working grade. Occasionally, rigid liners, such as sections of precast concrete pipe, are also used effectively for this purpose.

Rotators and/or oscillators with segmental casing (Figure 6-3) are increasingly being used to advance large diameter, deep drilled shafts. The casing penetration is advanced ahead of the excavation thus providing support for the excavation and eliminating the need for slurry for side wall stability. Slurry or water may still be necessary to prevent base heave. Soil can be removed within the casing with clam, hammer-grab, or rotary tools. The casing is typically high strength steel, often double-wall, with flush fitting joints between segments. Details of the connection between casing segments allow for the transmission of torque, compression, and tension between casing sections. This allows large torque (in either direction), compression, and lifting forces applied by equipment at the surface to be transmitted from the top section of casing to the bottom section of casing. Although the double walled casing shown in Figure 6-3 is most often used, it is possible to weld the casing joints to standard pipe as illustrated in Figure 6-4. In this case the casing joint will protrude into the interior of the casing.



Figure 6-3 Segmental Casing Installation with Oscillator System



Figure 6-4 Installation of Casing Joint on Standard Pipe

### 6.1.2 Installation and Extraction of Temporary Casing

As described in general in Chapter 4, temporary casing is often placed into an oversized drilled hole and then seated into the underlying formation to provide a stable environment, but temporary casing can also be advanced ahead of the excavation. Methods for installation and extraction of temporary casing are described below.

### 6.1.2.1 Casing Seated Through Drilled Hole

Temporary casing can be placed through a pre-drilled hole to seat the casing into an underlying formation of more stable material. The pre-formed hole may be constructed using the wet method with drilling slurry, or may sometimes be advanced without a drilling fluid if the soil will stand for a short period and the seepage into the hole is relatively small. The latter is often the case where the shaft can be drilled relatively quickly through a residual soil to rock, and the more time-consuming rock excavation is facilitated by having a temporary casing to prevent cave-ins of the overlying soil. If the shallow strata are water-bearing sands, it may be necessary to drill the starter hole with slurry to prevent caving. In some instances, contractors may use polymer slurry just to help “lubricate” the casing and make it easier to remove.

The excavation below the casing may be advanced as a dry hole if the casing is seated with a watertight seal into a relatively impermeable underlying formation of clay, chalk or rock. In order to seat the casing, a “twister bar” attachment to the kelly bar may be used to allow the drill rig to apply torque and crowd to the casing and advance it into the underlying soil or rock. Figure 6-5 illustrates casings with J-slots cut into the top to allow a casing twister to be used. In order to help the casing to cut into the underlying formation, the end of the casing is usually equipped with cutting teeth as shown in Figure 6-6. Various types of cutting teeth may be used, depending upon the type of material into which the casing is advanced; pointed rock teeth or even welded-on carbide chips may be used.



Figure 6-5 J Slots in Top of Casing for Use with Casing Twister

A good seal of casing into underlying rock can be very difficult if the rock surface is steeply sloping or highly irregular, or if the rock contains seams or joints that allow water inflow below the casing. An irregular hard surface will make the casing tend to deflect off alignment, break cutting teeth, and possibly bend the casing.

As described in Chapter 4, some contractors sometimes prefer to make deep excavations using more than one piece of casing with the “telescoping casing” process (Figure 6-7). This process has the economic advantage that smaller cranes and ancillary equipment can be used to install and remove telescoping casing than would be required with a single piece of casing. A borehole with a diameter considerably larger than that specified is made at the surface, and a section of casing is inserted. A second borehole is excavated below that section of casing, which is then supported with another section of casing of smaller diameter. This process may proceed through three or more progressively smaller casings, with the I.D.

(O.D- if excavating does not proceed below casing) of the lowest casing being equal to or greater than the specified diameter of the drilled shaft. The O.D. of a lower section of such "telescoping casing" is typically at least 6 inches smaller than the O.D. of the section above it, although larger differential diameters may be used when necessary. This procedure is most often used for drilled shafts that are bearing on or socketed into rock and where no skin friction is considered in the soils or rock that is cased. Care must be taken by the contractor that the process of removing the smaller section(s) of casing does not disturb the larger section(s) of casing still in place, or deposit water, slurry or debris behind casings still in place, thereby contaminating the fluid concrete. Telescoping casing may also be used to case through boulder fields where some boulders are removed and the casing is screwed ahead to refusal. The smaller inner casing is advanced through the first casing which retains the zone where the larger boulders were removed. The placement of concrete within a hole stabilized using telescoping casing is described in Chapter 9.



Figure 6-6 Teeth for Use in Sealing Casing into Rock (Photograph at top left courtesy of Herzog Foundation Drilling, Inc.)



Figure 6-7 Use of Telescoping Casing

### 6.1.2.2 Casing Advanced Ahead of Excavation

The contractor may choose to advance the casing ahead of the excavation in cases where the hole will not stand open for short periods or where slurry drilling techniques are considered less attractive from a cost or performance standpoint. There are two primary methods used to advance casing ahead of the excavation. The contractor may drive the casing in advance using a vibratory hammer, or using oscillator/rotator equipment.

#### 6.1.2.2.1 Vibro-Driven Casing

In the case of the driven casing, a vibratory hammer is almost always used for temporary casing; an impact hammer may be used to install permanent casing, but temporary casing will require a vibratory hammer for extraction since casing installed with an impact hammer may be impossible to remove. In principal, jetting could be utilized as an aid to installation, but jetting around the casing would not be advised during extraction due to the potential for jet water to adversely affect the fluid concrete.

In planning the construction of drilled shafts in congested areas, it should be noted that the use of vibratory installation of casing can cause significant vibrations that can affect nearby structures, or cause settlement in loose sands (which can affect nearby structures). The attenuation of vibrations with distance away from the source is affected by the size of the hammer and casing, the operating frequency of the hammer, the soil and rock properties, the localized stratigraphy, groundwater, and other factors that are likely site-specific. In most cases, vibrations from casing installation are extremely small at distances of 50 to 70 ft from the source. In cases where sensitive structures may be present nearby, a program of vibration monitoring should be included in the installation plan. Vibration monitoring can help avoid potential damage and can also provide documentation as protection against lawsuits or claims of damage caused by vibratory installation of casing. Monitoring during construction of the technique and test shaft installations can provide valuable measurements of vibrations at various radial distances from the source before moving the work into production locations. A useful reference on this subject is "Construction Vibrations" (Dowding, 2000).

Installation of the casing using a vibratory hammer is most effective in sandy soil deposits, and to penetrate through sandy soils into a clay or marl stratum below. The hammer clamps to the top of the casing (Figure 6-8), which is often reinforced at the end with an extra thickness to aid in resisting the transmitted forces. The vibration of the casing often causes temporary liquefaction of a thin zone of soil immediately adjacent to the casing wall so that penetration is achieved only with the weight of the casing plus the hammer. This technique is particularly effective in sandy soils with shallow groundwater. Penetration of an underlying hard layer such as hard rock may be difficult or impossible with a vibro-driven casing. Attempts to twist the casing with the drill rig to seat into rock are likely to be ineffective because of the side resistance of the soil against the casing after removal of the vibration.

In general, a vibratory hammer is used to place the entire length of temporary casing into the soil before excavation of soil inside the casing. However, to facilitate penetration through particularly dense soils, the casing can be installed by an alternating sequence of driving the casing and drilling to remove the soil plug within the casing. In this case, it would typically be necessary to install the casing in sections, with the sections joined by welding.

Removal of the casing with the vibratory hammer must be accomplished while the concrete is still fluid. During extraction, the hammer is attached and powered, and then typically used to drive the casing downward a few inches using the weight of the casing and hammer to break the casing free of the soil.

Once the casing is moved, the crane pulls the casing upward to remove it and leave the fluid concrete filled hole behind. The photo in Figure 6-8 shows the start of removal of a casing after completion of concrete placement.



Figure 6-8 Extraction of Temporary Casing Using a Vibratory Hammer

#### 6.1.2.2.2 Oscillator/Rotator Method

Installation of temporary casing ahead of the excavation may be accomplished with a drill using the special casing and tools illustrated previously in Figures 6-3 and 6-4. A general description of the machines used for the oscillator/rotator method of construction was provided in Chapter 5. The oscillator or rotator clamps onto the casing with powerful hydraulic jaws and uses hydraulic pistons to twist the casing and push it downward, reacting against a large drilling machine or temporary frame. The casing is therefore used in the same manner as a coring tool to advance into the soil or rock. In order to advance the casing and overcome the soil side shearing resistance to twisting, it is necessary that the casing have cutting teeth slightly larger than the outside dimension of the casing. The bottom section of casing is fitted with a cutting shoe to promote penetration (Figure 6-9) by cutting a slightly oversized hole and relieving the stress against the sides of the casing. The soil on the interior of the casing is excavated simultaneously as the casing is installed to remove the resistance of this portion of the soil.



Figure 6-9 Cutting Shoe for Segmental Casing

During installation of the casing, it is essential that a plug of soil remain inside the casing (typically about one shaft diameter in thickness) so that the bottom of the excavation does not become unstable during installation. In water-bearing soils, the head of water inside of the casing must also be maintained so that bottom heave does not occur. It is possible to use slurry inside the casing to maintain stability, but the need for slurry is usually avoided by maintaining a soil plug. It is necessary to maintain stability during installation because heave of soil into the casing would cause loosening of the ground around the excavation with adverse effects on side shear and possible subsidence around the shaft.

At completion of the excavation, the soil plug may be removed to the base of the casing (or below) if the casing is extended into a rock or stable formation or if a slurry head is used to maintain stability. If the hole terminates in water-bearing soil with only a water head for stability, it may be necessary that the casing extend below the base of the final excavation to avoid instability at the base. However, this procedure may result in an annular zone of loosened soil at the base of the drilled shaft excavation.

The thicker casing (typically about 2 to 2.5 inches) used with this method of construction is a consideration in selection of the cover and the spacers on the reinforcement cage. If a single wall pipe is used with the casing joints as shown in Figure 6-4, the joints will protrude inside the casing because the joint is typically thicker than the pipe. In such a case, the reinforcing cage will need to be fabricated and placed carefully so that nothing hangs on the casing joints during installation of the cage and/or extraction of the casing during concrete placement.

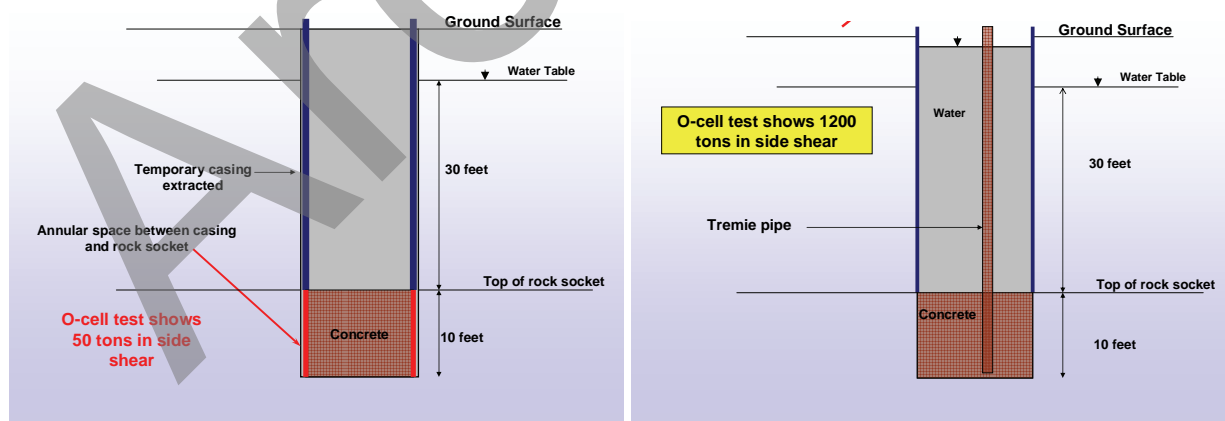
To avoid potential torsional deformation of reinforcement, the casing is typically oscillated back and forth during extraction, even if a continuous rotation was used during installation. The casing is typically extracted simultaneously as concrete is placed into the excavation, and concrete head above the tip of the casing must be maintained so that a positive concrete pressure is provided against the hole. If exterior groundwater pressure is present, the head of concrete and water inside the casing must exceed the exterior water pressure in order to prevent inflow of water and contamination of the concrete. It is also essential that the concrete remain fluid so that the oscillation of the casing does not transfer twisting forces into the reinforcing cage and cause distortion.

### 6.1.3 Possible Effects of Temporary Casing on Axial and Lateral Resistance

If temporary casing is to be used in construction, it is appropriate that the designer consider the possible effects of casing on axial and lateral resistance. In general, it is considered that there is no deleterious effect on the lateral resistance of a drilled shaft if the casing is removed, regardless of the method used for installation. The axial resistance can potentially be affected by the method of casing installation, which includes casing installed into a predrilled hole, or casing installed by vibratory or oscillator/rotator methods.

If the axial resistance of the drilled shaft is derived entirely from the soil or rock below the temporary casing, there is little concern regarding any adverse effects of the casing on load transfer in side resistance. Designers should consider the relative magnitude of the contribution to axial resistance derived from the temporary casing zone; if this contribution is relatively small compared to the drilled shaft below this level, then it is appropriate and cost-effective to ignore the axial resistance of this portion of the shaft so that the constructor can be permitted to use the most cost-effective strategy to install the drilled shaft. If the side resistance of the temporary cased zone is significant, then there are important considerations as outlined below.

Casing installed into a predrilled hole may affect side resistance within the cased portion of the shaft if contaminants or debris or loosened soil are trapped behind the casing and are left between the concrete and native soil or rock. Contaminants can become trapped if thick, heavy slurry is used and left in the annular space behind the casing. In addition, debris can fall into this annular space. Where temporary casing is installed into rock via a predrilled hole, it is likely that debris will collect in this space and a good concrete to rock bond will not be developed. An example of this problem is reported by Osterberg and Hayes (1999), and illustrated in Figure 6-10. A shaft was constructed using a casing extending the full length into a 10-ft deep rock socket in order to provide a dry excavation so that the base of the shaft in rock could be inspected. A bi-directional load test (described in Chapter 20) performed on the completed drilled shaft measured only 50 tons of side resistance in the rock socket, presumably because of trapped debris between the concrete and rock along the sidewall of the socket. At another drilled shaft constructed by terminating the casing above the rock and constructing the rock socket “in the wet” under water, the load test measured 1200 tons of side resistance in the rock socket. This extreme example illustrates the importance of a simple detail in constructing drilled shafts into rock with casing.



a) Dry hole with temporary casing through the rock section; b) wet hole with casing section at top of rock

Figure 6-10 Adverse Effect of Casing Extended into Rock Socket (Osterberg and Hayes, 1999)



Casing advanced ahead of the shaft excavation using a vibratory hammer should generally have no adverse effect in sands and can even have a beneficial effect by densifying the sand around the drilled shaft. However, a casing installed into and then extracted from a cohesive soil with a vibratory hammer is likely to result in a relatively smooth surface compared to a rough drilled hole. Camp et al (2002) noted the relatively lower side resistance of the upper portion of a marl formation when temporary casing was used compared to an uncased shaft drilled with slurry, a difference which was attributed to the smoother shaft surface.

Segmental casing advanced ahead of the drilled shaft excavation using the oscillator/rotator system is generally considered to have no significant effect on side shearing resistance so long as a stable excavation is maintained. The use of cutting teeth on the bottom of the casing and the oscillation of the casing during withdrawal tends to leave a rough surface texture on the drilled shaft, as illustrated in Figure 6-11. Comparative tests by Brown (2002) and others reported by Katzenbach et al (2008) suggest that this rough texture and other factors contribute to reasonably good unit side shear for drilled shafts constructed with this method compared to slurry methods, and possibly improved performance relative to shafts constructed using bentonite slurry. Since construction of very large or deep drilled shafts with bentonite slurry can be difficult to accomplish within the short time frame needed to avoid bentonite contamination at the interface, full length segmental casing can be a more favorable option for developing higher side resistance. However, failure to maintain stability at the base of the excavation can result in loosening of the soil around the shaft excavation and reduction of side resistance.

For cases, as noted in Section 6.1.2.2.2, where a temporary segmental casing extends below the final bottom of the drilled shaft, an annular zone of loosened soil may form below the base of the drilled shaft. This disturbed annular zone may result in slightly reduced base resistance unless corrected by base grouting beneath the completed drilled shaft.



Figure 6-11 Exposed Surface of Drilled Shafts Constructed Using Oscillated and Rotated Casing

If temporary casing is installed and then the constructor is unable to extract the casing, the responsible engineer needs to apply judgment to the evaluation of the effect of the casing on the axial resistance of the drilled shaft. Expedient load-testing methods, such as those described in Chapter 20, may be helpful in evaluating side resistance around casings that are left permanently in place. Although it is impossible to make general statements that apply to all cases, some studies have been conducted that show that the load transfer from the casing to the supporting soil can be significantly less than if concrete had been in contact with the soil (Lo and Li, 2003; Owens and Reese, 1982). Owens and Reese (1982) describe three drilled shafts in sand, one of which was constructed in the normal manner by the casing method and two of which were constructed in an oversized holes with casings left in place. The two drilled shafts that were constructed with the permanent casings had virtually no load transfer in skin friction in the region of the oversized excavation, as might have been expected. The annular space between the casing and the parent soil was subsequently filled with grout. A small-diameter pipe was used to convey the grout into the space. The grouting led to a significant increase in load capacity. The skin friction for the grouted piles was on the order of that for the normally-constructed shaft, but the volume of grout that was used was much larger than the volume of the annular space around the casings. While grouting is plainly an effective method of increasing the load capacity of drilled shafts for those cases where casings are left in place by mistake, it is not possible to make recommendations about detailed grouting techniques and about the amount of the increase in load transfer when grouting is employed.

Owens and Reese (1982) reported another study in which a casing was inserted into sand by use of a vibratory driver. After the concrete was placed, it was impossible to pull the casing with the vibratory driver, even as supplemented by other lifting machines that were on the job. A second drilled shaft was constructed by use of the same procedure, but in the second case the contractor used care before the concrete was placed to make sure that the casing could be lifted. Both of the drilled shafts were load-tested, and the one with the permanent casing was able to carry much less load than the one constructed in the usual manner. For this particular case, the load transfer in skin friction was significantly less for the steel pipe that was placed by a vibratory driver than for the concrete that was cast against the sand.

Temporary casing which cannot be removed and is left in place in an oversized hole may reduce the lateral stiffness of the shaft due to the void. In this case, it is recommended that the void be grouted to ensure transfer of lateral soil resistance around the shaft even if there is no reliance on the cased zone for axial resistance.

#### **6.1.4 Removing Casing after Concrete Sets**

Drilled shafts installed through a body of water typically use a permanent casing that serves as a form until the concrete sets, and then is left permanently in place. It is often specified to remove portions of otherwise permanent casing that is exposed above the ground surface or above the surface of a body of water following completion of the drilled shaft installation and after the concrete has reached sufficient strength. In such cases, typically only a short section of casing would need to be removed. The removal would typically be accomplished by torch cutting the steel into sections, taking care to avoid damaging the underlying concrete surface, and detaching the individual sections from the surface of the concrete. However, temporary casings have occasionally been used for such applications, including various types of removable forms attached to the top of the permanent casing. There have been numerous reports of difficulties with the use of temporary casing over water.

An example of a removable casing is shown in Figure 6-12; this photo is taken from the I-95 Fuller Warren Bridge over the St. Johns River in Jacksonville, Florida. For this project, the removable casing was fabricated with a split seam that extended the entire length of the casing and was joined by a mechanical pin arrangement that kept the joint closed during casing installation and concrete placement,

and expanded the joint to facilitate removal of the casing after the concrete achieved the required strength. A rubber gasket was placed in the joint in an effort to make the joint water tight. In this example, the 72-inch diameter casings were advanced with a vibratory hammer through soft river bottom deposits either to a stiff silty clay layer or to limestone. After the drilled shaft concrete set, the pin mechanism was lifted to expand the joint, making the inside diameter of the casing slightly larger than the diameter of the drilled shaft, and allowing the casing to be lifted off the drilled shaft. The contractor selected this method to allow re-use of the casings for a number of offshore foundations, and thereby reduce the cost of steel casing. However, the use of removable casing for this project presented several problems that are often encountered with this type of solution:

- a. After the initial use of the casing, the joint was typically not water tight despite cleaning and repair of the joint,
- b. The contractor had difficulty opening the split joint, possibly due to fouling of the mechanism with concrete,
- c. Once the joint was opened, the contractor had difficulty lifting the casing off the drilled shaft even with the use of a vibratory hammer,
- d. When the casing was removed, diver inspection identified surface defects on the drilled shaft, including washout of cement along portions of the drilled shaft that had been adjacent to the split joint, numerous spalls and bleed water cavities around the remainder of the drilled shaft, and locally exposed steel reinforcement, and
- e. To correct the observed defects, costly underwater remediation measures had to be implemented.

As this project case history illustrates, the use of removable casing may pose risk of structural defects to the drilled shafts. In addition, inspection of the completed drilled shafts and repair of any identified defects is complicated since this work must be accomplished under water, sometimes working under difficult conditions of limited visibility and swift currents. Accordingly, the use of removable casing at offshore foundations should generally be avoided.



Figure 6-12 Locking Mechanism for a Removable Casing

An alternative approach that may entail less risk of defects in the shaft is illustrated in Figure 6-13. This approach uses a temporary casing which is sufficiently large to function as a cofferdam. The drilled shaft constructed through the temporary casing may include a permanent casing or may simply be constructed using a drilling fluid in an uncased hole. The concrete placement can be terminated below the water surface and a removable form placed inside to form the column and splice the column reinforcement to the drilled shaft reinforcement. With this solution, the removable form is not subject to the handling stresses of a temporary casing and the concrete within the form can be placed in the dry after removal of laitance at the cold joint. After removal of the column form, the temporary casing extending above the top of shaft cutoff can be removed by divers with torches.

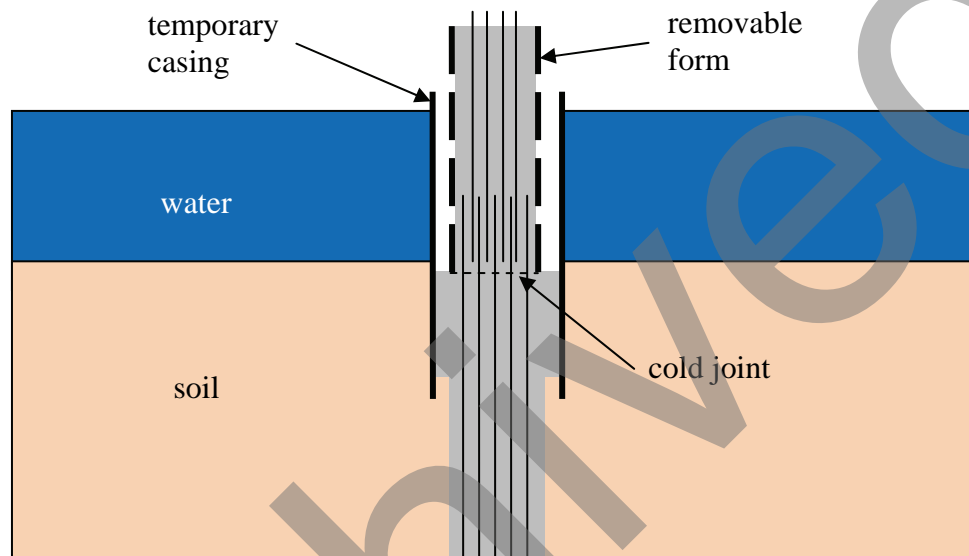


Figure 6-13 Construction Joint Below the Water Surface

## 6.2 PERMANENT CASING

As implied by its name, permanent casing remains and becomes a permanent part of the foundation. An example of the use of permanent casing is when a drilled shaft is to be installed through water and the protruding portion of the casing is used as a form. A possible technique that has been used successfully is to set a template for positioning the drilled shaft, to set a permanent casing through the template with its top above the water and with its base set an appropriate distance below the mudline, to make the excavation with the use of drilling slurry, and to place the concrete through a tremie to the top of the casing. One possible objection to the use of such a technique is that the steel may corrode at the water level and become unsightly.

Several examples of the use of permanent casing are given in Figure 6-14. The thickness and type of material used for the permanent casing is primarily a function of the stresses to which the casing is subjected prior to placement of concrete.

One consideration for using permanent casing is the time that will be required to place the concrete for a deep, large-diameter, high-capacity drilled shaft founded in sound rock. Control of the concrete supply may be such that several hours could pass between placing the first concrete and extracting temporary

casing. In that case, the concrete may already be taking its initial set when the seal is broken by raising the casing, making it difficult to extract the temporary casing without damaging the concrete in the drilled shaft. In such as case, permanent casing may be specified.

Another common situation for using permanent casing is when the drilled shaft must pass through a cavity, as in a karst formation. The permanent casing becomes a form that prevents the concrete from flowing into the cavity. In addition to the cost of the additional concrete lost due to exterior voids in the rock, the flow of concrete into large cavities can result in mixing of soil or water into the drilled shaft, producing a void in the structure.

Permanent casing is also commonly used for drilled shafts that extend through very soft soils, such as marsh deposits, to reach an underlying stratum which is more stable. In such cases, the permanent casing is used to prevent the outward bulging of the fluid concrete into the surrounding soft soils. If a bulge forms at an elevation corresponding to an extremely soft stratum, there can be a risk of defects in the concrete due to a neck in the shaft above the bulge, or deformation of the reinforcement cage.

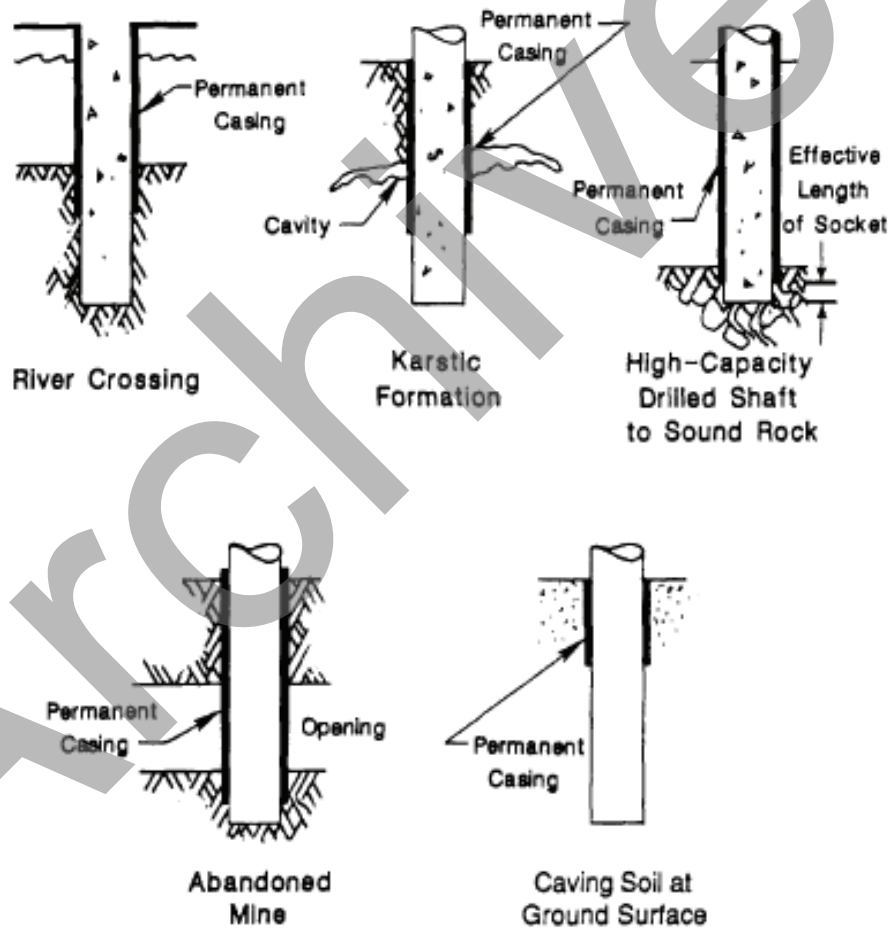


Figure 6-14 Examples of Use of Permanent Casing

## 6.2.1 Types and Dimensions

Types and dimensions of permanent steel casing may be similar to those described previously for temporary casing. The major difference is that the permanent steel casing need not be extracted and so longer sections of pipe may be driven into place similar to the installation of a steel pipe pile. If the permanent casing is to be used as a structural component within the drilled shaft, the casing dimensions, material properties, and welds are typically shown in the contract documents and are subject to quality control and documentation as would be required for a steel pipe pile or any steel structure.

The left photo in Figure 6-15 shows permanent casings extending into a cofferdam after placement of the seal concrete and dewatering of the cofferdam. These permanent casings were used to extend the shafts through the river water to an underlying rock bearing layer. The casings were also designed to utilize the bond between the casing and the seal concrete in order to engage the axial resistance of the drilled shaft against the upward water pressure on the base of the seal; in this way, the thickness of the seal was reduced compared to the thickness of seal that would be required based on the dead weight of concrete alone. The right photo in Figure 6-15 shows the drilled shaft reinforcement after the exposed casings were removed.



Figure 6-15 Permanent Casing Used for a Shaft Group Foundation in a River

Some additional types of materials might be used for permanent liners, such as the corrugated metal pipe (CMP) illustrated in Figure 6-16. This material is sometimes used for a liner at shallow depth because of the relatively low cost. However, CMP is relatively flexible and cannot be subject to installation stresses as conventional thicker walled steel pipe.

A semi-rigid liner may also be used to minimize the skin friction that results from downdrag or from expansive soils. Coatings that have a low skin friction (such as bitumen) have also been used. Liners made of two concentric pressed-fiber tubes separated by a thin coating of asphalt have been found to be effective in reducing skin friction in drilled shafts constructed in expansive soils by as much as 90 per cent compared to using no liner.

Flexible liners are used infrequently in the United States, but can have an important role in certain situations. Flexible liners can consist of plastic sheets, rubber-coated membranes, or a mesh. The rebar cage can be encased in the flexible liner before being placed in a dry or dewatered hole; then, the concrete is placed with a tremie inside the liner. The procedure is designed to prevent the loss of concrete into a

cavity in the side of the excavation or perhaps to prevent caving soil from falling around the rebar cage during the placement of the concrete. Flexible liners are applicable only to those cases where the drilled shaft is designed to develop the required resistance entirely below the level of the liner, because skin friction in the region of the liner cannot be computed with any accuracy.



Figure 6-16 Corrugated Metal Pipe (CMP) Used as Permanent Liner

### 6.2.2 Installation of Permanent Casing

Permanent steel casing may be installed using any of the methods described previously for temporary casing, or the permanent casing may be driven into place using an impact hammer. Permanent casing installed into an oversized hole may be advanced into an underlying rock formation by twisting or driving. In this case it is often necessary to fill the annular space with tremie grout in order to provide transfer of lateral soil resistance. Filling of the annular space may be unnecessary if the overburden soil is neglected for lateral loading or subject to scour.

Installation of the casing by driving can be an effective and efficient means of installing a permanent casing, since it will not need to be extracted. Installation of a large steel pipe using an impact hammer subjects the pipe to driving stresses and requires consideration of drivability as described in the FHWA Driven Pile Manual (Hannigan et al, 2006). There are obvious limitations to the ability to drive large diameter steel pipe into hard soils or rock, and boulders can be particularly troublesome. Where rock or boulders are anticipated, impact driving of permanent steel casing into these materials can result in deformation of the end of the casing so that drill tools cannot pass; in such cases a more attractive alternative may include the placement of permanent casing into a drilled hole or the use of a reduced length casing with slurry construction below the casing.

### 6.2.3 Effects of Permanent Casing on Axial and Lateral Resistance

If the soil within the cased zone is scourable or not capable of providing a significant contribution to the design, then the resistance of the soil around the permanent casing should not be considered a part of the design, and the method of installing the casing is unimportant from this perspective. If the soil within the cased zone is considered to provide a significant contribution to axial resistance, then the casing must be installed in such a way as to provide good load transfer through side resistance. Casing installed into an oversized hole generally cannot be relied upon to provide axial load transfer.

Even if there is no reliance placed on the cased zone for axial resistance, there may be other considerations related to the use of an oversized hole around the outside of a permanent casing. If lateral resistance is required within the zone of a permanent casing installed into an oversized hole, then the annular space around the outside of the casing should be filled with grout. An unfilled oversized hole can also provide an unintended seepage conduit, which could present a problem when working near flood control levees or other water retention structures, or when there is a risk of cross contamination of aquifers in areas where contaminated soils are present. Expansive soil or rock strata at depth could also be exposed to increased water content if an oversized hole allows downward migration of water alongside the permanent casing.

Casing which is driven using an impact hammer and left in place should provide similar axial side resistance to that of a driven steel pipe pile and may be considered as such. Caltrans often refers to this type of permanent cased hole as a “Cast-in-Steel-Shell” (CISS) pile. Where permanent casing is vibrated into place, the axial resistance of the casing in side shear may be less than that of an impact driven casing.

A permanent casing can contribute to the structural capacity and bending stiffness of the drilled shaft as discussed in Chapter 16. However, since corrosion will decrease the thickness of the steel casing with time, this should be considered in determining the contribution of the casing to structural capacity. Aggressive conditions are a particular concern for casings in contact with fill soils, low pH soils, and marine environments. Aggressive conditions are identified by determining specific properties of the fill, natural soil, and groundwater. Aggressive conditions are identified if the soil has a pH less than 4.5. Alternatively, aggressive conditions exist if the soil resistivity is less than 2000-ohm-cm. Chloride ion content and/or sulfate ion content should be conducted for soil resistivity values between 2000-5000 ohm-cm. Aggressive soil conditions exist if the sulfate ion content exceeds 200 parts-per-million (ppm) or the chloride content exceeds 100 ppm. Soils with resistivity greater than 5000 ohm-cm are considered non-aggressive. Hannigan et al (2006) report a conservative estimate for a corrosion rate of 0.003 inch/year for steel piles buried in fill or disturbed natural soil. An in-depth review of corrosion is beyond the scope of this manual, and the reader is referred to the work of Hannigan et al. (2006); AASHTO Standard R 27-01 (2004); and Elias, et al. (2001).

### **6.3 SUMMARY**

Casing provides a variety of functions in the construction of drilled shafts, ranging from short surface casing for protecting the top of the shaft excavation, to temporary casing for supporting the hole within unstable or water bearing soil layers, to permanent applications where the casing may serve as a concrete form through water or as a structural component of the completed drilled shaft, to note just a few. Whether temporary or permanent, however, the method used for installation of the casing, and for removal of temporary casing, can have a significant influence on the performance of the drilled shaft.

This chapter provided an overview of the various applications for casings and liners, identified the common methods and equipment used for casing installation and extraction, and discussed potential effects of casings on the axial and lateral resistance of the completed shaft. The information in this chapter, as well as the following chapter on drilling fluids, provides a general understanding of the construction techniques available to facilitate installation of drilled shafts in difficult ground and groundwater conditions.



## CHAPTER 7

### DRILLING FLUIDS IN DRILLED SHAFT CONSTRUCTION

#### 7.1 INTRODUCTION AND BACKGROUND

Drilling fluid is employed in the wet method of construction, as described in Chapter 4, and may also be used with the casing method of construction. Drilling fluid therefore plays an important role in drilled shaft construction and its proper use must be understood by both contractors and engineers. When a drilled shaft is to be installed through potentially caving soils or below groundwater, filling of the excavation with properly-mixed drilling fluid allows the excavation to be made without caving. As described in Chapter 4, once the excavation has been completed through the potentially caving layer, construction typically proceeds in one of two ways. In one procedure, a casing is installed and sealed into impermeable soil or rock. The fluid is then bailed or pumped from inside the casing. The shaft can be excavated in the dry to greater depth, followed by placement of the concrete. The second procedure is to maintain fluid in the excavation until the final depth is achieved. Concrete is then placed by tremie starting at the bottom of the borehole, so that the rising column of fluid concrete completely displaces the drilling fluid (slurry-displacement method). In either of these procedures the drilling fluid must have the proper characteristics during the drilling operations and, for the slurry-displacement method, at the time of concrete placement. The required characteristics of the drilling fluid and proper procedures for handling the fluid are the topics of this chapter.

Water alone is sometimes used as a drilling fluid and may be quite effective where the formations being penetrated are permeable but will not slough or erode when exposed to water in the borehole. Examples of formations suitable for using water include permeable sandstone and cemented sands. The level of water in the excavation should be kept above the piezometric surface in the natural formation so that any seepage is from the excavation into the formation, and not from the formation into the excavation. Inward seepage (into the excavation) is likely to cause sloughing of the sides of the borehole.

During the 1950's and 1960's it was common practice for drilled shaft contractors to create a slurry by mixing water with on-site clayey soils, primarily for use with the casing method. The resulting fluid has properties that are difficult to control and suffers from the fact that it is unstable -- that soil particles are continuously falling out of suspension -- which makes cleaning of the borehole difficult and which can lead to soil settling from the slurry column into the fluid concrete during concrete placement if the wet method of construction is used. For this reason the use of drilling fluids made from on-site materials, referred to as uncontrolled slurry, is not normally recommended for drilled shaft construction.

Drilling fluids are made from several different types of materials which when mixed with water can be controlled in a manner that makes them highly effective for the support of boreholes. Suitable materials include several naturally occurring clay minerals, and polymers. Bentonite is the common name for a type of processed powdered clay consisting predominately of the mineral montmorillonite, a member of the smectite group. Technologies pertaining to the use of mineral slurries as drilling fluids have been developed extensively by the petroleum industry, and many references on bentonite slurries are available; for example, Chilingarian and Vorabutr (1981) and Gray et al. (1980). While these references are useful, this information must be balanced by knowledge gained through field experience pertaining specifically to drilled shaft construction. Other processed, powdered clay minerals, notably attapulgite and sepiolite, are occasionally used in place of bentonite, typically in saline groundwater conditions. Any drilling fluid that is made from one of these clay minerals is referred to as mineral slurry.

A second group of materials used to make drilling slurry is polymers [from Greek *polymeres*, having many parts: poly + merous]. The term polymer refers to any of numerous natural and synthetic compounds, usually of high molecular weight, consisting of individual units (monomers) linked in a chain-like structure. Synthetic polymer slurries made from acrylamide and acrylic acid, specifically termed anionic polyacrylamide or PAM, entered the drilled shaft market beginning in the 1980's. More recently, advanced polymers made by combining polyacrylamides with other chemicals have been introduced in an effort to improve performance while minimizing the need for additives.

A growing trend of increasingly strict regulations governing the disposal of drilling fluids has become an important issue for drilled shaft contractors. Mineral slurries must be handled carefully, not allowed to flow into surface water or sewers, and disposed of in an approved facility at the end of a project. These requirements generally force the contractor to handle mineral slurries in a closed loop process -- that is, to condition slurry continuously and re-use it from borehole to borehole in order to eliminate the need to spoil the slurry on the site and to minimize the amount of slurry that has to be disposed of at the end of the project. Such careful handling obviously adds to the cost of excavating with mineral slurry. Handling and disposal of polymer slurries may also be subject to environmental regulations. Some jurisdictions require waste polymer slurry to be transported to a waste water treatment plant after obtaining the plant's approval. Concerns have also been raised over the potential effects of polymer-based slurries on drinking water aquifers.

While drilling fluids have proved effective in advancing boreholes through many types of unstable soil and rock, the use of drilling fluid of any type should be avoided for economic reasons unless it is necessary for the completion of a borehole. The additional cost on a job can be considerable for drilling fluid materials, handling, mixing, placing, recovering, cleaning, testing, and disposal.

## **7.2 PRINCIPLES OF DRILLING FLUID PERFORMANCE FOR DRILLED SHAFTS**

With proper use and handling, both mineral and polymer slurries are effective in meeting the principal objectives of (1) maintaining a stable excavation, and (2) allowing clean displacement by fluid concrete. However, the mechanisms controlling the performance characteristics of each type of slurry are different.

### **7.2.1 Mineral Slurries**

Bentonite and other clay minerals, when mixed with water in a proper manner, form suspensions of microscopic, plate-like solids within the water. When introduced into a drilled shaft excavation, this solid-water suspension, or slurry, contributes to borehole stability through two mechanisms:

1. formation of a filter cake (or "mudcake"), which effectively acts as a membrane on the sidewalls of the borehole
2. a positive fluid pressure acting against the filter cake membrane and borehole sidewalls

The concept is illustrated in Figure 7-1. For the filter cake to be established, fluid pressures within the slurry column in the borehole must exceed the groundwater pressures in the permeable formation (*i.e.*, positive fluid pressure), causing the slurry to penetrate the formation and depositing suspended clay particles on the surface of the borehole. The action of clay particle transport and deposition is termed "filtration" and once the filter cake is formed filtration gradually stops. At this point, a positive fluid pressure must be maintained to provide continued stability. As shown in the figure, it is necessary to maintain a slurry head inside the borehole so that the fluid pressure on the inside surface of the filter cake exceeds the fluid pressure in the pores of the soil in the formation. This differential pressure and the

resulting seepage into the formation cause a positive effective stress against the walls of the borehole, which acts to hold the membrane in place. It is the combination of membrane formation and positive fluid pressure against the borehole wall that enables a mineral slurry to stabilize a drilled shaft excavation. Unless the contractor continuously maintains a positive head difference, however, the borehole could collapse, because backflushing of the filter cake can occur if the head in the slurry column becomes less than the head in the formation, even for a short period of time.

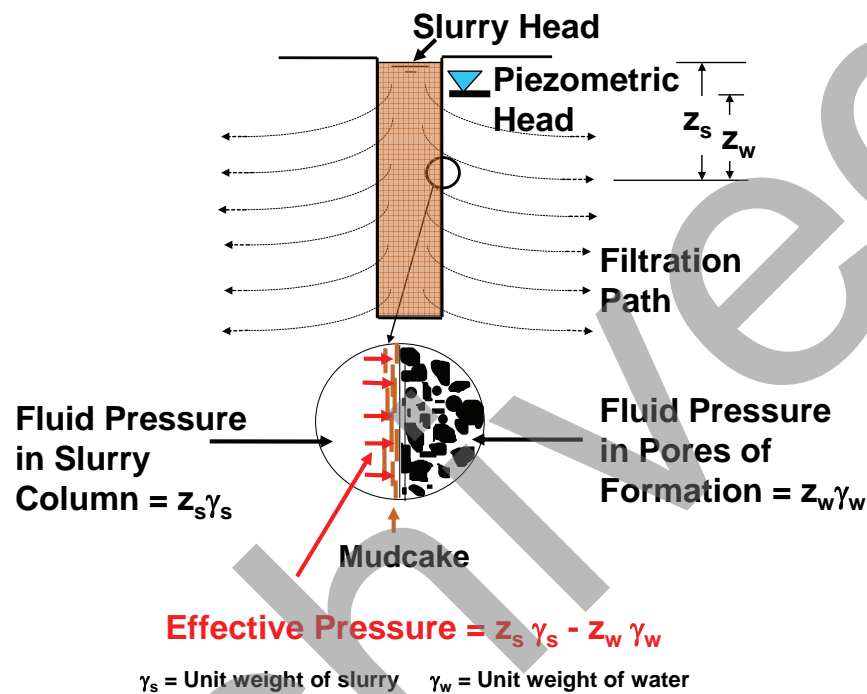


Figure 7-1 Formation of Filter Cake and Positive Effective Pressure, Mineral Slurry in Sand Formation

Several important factors can impact the ability of bentonite slurry to function as intended. The most important of these are: (1) proper hydration, (2) pore size distribution of the permeable formation, and (3) suspension of solids derived from the excavated materials. Each of these is discussed below.

In order for bentonite slurry to form a proper filter cake and suspend cuttings, the individual clay particles must be fully hydrated. Hydration refers to the formation of an electrochemically bound layer of water surrounding each particle. Once formed, the colloidal suspension promotes repulsion of the bentonite particles, referred to as dispersion, and keeps the bentonite in suspension almost indefinitely. A properly hydrated and dispersed slurry exhibits a smooth, lump-free consistency. Proper hydration requires both mixing effort (shearing) and time. One of the cardinal rules of drilling with bentonite slurry is that all newly mixed bentonite must be allowed to hydrate fully before final mixing and introduction into a borehole. Standard industry practice is to hydrate bentonite slurry for 24 hours prior to its use in drilled shaft construction. Bentonite slurry should be added to the borehole only after its viscosity stabilizes, which is an indication that the bentonite has become fully hydrated.

When the pore sizes in the formation being excavated are large (as in gravelly soils or poorly graded coarse sands) the filter cake may be replaced by a deep zone of clay platelet deposition within the pores that may or may not be effective in producing a stable borehole. This effect is illustrated in Figure 7-2. Nash (1974) notes that a bentonite slurry penetrating into a gravel quickly seals the gravel if there are no enormous voids. He notes that the main factors involved in the ability of the slurry to seal the voids in gravel are: (1) the differential hydrostatic pressures between the slurry and the groundwater, (2) the grain-size distribution of the gravel, and (3) the shearing strength of the slurry. It is obvious that slurry will penetrate a greater distance into an "open" gravel than into one with smaller voids. As the velocity of flow of the slurry into the soil voids is reduced due to drag from the surfaces of the soil particles, a thixotropic gelling of the slurry will take place in the void spaces, which may afford some measure of stability. If the bentonitic slurry proves ineffective, special techniques (for example, use of casings, other types of drilling slurry, or grouting of the formation) may have to be used to stabilize the borehole.

After mixing, mineral slurries have unit weights that are slightly higher than the unit weight of the mixing water. Their specific gravities, with proper dosages of solids, are typically about 1.03 - 1.05 after initial mixing. During excavation, particles of the soil or rock being excavated will be mixed into the slurry and become suspended. Below a certain concentration the soil particles will stay in suspension long enough for the slurry to be pumped out of the borehole and/or for the slurry (with suspended cuttings) to be completely displaced by an upward flowing column of high-slump fluid concrete. However, as drilling progresses and the slurry picks up more soil, its unit weight and viscosity will increase. This is not detrimental up to a point; however, excessive unit weight and viscosity will eventually have to be corrected by the contractor if mineral slurry is re-used or prior to concrete placement. During construction, measurements of slurry unit weight, viscosity, and sand content are used to determine whether corrections are needed. These tests are covered later in this chapter.

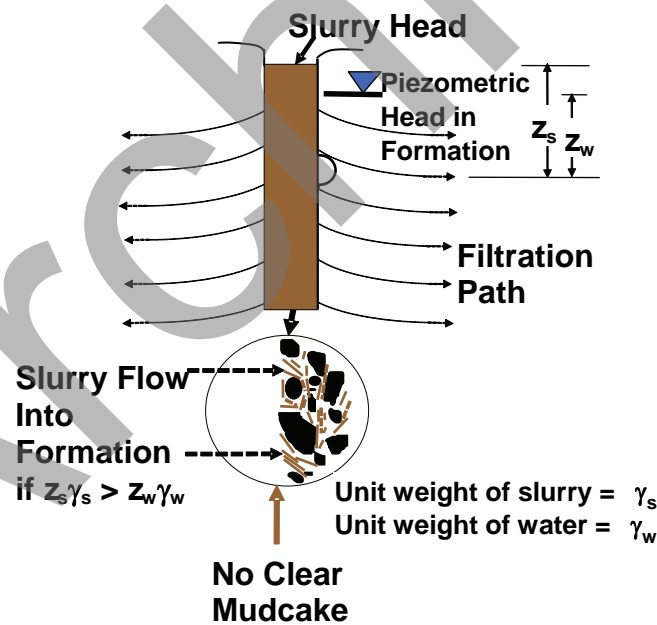


Figure 7-2 Mineral Slurry Plates in Pores of Open-Pored Formation (Modified after Fleming and Sliwinski, 1977)

Bentonite slurry is not suitable for all ground conditions. Bentonite use should be restricted when constructing a drilled shaft in smooth-drilling rock (*e.g.*, generally uniform sandstone) in which bond

between the concrete and the rock is achieved by penetration of cement paste into the pores of the rock (Pells et al., 1978). Bentonite will usually inhibit such a bond from forming and will produce values of side resistance that will be lower than would be predicted by the design methods suggested in this manual. Another situation where bentonite may be problematic is where groundwater is high in salt content, which may cause flocculation and failure of the particles to remain in suspension. Bentonite can sometimes be used for limited periods of time in saline water by first mixing it with fresh water and then mixing the resulting fluid with additives such as potassium acetate to impede the migration of salt into the hydrated zone around the clay plates, sometimes referred to as the "diffuse double layer". With time, however, the salts in salt water will slowly attack the bentonite and cause it to begin to flocculate and settle out of suspension. Therefore, in this application, careful observation of the slurry for signs of flocculation (attraction of many bentonite particles into clumps) should be made continuously, and the contractor should be prepared to exchange the used slurry for conditioned slurry as necessary.

Minerals other than bentonite are used in limited amounts under certain circumstances. The most common are the minerals attapulgite and sepiolite. Typically, these are used for drilling in permeable soils in saline environments at sites near the sources of the minerals (*e.g.*, Georgia, Florida, and Nevada), where transportation costs are relatively low. Unlike bentonite, attapulgite and sepiolite are not hydrated by water and therefore do not tend to flocculate in saline environments. These minerals do not tend to stay in suspension as long as bentonite and require very vigorous mixing and continual remixing to place and keep the clay in suspension. However, since hydration is not a factor, the slurries can be added to the borehole as soon as mixing is complete. They do not form solid mudcakes, as does bentonite, but they do tend to form relatively soft, thick zones of clay on the borehole wall, which are generally effective at controlling filtration and which appear to be relatively easy to scour off the sides of the borehole with the rising column of concrete. It should always be verified by testing or experience that the mineral selected for slurry is compatible with the groundwater chemistry, especially at sites with low pH or contamination.

Properly prepared mineral slurry, in addition to keeping the borehole stable, also acts as a lubricant and reduces the soil resistance when a casing is installed. The wear of drilling tools is reduced when slurry is employed.

### **7.2.2 Polymer Slurries**

Suitable mixtures of polymers and water represent the other major category of drilling fluids used for drilled shaft construction. Polymer slurries have become popular for use in all types of soil profiles because, compared to bentonite slurries, they require less processing before re-use and the costs of disposal can be less. However, as noted previously, there appears to be growing concern over the potential environmental effects of polymers and increasingly more strict requirements pertaining to its use and disposal.

The term "polymers" covers a very broad spectrum of materials and technologies. Synthetic polymers, derived from petroleum, exhibit a wide range of chemistries and characteristics. The polymers used in drilling slurries consist of long, chain-like hydrocarbon molecules which behave, in some respects, like clay mineral particles in their interactions with each other and in the way in which they stabilize a borehole. Figure 7-3a is a scanning electron micro-photograph of a polymer slurry magnified to 800 times its actual size. The polymeric strands form a three-dimensional lattice or web-like structure. This organizational structure, in combination with various other physical and performance characteristics of the polymer slurry, allow it to form a polymeric membrane on the excavation sidewall. The membrane allows for fluid loss control and for positive pressure to be exerted against the excavation sidewall, provided the head in the slurry column exceeds the piezometric head in the formation being drilled.

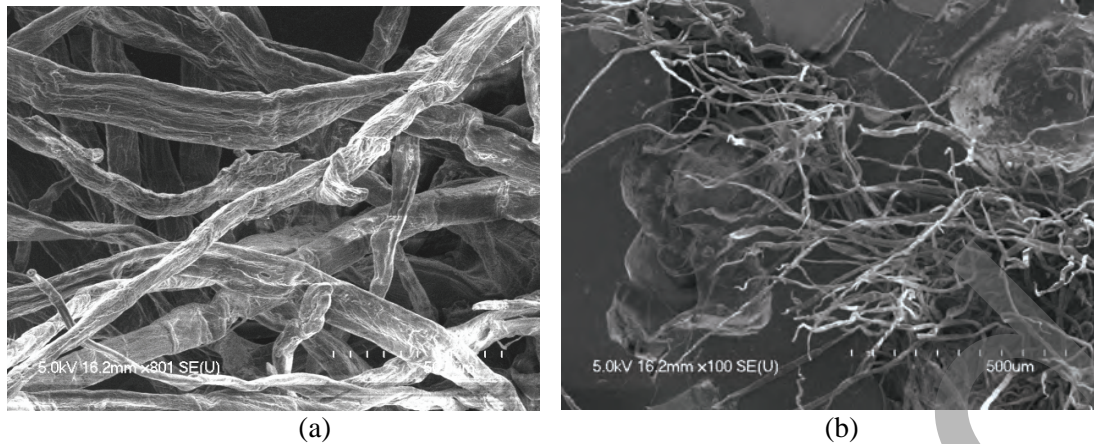


Figure 7-3 PAM Polymer Slurry ; (a) Polymer Slurry, 800x; (b) Slurry Interacting with Ottawa Sand, 100x (Photos courtesy of Likos, Loehr, and Akunuri, University of Missouri – Columbia)

When polymer slurry is introduced, there is an initial fluid loss into the formation. This penetration of polymer slurry into a porous formation allows the polymer to interact with the soil particles by chemical adhesion, creating a bonding effect and improving stability. The strength of adhesion varies significantly between polymer types and can be affected by various additives. Depending on the specific polymer and additives, the overall effect can range from a small strength increase to something approaching a true chemical grout effect.

The polymer chains within PAM's (polyacrylamide) are intended to remain separate from one another in the slurry through electrical repulsion, and therefore remain in suspension in the makeup water. Particle repulsion is achieved by imparting a negative electrical charge around the edges of the backbones of the polymer chains. Clean polymer slurries continuously penetrate into permeable formations (sand, silt, and permeable rock) at a linear rate of fluid loss determined by the viscosity of the slurry. As long as the head of the polymer slurry in the column exceeds the piezometric head in the formation being drilled, the excavation is typically stable. Since the polymer molecules are hair-shaped strands and not plate-shaped, they do not form a filter cake unless the slurry has ample entrained colloidal fines. Rather, borehole stability is produced through continual filtration of the slurry through the zone containing the polymer strands, in combination with the adhesion and three-dimensional structure described above (Figure 7-4). The drag forces and cohesion formed through the binding of the soil particles with the polymer strands and colloidal fines tend to keep the soil particles in place. Eventually, if enough fluid with entrained colloidal fines is deposited, filtration may cease due to the viscous drag effects coupled with the construction of a colloidal filter cake in the soil near the borehole and on the excavation surface. Colloids are drilled fines which have become suspended within the slurry.

Polymer slurries designed to perform as described above, through filtration, are continuously being lost to the formation. The contractor must be diligent in maintaining a positive head in the slurry column with respect to the piezometric surface in the formation at all times so that filtration and borehole stability continue. This often means continually adding slurry stock to the borehole to replace slurry lost by seepage into the formation. Since the unit weights of PAM slurries in proper operational condition are essentially equal to that of water, allowing the head in a polymer slurry column to drop to the piezometric level in the formation, even momentarily, may initiate hole sloughing. A good rule of thumb is to keep the level of polymer slurry at least 10 ft above the piezometric surface at all times. An equally good rule is to place the slurry in the borehole before the piezometric level is reached so that sloughing or raveling

does not have a chance to start. Some of the more advanced polymeric technologies are designed to limit filtration losses, but it is still imperative to maintain positive fluid pressure on the borehole sidewalls for sidewall stability.

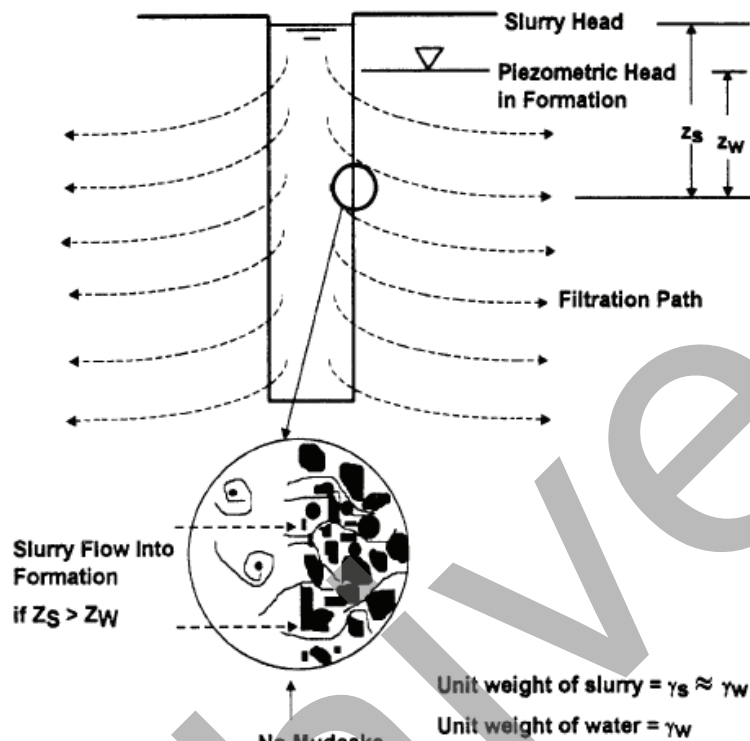


Figure 7-4 Stabilization of Borehole by the Use of Polymer Drilling Slurries

Long-chain PAM molecules tend to wrap around clay and silt particles that are mixed into the slurry during the drilling process. This behavior is illustrated in Figure 7-3b. The polymers attach first to the more active clays in the cuttings, producing small groups of fine particles which then bond to less active clay minerals, such as illites and kaolinities, and then finally to silts. The resulting agglomerated particles tend to settle out of suspension slowly and accumulate as mushy sediments on or near the bottom of the borehole. Some of the agglomerated particles also tend to float on the surface of the slurry or stay in suspension, at least temporarily, and may appear as a bulky material that some observers have termed "oatmeal". Requiring a period of time after completion of the excavation prior to final cleanout allows this material to settle to the bottom of the slurry column where it can then be removed. This period can range from about 30 minutes up to several hours. If the sediments are not properly cleaned from the excavation they will be at least partially lifted upward by the initial charge of concrete and will appear at the surface on top of the concrete. When drilling in silty soils, some 'oatmeal' is inevitable, and in some types of polymers this process appears to be accelerated by excessive hardness in the slurry water.

Some of the recently-introduced advanced polymer slurries provide for more efficient settlement of colloidal fines. The three-dimensional lattice structure allows colloidal fines, silts, and fine sands to continuously wrap into larger agglomerated masses. These agglomerates fall rapidly to the base of the shaft throughout the excavation process. Being larger masses they are readily removed from the slurry column. The degree of water hardness that can be tolerated by various polymer products depends on the

specific design of the product; therefore, the manufacturer should be consulted regarding how water hardness should be controlled. Control of makeup water hardness is discussed briefly in Section 7.3.2.

A fundamental difference between polymer and bentonite slurries is that a polymer slurry will not suspend colloidal fines or particles of sand size or larger for any significant time. In some types of synthetic slurries, in particular PAM's, these coarse-grained particles will settle to the bottom of the slurry column (referred to as sedimentation) and must be removed prior to placement of concrete. This behavior is not a disadvantage or problem, but it must be understood and the appropriate cleanout techniques must be employed to ensure proper placement of concrete under polymer slurry. In most cases, it is sufficient to allow the slurry properties, discussed later, to reach a steady state at mid-height and in the bottom 6 ft of the borehole before final clean-out and placement of the rebar cage and concrete.

Any situation that results in entrapment of excessive silt in a polymer slurry creates the potential for poor slurry displacement when concrete is placed. Some contractors report that sand content tests do not predict the occurrence of silt entrapment. Increases in slurry density and color change are usually the key indicators. A practical solution for silt entrapment in polymer slurry is to replace the slurry completely just prior to concreting. Slurry which has been replaced can then be treated in tanks for further use.

Disposal of synthetic polymer slurries must conform to all applicable local regulations governing the safe disposal of job-site materials. In some cases it is possible to obtain permission from the local municipality to dispose of polymer slurry through the sewer system or to transport the slurry directly to the waste water treatment plant. Either of these options typically requires sending a representative sample to a testing lab to certify its composition and then contacting officials with the waste water treatment plant where the waste stream will be treated, to obtain permission. Polymer slurry may require treatment prior to disposal. The simplest form of treatment is dilution with water. Some agencies may require the slurry to be depolymerized (or 'broken') which can be achieved by the addition of an oxidizer, such as calcium hypochlorite. In the past, sodium hypochlorite has been used as an oxidizer, but the resulting chemical reaction can produce secondary contaminants, and the amount of oxidizer required is 10 to 12 times the amount of calcium hypochlorite needed to achieve the same result. Another possible disposal scenario is for the polymer slurry to be covered under the permit of the general contractor for waste materials to be disposed of on-site. This may also require dilution with water, and is also subject to restrictions pertaining to the slurry entering surface water, such as lakes and streams. In all cases, it is the responsibility of the contractor to determine the applicable regulations, obtain the necessary permits, and to dispose of the polymer slurry appropriately.

### **7.2.3 Blended Slurries**

Blended slurries consist of mixtures of minerals (generally bentonite) and polymers. In some situations blended slurries can be designed and used in a manner that takes advantage of the beneficial characteristics of each. However, this is a specialty field that requires expertise beyond what is normally available on most drilled shaft projects. Specifications developed for mineral slurries or commercially available polymer slurries likely will not be suitable for blended slurries. Blending is not recommended unless those involved have the knowledge and experience to determine appropriate specifications and quality control/quality assurance procedures for its use, given the site-specific ground conditions.

Blended bentonite and polymers are also available as packaged products that are marketed as "extended" bentonites. The polymer additive helps less bentonite produce a given amount of slurry, which is an economic consideration, since high-quality bentonite is becoming harder to find. However, the properties of extended bentonites can be affected significantly by the type of polymer used, and it is important for



the end user (contractor) to work closely with the bentonite supplier to understand the composition and the behavior of the resulting slurry.

#### **7.2.4 Example Applications and Limitations of Drilling Fluids in Drilled Shaft Construction**

As with all drilled shaft construction methods and materials, success depends upon proper execution by the contractor and on the suitability of the methods and materials for the ground conditions. Competent contractors experienced in the use of drilling fluids are best-qualified for assessing whether slurry methods are appropriate for a specific project and for selecting the most suitable type of slurry. Nevertheless, engineers and owners should be well-informed on issues important to construction with drilling fluids, such as the general suitability of a site for slurry, and potential problems. For example, use of drilling fluid in certain geologic environments, such as karstic limestone or basalt with lava tubes, could result in the loss of large quantities of fluid into cavities. The program of subsurface exploration should reveal whether such geologic conditions exist, and the appropriate construction planning should be done in the event the chance for encountering such features is high. It is also important to recognize that use of drilling fluids is both a science and an art. Mistakes can be made in the application of mineral, polymer, or blended slurries, as with any method of construction of deep foundations, and the last section in this chapter discusses some of the common mistakes and methods of avoiding them. However, there are numerous examples of circumstances where drilling slurry has been used with outstanding success. A few are given here.

1. A site was encountered where the soil consisted of very silty clay, which was not sufficiently stable to permit the construction of drilled shafts by the dry method. Bentonite slurry was used, and shafts up to 4 ft in diameter and 90 ft long were installed successfully despite the fact that claystone boulders were encountered near the bottoms of the shaft excavations.
2. A mineral slurry was used to penetrate a soil profile that consisted of interbedded silts, sands, and clays to a depth of about 105 ft, where soft rock was encountered. Drilled shafts with diameters of 4 ft were successfully installed down to the soft rock. A loading test was performed, and the test shaft sustained a load of over 1,000 tons, with little permanent settlement.
3. Three test shafts were constructed with bentonitic drilling slurry in a soil profile containing alternating layers of stiff clay, clayey silt, and fine sand below the water table. These test shafts were all instrumented to measure side and base resistance during the loading tests, which were found to be comparable to the resistances that would have been achieved had the dry method of construction been used. The test shafts were later exhumed, and it was found that the geometry of the constructed shafts was excellent. The information obtained in this test program was then used to design foundations for a large freeway interchange.
4. Two instrumented test shafts, 30 inches in diameter, were installed with PAM polymer slurry in a mixed profile of stiff, silty clay, clayey silt, lignite, and dense sand to depths of up to 51 ft at a freeway interchange site. The contractor allowed the sand in the slurry columns to settle out of suspension for 30 minutes after completing the excavations before cleaning the bases with a clean-out bucket and concreting. The shafts were tested to failure, and the measured side and base resistances were comparable to the values that would have been anticipated in this soil profile with bentonitic drilling slurry.

These are only four examples of the use of drilling slurry in the construction of drilled shafts. To date, tens of thousands of large-diameter drilled shafts have been constructed worldwide with drilling slurry and are performing successfully.

While much is known about the properties of drilling slurries and their effects, success in maintaining borehole stability with a given slurry depends on many factors that are understood qualitatively but not all of which are readily quantified. Some of these are:

- Density of the granular soil being retained. Soils of higher relative density are retained more easily than soils of lower relative density (loose).
- Grain-size distribution of the granular soil being retained. Well-graded soils are retained more easily than poorly graded soils.
- Fines content of the granular soil being retained. Silt or clay within the matrix of sand or gravel assists in maintaining stability, especially with polymer slurries, but fines can become mixed with the slurry, causing its properties to deteriorate. Some contractors look for a fines content of at least 8 percent in order for polymer slurries to perform well.
- Maintenance of positive fluid pressure in the slurry column at all times (Figure 7-1 and Figure 7-2). This factor is especially important with polymer slurries, which have unit weights that are lower than those of mineral slurries and thus produce smaller effective stresses against borehole walls for a given differential head.
- Diameter of the borehole. Stability is more difficult to maintain in large-diameter boreholes than in small-diameter boreholes because of a reduction in arching action in the soil, and because more passes of the drilling tool often must be made to excavate a given depth of soil or rock compared with excavation of a smaller-diameter borehole. Such excess tool activity tends to promote instability.
- Depth of the borehole. For various reasons, the deeper the borehole, the more difficult it is to assure stability. Evidence suggests that difficulties have occurred using PAM polymer slurries at some sites where granular soils were encountered at depths greater than 80 ft. However, some of the newer polymer systems have been used successfully at greater depths. It is the responsibility of the user to insure that they are incorporating a polymer system designed for the conditions being encountered.
- Time the borehole remains open. Boreholes in granular soil have been kept open and stable for weeks with the newer polymer slurries as compared to days with bentonite and PAM polymer slurries. However, in general, stability decreases with time. Ground stresses, which affect axial resistance in the completed drilled shaft, decrease with time as long as the borehole remains open, regardless of whether the borehole remains stable.

## **7.3 MATERIAL CHARACTERISTICS AND SLURRY MIX DESIGN**

The general principles important to the use of drilling fluids were introduced in the previous section. This section provides a more in-depth description of the most widely-used slurry materials, bentonite and synthetic polymers, with a focus on properties that are most important in material selection and slurry mix design, and their influence on the performance of drilling fluids for drilled shaft construction.

### **7.3.1 Bentonite**

Bentonite has been used extensively for making drilling fluid used in drilled shaft construction and continues to be used widely in some parts of the U.S. Because bentonite is a naturally-occurring material which is mined and then subjected to varying degrees of processing before being supplied commercially,

its properties can vary. It becomes important to consider the source of the bentonite and to conduct screening tests to establish the proper mix of bentonite, water, and additives for a given project. For the interested reader, several excellent references are available in which the chemistry of bentonite and slurries made from bentonite are covered thoroughly (*e.g.*, Darley and Gray, 1988). The focus here is on the practical aspects of bentonite slurry used for drilled shaft construction. The following general observations pertaining to bentonite (and other slurry minerals) will prove to be useful.

- The materials to be selected for a particular job will depend on the requirements of the drilling operation. Different types of drilling fluids are required to drill through different types of formations. Some of the factors that influence the selection of drilling fluid are economics, contamination, available make-up water, pressure, temperature, hole depth, and the materials being penetrated, especially pore sizes and the chemistry of the soil or rock and the groundwater.
- An economic consideration for the contractor is the "yield" of the mineral used to make the slurry. The yield is the number of barrels (42 gallons) of liquid slurry that can be made per ton of the dry mineral added to achieve a slurry with a viscosity of 15 cP (described later).
- The best yield comes from sodium smectite ("Wyoming bentonite"). Other natural clays give very low yield and, for reasons discussed previously, are typically not used in drilled shaft construction. Calcium smectite yields a lesser amount of slurry per unit of weight than Wyoming bentonite because it is hydrated by only about one fourth as much water as Wyoming bentonite.
- The yield of Wyoming bentonite has been dropping due to the depletion of high-quality deposits in the areas where it is mined. The yield of some pure bentonite products is now as low as 50 barrels of slurry per ton of dry bentonite. High-quality Wyoming bentonite that will produce a yield of 100 bbl./ton is still available, but at a premium price. In recent years, suppliers have been producing Wyoming bentonite mixed with polymer "extenders" to increase the yield. In fact, most bentonite products available today are actually mixes of bentonite and some type of polymer, ranging from natural polymers such as cellulose derived as a waste product of paper and pulp processing, to synthetic polymers. Some suppliers are also chemically modifying calcium smectite to give it essentially the same properties as Wyoming bentonite, but the resulting products are relatively expensive.
- The quality of the water that is used to make drilling slurry is important. For bentonitic slurries potable water should be used. Saline water can be used for slurry if attapulgite or sepiolite clay is used instead of bentonite. These clays derive their viscosity from being vigorously sheared by specialized mixing equipment designed to accelerate the suspension of such clays. As described previously, bentonite, with proper preparation, can be used for limited periods of time while drilling in salt water if the makeup water is fresh and if additives are applied to inhibit migration of salt. The key is that makeup water should be uncontaminated.

The detailed design of a bentonite slurry (particle size, additives, mixing water, mixing technique, and time) and the interaction of the slurry with the chemicals in the makeup water, as modified by the conditions in the ground through which the shaft is drilled, affect the thickness and hardness of the filter cake that is built up, as well as the gel strength of the fluid slurry. It is good practice for the contractor to conduct tests on trial mixes of the proposed mineral slurry to determine these properties. The test and device used to determine cake thickness and filtration loss is standardized by the American Petroleum Institute (API) and is referred to as the API filter press (API, 2003). A small amount of slurry is forced through a standard piece of filter paper under a differential pressure of 100 psi for a fixed period of time (typically 30 minutes). It is advisable that the resulting filter cake be no more than about 1/8 inch thick and that the filtration loss (amount of slurry passing through the filter paper) be less than about 10 mL. Higher values of cake thickness from this standard test may indicate that a substantial thickness of filter

cake will remain on the sides of the borehole, and will perhaps attach to the rebar, after the concrete has been placed. This condition is undesirable, as it will reduce the load transfer between the drilled shaft and the soil formation to a magnitude below that which will be calculated using the procedures in Chapter 13. Filtration loss is a measure of the effectiveness of the mineral slurry in controlling loss of fluid to the formation, which is an economic factor for the contractor, but in and of itself is not critical to the drilled shaft as long as the borehole remains stable. Some slurry suppliers recommend deviating from the API standardized procedure for drilled shaft applications, because the high magnitude of pressure (100 psi) causes a thin, highly compressed filter cake. Conducting the test at pressures in the range of 8 to 14 psi may model the field conditions of drilled shaft construction more realistically.

The gel strength of bentonite slurry should also be measured and adjusted as necessary as the trial mix is being prepared. The gel strength is the shear strength of the unagitated slurry after hydration with water, has taken place. Measurement of slurry gel strength using a viscometer is described in Section 7.4.4.2. As a standard, the gel strength is measured 10 minutes after vigorous mixing is completed. High gel strength is necessary if it is desired that the slurry be used to transport solids, as in direct or reverse circulation drilling, in which the cuttings are transported to the surface by suspending them in the slurry and pumping the slurry to the surface where the cuttings are removed. However, high gel strengths can be a problem when concrete is being used to displace the slurry. Lower gel strength should be used if the purpose of the drilling slurry is only to maintain borehole stability and to maintain a minimal volume of cuttings in suspension, which is the usual objective of mineral slurries for drilled shaft construction, since the cuttings are usually lifted mechanically. Ordinarily, for this purpose, 10 minute gel strength should be between about 0.2 and 0.9 lb/100 ft<sup>2</sup>. Measurement of gel strength is described in Section 7.4.4.2.

Gel strength, cake thickness, and filtration loss are not usually measured during construction operations unless the slurry begins to perform poorly. Instead, they are monitored indirectly by measuring the viscosity of the slurry by means of a rheometer or "viscometer" (Section 7.4.4.2) or a Marsh funnel, the results of which relate crudely to slurry viscosity.

The unit weight of slurry made from high-quality Wyoming bentonite upon mixing should be between about 64.3 and 66 lb/ft<sup>3</sup> in order to achieve the proper viscosity. Since the unit weight of fresh water is 62.4 lb/ft<sup>3</sup>, about 1.9 to 3.6 lb. of bentonite needs to be added to every cubic foot of makeup water (or about 0.2 to 0.4 lb. per gallon) to produce slurry of proper consistency. Use of less mineral solids in the initial mix will likely make the slurry ineffective at maintaining borehole stability, and use of more mineral solids will produce too much gel strength (excessive viscosity) for the slurry to be flushed effectively by the fluid concrete. The dosage of attapulgitite in a slurry mix should be about the same as for bentonite, but the dosage of bentonite from sources other than Wyoming needs to be about four times as high as for Wyoming bentonite.

Mineral slurry can be improved in some instances by chemical additives. For such cases, the supplier of the bentonite or other product can usually be helpful and should be consulted. A technical representative of the slurry product supplier should be present at the beginning of any important project to ensure that the properties of the slurry are appropriate for the excavation of soils and rocks at the specific site involved, even if special additives are not contemplated by the contractor. The following is a general description of additives available for use with bentonite slurries (LCPC 1986):

- Cake thinners Reduce the free-water content, thus thinning the cake and enhancing its resistance to contamination, and increasing the viscosity of the slurry somewhat. These additives also act as filtrate reducers (below).
- Filtrate reducers Reduce loss of slurry to the formation.

- Anti-hydrating-agent Inhibit the erosion of dispersive clays and clay-based rocks into the slurry and the expansion of expansive clays.
- pH reducers Pyrophosphate acid can be added to lower the pH of the slurry. This additive is of special interest when excavating certain expansive marls in which hydration, which occurs when the drilling slurry is highly basic (pH > 11), can be limited by maintaining the pH value between 7.5 and 8. Maintaining pH below 11 is also necessary to maintain good characteristics of bentonite slurries.
- Weighting agents Barite (barium sulfate), hematite, pyrite, siderite, or galenite may be added to the slurry when it is necessary to resist the intrusion of water under pressure or flowing subsurface water. The specific gravity of the slurry, which is normally around 1.03 to 1.05 upon mixing, may be increased to 2.0 or even greater with these agents, without appreciably affecting the other properties of the slurry (for example, its gel strength and viscosity).

Additives may also affect the yield of the slurry to varying degrees. Again, the assistance of a technical representative of the supplier of the slurry solids and additives is important to ensure that the desired properties are achieved, at least in the initial mixing of the slurry.

Bentonite slurry is strongly affected by the presence of excessive concentrations of positive ions, as are found in very hard water and acidic groundwater, by excessive chlorides concentrations, as are found in sea water, and by organics. Acidic conditions are indicated by pH values that are lower than 7. Some commercial bentonites are packaged with additives that raise the pH of the bentonite-water mixture to 8 to 9 to counteract the effects of minor acid contamination, but excessive acid contamination can lower the pH to a point where the bentonite will flocculate. Bentonite can be used sparingly at low pH (acidic) for short periods of time (pH down to about 5). One function of the manufacturer's technical representative would be to measure the hardness, acidity, chlorides content, and organic content of the mixing water and the groundwater, if necessary, and to recommend conditioners in the event the water is not suited to mixing with the bentonite without modification.

If the soil being excavated is organic, acidic, or saline, the bentonitic slurry may be "killed" (flocculate). The addition of de-flocculants or other measures will be required to maintain proper consistency. Therefore, the critical factor in regard to the materials is that specifications be written to control the slurry as it is manufactured and as it is being used during excavation. Suggestions are given in Section 7.4.5 on the preparation of specifications for mineral slurry.

### 7.3.2 Polymers

Two general categories of polymers have been used in slurries for drilling applications: natural (or semi-synthetic) and synthetic. Naturally-occurring polymers include starches, guar/xanthan gum, welan gums, scleroglucan, and cellulose. For a variety of reasons, most of these materials are not well-suited for producing slurry to be used in drilled shaft construction. Cellulosic polymers (which are a waste by-product of paper manufacturing) are sometimes blended with bentonite to extend the bentonite yield or as additives to reduce the filtration rate of bentonitic slurry (fluid loss into the formation) and inhibit swelling and consequent erosion of clays and shales. Aside from their use as additives, natural polymers are not commonly used in drilled shaft construction. The vast majority of polymer slurries used for foundation drilling today are made with purely synthetic (*i.e.*, manufactured) polymers.

Synthetic polymers used in the drilled shaft industry can be further divided into two broad groups. The first consists of various forms of the hydrocarbon-derived family of chemicals called polyacrylamides, or PAM. These materials are manufactured by combining individual acrylamide molecules (monomers)

through various chemical processes into long chains, hence the term polyacrylamide. In the manufacturing process, negative electrical charge is created on the backbones of the chains through a variety of processes. When these products were first introduced, the process used to adjust the charge density was partial hydrolyzation (addition of OH<sup>-</sup> molecules) and the resulting drilling polymer was referred to as a partially-hydrolyzed polyacrylamide, or "PHPA". However, the processing techniques have changed and partial hydrolyzation is no longer used. The chemical industry term for polyacrylamide is "PAM". The purpose of the negative charge is to promote molecular repulsion, restrict agglomeration (attraction of many molecules into large masses), and keep the molecules in suspension once mixed with water. Polymers used for drilled shaft excavation do not have all of the possible positions for negative charges filled because the surfaces of the polymer chains would be so negatively charged as to be repelled by the soil they are intended to penetrate.

The second category of synthetic polymers used in drilled shaft slurries is highly engineered polymeric materials that involve combinations of acrylamide molecules with other chemicals to form new molecules whose properties are designed to optimize their performance as drilling slurries. These products typically are proprietary and covered by patents. It is not possible to provide detailed information on the composition of these products; however, it must be recognized that these products will exhibit different behaviors than slurries made from PAM products. The specifications used to control properties of slurries made from proprietary polymers may differ from those applicable to PAM slurries. For details of polymer chemistry for any drilling product and for recommended specifications, the contractor should work closely with the manufacturer's technical representatives and/or literature.

Commercial polymer products vary in physical form (dry powder, granules, or liquids) and in the details of the chemistry of the hydrocarbon molecules (molecular weight, molecule length, surface charge density, etc.). No one formulation is likely to be superior in all cases. Many polymer slurry suppliers market several formulations that can be customized for a given site. For this reason, as with mineral slurry drilling, the drilling contractor should employ a technical representative of the polymer supplier to advise on the specific formulation that is best suited for the job at hand. That representative should be present for the drilling of technique shafts and/or the first few production shafts to make sure that the slurry is working as intended and, if not, to make such modifications to the slurry mix and procedures as necessary.

The simpler PAM slurries are especially sensitive to the presence of free calcium and magnesium in the mixing water or groundwater. Excess calcium and magnesium produce what is commonly called "hard water". The total hardness of the slurry mixing water should be reduced to a value in the range of 50 parts per million or less (varies with the specific product used) unless the polymer has been modified chemically to remain stable in high-hardness conditions. If the hardness is too high, polymer chains lose their repulsion and can begin to attract one another and agglomerate, causing the polymer to be ineffective. Total hardness of the slurry can be checked easily by a titration process, in which one or two chemicals are added to a known volume of slurry to change its color and another chemical is titrated into the colored slurry. When the color of the slurry again changes (typically from purple to blue), the volume of the final chemical added to the slurry is read, and the hardness is obtained from a simple calibration chart. Some simpler, though more approximate, methods can also be used for field control of hardness.

Excessive hardness is reduced by thoroughly mixing sodium carbonate ("soda ash") with the slurry until the hardness is within the desired range. Manufacturers of proprietary polymers may supply other softening agents for use with their slurries. Hardness is not usually monitored routinely during construction due to the effort involved; however, pH, which can be measured quickly and easily, should be monitored. The agent that is used to lower hardness also raises pH, so that a check on pH is an indirect check on hardness.

Chlorides also have a negative effect on PAM slurry. PAM slurries tend not to be effective in water having chloride content greater than about 1500 parts per million. Therefore, they are not usually effective in sea water. Sometimes, suppliers' technical representatives can recommend additives or devise mixing procedures to allow the use of polymer slurry in brackish water. The newer polymers tend to be less sensitive to chloride content.

## 7.4 CONTROL OF DRILLING FLUID DURING CONSTRUCTION

### 7.4.1 Mixing and Handling of Mineral Slurry

A variety of procedures are employed for the mixing and handling of mineral slurry. The principal concern is that the slurry characteristics are appropriate during the excavation of the borehole and during concrete placement. The mixing equipment and procedures must satisfy two general requirements: (1) adequate mixing of the mineral with the makeup water, and (2) adequate hydration to form a dispersed, lump-free suspension. A schematic diagram of a complete, appropriate system for mixing and handling bentonite slurry for drilled shafts is shown in Figure 7-5. Two acceptable types of mixers are shown in Figure 7-5b. The mixer identified by  $b_1$  consists of a funnel into which dry bentonite is fed into a jet of water directed at right angles to the flow of the bentonite (a "venturi"). The mixture is then pumped to a holding tank. The mixer identified by  $b_2$  consists of an electric motor, with or without speed controls, that drives a vertical shaft. The shaft has blades attached that operate at a circumferential speed of up to about 260 ft/s and provides excellent mixing of bentonite with water.

Freshly-mixed slurry should be held in storage for a period of time to allow complete hydration. The stored slurry can be re-mixed, if necessary, by pumps, mechanical agitation, or compressed air. The mixed slurry should not be used in drilling until the viscosity has completely stabilized, which usually requires several hours following initial mixing. It is recommended that bentonite be hydrated for 24 hours prior to its introduction to a drilled shaft excavation. Less time, but more vigorous mixing, is required for attapulgite or sepiolite slurries.

Figure 7-5d depicts the common "static" (non-circulation) mineral slurry drilling process. The slurry stored in the storage tank (Figure 7-5c) is carried to the borehole by pump or by gravity with the slurry level in the borehole kept continuously above the level of the piezometric surface in the formation during drilling. When soils with significant amounts of granular material (sand or silt) are being excavated, the slurry may quickly thicken as the particulate matter is placed in suspension. This is not desirable, because (a) the slurry becomes incapable of suspending additional particulate matter, the consequence of which is that the additional particulate matter may slowly settle out of suspension after the borehole is cleaned and as the concrete is being placed, and (b) the slurry may become too viscous to be displaced by rising fluid concrete. This condition can be identified by measuring the sand content, density, and viscosity of the slurry at the bottom of the borehole before concrete placement. Slurry with excessive sand or viscosity must be pumped from the bottom of the borehole to a treatment unit located on the surface for removal of the particulate matter. Simultaneously, fresh slurry meeting all of the sand content, density, and viscosity requirements is pumped from a holding tank on the surface and introduced at the top of the borehole, keeping the level of slurry in the borehole constant.

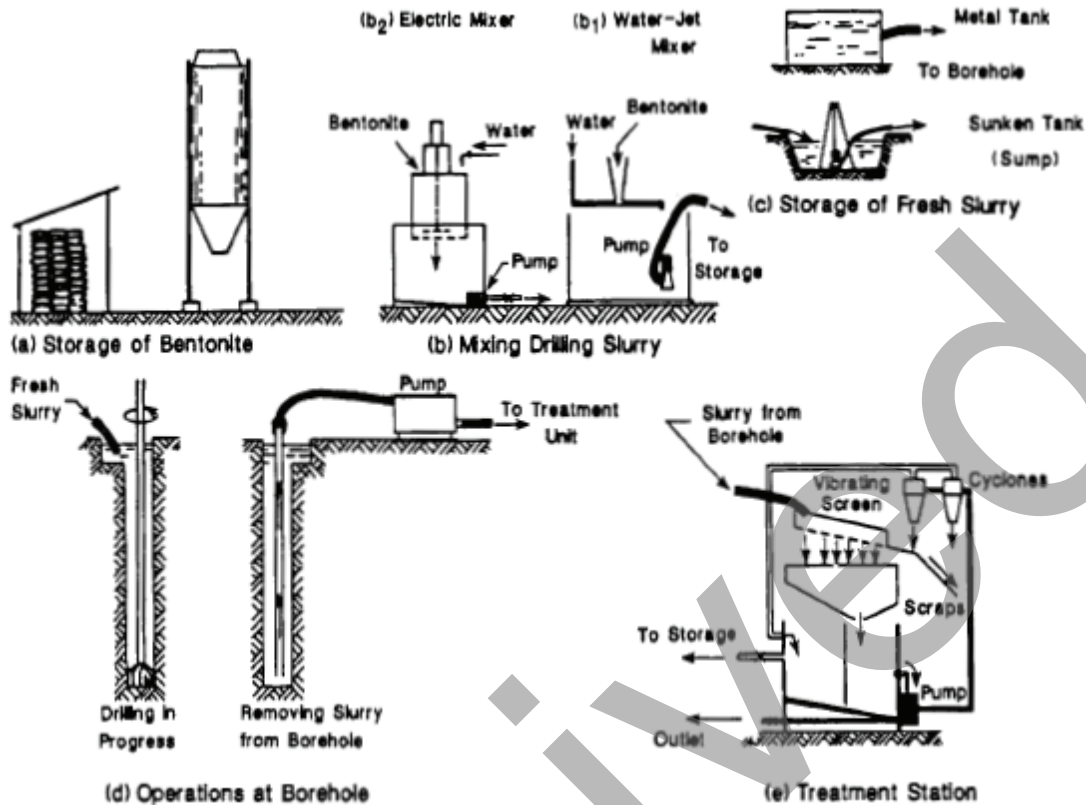


Figure 7-5 Schematic Diagram of Unit for Mixing and Treating Mineral Slurry (after Le Laboratoire Central des Ponts et Chaussées, 1986)

A common procedure for removing the slurry from the bottom of the borehole is to use an airlift. A jet of air at low pressure and high volume is introduced near the bottom of an open pipe, which is placed near the bottom of the borehole. As the air flows upward, the reduced pressure in the pipe causes slurry to enter and a mixture of air and slurry will be blown up the pipe to the surface by the air lift. Air lifting is also effective in cleaning loose sediments and agglomerated slurry from the bottom of the borehole if a diffuser plate is placed on the bottom of the pipe to distribute the suction equally around the bottom of the borehole. A submersible pump can also be used for this purpose. With either method, the rate of the fluid flow should lift all sediments in the slurry from the borehole.

When the hole is advanced through primarily cohesive soil, the slurry may not thicken appreciably during drilling, unless the clay erodes. In such a case, exchange of the slurry in the borehole may not be necessary. However, agitation of the slurry (as with the auger) is still desirable to ensure that particulate matter stays in suspension. This action is especially important with attapulgite or sepiolite, which do not suspend solids as readily as bentonite. In this case, the slurry needs to be recovered from the hole only once (as the concrete is placed) and directed to the treatment unit before reuse or discarded.

The contaminated mineral slurry is moved to a treatment unit, Figure 7-5e, consisting of screens and hydrocyclones. The slurry first passes through the screens (usually No. 4 size), where the large-sized sediments are removed, and then is pumped through the cyclone unit where the small-sized material is removed by vigorously spinning the slurry. Most hydrocyclones are capable of removing virtually all sand-sized particles. Some units are equipped with smaller hydrocyclones that also remove silt, although



several passes through the hydrocyclones may be necessary. Silt removal can be just as important as sand removal for reused mineral or blended slurries, because suspended silt can cause the viscosity, density, and filtration rate to increase, rendering the slurry ineffective.

The cleaned ("desanded") slurry is pumped back to a holding tank where it should be tested. Since slurry drilling ordinarily involves some loss of slurry to the formation, some amount of fresh slurry is usually mixed with the desanded slurry at this point. If the used slurry is to be discarded without treatment, it is essential that approved methods be used for disposing of the slurry.

For a small job where it is uneconomical to bring in a full treatment unit to the jobsite, the contractor may wish to fabricate a screen system that can be cleaned by hand and to obtain a small cyclone unit to do the final cleaning. As stated earlier, another procedure that can be employed on some jobs where relatively little sand is present in the formation being drilled is to employ the static drilling process, without any treatment of the slurry, as long as the sand and silt content in the slurry do not become excessive. A clean-out bucket can be lowered to the bottom of the borehole and rotated to pick up sediments that have settled out of the slurry. This kind of cleaning operation, although time-consuming, is necessary to prevent significant amounts of sediment from either being trapped beneath the concrete as it is introduced into the borehole or from collecting at the top of the concrete column during concrete placement. The slurry that is flushed out by the placement of the fluid concrete can sometimes be reused several times if the specified ranges for density, viscosity, sand content and pH can be maintained. Attapulgit and sepiolite slurries are treated much like bentonite slurries, except that very vigorous mixing for a long period of time is required. Once the mineral is thoroughly mixed with the makeup water, the slurry can be introduced directly into the borehole, as these minerals do not hydrate with water and so do not need to be held for several hours for hydration, like bentonite, before introducing them into the borehole.

Certain procedures have no place in drilled shaft construction; for example, dumping dry bentonite into a water-filled excavation and stirring the mixture with the auger. This procedure produces an ineffective slurry that contains clods of dry, sticky bentonite that fail to stabilize the borehole because the individual bentonite plates are not available to form the mudcake. Furthermore, the clods can become lodged in the rebar or against the borehole wall and produce a defective drilled shaft.

#### **7.4.2 Mixing and Handling of Polymer Slurry**

Methods for mixing of polymer slurries can vary and the supplier should always be consulted for recommendations. Emulsified PAM products can be mixed by circulating between tanks, as shown in Figure 7-6. High-shear mixing of polymers results in "chopping" of the long-chain molecules, rendering the slurry ineffective, and should be avoided. Additional measures that help to minimize the potential for damage to polymer slurries include in-line mixing (Figure 7-7a) and the use of splash plates for transporting between tanks (Figure 7-7b). For pumping, diaphragm pumps are recommended. It is strongly recommended that a technique shaft be constructed to test the effectiveness of the polymer slurry prior to constructing production shafts.

Soda ash or another hydroxide hardness reducer is almost always added to the makeup water during mixing to control the hardness of the water, which simultaneously adjusts the pH of the polymer slurry to a high value. Note that soda ash should not be used with certain proprietary polymer products, and the supplier should be consulted on proper treatment of mixing water.



Figure 7-6 Field Mixing Polymer Slurry by Circulating Between Tanks

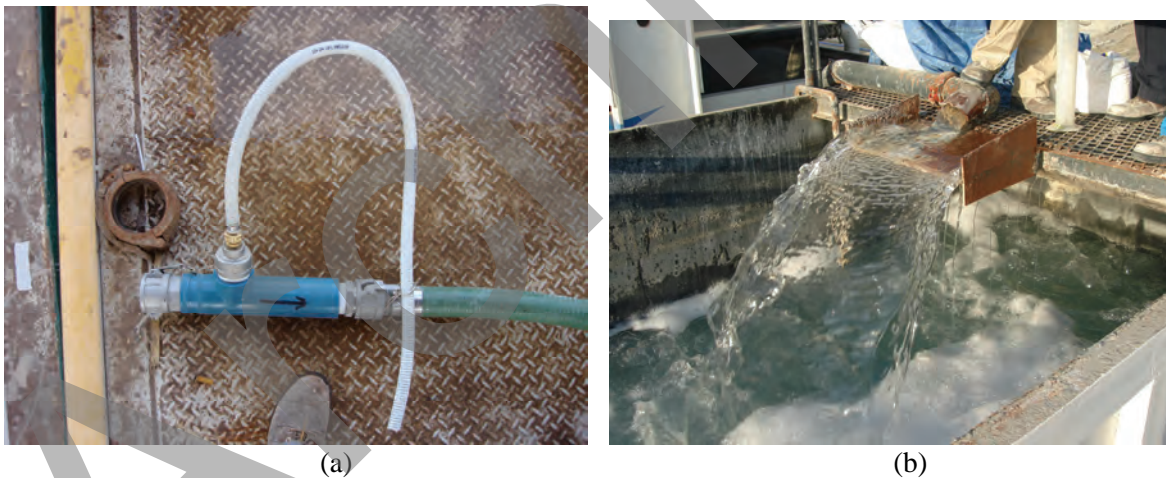


Figure 7-7 Techniques for Handling Polymer Slurry; (a) In-line Mixing Device for Adding Polymer; (b) Splash Plate for Transporting Slurry

Polymer slurries cannot be cleaned effectively using the equipment intended for mineral slurries, shown in Figure 7-5. The polymer strands are broken down by vigorous mixing in hydrocyclones, and polymers tend to "gum up" the components of the treatment plant. Instead, the cleaning process is adapted to the concept that polymer slurries do not suspend soil particles. By allowing sedimentation to occur, soil particles are concentrated at the bottom of the slurry column. The sand content at the bottom of the borehole will stabilize at a small value (usually less than 1 per cent by volume) after the slurry column is allowed to stand without agitation for a period of time, for example, about 30 minutes to 2 hours in

boreholes less than 65 ft deep. The sediments collected at the bottom of the slurry column are then removed with a clean-out bucket or airlift. Slurry that is subsequently flushed out of the borehole by the rising column of fluid concrete is then essentially clean, although good practice is to store it for a few hours in a tank on the surface to permit small amounts of solids still in suspension to settle out. The supernatant polymer can then be reused in drilling subsequent boreholes after checking its properties and adding fresh slurry, if necessary.

High silt content can be a challenge in some polymer slurries. Silt particles may remain in suspension for a longer period of time than sand and other coarse-grained particles, and silt may be difficult to remove using the cleanout procedure described in the preceding paragraph. Excess silt in the slurry column creates the potential for poor displacement of slurry by the fluid concrete. Two procedures are common. The first is to completely replace the slurry column with clean slurry prior to placement of concrete. The second is to use additives or specialized polymer products that result in agglomeration of silt and other fines, creating larger particles that will settle to the base of the slurry column where they can be removed by the cleanout techniques described above. Some of the more-recently developed proprietary polymers are designed to agglomerate silt and colloidal particles in order to promote rapid sedimentation. Suppliers and manufacturers of these products should be consulted for project-specific applications.

Full circulation drilling, referred to as either direct or reverse circulation drilling, in which the cuttings are transported by pumping the slurry from the cutting face of the drilling tool continuously to the surface, is possible with mineral slurry. It is not very effective with polymer slurries without special additives since the current generation of polymer slurries do not effectively suspend particulates (cuttings).

Diaphragm-type pumps are generally best for moving polymer slurries from tank to borehole and back. Diaphragm pumps do not damage the polymer chains as severely as centrifugal or piston-type pumps. Any form of mechanical agitation, however, damages the polymer chains to some extent, such that a given batch of polymer slurry cannot be reused indefinitely. This includes air lifting, since the highly turbulent flow of the lifting mechanism can shear the polymer chains excessively. For this reason, air lifting of polymer slurries should be used only for limited durations if the slurry is to be re-used.

Mixing of either polymer or bentonite slurry with Portland cement at any time in the construction process can be detrimental to the slurry because the hydration of Portland cement releases calcium ions in such concentration that the hardness of the slurry may become very high. For this reason the contractor must be very diligent to keep cement out of the slurry and should also minimize the time that the slurry is in contact with the rising column of concrete in the wet method of construction by charging the borehole with concrete at a steady rate. The contractor should use pump lines for polymer or mineral slurry that have either never been used for pumping concrete or have been thoroughly cleaned of concrete.

### **7.4.3 Sampling and Testing**

As stated above and discussed further in Section 7.4.4, mineral and polymer slurries will have certain desirable characteristics which are controlled on the job site according to specifications. Therefore, key properties must be measured to ensure that these characteristics are within the specified range. Sampling and testing will be necessary just before the slurry is introduced into the borehole, during the drilling operation, and always before concrete is placed.

Freshly mixed slurry is sampled from the slurry tanks immediately prior to its introduction into the drilled hole. For this purpose, satisfactory samples may be taken from almost anywhere in the storage tank. The important point is to obtain a sample that is representative of the mixture. During drilling, it is highly

recommended (and should be required by appropriate specifications) that slurry be sampled from the borehole and tested at least every two hours after its introduction. Typically, samples are taken from mid-height and near the bottom of the borehole. Several types of sampling tools are available to obtain a representative sample from the desired location in the slurry column. A device used for this purpose is shown in Figure 7-8. When the sampler is brought to the surface, its contents are usually poured into a plastic slurry cup for subsequent testing.

The following sections describe several items of testing equipment, which can be obtained from any of several oil-field service companies or from bentonite and polymer suppliers.

#### 7.4.3.1 Density

A mud balance (lever-arm scale) is typically used to measure the density, or unit weight, of the slurry. A metal cup that will hold a small quantity of slurry is carefully filled out of the slurry cup and cleaned of excess slurry on its exterior. It is then balanced by moving a sliding weight on a balance beam (Figure 7-9). The density of the slurry is read directly from a scale on the beam in several forms [unit weight (lb/cubic foot, lb/gallon), specific gravity]. The scale should be properly calibrated with water in the cup before making slurry density readings. This device is accurate, and readings can be taken rapidly. The only problem is to obtain a representative sample because the quantity of the slurry that is tested is small in relation to the quantity in a borehole. Therefore, multiple tests are recommended.



Figure 7-8 Device for Downhole Sampling of Slurry (Courtesy of Cetco).



Figure 7-9 Mud Density Balance for Field Measurement of Slurry Density

### 7.4.3.2 Viscosity

Several measures of viscosity are used in specifications. A simple and expedient measurement is made with the Marsh funnel, a simple funnel with a small orifice at its bottom end. The Marsh funnel test provides an index of viscosity rather than a measurement of true viscosity. The test, shown in Figure 7-10, is performed by placing a finger over the tip of the small orifice at the bottom of the funnel (after making sure that the orifice is clean) and filling the funnel with slurry to a line at the base of a screen located near the top of the funnel. When filling the funnel, slurry should be poured through the screen to filter out large solid fragments. The slurry then is allowed to flow out of the funnel through the orifice back into an empty slurry cup, which has a mark denoting one quart, and the number of seconds required for one quart of the slurry to drain from the funnel into the slurry cup is recorded. It should be noted that not all of the slurry will have flowed out of the Marsh funnel at the time one quart has accumulated in the slurry cup. This measure of time, in seconds, is the "Marsh funnel viscosity". Many specifications for drilling slurry rely on the Marsh funnel, and the device allows adequate control of slurry for many jobs.

For slurry mix design, and occasionally on drilled shaft construction projects, a more rigorous and exact measurement of slurry viscosity properties may be required. True viscosity is defined as the shear stress in a fluid divided by the shearing strain rate. The unit of viscosity in the metric system is the poise, defined as stress in dynes per square centimeter required to produce a difference in velocity of one centimeter per second between two layers one centimeter apart. A centipoise (cP) is one hundredth of a poise. An instrument referred to as a "rheometer" or "viscometer," that can be used to measure viscosity of drilling slurries is shown schematically in Figure 7-11. Slurry is contained in the annular space between two cylinders. The outer cylinder is rotated at a known velocity. The viscous drag exerted by the slurry creates a torque on the inner cylinder or bob. This torque is transmitted to a precision spring where its deflection is measured and related to shearing stress. On some commercially-available instruments, shear stress is read directly from a calibrated scale.

The information obtained from a viscometer test is illustrated in Figure 7-12, which shows results from tests on a polymer slurry as presented by Ata and O'Neill (1997). The shear rate is read directly in revolutions per minute (rpm) but can be converted to shear strain rate in 1/seconds by multiplying the number of rpm's by 1.703. The shear stress is read in lb/100 sq. ft. This value is converted to dynes/sq. cm by multiplying the shear stress reading in lb/100 sq. ft by 4.79. Measurements of shear stress are made at varying strain rates, starting at 3 rpm ( $5.11 \text{ sec}^{-1}$ ), to progressively higher rates, including 300 rpm ( $511 \text{ sec}^{-1}$ ) and 600 rpm ( $1022 \text{ sec}^{-1}$ ), which are the standard rates for testing bentonitic slurries.



Figure 7-10 Marsh Funnel Test for Field Evaluation of Slurry Viscosity

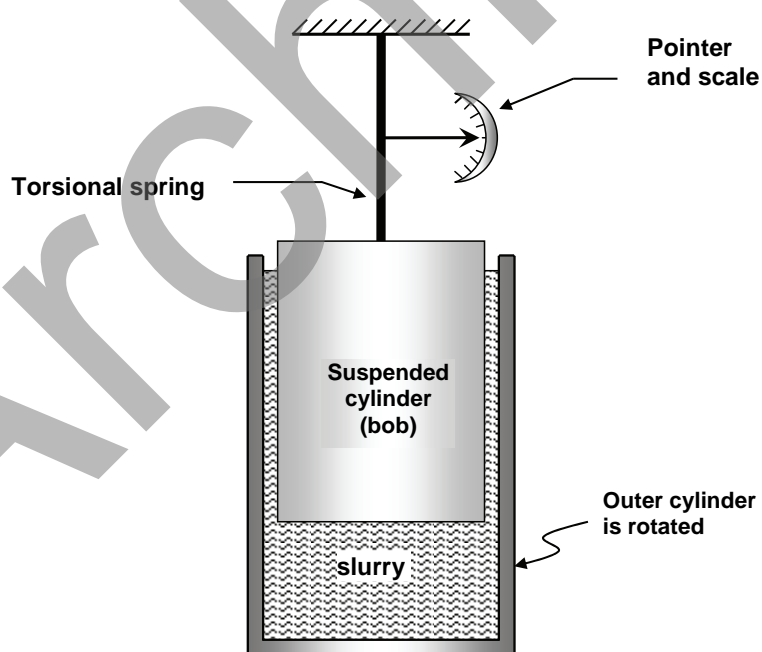


Figure 7-11 Schematic of Slurry Viscometer

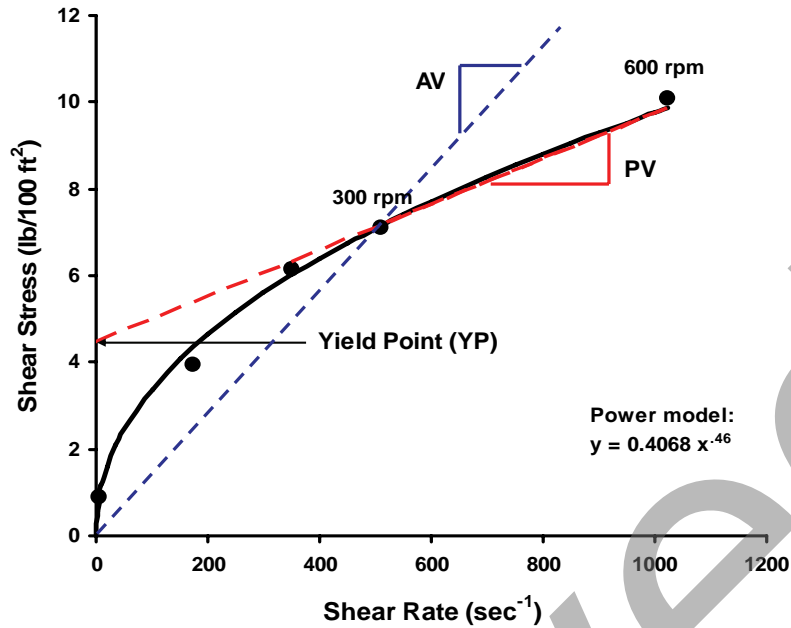


Figure 7-12 Interpretation of Data from a Viscometer Test (after Ata and O'Neill, 1997)

As the shear strain rate is increased by increasing the rpm of the container, the shear stress increases. The resulting relationship between shear strain rate and shear stress, shown by the solid line in Figure 7-12, is usually nonlinear and can be approximated by a simple power function equation. For the example in Figure 7-12 a best-fit relationship is presented in which  $y$  is the shear stress in lb/100 sq. ft, and  $x$  is the shear strain rate in  $\text{sec}^{-1}$ . This power function model of the curve is termed a "rheological" relationship. It is usually more highly nonlinear for polymer slurries than for bentonitic slurries. The exponent, in this case 0.46, is referred to as the " $n$ " value for the slurry.

The following additional parameters are determined from the rheological curve as measured in a viscometer test:

- **Yield Point (YP):** a straight line is drawn between the two points on the curve corresponding to rotational speeds of 300 rpm (strain rate =  $511 \text{ sec}^{-1}$ ) and 600 rpm (strain rate =  $1022 \text{ sec}^{-1}$ ). This straight line presumes that the slurry obeys a "Bingham plastic model" law, which is approximately correct for mineral slurries, and is the dashed red line in Figure 7-12. This line is projected back to zero strain rate, and the intercept with the ordinate defines the yield point, or the apparent shear stress at zero strain rate.
- **Plastic Viscosity (PV):** slope of the straight line used to determine the yield point; normally expressed in units of centipoise (cP), Equation 7-1 can be used to obtain the PV in cP.

$$PV \text{ (cP)} = \left[ \frac{(\tau_{600} - \tau_{300}) 4.79}{511 \text{ sec}^{-1}} \right] \times 100 \approx \tau_{600} - \tau_{300} \quad 7-1$$

in which  $\tau_{600}$  = shear stress measured at 600 rpm and  $\tau_{300}$  = shear stress measured at 300 rpm. The units for  $\tau$  in Equation 7-1 are lb/100 ft<sup>2</sup> (as read from the viscometer).

- **Apparent Viscosity (AV):** slope of a straight line drawn through the origin to a specified point on the curve (at 300 rpm as shown in Figure 7-12, or more commonly at 600 rpm on a direct-reading viscometer). The AV is also expressed in cP and is calculated as follows:

$$AV(\text{cP}) = \frac{4.79 \times \tau_{\text{desired strain rate}}}{\text{strain rate in sec}^{-1}} \times 100 \quad 7-2$$

where  $\tau$  is the shear stress (lb/100 ft<sup>2</sup>) at the same strain rate as in the denominator.

- **Gel Strength:** the shear stress generated at a rotational speed of 3 rpm by testing the slurry after it has been allowed to stand unagitated for a given period of time, usually ten minutes. In some mineral slurries the 10-minute gel strength can be near the yield point, but the 10-minute gel strength is always considerably less than the yield point in synthetic polymer slurries.

The slurry shown in Figure 7-12 exhibits the following rheological properties:

$n = 0.46$	AV = 97 cP @ 3 rpm
YP = 4.48 lb/100 ft <sup>2</sup>	AV = 4.7 cP @ 600 rpm
PV = 2.69 lb/100 ft <sup>2</sup>	gel strength = 0.86 lb/100 ft <sup>2</sup> .

This same slurry also exhibited a Marsh funnel viscosity of 44 sec/quart and was used successfully to excavate 70-ft deep, 3-ft diameter boreholes for drilled shafts that subsequently exhibited values of unit side resistance that equaled or exceeded the predicted values obtained from the design methods in Chapter 13. The subsurface consisted of overconsolidated stiff clay to stiff very silty clay and medium dense silty sand with water table depths of about 10 ft (Ata and O'Neill 1997).

Traditionally, when viscometers have been used to monitor the rheological properties of mineral slurries for drilled shaft construction, the slurry properties that are controlled are the 10-minute gel strength and/or the YP, and occasionally the PV.

Beresford et al. (1989) suggest that polymer slurries should be controlled by monitoring  $n$  and the AV's at 3 rpm (corresponding to the gel strength) and 600 rpm. The value of  $n$  for polymer slurries should be relatively low, which indicates that the slurry tends to thin rapidly on the application of increased shear strain rates. Beresford et al. also suggest that the AV of the slurry at 3 rpm be as high as 250 cP in order to maintain hole stability with the polymer slurry in a static condition in the borehole. However, they do not present evidence that such high values of AV in the drilling slurry result in acceptable magnitudes of unit side shear in completed drilled shafts. Beresford et al. also suggest that the AV at 600 rpm be no greater than about 12 cP so that the slurry will flow readily to the top of the borehole when displaced by the fluid concrete.

### 7.4.3.3 pH Value

The pH of the slurry is an indicator of the degree of acidity or alkalinity of the slurry. Maintenance of a proper range of pH is important to the proper functioning of the slurry and is an indicator of the effectiveness of anti-hardness additives. For example, neutral-to-acid pH (7.0 or lower) can reflect conditions in a borehole that is being drilled through an acidic fill and that a bentonite-based slurry may



be in danger of flocculating, or it could indicate that a polymer slurry is mixing with acidic groundwater and is in danger of agglomerating. Values for the allowable range of pH are presented in Section 7.4.5. The pH can be determined readily by the use of pH paper or by a pocket pH meter. The pocket pH meter, which is the size of a large pencil, is more accurate and is easy to use, but it must be calibrated often against a standard buffer solution.

#### 7.4.3.4 Sand Content

The material retained on a No. 200 screen (74 microns) is defined as sand. Prior to concrete placement, sand content of mineral slurry should not exceed 4 percent by volume. Sand content is measured using a standard API (American Petroleum Institute) sand content kit by taking a slurry sample of 100 mL. A photograph of an API sand content test kit is shown in Figure 7-13. The sample is usually taken from the slurry cup after stirring vigorously to make sure all of the sand in the original sample in the cup is uniformly distributed in the suspension from which the 100 mL sample is taken. The slurry sample is diluted with water and then passed through a No. 200 stainless steel screen. The sand from the slurry is retained on the screen. That sand is then backwashed from the screen into a burette with a graduated, conical base, and the sand content in percent by volume is obtained by reading the scale on the burette.

When testing polymer slurries for sand content, particularly if the soil being drilled contains dispersive clay or silt that can be put in suspension temporarily during drilling and become entangled with the polymer strands, it is important that the slurry be washed over the No. 200 screen with a mixture of household bleach containing sodium hypochlorite and water (perhaps 50/50 by volume), several times if necessary, to detach the polymer strands from the soil. Otherwise, the clay/silt-polymer assemblages will be registered as sand. In any event, it is important that the final wash water in the burette be clear. Otherwise, the washing process should be repeated until the wash water becomes clear before making the sand content reading.



Figure 7-13 Photograph of Sand Content Test Apparatus (Courtesy of J. Berry)

#### **7.4.3.5 Hardness**

Hardness of mixing water or groundwater is measured by a titration process using a standard API kit that can be obtained for this purpose. A small sample of the water is put into an evaporating dish, and chemicals are added to change its color, usually to purple. An amount of another chemical sufficient to turn the color of the water to a target color, usually blue, is then released from a graduated burette (titrated) into the water, and the volume required for the color change measured. The hardness is then determined from a table provided with the kit from the measured volume of the titrated chemical. A simpler, but less accurate, field kit for hardness is also available. This kit requires that only one chemical be added to the water in order to estimate hardness.

#### **7.4.3.6 Free Water and Cake Thickness**

A device called a filter-press is commonly used for this test. The device consists of a small slurry reservoir that is installed in a frame, a filtration device, a system for collecting and measuring a quantity of free water, and a pressure source. The test is performed by forcing slurry through a piece of filter paper under a pressure of 100 psi for a period of 30 minutes. The free water that is recovered is measured in cubic centimeters, and the thickness of the cake that is formed is measured to the nearest millimeter. Before measuring the cake thickness, any superficial slurry that is not part of the filter cake is washed away.

#### **7.4.3.7 Shear Strength**

The shear strength of mineral slurry is influenced by the percentage of mineral that is present, by the thoroughness of mixing, and by the amount of time since agitation. The shear strength at a given time can be measured by use of a device called a shearometer. A determination by the shearometer merely involves the rate at which a thin-walled cylinder will settle in a beaker of slurry. While the shearometer is easy to use, Holden (1984) reports that it is difficult to obtain repeatable readings. The shear strength test is not commonly performed for drilled shaft slurries but can be of aid in diagnosing problems on occasion.

#### **7.4.3.8 Comments on Field Testing of Drilling Slurries**

The purposes of field tests on drilling slurries are to assure that the drilling slurry has the necessary properties to

- Maintain hole stability
- Minimize relaxation of ground stresses
- Leave the sides and base of the borehole in a condition of minimum contamination.

Overall, the field testing of drilling slurries is not difficult. The tests and the skills can easily be mastered by most State DOT inspectors, or the tests can be performed by the contractor's personnel with oversight by a State inspector. Testing personnel should be familiar with published standardized procedures (API 2003).

Not all of the tests described above need to be performed on every drilled shaft on every project. Some of the tests for slurry are time-consuming and in some cases could actually result in poor work because of the inevitable delays that would result as testing is being done. In an ideal situation, all or most of the tests described above would be conducted on trial batches of slurry made from the makeup water available on a given site, using the particular type and brand of slurry material being considered for the drilling operation, and perhaps adding site soils to the slurry mix to determine if mixing the site soils with the slurry affects the slurry's properties. Then, considering the job-specific requirements (drilling in large-grained, open-pored soils; drilling in rock; drilling in clean, loose sand; equipment available, etc.), job-specific specifications are developed. Typically, however, standard specifications that work in most cases are followed, and the tests required by those specifications are conducted to monitor the slurry. The user of standard slurry specifications should be aware that occasionally soil and/or water conditions could exist at any site, or slight changes in formulation of the drilling slurry product being used may occur that may render the standard specifications, and the test values required by the specifications, invalid. The user of the slurry, ordinarily the drilled shaft contractor, should then be prepared to design the slurry to accommodate the soil and water conditions at the jobsite and to arrive at job-specific specifications, perhaps through modification of the standard specifications that will need to be approved by the agency.

Once acceptable slurry mixes and job-specific specifications have been developed for a particular project, testing is ordinarily performed during production drilling, on representative samples, to assure that slurry properties, once established, do not change, and these tests are generally minimal. Tests performed for monitoring production drilling are generally the density test, the Marsh funnel viscosity test, the pH test, and the sand content test.

#### **7.4.4 Specifications for Drilling Slurry**

A number of agencies and writers have made recommendations about the desirable properties for bentonitic slurries for drilled shafts. Valuable references on the subject of bentonite slurries include those developed by engineers with Cementation, Ltd., in the United Kingdom (Fleming and Sliwinski, 1977), and a detailed set of recommendations given by the Federation of Piling Specialists (1975), also in the United Kingdom. The FPS specifications have been adopted by a number of owners as being adequate for most jobs involving the use of drilling slurry. Other detailed sets of bentonite slurry specifications are given by Hutchinson et al. (1975), Hodgson (1979), and Majano et al. (1994).

The following point is emphasized: no “standardized” set of slurry specifications, including those presented in this manual, are applicable to every set of conditions encountered in drilled shaft construction. Specifications should be tailored to fit the requirements of a particular job at a particular location. Standardized specifications, however, are still useful in that they reflect the collective experience of the drilled shaft industry and provide a starting point for agencies with little experience in slurry construction. The ranges of properties specified in standardized recommendations are sufficiently wide to cover a wide range of conditions typically encountered in practice.

TABLE 7-1 and Table 7-2 present general specifications for use with mineral slurries (TABLE 7-1) and PAM-derived polymer slurries (Table 7-2). These tables are adapted from the AASHTO Construction Specifications (AASHTO, 2008) and they also appear in the drilled shaft construction specifications described in Chapter 18. The specifications in TABLE 7-1 apply to either sodium smectite (bentonite) or attapulgite and sepiolite slurries. Attention is again called to the fact that these specifications may need to be modified for job-specific requirements. For example, the specification in TABLE 7-1 for sand content up to 4 percent prior to concrete placement is appropriate in most cases, but in larger shafts (> 6 ft

diameter) 4 percent may be too high to permit full displacement by concrete. One simple, although not always sufficient, axiom to follow is that the most important characteristic of a mineral slurry is its density and that the slurry should be only dense enough to maintain a stable borehole.

With particular reference to Table 7-2, a wide range of polymer products is available and the range of properties specified in the table is typical for many of the PAM products on the market at the present time (2009). Adjustments may be necessary and appropriate, based on recommendations provided by the polymer supplier or manufacturer, and taking into account job-specific conditions and new products. For example, some of the proprietary polymers now on the market operate optimally at Marsh funnel viscosities up to 150.

**TABLE 7-1 RECOMMENDED MINERAL SLURRY SPECIFICATIONS FOR DRILLED SHAFT CONSTRUCTION (AASHTO, 2008)**

Property of Slurry (units)	Requirement	Test Method (API Standard Method)
Density (lb/ft <sup>3</sup> )	64.3 to 72	Mud Weight Density Balance (API 13B-1)
Viscosity (sec/quart)	28 to 50	Marsh Funnel and Cup (API 13B-1)
pH	8 to 11	Glass electrode pH meter or pH paper strips
Sand Content immediately prior to concrete placement (percent by volume)	≤ 4.0	Sand Content (API 13B-1)

**TABLE 7-2 RECOMMENDED POLYMER (PAM) SLURRY SPECIFICATIONS FOR DRILLED SHAFT CONSTRUCTION (AASHTO, 2008)**

Property of Slurry (units)	Requirement	Test Method (API Standard Method)
Density (lb/ft <sup>3</sup> )	≤ 64	Mud Weight Density Balance (API 13B-1)
Viscosity (sec/quart)	32 to 135	Marsh Funnel and Cup (API 13B-1)
pH	8 to 11.5	Glass electrode pH meter or pH paper strips
Sand Content immediately prior to concrete placement (percent by volume)	≤ 1.0	Sand Content (API 13B-1)

Water is sometimes used to maintain stability by simply offsetting the hydrostatic or artesian groundwater pressure, thereby preventing inflow of groundwater to the borehole. For example, a borehole in sand that is cased could have basal stability issues as groundwater from outside the casing seeps upward. Maintaining water levels inside the casing above the hydrostatic or artesian level can prevent this type of bottom disturbance. Water is sometimes used in rock to prevent inflow at the base and along the side of

the borehole. However, the addition of water to rock that will swell or soften in the presence of water is not recommended. When water is used as a drilling fluid, it should be kept as clean as possible, and should conform to specifications that limit its density (by mud balance) to 64 pcf and sand content to a maximum of 1.0 percent.

## **7.5 ADDITIONAL DESIGN AND CONSTRUCTION CONSIDERATIONS**

### **7.5.1 Borehole Inspection Under Drilling Fluids**

Construction of a drilled shaft with drilling fluids makes it difficult to inspect the borehole conditions directly, for example, compared to the dry method of construction. However, several tools are available that provide information on borehole conditions. A downhole shaft inspection device, or SID, can be used to provide a remote image of the borehole. The SID is equipped with an underwater camera that can view the bottom of a shaft excavation that is filled with slurry. The SID is described further in Section 19.2.4.

Knowledge of the excavated borehole geometry can be useful for estimating the required volume of concrete, for identifying the locations of over-excavation or caving, assessing the vertical alignment of the shaft, and for the proper interpretation of load test results. Two complimentary tools are available for this purpose. The first is to employ a borehole caliper that can be used to measure the shape of the borehole as a function of depth. Several different types of calipers and their use are described in Chapter 17 on load testing (Section 17.2.1.5). The second involves preparation of a graph showing the actual volume of concrete that is placed versus anticipated volume for small increments of depth (development of a "concreting curve"). Details of constructing such a plot are described in Chapter 9 (Section 9.3.4). This concreting curve will allow the engineer to make a judgment about the possible loss of concrete in an undiscovered cavity and about the possible collapse of the excavation during concrete placement. Such a plot is useful regardless of the method of construction, but the technique is mentioned here because of its particular importance with regard to the slurry methods, in which neither the finished borehole nor the placement of concrete can be observed visually.

The depth of the borehole should be measured immediately after the base is cleaned and compared to the depth attained by the cleaning tools to determine if sloughing has occurred from the borehole walls. Another depth sounding should be made immediately prior to placing concrete, after the cage is placed in the borehole, to ascertain whether soil that has been in suspension has settled to the bottom of the borehole. If such is the case, it would be necessary to remove the cage and re-clean the base of the borehole.

A subsequent plot of the actual volume of concrete placed per increment of depth versus the expected volume computed from the planned shaft dimensions or from the caliper logs in each increment of depth should show excellent agreement. Such information can be of great value to the engineer if questions arise later about the quality of a particular drilled shaft.

### **7.5.2 Influence of Slurry on Axial Resistance of Drilled Shafts**

Geotechnical design of drilled shafts for axial loading is covered in Chapter 13 of this manual. Equations are presented for calculating nominal side and base resistances for drilled shafts embedded in various types of soil and rock. A concern that often arises pertains to the possibility that the calculated resistances could be adversely affected (reduced) by the use of slurry in drilled shaft construction. In particular, it is postulated that bentonite filter cake or the presence of polymer in the sidewalls of the borehole could

create an interface that is weaker in shear than would be the case in the absence of slurry. Earlier in this chapter, it was pointed out that many drilled shafts have been successfully installed with slurry, as evidenced by the results of numerous load tests. Also noted was that drilled shafts that were installed with bentonitic slurry have been exhumed and the interface between the concrete and the parent soil examined. In the vast majority of cases, no evidence was found of a thick, weak layer of bentonite. Furthermore, no evidence was found in the drilled shafts described of any loss of bond between the rebar and the concrete. Similar statements can be made about drilled shafts installed with polymer slurries. Nevertheless, concerns about the effects of slurry are valid because drilled shaft performance depends upon quality of construction, and proper use of slurry is an important aspect of quality.

The following paragraphs summarize research on the effects of slurry on drilled shaft behavior, with an emphasis on side resistance. The overall conclusion, supported by the available evidence, is that the design equations presented in Chapter 13 are valid for all construction methods, including slurry, *provided that the practices recommended in this manual are followed*. Most importantly, with regard to bentonite slurry, practices that limit the thickness of the filter cake to the value suggested earlier (1/8 inch), adherence to the project specifications (*e.g.*, TABLE 7-1 and TABLE 7-2), and prompt placement of concrete will result in drilled shafts with side resistances that can be predicted with confidence. Research on this topic is reviewed in the following order: (1) bentonite slurry, (2) polymer slurry, and (3) studies involving comparisons between bentonite and polymer slurries.

#### 7.5.2.1 Mineral Slurry

As discussed and illustrated in Figure 7-1, formation of a filter cake along the sidewalls is one of the mechanisms by which mineral slurry provides borehole stability in permeable materials. A thorough review on the effects of mineral slurry on side resistance was presented by Majano and O'Neill (1993), including a summary of all published load tests and other relevant research conducted up to that time. The conclusion reached by that study was that: *"An excessively thick cake (thicker than the soil asperities) degrades the interface and decreases the available perimeter shear"*. In reviewing load tests that involved direct comparison between shafts constructed under mineral slurry and other methods, the authors noted that *"Research in soils regarding the degree to which perimeter load transfer is reduced by slurry is largely contradictory"*. This statement regarding contradictions stems from studies showing that the effects of mineral slurry can range from zero or minimal (Fleming and Sliwinski, 1977; Cooke, 1979) to minor decreases on the order of ten percent (Farmer and Goldberger, 1969), to significant reductions (Wates and Knight, 1975; Cernak, 1976). Further consideration of the test conditions, however, makes it possible to identify the factors that control potential degradation of side resistance. Basically, understanding and controlling the factors that determine filter cake thickness and strength are the keys to proper use of mineral slurry. The studies that showed significant decreases in side resistance generally involved long exposure times and/or filter cake thicknesses in excess of the value recommended for current practice. In fact, some of these early studies led to the current recommended practices.

Thickness of the filter cake is a function of several factors, the most important of which are: time of exposure of the slurry to the borehole wall, properties of the slurry (dosage, unit weight), and the head difference between the slurry and the groundwater in the formation. Nash (1974) developed an analytical equation to predict filter cake thickness as a function of these variables (including time) and noted that a thickness of about 0.2 in. would be predicted at 24 hours of exposure for typical slurry and filter cake at a depth of 65 ft. Wates and Knight (1975) investigated the thickness of bentonite filter cake between concrete and sand and its effect on side resistance for diaphragm walls and drilled shafts. Laboratory tests were performed in which the filter cake thickness was found to vary with time and with the hydrostatic head of the slurry column. Small-sized piles were cast against the slurry in the laboratory and their

pullout capacities were compared to those of a pile that was cast dry and one that was cast with direct displacement of the slurry by the concrete. The authors concluded that a filter cake of significant thickness (0.3 to 0.4 inches) will develop in 24 hours and that, unless removed, reduced the side resistance to a value significantly less than if the concrete is cast directly against the natural soil. This experimental evidence and the work of Nash (1974) are some of the early studies showing the detrimental effects of allowing bentonite slurry to be left in place for 24 hours. Currently, the recommended practice is to limit to four hours the time during which mineral slurry is left unagitated in the borehole. Under some circumstances, it may not be practical to meet this time limit. In those cases, the contractor's installation plan should address the procedures to be used that will ensure proper displacement of slurry in a manner that is not detrimental to performance of the drilled shaft. Load testing provides a means to verify the suitability of the contractor's methods.

Sliwinski (1977) and Fleming and Sliwinski (1977) argue strongly that the influence of filter cake should be minimal if exposure time is not excessive and slurry properties are controlled. Sliwinski (1977) reports that the rising column of concrete will displace the slurry and much of the cake because of the considerable difference in unit weight and shear strength of the fluid concrete and mineral slurry. Although the portion of the slurry that penetrates the soil cannot be displaced, Sliwinski states that field and laboratory tests seem to indicate that the influence of some mineral slurry in the parent soil has an insignificant influence on load transfer. The conclusion is based on the assumptions that the properties of the slurry are within reasonable limits and that the concrete placement is done within a reasonably short time after the excavation is completed. In support of this opinion, Fleming and Sliwinski (1977) reported on 49 field tests from several different countries. They report that the test results suggest that the development of shaft friction had not been "impaired or inhibited" by the presence of mineral slurry. They point out that the drilled shafts that were tested and analyzed had "in all probability been constructed and tested without any inordinately long delay between boring and concrete placing."

The following case reported by O'Neill and Hassan (1994) demonstrates dramatically that mineral drilling slurry can either produce a devastating loss of side resistance or a completely satisfactory value of side resistance, depending on how the slurry is mixed and controlled, and the importance of good slurry specifications and inspection of the slurry drilling process. Two drilled shafts, 3 ft in diameter, were constructed side by side to a depth of about 35 ft in a medium dense, saturated, silty sand under bentonite drilling slurry. For the first drilled shaft, the Marsh funnel viscosity was 155 sec./quart, the yield point was 30 Pa, the time of exposure of the slurry to the borehole without slurry agitation prior to concrete placement was 72 hours, and the resulting measured filter cake thickness before concreting was 0.4 in. In the second shaft, the Marsh funnel viscosity was 40 sec./quart, the yield point was 9.6 Pa, the time of exposure was 2 hours, and the mudcake thickness was less than 0.04 in. The first drilled shaft developed an ultimate side resistance of 45 kips, or about 136 psf average unit side resistance, while the second drilled shaft developed an ultimate side resistance of about 606 kips, or about 1,800 psf average unit side resistance.

Taken together, the studies summarized above point to the following conclusions:

Potentially adverse effects of mineral slurry on drilled shaft side resistance can be avoided by maintaining the properties of the slurry within tolerable limits and by placement of concrete within a maximum of a few hours after the excavation is completed. The drilling and concreting processes should proceed in a continuous fashion and the soil or rock should not be exposed to the mineral slurry for an excessive period of time. In general, if mineral slurry remains in a borehole unagitated for more than about four hours, its gel or shear strength becomes too high to permit full flushing by the concrete. Furthermore, the filter cake that builds up on the borehole walls can become hard, and a layer of very viscous gel can accumulate over the filter cake, possibly reducing the side resistance that can be developed in the

completed drilled shaft. Good practice, therefore, includes specifying that the contractor agitate mineral slurry that will be held in the borehole for more than four hours between the completion of drilling and the commencement of concrete placement. Otherwise, the contractor should re-cut the sides of the borehole, possibly using a side cutter affixed to an auger or drilling bucket, to a diameter of about 2 inches larger than the diameter of the original borehole and then re-clean the base before placing concrete. Considering this potential problem, contractors should not be permitted to place the rebar cage in the slurry until just prior to concreting.

The preceding discussion relates to the production of filter cake in permeable soils and rocks. Since filtration into the formation being drilled is the principal mechanism of filter cake buildup in mineral slurries, filter cake tends not to develop in impermeable geomaterials such as clays, and concern about loss of skin friction due to filter cake buildup is lessened. This hypothesis is supported by load tests, for example, see Cooke (1979).

### 7.5.2.2 Polymer Slurry

O'Neill and Hassan (1994) report on load tests performed by Caltrans on five drilled shafts in sandy silt to silty sand in the Los Angeles area. These shafts were all 2 ft in diameter and about 33 ft deep. Four were constructed under polymer slurry -- two with emulsified PAM and two with dry vinyl-extended PAM. All of the shafts were loaded in compression. In all four cases the average unit side resistances were consistent with values predicted using the design methods recommended by O'Neill and Reese (1999). While no filter cake builds up with polymer slurry, the slurry itself has a "slimy" texture, and it may appear that such slurry could lubricate the interface between the concrete and soil. However, the polymer breaks down at values of pH greater than about 11.7 when exposed to lime in the concrete, with the resulting chemical products being water and carbon dioxide. Since fluid concrete generally has a pH greater than 12, it has been hypothesized that the exposure of concrete to polymer slurry destroys the polymer and appears to leave the concrete in contact with the soil at the surface of the borehole. The small amount of residual water and carbon dioxide remaining near the interface do not appear to cause any problems, although long-term test data are not available. A fifth drilled shaft, constructed at the same site with only water as a drilling fluid, developed slightly higher unit side resistance than the shafts constructed with polymer drilling slurries. This single test result suggests the slurry itself appeared to affect some reduction in side resistance from the value that would have been achieved had slurry not been used.

Majano et al. (1994) observed that side resistance increased slightly with time of exposure of polymer slurry to the soil prior to concrete placement in model drilled shafts constructed with two polymer slurries, whereas side resistance decreased with time of exposure when mineral slurries were used. Ata and O'Neill (1997) report values of unit side resistance in excess of those that are predicted with the design equations given by O'Neill and Reese (1999) constructed with high-molecular-weight PAM slurry in stiff clay, stiff very silty clay, and medium dense sand.

While development of side resistance does not appear to be a problem with polymer drilling slurries, there is anecdotal evidence that difficulties have been experienced on some transportation projects with polymer slurries that have not maintained borehole stability, particularly for deep, large-diameter boreholes in sand and gravel. Whether these problems were caused by physical properties of the particular polymer slurries used on these projects, or whether they are caused by inadequate construction practices, is unclear. It is clear that the slurry should be mixed and conditioned properly and its viscosity and hardness closely controlled throughout the drilling process (for hardness, indirectly by continually monitoring pH).



It is also clear that contractors must be diligent in introducing the slurry at the time the piezometric surface is reached, not at the time caving problems are experienced. Once caving starts at any level, it is very difficult for any drilling fluid, especially a low-density polymer slurry, to keep the borehole from continuing to ravel or slough, even if ideal practices are followed for the remainder of borehole excavation. The contractor must also be careful to maintain the slurry head well above the piezometric level at all times and use vented drilling tools operated at a relatively slow rate. If sloughing starts under a head of slurry, the contractor may be forced to re-cut the hole back to a cylindrical shape to arrest the sloughing or to backfill and re-drill the hole.

### 7.5.2.3 Comparisons of Bentonite and Polymer Slurries

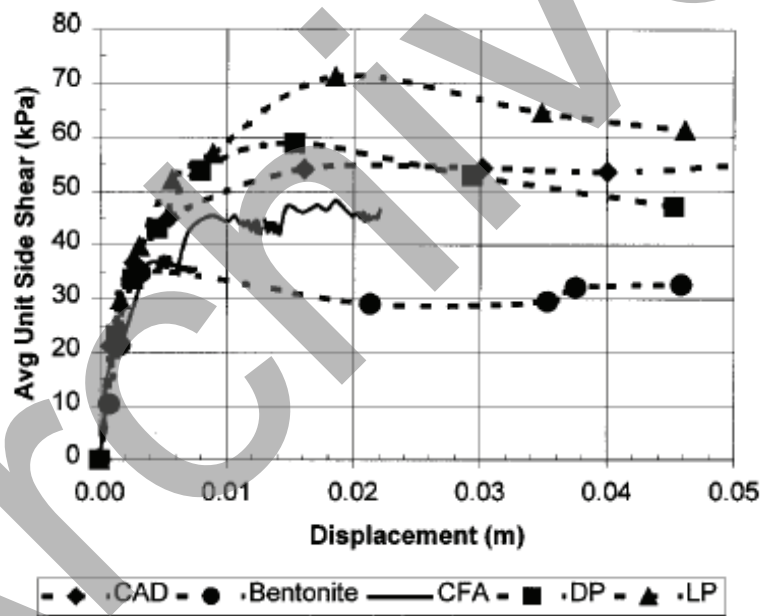
Several comparative studies have been published in which drilled shafts constructed side by side under both bentonite and polymer slurries were load tested. Meyers (1996) describes a case where two drilled shafts, 2.5 ft in diameter and 45 ft deep, were constructed and tested in saturated sand/gravel/cobble alluvium to develop design criteria for a foundation for a bridge project in New Mexico. One shaft was constructed with controlled bentonite slurry, and the other was constructed with a high-molecular-weight proprietary dry polymer. Both boreholes were calipered to verify that they had equivalent diameters. While both drilled shafts developed higher side resistances than would be predicted by the methods given by O'Neill and Reese (1999), the drilled shaft constructed with the polymer slurry developed higher side resistance than the shaft constructed with bentonite slurry.

Camp et al. (2002) describe load tests on twelve instrumented drilled shafts in Cooper marl, a stiff calcareous clay, in the Charleston, S.C. area. Test shafts were either 6 ft or 8 ft diameter and either 100 ft or 150 ft deep and were constructed in the dry, with bentonite slurry, with polymer slurry, and using fresh water as a drilling fluid. The authors report that measured average unit side resistances were all within 10% of each other and conclude that no discernible differences could be attributed to the construction method. The authors also note that the Cooper marl is a low-permeability material, and that bentonite filter cake would not be expected to form under these conditions.

Brown (2002) describes a load testing program involving ten drilled shafts installed in Piedmont residual soils in Spring Villa, AL. The soil profile is described as micaceous sandy clayey silt, classified as ML-SM, with sand seams. All test shafts were 3-ft diameter, 35-ft deep. Two shafts were constructed under bentonite slurry; four under polymer slurry (2 dry, 2 liquid), and four with full-depth casing advanced ahead of the excavation. Figure 7-14 shows average unit side resistance versus displacement curves (averaged for each construction method). [Also shown is the result for a single continuous flight auger, or CFA, pile]. The most noteworthy result shown in Figure 7-14 is that the bentonite shafts exhibited significantly lower side resistance than shafts constructed by the other techniques. Subsequent excavation of the test shafts revealed an easily identifiable seam of bentonite along the sidewalls of the shafts constructed under bentonite slurry. No visible film was observed along the walls of the shafts constructed under polymer slurries. Brown concludes that the lower observed side resistances in the fine-grained silty soils at this site are a result of filter cake formation, even though exposure times were limited. Marsh funnel values for bentonite were 52 seconds/quart, slightly above the range recommended in TABLE 7-1.

Frizzi et al. (2004) report the results of load tests on three 6-ft diameter, 120-ft long drilled shafts installed in alternating layers of soft rock (sandstone and limestone) and sand in Miami, FL. Two of the test shafts were installed using polymer slurry and one shaft was constructed using bentonite slurry. Load testing was by Osterberg load cells embedded near the bottom of the test shafts and load transfer was inferred from strain gage readings on sister bars (see Chapter 17 for a full description of this test method). Figure

7-15 shows the mobilized unit side resistance versus depth for all three shafts, over the depth interval 70 to 120 ft, which corresponds to rock sockets in the Fort Thompson Formation. For the polymer shafts (PS1 and PS2), unit side resistance varies between 5 and 20 ksf, while for the bentonite shaft unit side resistance varies between 4 and 23 ksf. The authors state that unit side resistance along the upper one-half of the bentonite shaft is approximately 25% to 50% lower than in the polymer shafts, but approximately similar in the lower one-half of the socket. However, as can be observed in the figure, mobilized unit side resistance varied significantly between the two polymer slurry shafts (PS1 and PS2) and, over the depth interval from approximately 103 – 106 ft, the bentonite shaft exhibits much higher side resistance than the slurry shafts, making it difficult to draw a strong conclusion regarding the influence of the various polymer slurries. The authors report that sampling of the sidewalls during excavation identified a 0.3-inch thick layer of soft bentonite on the perimeter of the borehole plus a 0.04-inch thick filter cake penetrating the soft rock in the upper rock strata, but that no well-defined bentonite accumulation or filter cake could be discerned in the lower rock strata. It is not stated at what depths these sidewall samples were obtained, but reduced side resistance in the upper portion of the socket would be consistent with higher filter cake thickness. It is also possible that side resistance of the test shafts was influenced by factors other than slurry type, for example, variable ground conditions. As a footnote, it is interesting that the bentonite shaft exhibited an overall higher capacity, derived mainly from a much higher base resistance than either of the polymer slurry shafts.



CAD: cased-ahead method; CFA: auger-cast pile; DP: dry polymer; LP: liquid polymer

Figure 7-14 Average Load Transfer in Side Shear for Different Construction Methods (Brown, 2002)

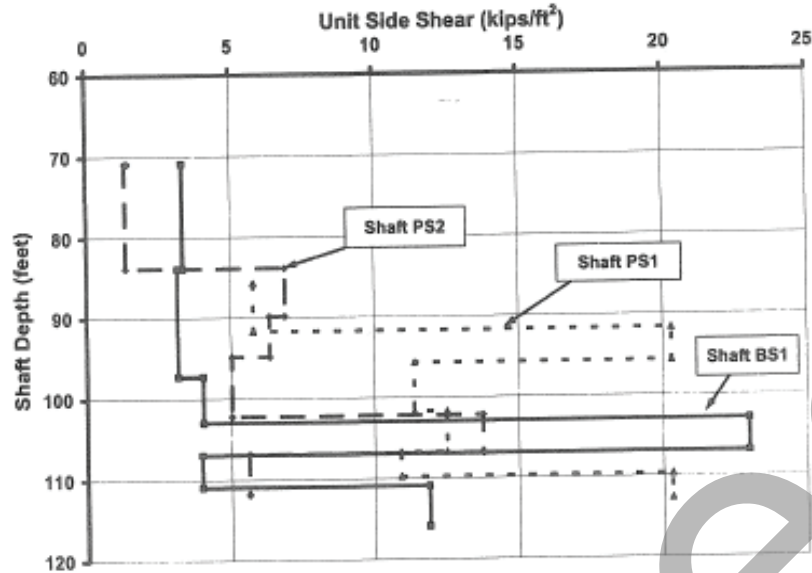


Figure 7-15 Mobilized Unit Side Resistance in Lower Fort Thompson Formation Rock Sockets (Frizzi et al., 2004)

Laboratory and field evidence suggest that polymer slurries may improve the side resistance of drilled shafts in rock that may otherwise degrade in the presence of water. Brown (2008) reports the results of slake durability tests on shale as part of a load testing program for the Paseo River Bridge in Kansas City. Slake Durability Index ( $I_D$ ) is a measure of a material's resistance to degradation when subjected to a series of wet-dry cycles with mechanical agitation by tumbling in a drum. A higher value of  $I_D$  indicates greater resistance to degradation in the presence of water (slaking). The index was measured on identical samples, but one using Missouri River water and the other using a polymer slurry. For the sample tested in water,  $I_D = 72$ , while for polymer slurry  $I_D = 98$ . Both of these results exceed the value that would suggest significant degradation ( $I_D \leq 60$ ) but these data suggest that the polymer has a beneficial effect on the shale slake durability. Based on the laboratory tests, polymer slurry was recommended as the drilling fluid for construction of rock sockets in the shale.

Conditions at the base of a drilled shaft constructed under slurry must also be considered carefully. If excessive soil or rock cuttings or flocculated or agglomerated slurry accumulate on the base of a drilled shaft constructed by the wet method, some of this loose material may be pushed to the side by the introduction of concrete, rather than being lifted up by the concrete. This action will result in a "bullet-shaped" base that is bearing against the soil or rock only over part of the cross-section of the drilled shaft, adversely affecting base resistance. Cleaning of the base of the drilled shaft just prior to placing the cage and concrete and verification that the base is clean just before concreting, are therefore very important parts of the construction and inspection processes.

### 7.5.3 Bond with Reinforcing Steel

Fleming and Sliwinski (1977) report that the general opinion is that there is no significant reduction of bond between concrete and the reinforcing steel in drilled shafts constructed under bentonitic slurry. They report that the Federation of Piling Specialists (1975) recommends the use of the maximum allowable bond stress values for round, nondeformed bars in bentonitic slurry. For deformed bars the FPS recommend an increase in bond of not more than 10 per cent of the value specified for plain bars.

Butler (1973) exhumed full-sized drilled shafts constructed under light bentonitic drilling slurry and conducted pullout tests on the rebar. He concluded that the bond between the concrete and No. 8 deformed longitudinal rebars was not degraded.

Most information on bond between concrete and rebar when the drilled shaft is concreted under a polymer slurry has been developed by research commissioned by the polymer suppliers, and documentation can be obtained from them. One laboratory study was made of the simulated placement of a standard mix of concrete (Type II Portland cement and maximum coarse aggregate size of ½ inch) around No. 5 deformed bars under a slurry made from an anionic, high-molecular-weight PAM mixed to the manufacturer's specifications. Test results suggested that the bond strength develops more slowly than when drilled shafts are concreted under light bentonite slurry. At 28 days, however, the bond strength obtained when the rebar had been exposed to the polymer slurry at a dosage of 2.5 g (solid powder) / L (mixing water) was slightly greater than the bond strength obtained by similar simulated concreting under a light bentonite slurry [50 g (solid powder) / L (mixing water)] (Maxim Technologies, Inc. 1996).

The current state of knowledge on this topic suggests that the use of mineral and polymer slurries for drilled shaft construction does not reduce the bond resistance between concrete and reinforcing bars. There is currently no reason to account for the use of drilling fluids when considering development length of rebar in drilled shafts.

#### **7.5.4 Summary of Major Handling Considerations**

This chapter includes a large amount of information on various types of drilling fluids currently used for drilled shaft construction. Some of the most important construction-related issues to keep in mind for the two major categories of drilling fluids (mineral slurry and polymer slurries) are summarized in the following. All of these issues are discussed in more detail in preceding sections of this chapter and are merely listed here for convenience.

For mineral slurries the major areas of risk are associated with (1) improper mixing and handling that can lead to instability of the borehole, (2) excessive filter cake thickness that reduces side resistance, (3) inadequate cleanout at the base of the shaft, and (4) improper concrete placement techniques that fail to completely displace the slurry. The following measures are therefore critical:

- **Mixing and handling** Trial mix designs should be established on the basis of testing as described in Sections 7.3.1 and 7.4.3.2. The mixing water must be screened for salt content, pH, hardness, and chloride content to avoid flocculation. Provide high-shear mixing and adequate time for hydration of bentonite, preferably 24 hours prior to its introduction into the borehole. Properties of mineral slurries during construction should be monitored and maintained within the limits specified in TABLE 7-1 or in accordance with owner-defined specifications.
- **Control of Filter Cake Thickness** A filter cake thickness greater than approximately 1/8 inch on the sidewalls of the borehole prevents complete displacement of bentonite by the fluid concrete and adversely affects side resistance. To avoid excessive filter cake thickness place concrete as promptly as possible, preferably within four hours after completion of the excavation. Where this is not possible, the measures outlined in Section 7.5.2.1 are recommended, such as re-cutting the sidewalls of the borehole, additional cleaning of the slurry, etc. For very large shafts requiring massive volumes of concrete, it may not be possible to avoid formation of excessive filter cake and side resistance may have to be reduced. Load testing provides a means to quantify the reduced side resistance.

- Adequate Cleaning and Processing The amount of sediment suspended by a mineral slurry determines its ability to be displaced by fluid concrete. Procedures and equipment used to circulate and clean the slurry must be adequate to maintain the viscosity and sand content within the limits specified in TABLE 7-1. Cleaning of slurry at the base of the drilled shaft is critical to avoid trapping of slurry and sediment beneath the tip of the shaft, a condition that may prevent mobilization of base resistance without excessive settlement. This issue is addressed further in Section 9.3.3.3.
- Proper Concrete Placement Proper procedures for placement of concrete under slurry are covered in Section 9.3.3. The most important considerations are that the concrete have good workability for the duration of the placement operations and that the bottom of the concrete delivery tube be maintained below the rising surface of fresh concrete. A minimum depth of embedment of 10 ft is recommended.

For drilling fluids made from polymers the primary risks are associated with (1) incompatibility with the ground conditions, (2) damage to the polymer chains by improper mixing equipment, (3) hole instability due to insufficient pressure head, and (4) inadequate time for sedimentation and cleaning. The following measures are most important.

- Consultation with the Supplier Polymers used for drilling fluids encompass a wide range of products having different chemical compositions and additives. It is important to match the product with the ground conditions and this requires the expertise of the polymer supplier in order to select appropriate product and additives based on soil type and water chemistry.
- Mixing and Handling Any type of mechanical action that disrupts the chain structure of polymers diminishes the effectiveness of the slurry. Use of in-line mixers, diaphragm pumps, and splash plates are effective measures to avoid damage. High-shear mixing, mechanical mixing with blades, and cyclones should be avoided. Equipment for mixing and cleaning mineral slurries is not appropriate for polymer slurries. Polymer slurry would not be considered suitable with full-circulation drilling in most cases.
- Adequate Pressure Head Good practice includes introduction of the slurry before excavating into unstable strata and maintenance of sufficient head of slurry. The elevation head difference between slurry and piezometric elevation should be a minimum of 6 ft and preferably 10 ft. This measure is important when using bentonite slurry also, but it is especially critical with polymer slurries because of their lower densities.
- Adequate Time for Sedimentation Polymer slurries do not suspend soil particles. It is important to allow sufficient time for sediment to settle to the bottom of the slurry column, then to clean the slurry of sediment using a cleanout bucket or airlift just prior to placement of concrete. The time required for sedimentation can range from 30 minutes to 2 hours, depending on the size of the shaft, amount of sediment, and type of polymer. For polymer slurry with excess silt, complete replacement with clean slurry should be considered.

In addition, the concrete placement methods described above for bentonite slurry are applicable to polymer slurries.

## 7.6 SELECTION OF DRILLING FLUIDS

Selecting the type of drilling fluid to use on a particular project is often a major consideration for a contractor in the bid preparation. Some of the most significant factors taken into account are discussed as follows.

- Ground conditions Both bentonite and polymer slurries are applicable to a wide range of soil conditions. Regardless of the product, the contractor must be confident that the drilling fluid will provide a stable borehole without caving and will allow for proper placement of concrete, *for the particular subsurface conditions associated with each job*. This must be achieved while also meeting the specifications provided by the owner. In Chapter 2 it is emphasized that a thorough site characterization program and report are needed not just for drilled shaft design, but also for construction. Selection and mix design of a suitable drilling fluid are prime examples of construction-related issues that requires accurate subsurface information, especially on soil classification, grain size distribution (for example, fines content), and groundwater conditions.
- Equipment availability The equipment required for mixing, storage, circulation, cleaning, and testing of drilling fluid can represent a major investment and/or rental cost to drilled shaft contractors. As described in Section 7.4, much of the equipment used to handle bentonite slurry is different than the equipment used to handle polymer slurry. Some contractors have invested in one or the other and therefore will plan to use the type of drilling fluid governed by their equipment capabilities.
- Experience The experience of a contractor will always affect the means and methods they select to apply on a particular job. Some contractors have broad experience with the use of different slurry types while others have more narrow experience and will prefer to use the type of slurry with which they are experienced. Local experience may also suggest that particular drilling fluid products be used. For example, some regions of the U.S. have a long history of successful use of bentonite slurry for drilled shaft construction and the local market has evolved such that contractors in that area are experienced primarily with bentonite slurry construction.
- Specifications Specifications imposed by the owner will be taken into account by a contractor when considering the costs of meeting the requirements for material properties, costs of testing, the need for additives or special equipment, or any other costs associated with meeting specifications. Also, some transportation agencies have specifications that impose strict limitations on the types of drilling fluid products allowed. Some states prohibit the use of mineral slurries and allow only polymer products which have been screened and included on a list of approved products. Other states have specifications that prohibit the use of polymer slurry.
- Environmental factors The possibility of contamination to the environment is a consideration by contractors and owners in evaluating the use and disposal of drilling fluids.
- Level and quality of technical support provided by the material supplier On some projects, especially large projects, very close cooperation is required between the contractor and the material provider in order to select the appropriate product, evaluate mix designs, install and monitor technique shafts, and work through problems and issues as they arise during construction. The availability of the supplier's representatives and the quality of service they provide to the contractor are important considerations in selecting a particular product. In effect, the contractor is not simply purchasing a material; rather they are investing in the supplier's expertise and experience.
- Disposal The issue of disposal affects the cost and the operations of the contractor. It is noted several times in this chapter that disposal of mineral slurries can be challenging and costly,

depending upon local environmental regulations, distance from the project site to disposal facilities, and the amount of slurry to be disposed. Less cumbersome (and less costly) disposal measures are often possible with polymer slurries, however, disposal is project-specific and must be evaluated on a case-by-case basis.

- **Cost** In addition to the basic costs of the mineral or polymer materials and their transportation, all of the items listed above will affect the total cost to the contractor for construction with the use of drilling fluids. The total cost is the deciding factor in competitive bidding for drilled shaft construction.

## 7.7 EXAMPLES OF PROBLEMS AND SOLUTIONS WITH CONSTRUCTION UNDER DRILLING FLUIDS

Several scenarios are discussed in this section in which problems can develop with construction under drilling fluids. They demonstrate that, when installing a drilled shaft with drilling fluids, both the contractor and the inspector need to be continually trying to visualize what is happening in the ground.

- **Problem 1:** Figure 7-16 illustrates one of the most common cases where difficulties arise in slurry construction. The drilling fluid can be either a mineral slurry or a polymer slurry. An excavation is made through overburden soil into disintegrated rock using fluid. Figure 7-16a shows the completed excavation with the fluid in place. The slurry is carrying more sand than it can hold in suspension. However, it is not sampled properly and consequently is not cleaned prior to starting the concrete placement with a tremie. Sand settles to the top of the concrete column as the pour progresses, as shown in Figure 7-16b. Frictional resistance between the borehole wall and granular material is such that the flowing concrete breaks through and folds the layer of granular material into the concrete, creating a defect, as shown in Figure 7-16c. A cubic yard or more of granular material can settle to the top of the concrete column in a large-sized drilled shaft if the slurry is poorly cleaned.

**Solution:** Measure the depth of the excavation two or more times after drilling ceases to verify that sediment is not settling out and that the hole is as deep as indicated by the penetration of the drilling tools. Furthermore, the drilling fluid should be sampled carefully from the bottom of the hole and tested to ensure that specifications are met. A comparison of the actual volume of concrete that is placed with the expected volume, as pre-determined from the use of calipers or from the planned shaft dimensions, can readily reveal if a considerable amount of sediment has been left in the concrete, and the plotting of a concreting curve (Chapter 9) can reveal the general location of the trapped sediment.

- **Problem 2:** Figure 7-17a shows that an excavation has been made to a certain depth by use of mineral slurry and that a casing has been placed in the slurry with its bottom being sealed in an impermeable formation. The slurry has been pumped from the casing, and the excavation has been carried to its full depth. Some slurry is left in the overbreak (void) zone between the casing and the side of the borehole. Figure 7-17b shows that the concrete has been placed and that a layer of liquid slurry has been left at the interface of the concrete and the natural soil. The slurry is so thick that a considerable mound of thickened slurry and solids has piled up on the ground surface where it was displaced by the concrete, which in turn has impeded the complete flushing of all of the liquid slurry that was initially in the overbreak zone. The problem was caused because the slurry was not sampled and tested before the casing was placed. The mineral slurry was much too thick (too viscous), contained inclusions of clay and granular material (had too high a density value), and it could not be displaced completely by the concrete.

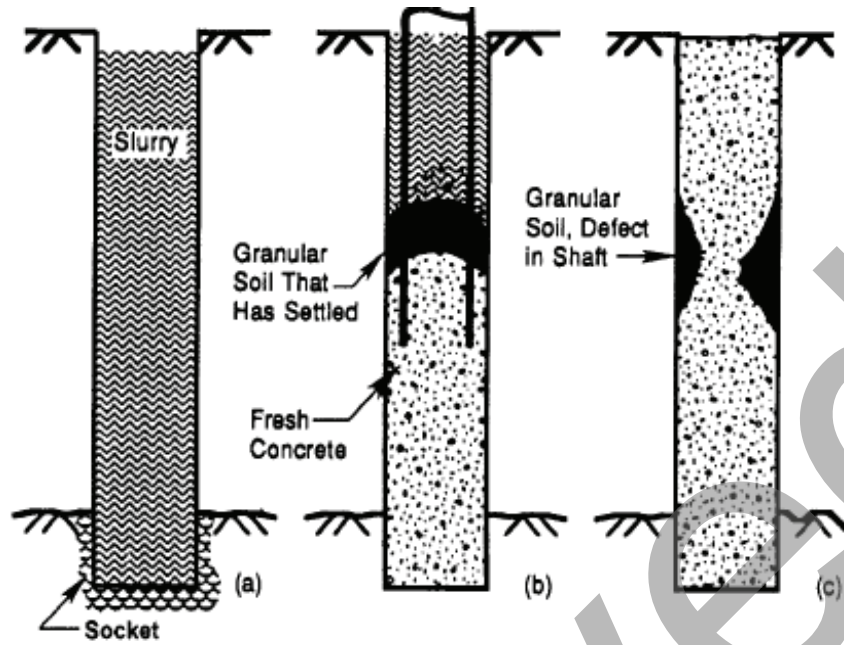


Figure 7-16 Placing Concrete through Heavily-Contaminated Slurry

**Solution:** Be sure that the slurry meets the proper specifications before the casing is placed, and complete the concrete pour within a reasonable time after the casing is placed. Coordinate concrete placement and extraction of the temporary casing to more effectively flush the slurry from the sidewalls of the borehole.

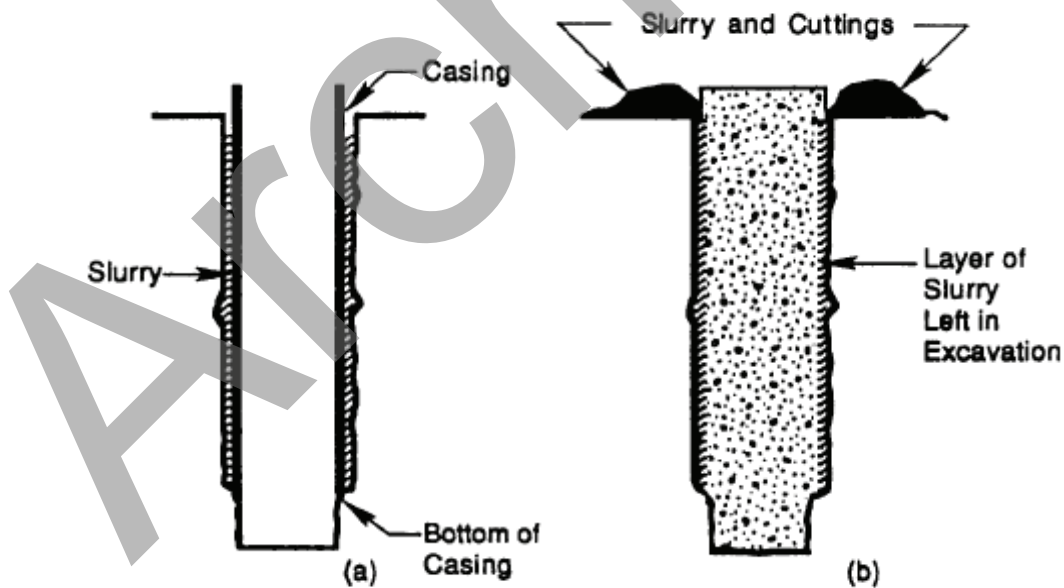


Figure 7-17 Placing Casing into Mineral Slurry with Excessive Solids Content



- Problem 3:** Figure 7-18a shows the case where construction has been carried out properly with the casing method, with the casing being sealed at its base in an impermeable formation. Figure 7-18b shows that the casing has been pulled with an insufficient amount of concrete in the casing so that the hydrostatic pressure in the drilling fluid was greater than that in the concrete, with the result that the drilling fluid invaded the concrete and produced a "neck" in the drilled shaft.

**Solution:** Pull the casing only after it is filled with concrete with good flow characteristics. Then, the hydrostatic pressure in the concrete will always be greater than that in the drilling fluid in the overbreak zone because the unit weight of the concrete is greater than that of the drilling fluid.

- Problem 4:** Figure 7-19 illustrates a casing that is driven by a vibratory driver into a sand stratum, and it is intended that the casing penetrate through the stratum of caving soil into an impermeable material. However, the casing is stopped short of the impermeable material into which it could seal. Drilling fluid is used to extend the borehole below the casing. As the drilling progresses, the sand collapses behind the casing for a considerable distance, as shown in Figure 7-19a. When the concrete is placed, even though the casing is filled with concrete with good flow characteristics, some of the drilling fluid outside and above the bottom of the casing becomes trapped and is not ejected. The result is shown in Figure 7-19b; some of the drilling fluid has fallen into the concrete, and a weak zone is created in the completed drilled shaft.

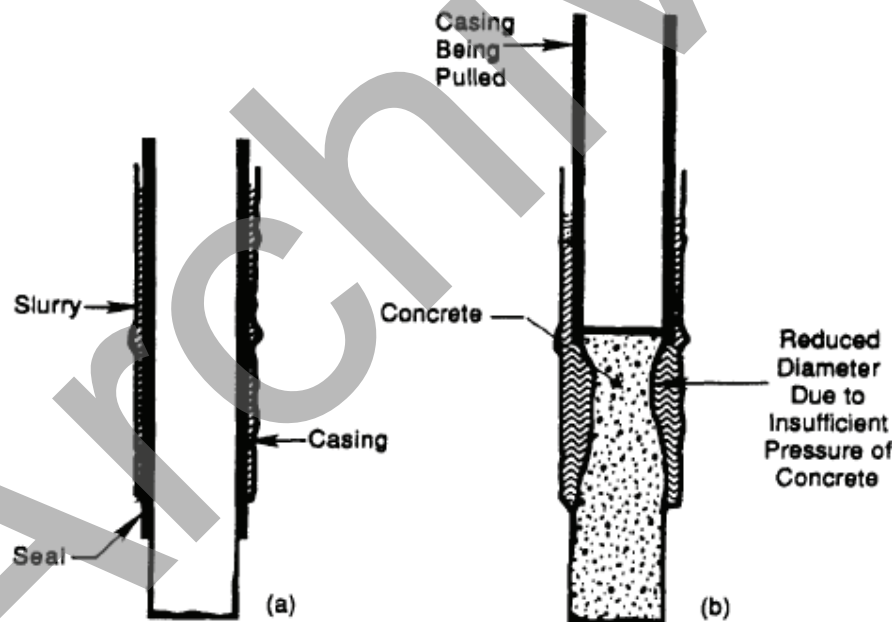


Figure 7-18 Pulling Casing with Insufficient Head of Concrete

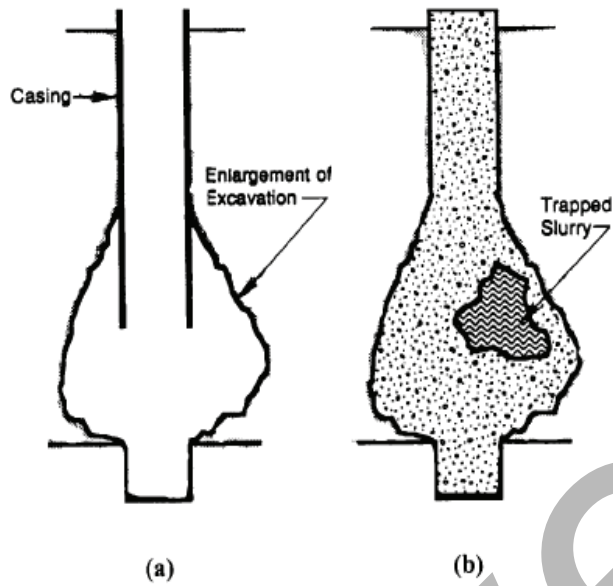


Figure 7-19 Placing Concrete where Casing was Improperly Sealed

**Solution:** Be sure that the casing penetrates the caving layer fully, if at all possible. The fluid pressure in the slurry column in any case should be kept at an appropriate value so that no caving occurs. It is of utmost importance that the level of the drilling fluid be kept well above that of the natural water table (piezometric level) in order to prevent any inward flow and a consequent loosening of the supporting soil. Additionally, the hole below the casing can be calipered and, if the enlarged excavation is discovered, appropriate measures taken.

- **Problem 5:** A large-diameter drilled shaft is being advanced into a stratum of sand and gravel under a polymer slurry and, despite using an effective tool and bringing up considerable cuttings on each pass, the borehole is not being deepened. This condition is likely being caused by sloughing from the walls of the borehole, indicating that the slurry is not acting effectively in maintaining stability.

**Solution:** Verify that the slurry properties, particularly the viscosity and the pH, are as specified. If not, modify the properties of the polymer slurry before proceeding. Make sure that the head of slurry is kept above the piezometric surface at all times and is not even momentarily allowed to drop below that level. This may require placing a surface casing to use as a standpipe to bring the slurry surface above ground level if the piezometric surface is near the ground surface. It may be necessary to enlarge the diameter of the borehole to the full depth of the present excavation to arrest the sloughing process even though the slurry properties and construction procedures are now correct. Once overhang zones start to appear due to borehole sloughing, sloughing may continue even with correct techniques until the hole is made cylindrical once again. Alternatively, the excavation can be backfilled to above the zone of caving and the hole redrilled. Casing could be used instead of slurry, if the contractor is prepared for this option.

The descriptions of potential problems given above may give the incorrect impression that construction with drilling fluids is inherently problematic. While occasional difficulties have occurred, the collective experience of the drilled shaft industry suggests that the overall performance of slurry-constructed drilled shafts has generally been excellent. For those shafts that are not satisfactory, steps in the construction

process can almost always be identified that were not in accordance with good practice, either due to contractor errors or to factors that were beyond the contractor's immediate control, such as a delay in the delivery of concrete from a ready mix plant while a concrete pour was underway. If care is taken in the construction process, a finished product of high quality can, and should, be expected.

## 7.8 SUMMARY

Drilling fluids play a critical role in the construction of drilled shaft foundations. Their primary functions are to maintain the stability of the borehole and to facilitate the placement of concrete by displacement of the drilling fluid. This chapter describes the issues that must be addressed in order for drilling fluids to be used successfully. Drilling fluids for drilled shafts are made from two types of materials: bentonite or related clay minerals, and synthetic polymers. Each has different material properties and they must be handled differently in order to perform properly in drilled shaft construction. Engineers and contractors involved in drilled shaft construction with drilling fluids must recognize and understand the unique characteristics of each. One of the primary differences is that bentonite slurries will suspend silt and sand particles while polymer slurries generally do not.

Experience and research have demonstrated that drilling fluids made from both types of materials, bentonite and polymers, can provide a highly effective means for constructing quality drilled shafts when handled properly. Factors that lead to successful performance, and those that may lead to unsatisfactory performance, are identified in this chapter.

Archived

This page is intentional left blank.

## **CHAPTER 8**

### **REBAR CAGES**

#### **8.1 INTRODUCTION**

The design of the reinforcing, or "rebar," cage for a drilled shaft is a necessary step in the engineering process. Rebar cages will be considered from two perspectives in this manual: (1) geometry of the steel necessary to resist stresses that develop because of loads applied to the drilled shaft, which is addressed in Chapter 16, and (2) the characteristics of the cage from the perspective of constructability, which is addressed in this chapter.

A rebar cage for a drilled shaft is made up of longitudinal bars that are normally distributed with equal spacing around the outside of a cylinder. Transverse reinforcing is placed around and attached to the longitudinal bars, with the longitudinal and transverse steel being held together with ties, clamps, or, in special cases, with welds. Other components of a rebar cage that may be used are hoops for sizing, guides for centering the cage in the borehole and the tremie inside the cage, and stiffeners and pickup devices to aid in lifting the cage. For long cages and cages with large diameters, temporary or permanent strengthening elements should be provided to prevent permanent distortion of the cage as a result of stresses due to lifting and placing.

The required amount of reinforcing steel to be placed in a drilled shaft must satisfy structural requirements. The axial load, lateral load, and moment (taking into account the eccentricities due to accidental batter and tolerance in location) can be applied to the shaft head, and the combined stresses can be computed. The placement of reinforcing steel is made in consideration of the stresses that will exist, using appropriate load factors in the computations. However, when considering how the steel cage resulting from the structural computations is to be assembled and handled during construction, a number of important empirical rules discussed in this chapter should be followed.

The assumption is made that the rebar cage is always placed in the excavation, and the concrete is then placed, during which it flows around the cage. Short rebar cages may be pushed or vibrated into fresh concrete, but such a procedure is unusual.

#### **8.2 PROPERTIES OF STEEL**

The American Society for Testing and Materials (ASTM) provides specifications for several steels that can be used for reinforcing drilled shafts. These specifications are presented in the Annual Book of ASTM Standards and are conveniently collected in Publication SP-71 of the American Concrete Institute (ACI, 1996). Most of the ASTM steels also have a designation from the American Association of State Highway and Transportation Officials (AASHTO). The properties of steel that may be employed for building rebar cages for drilled shafts are shown in Table 8-1. The steel that is usually available is AASHTO M 31 (ASTM A 615) in either Grade 40 [40 ksi yield strength] or Grade 60 [60 ksi yield strength]. The specifications in the table do not address the welding of the M 31 or M 42 steels because these bars are not to be welded in normal practice. Where the welding of the rebar cage is desirable, a weldable steel, ASTM A 706, can be specified, but availability is often limited.

Galvanized or epoxy-coated steel is also available for longitudinal and transverse reinforcement for those cases where there is increased risk of corrosion. Epoxy-coated steel is sometimes specified for drilled

shaft rebar cages in marine environments, where the chlorides content of the ground and/or surface water is high. Nicks and blemishes in the coating that may occur during lifting and placement of drilled shaft reinforcement into the excavation can become points for accelerated corrosion; accordingly, specification of coated bars can present unusual challenges for construction of drilled shafts. Alternatively, the rebar may be used without epoxy, and a dense concrete of low permeability may be specified, as discussed in Chapter 9. Increased concrete cover requirements can also be used to increase corrosion protection.

The designations of deformed bars, their weights per unit length, cross-sectional areas, and perimeters are given in Table 8-2. The values shown in the table are equivalent to those of a plain bar with the same weight per unit length as the deformed bar. Table 8-1 shows the maximum size of bar that is available for the designations of steel. Plain bars are not recommended.

The modulus of elasticity of steel is usually taken as 29,000,000 psi. For design purposes the stress-strain curve for steel is usually assumed to be elastic-plastic, with the knee at the yield strength (Ferguson, 1981).

**TABLE 8-1 PROPERTIES OF REINFORCING STEEL FOR CONCRETE REINFORCEMENT**

ASTM Designation	AASHTO No.	Description	Yield Strength ksi	Weldable	Max. Bar Size
A 615	M 31	Deformed and plain billet-steel bars	40 60	No	No. 18
A 616	M 42	Deformed and plain rail-steel bars	50 60	No	No. 11
A 706	-	Deformed low-alloy steel bars	60	Yes	No. 18

**TABLE 8-2 WEIGHTS AND DIMENSIONS OF DEFORMED BARS (CUSTOMARY)**

Bar No.	Weight lb/ft	Diameter in.	Cross-Sectional Area in. <sup>2</sup>	Perimeter in.
3	0.376	0.375	0.11	1.178
4	0.668	0.500	0.20	1.571
5	1.043	0.625	0.31	1.963
6	1.502	0.750	0.44	2.356
7	2.044	0.875	0.60	2.749
8	2.670	1.000	0.79	3.142
9	3.400	1.128	1.00	3.544
10	4.303	1.270	1.27	3.990
11	5.313	1.410	1.56	4.430
14	7.650	1.693	2.25	5.320
18	13.600	2.257	4.00	7.090

On rare occasions, it may be advantageous to use high strength reinforcement, such as Grade 75. Figure 8-1 is a photo of the GR75 threaded bars that were used in the fast-track reconstruction of the collapsed I-35W bridge in Minneapolis. Threaded couplers were used to make splice connections. Even higher strength bars are available, but the current AASHTO design code does not include provisions for reinforcement with yield strengths higher than 75 ksi.



Figure 8-1 GR75 Reinforcement Cage Being Assembled, Showing Threaded Couplers

### 8.3 LONGITUDINAL REINFORCING

The principal role of the longitudinal reinforcing steel in drilled shafts for transportation structures is to resist stresses due to bending and tension. If the computed bending and tensile stresses are negligible, there may seem to be no need at all for longitudinal steel except as required by specifications. However, construction tolerances will allow nominally concentric axial loads to be applied with some amount of eccentricity, unanticipated lateral loads may occur (such as those caused by long-term lateral translation of soil), and the top portion of any drilled shaft will need to act as a short column if there is any axial load. Therefore, it is good practice to provide at least some amount of longitudinal steel reinforcing in all drilled shafts for bridge foundations. AASHTO (2007) design specifications require that reinforcing for drilled shafts extend a minimum of 10 ft below the plane where the soil provides “fixity”, although fixity is not clearly defined and some judgment on this issue is left to the designer.

In virtually all designs, the reinforcement requirements will be greatest within the upper few diameters below the groundline and will diminish rapidly with depth. Therefore, the maximum number of longitudinal bars will be required in the upper section of a drilled shaft. Some of the bars can be eliminated, or "cut off," as depth increases. With some methods of construction, it is desirable that the cage should be able to stand on the bottom of the shaft excavation during the placement of the concrete (e.g. when extracting temporary casing), and thus at least some of the longitudinal bars must extend over the full length of the shaft.

In order for the reinforced concrete to function as designed, the longitudinal bars must bond to the concrete, and therefore the surface of the bars must be free of excessive rust, soil, oils, or other contaminants. Deformed bars are used to ensure that adequate bond to the concrete is achieved. As the concrete rises to displace the slurry around the rebar steel, there is a possibility that some of the water, bentonite, or polymer will be trapped around the deformations. As discussed in Chapter 7, there is no evidence at present to indicate that significant loss of bond may occur in wet construction if the slurry meets appropriate specifications at the time the concrete is placed.

It is conceptually possible to vary the spacing of the longitudinal bars and to orient the cage in a specific direction in the case where the main forces causing bending have a preferential direction. However, any small potential material savings that would be gained by such a procedure are generally more than offset by the risk of delays in the inspection and construction, or risks of misalignment or twisting of the cage. Therefore, the longitudinal bars are recommended to be spaced equally around the cage unless there are compelling reasons for nonsymmetrical spacing. If the number of bars in a symmetrical cage are at least six, then the bending resistance is almost equal in any direction. A view of the longitudinal steel in a rebar cage that is being assembled on a job site is shown in Figure 8-2.



Figure 8-2 View of a Rebar Cage Being Assembled, Showing Longitudinal Steel

The minimum clear spacing between longitudinal bars (and between transverse bars or spiral loops, as well) must be sufficient to allow free passage of the concrete through the cage and into the space between the cage and the borehole wall. This spacing is particularly important because drilled shaft concrete is placed without resorting to vibrating the concrete. Although this spacing is somewhat dependent upon other characteristics of the fluid concrete mix, the size of the largest coarse aggregate in the mix is an important characteristic. Recent research reported by Dees and Mullins (2005) suggest that a minimum spacing of 8 times the size of the largest coarse aggregate in the mix is needed to avoid blocking for tremie-placed concrete. Where tremie placement of concrete is anticipated, many agencies require a minimum opening between bars which is 5 inches in both the vertical and horizontal direction, and at least 10 times the size of the largest coarse aggregate in the mix. If concrete placement into a dry shaft is assured, then a smaller spacing on the order of 5 times the size of the largest coarse aggregate may be considered. The bar size that is selected for the longitudinal steel must be such that the proper clear



spacing between bars is maintained. The recommendations for minimum clear spacing should also apply to access tubes which may be included for non-destructive testing as described in Chapter 20.

In some instances, two or three bars can be clustered, or "bundled," together to increase the steel percentage while maintaining a cage with appropriate rebar spacing. Bundling of bars may require a greater development length beyond the zone of maximum moment. A photograph of a cage with bundles of two No. 18 bars is shown in Figure 8-3.



Figure 8-3 View of Bundles of No.18 Rebar in a Drilled Shaft Cage

Two concentric rebar cages have occasionally been used to provide an increased amount of steel for drilled shafts with unusually large bending moments. However, the two cages result in increased resistance to lateral concrete flow, and greatly increase the risk of defective concrete at the perimeter of the drilled shaft and in the space between the two cages. In such cases, consideration should be given to using high strength bars, bundled bars and/or increased diameter for the drilled shaft.

#### 8.4 TRANSVERSE REINFORCING

The transverse reinforcing steel has the function of: 1) resisting the shearing forces that act on a drilled shaft, 2) holding the longitudinal steel in place during construction, 3) providing the drilled shaft with sufficient resistance against compressive or flexural stresses, and 4) confining the concrete in the core of the cage to give the drilled shaft post-yield ductility. The transverse reinforcing steel is provided in the form of ties, hoops or spirals.

When either a transverse tie or spiral is used, it is essential that the end of the steel be anchored in the concrete for a distance sufficient to assure that the full bar capacity is achieved at the point of connection of the two ends of the tie or the end of one spiral section and the beginning of the next. Figure 8-4 shows two scenarios for providing such anchorage. On the left is a schematic of a series of transverse ties. It

shows the anchorage of the transverse ties being developed by the use of hooks. The hooks shown in the figure will complicate the assembly of the steel, and the protrusion of the bars into the interior of the cage could interfere with the introduction of a tremie or the placing of the concrete by free fall. The best practice is to anchor the transverse steel by the use of a sufficient amount of lapping. The use of sections of spiral anchored with a lap is illustrated on the right side of Figure 8-4. An extension of the steel beyond the point where its resistance is needed ("development length"), computed according to the relevant concrete design code, is recommended for the steel on each side of the connection point for all lap joints. ACI (1995) recommends in general a development length in inches of  $0.04A_b f_y / [f'_c]^{0.5}$  for bars of No. 11 size or smaller that take tension, such as transverse steel, where  $A_b$  is the cross sectional area of the bar in square inches,  $f_y$  is the yield strength of the steel in psi, and  $f'_c$  is the cylinder compression strength of the concrete, also in psi. Some agencies specify that spiral steel be lapped for one full turn.

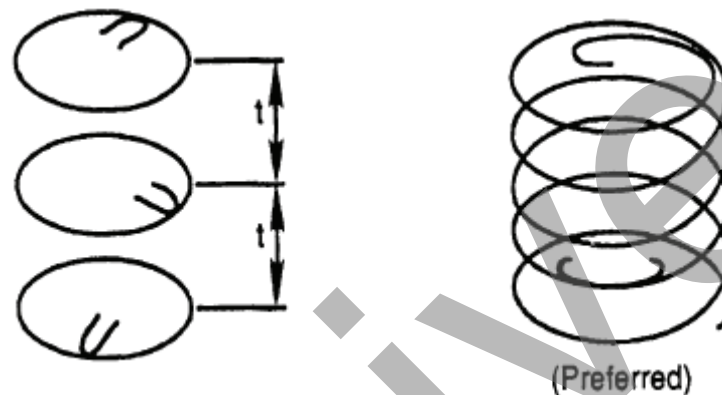


Figure 8-4 Transverse Ties and Spiral Steel, Showing Hook Anchors and Spiral Laps

Craftspeople assembling the reinforcing steel should be skilled in tying rebar so that the bars will maintain their relative positions as the concrete is poured. The cage should be assembled to resist the forces caused by the concrete as it flows from the inside of the cage. An undesirable displacement of the transverse steel is sketched in Figure 8-5. A frequent cause of that kind of deformation is that the steel in the transverse ties is too small. On some cages, No. 3 or No. 4 bars may satisfy structural requirements, but larger bars may be needed to prevent permanent distortion of the cage during handling and placement of concrete. The stability of rebar cages for drilled shafts during handling and concrete placement can be improved by completely tying every crossing between the longitudinal and transverse steel, rather than tying only some of the crossings, as is common practice in some localities.

It is possible, of course, to assemble the reinforcing steel by welding if the proper steel is at hand. But as noted earlier, weldable steel is not normally used for rebar cages in the United States (in Europe, it is more commonly available).

Note also that distortion of the cage can occur as hydraulic forces pull the top of the cage downward and laterally if concrete flows to one side of the excavation to fill a void or oversized excavation. These cavities can be hidden by casing and then cause distortion of the cage during removal of temporary casing. Where the potential for these conditions exists (for example, in karstic limestone or rock where large overbreak is possible), then it is especially important that the cage be carefully tied and supported during concrete placement and removal of casing. The cage and concrete mix properties should also be designed to ensure that good passing ability is present. Stiffeners (described subsequently) may be designed to remain in the cage during concrete placement.

Considerations for ductility in high moment regions near the top of the shaft, particularly in seismic regions, may indicate that relatively large amount of transverse reinforcement may be required. Tight spacing on spiral reinforcement (less than 5 inch pitch) can result in constructability problems with concrete flow through the cage. The photos in Figure 8-6 illustrate problems resulting from tightly spaced spiral reinforcement and a concrete mix with insufficient passing ability for this congested condition. The failure of the concrete to flow through the cage resulted in inadequate cover and poor contact between the soil and shaft.

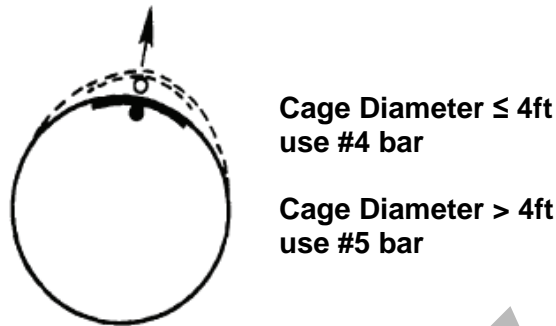


Figure 8-5 Possible Distortion of Poorly Assembled Cage Due to Pickup Forces or Hydraulic Forces from Fresh Concrete



Figure 8-6 Examples of Inadequate Flow of Concrete through Tightly Spaced Spiral Reinforcement

Several solutions exist for the constructability problems where high transverse reinforcement is required. One method used by Caltrans (Figure 8-7) is to utilize bundled hoops in order to increase the clear space between hoops to at least 5 inches. Another solution which may be appropriate in some circumstances is to utilize a permanent steel casing to provide confinement and ductility near the top of the drilled shaft. Even if the casing is not considered for contribution to flexural demands, the structural benefits of including a steel liner for confinement and ductility can be substantial. Finally, if very tight spiral spacing is utilized, a concrete mix specifically designed to provide high passing ability may be used. Concrete mixes are described in Chapter 9.



Figure 8-7 Bundled Hoops Used to Improve Flow of Concrete through Transverse Reinforcement

## 8.5 SPLICES

Splicing of the longitudinal reinforcement is required when the length of the cage exceeds the length of the available reinforcing bars, which is normally supplied in lengths of 60 ft or less. Splices in the longitudinal steel can be made by lapping the bars so that the bond in the rebar is sufficient to develop the full capacity of the bar in tension or compression in each bar at the point of the splice. An appropriate development length, as indicated in the governing code (e.g., AASHTO, 2007) is necessary in both bars on either side of the splice. The tie wire or clamps that are used to connect the bars must have sufficient strength to allow the cage to be lifted and placed in the borehole without permanent distortion of the cage. Weldable steel can be spliced by welding; although sometimes used in Europe, weldable reinforcing steel is not routinely used in U.S. practice.

Splices in the longitudinal steel, if required, should be staggered so all splices do not occur in the same horizontal plane along the rebar cage. Not more than 50 per cent of the splices should be at any one level. These guidelines are for constructability as well as structural considerations; if a large number of lap splices are placed at the same location, the splices can result in an obstruction to concrete flow as is the case on Figure 8-8.

Splices in the longitudinal steel can be made also by the use of special connectors, as illustrated in Figure 8-9. Although these various types of patented splice connectors are typically more expensive than lap splices, the use of these devices can reduce congestion in the cage. One such connector encloses the butt joint of two rebars, and the ignition of the patented material inside the connector results in a joint with considerable strength. Similar to lap splices, mechanical splices should be staggered for structural considerations.

Many structural designers prefer not to place any splices in zones near the location of maximum flexural stresses in the drilled shaft-column system when large lateral loads are anticipated (as when the design includes seismic considerations). Some agencies also avoid splices in zones where the probability of steel corrosion is the highest, such as splash zones in a marine environment.

There are cases where the cage is so long that it cannot be lifted conveniently in one piece, or where restricted vertical clearance precludes installation of a full length cage. In such a case, the cage can be spliced in the borehole. The lower portion of the cage is lifted, placed in the excavation, and held with its top at a convenient working level while the upper portion is lifted and positioned so that the two portions of the cage can be spliced together. Wire ties or clamps are usually employed to make the splices, with the ties or clamps in the longitudinal steel being staggered. The entire cage is then lowered to the correct position. Since concrete should be placed in the completed excavation as soon as possible after completion of drilling, time-consuming splicing in the hole should be minimized, or avoided if possible.



Figure 8-8 Constructability Problem from Excessive Concentration of Lap Splices



Figure 8-9 Bar Couplers Used to Construct Splices

## 8.6 CONNECTION BETWEEN DRILLED SHAFT AND COLUMN

Another constructability concern involves the fabrication of the connection between the drilled shaft reinforcement and the column. There are several possible approaches to the design of this connection, each of which has particular considerations in construction. A major factor relates to the tolerance in design of a splice near the top of the drilled shaft or base of the column, which may present a concern for ductility in a high moment area for seismic loading.

If the design allows a lap splice at the base of the column, a simple approach is to leave the shaft reinforcement sticking above the top of the shaft by a sufficient length to form the splice. This approach works best when the column is round and the diameter of the shaft and column reinforcing cage are of similar size. Typical requirements for concrete cover on column reinforcement are around 3 inches, and typical cover requirements for drilled shaft reinforcement are around 6 inches, so the cages will align best if the drilled shaft is specified to be 6 inches larger in diameter than the column. In addition, a planned 6 inch cover on the shaft reinforcement can allow this cage to be adjusted by 3 inches in any direction (the typical tolerance on location of the drilled shaft) so as to line up with the column cage and still maintain at least 3 inches of cover over the shaft cage. This concept is illustrated in Figure 8-10.

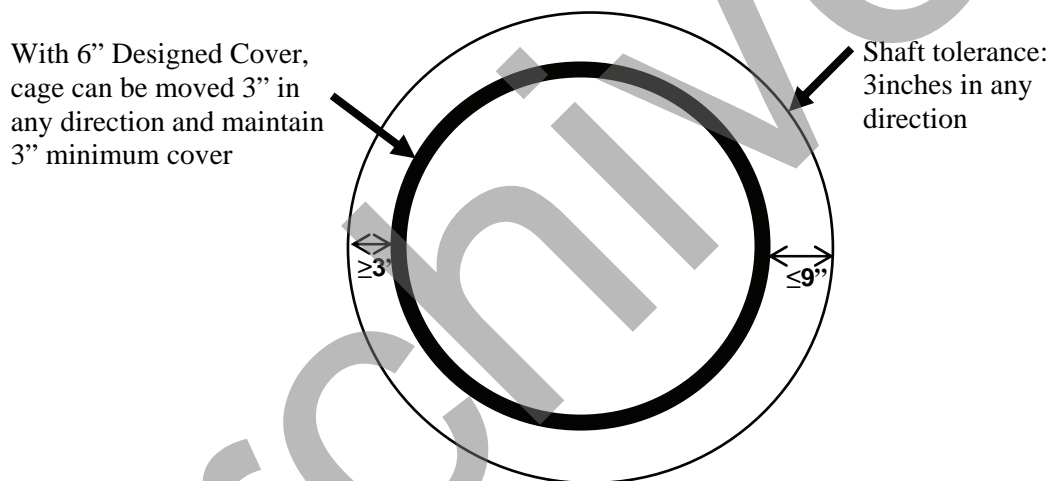


Figure 8-10 Adjustment to Drilled Shaft Reinforcement for Alignment to Column Cage

If a minimum 6-inch cover of the drilled shaft rebar cage must be maintained, the drilled shaft diameter towards the top of the shaft can be increased using surface casing.

Another method that is occasionally used to accommodate the location tolerance of the drilled shaft and to maintain the required concrete cover for the drilled shaft rebar cage, is to design the connection at the top of the column for the same offset tolerance as the drilled shaft. This approach allows the drilled shaft rebar cage to remain centered in the drilled shaft and the column steel can be spliced directly to the drilled shaft rebar cage.

If the design requires a continuous longitudinal cage extending from the shaft into the column with no splices near the ground line (sometimes referred to as a “Type I” connection in seismic areas), then the contractor may be forced to work over and around a cage which extends many feet above the top of the shaft. This often results in a very long cage that requires special handling by the contractor. This

approach will increase costs due to the need for bigger cranes to lift the taller cage and possibly extract casing high above grade. Concrete placement is also more complicated and expensive due to the projecting cage. The cage must be supported externally as the concrete is being placed and as it cures. The use of a planned 6 inch cover on the shaft reinforcement is desirable in this instance for the reasons as stated above. A Type I connection is shown in the left and center illustrations in Figure 8-11.

In some cases the design incorporates a drilled shaft which is significantly larger than the column and is designed to have greater moment resistance so that any damage from a seismic overstress condition is confined to the base of the column above grade. This approach is typically referred to as a “Type II” connection in seismic areas. A Type II connection is illustrated on the right in Figure 8-11. The normal approach is to extend the column reinforcement into the top of the shaft to form a “non-contact” lap splice for a sufficient distance to develop the strength of both the column and the shaft reinforcement. An example of such a connection is illustrated in Figure 8-12.

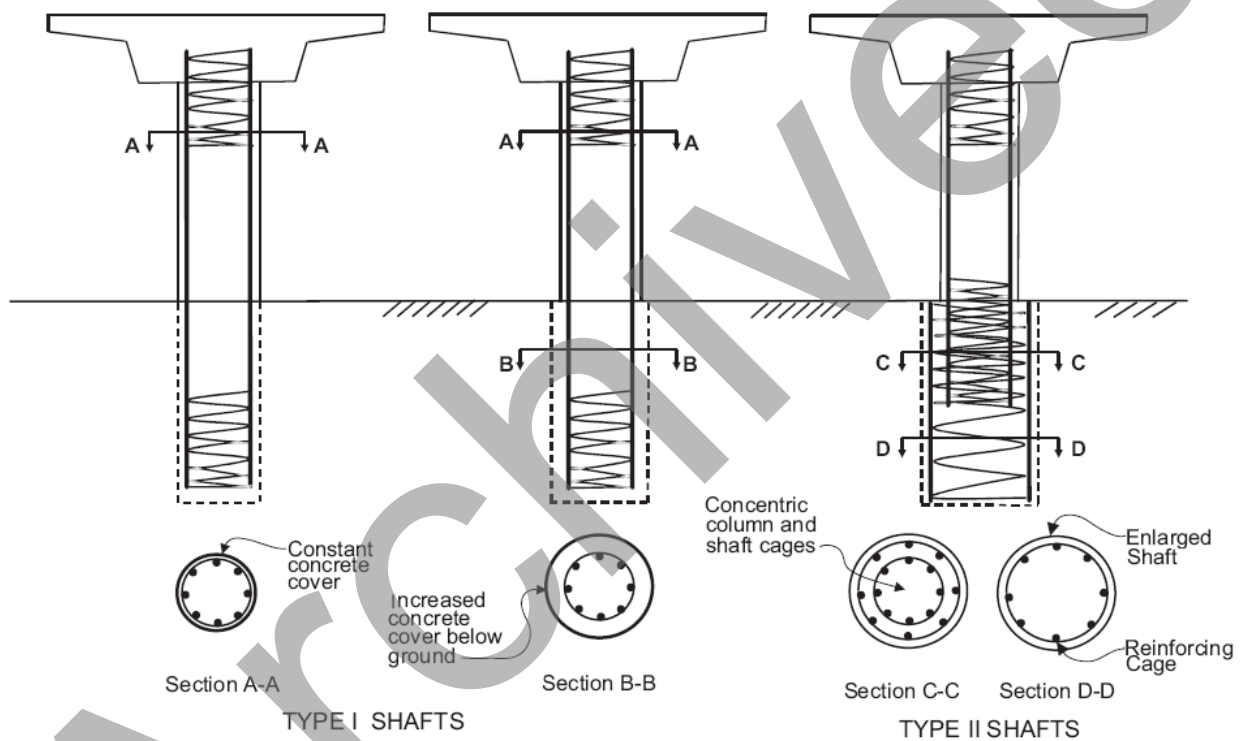


Figure 8-11 Type I and II Connections (from Caltrans Seismic Design Criteria, 2006)

A constructability issue can arise when a Type II connection must be fabricated using a single concrete placement in a wet hole environment, because the concrete would be required to flow through two cages. Even though appropriate openings are maintained in each cage, the openings will never line up from one cage to the next, and the opportunities for entrapping drilling fluids or poor quality concrete are significant. The best solution for construction of a Type II connection in a wet hole is to provide a short piece of permanent casing extending to a depth below the column reinforcement in order to allow a construction joint at the base of this splice as shown in Figure 8-13. When working over water, a short permanent casing combined with a larger diameter temporary casing or cofferdam can be used as illustrated in Figure 8-13. It is important that the shoring be of sufficient diameter to provide space for workers around the column formwork.

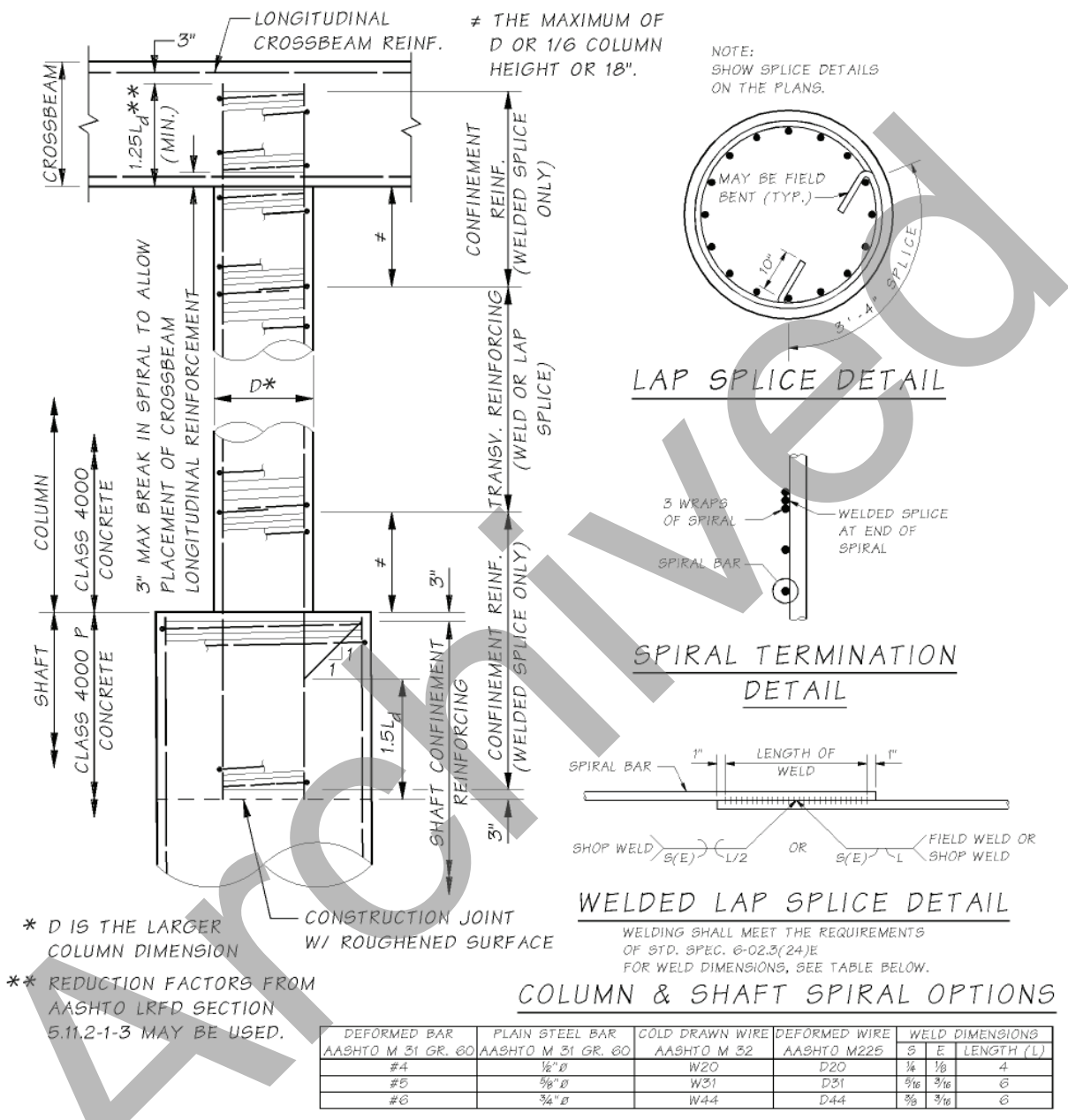


Figure 8-12 Washington DOT Type II Connection Detail (from WashDOT Substructure Design Manual, 2006)



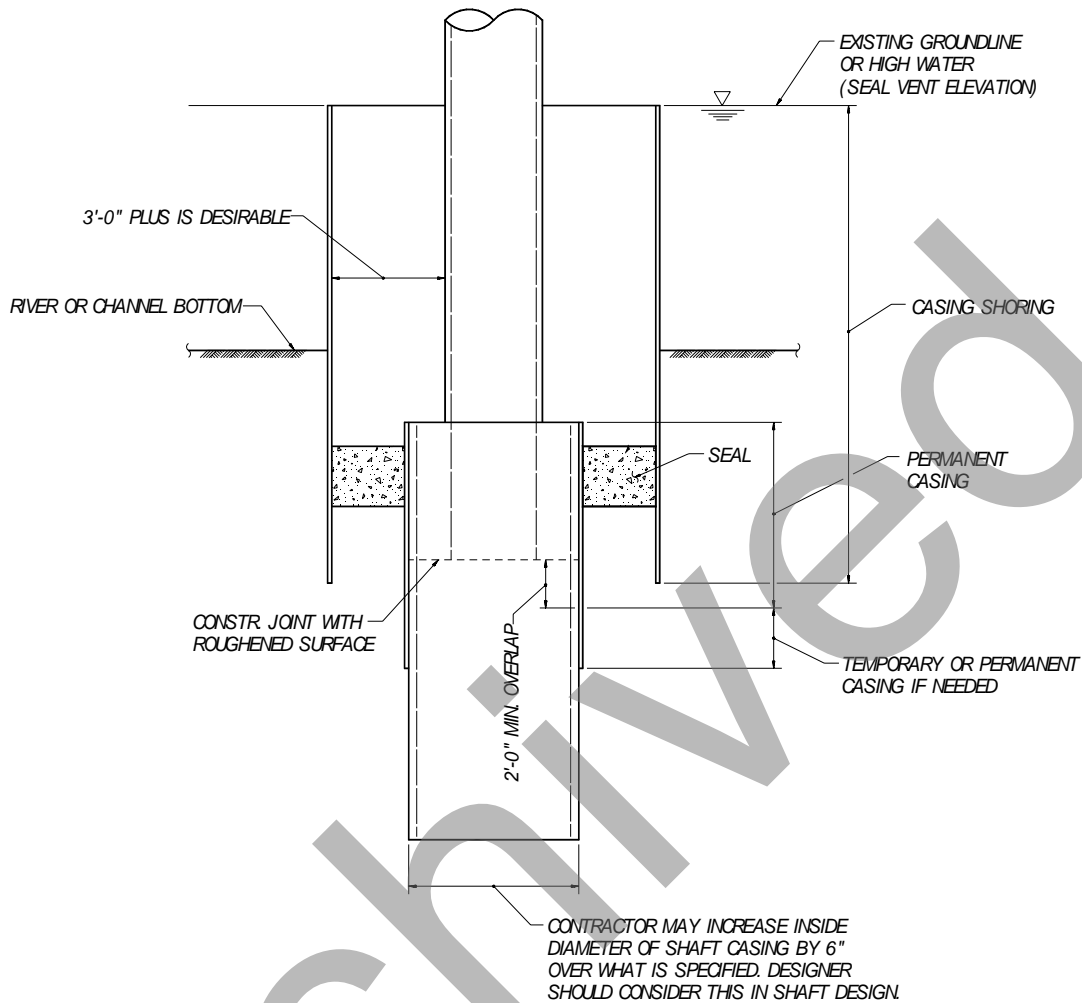


Figure 8-13 Construction of a Type II Connection Detail over Water (after ADSC West Coast Chapter)

Rather than extending the entire column reinforcing cage into the top of the drilled shaft, another approach which may be used to improve constructability is to use a shorter “splice cage” to provide a non-contact splice into the top of the drilled shaft and a lap splice into the column. This type of connection can also be advantageous where the column reinforcement is square or rectangular, as illustrated in the photo of Figure 8-14.

When the drilled shaft reinforcement includes a connection to a cap, grade beam, or abutment wall, it is important that the cage for the shaft should not include out-hook bars or other obstacles if temporary casing is used. In some cases, these can be turned inward during installation and then rotated into position after concrete placement is complete and temporary casing has been removed. Longitudinal bars can also be field bent hydraulically after the casing is removed. L-shaped bars or out-hooks could also be included into a secondary splice cage as described previously. The arrangement and spacing of the longitudinal bars of the drilled shaft must also accommodate passage of the bottom layer of rebars in the pile cap.



Figure 8-14 Splice Cage Used to Fabricate Column to Shaft Connection

## 8.7 SIZING HOOPS

Sizing hoops of the proper diameter are often constructed to aid in the fabrication of the rebar cage and to ensure that the finished cage diameter is correct. The hoops simply provide guides for the fabrication of the cage and can be made of plain rebar or thin rolled-plate stock. The sizing hoop, sometimes called a "gauge hoop," can be made with a lapped splice as illustrated on the left side of Figure 8-15, but the ends of the hoop can also be butt-welded, as illustrated on the right side of that figure. Marks on the sizing hoops will facilitate the placing of the longitudinal steel. Although sizing hoops give the finished cage some additional dimensional stability, they serve no structural purpose. Therefore, butt welding on non-weldable steel should not be prohibited.

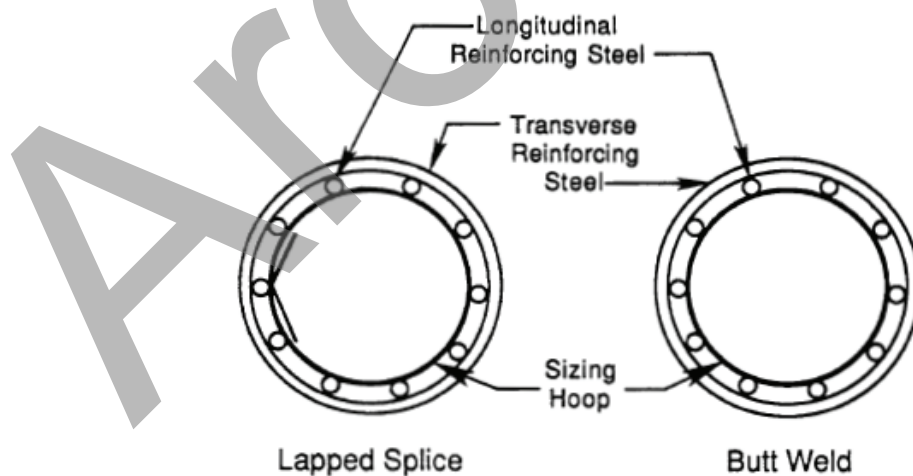


Figure 8-15 Sizing Hoop Assembly (from Le Laboratoire Central des Ponts et Chaussées, 1986)

## 8.8 CENTERING DEVICES

The completed rebar cage must be sized to provide ample room for the fresh concrete to flow up the annular space between the cage and the sides of the excavation, as well as to provide adequate cover for the rebar. In accordance with AASHTO, minimum concrete cover should be 3 inches for drilled shafts with diameters up to 3 ft; 4 inches for diameters greater than 3 ft and less than 5 ft; and 6 inches for drilled shaft diameters of 5 ft and larger. In addition, the minimum annular space should be not less than five times the largest size of coarse aggregate in the concrete mix. As indicated in previous sections, a planned cover of 6 inches, or more, has advantages for individual shafts supporting a single column. The most effective means to assure that the cage is held an appropriate distance away from the walls of the borehole or casing during the concrete placement is by means of centering devices. Centering devices may also be used on the interior of the cage to guide the tremie in a wet-hole concrete placement operation.

Centering devices should be composed of rollers aligned so as to allow the travel of the cage along the wall of the drilled shaft excavation without dislodging soil or debris and causing the accumulation of loose material in the bottom of the excavation prior to concrete placement. These rollers are typically constructed of plastic, concrete, or mortar; they should not be fabricated of steel in such a way that a corrosion path to the reinforcement could be introduced. Some examples of centering rollers are provided in the photos of Figure 8-16.



Figure 8-16 Roller Centralizers on Reinforcing Cage. Clockwise from top left: mounting external roller centralizer on the cage; completed cage with centralizers; rollers attached to hoop reinforcement; extracted shaft revealing centralizer on surface.

Flat or crescent shaped centralizers (“sleds”) should not be used in an uncased shaft since they increase the risk of material being dislodged from the side of the excavation and accumulating debris at the base of the drilled shaft excavation.

Some specifications also call for the base of the drilled shaft cage to be suspended off the soil or rock at the bottom of the borehole in order to impede rebar corrosion. These devices can also be used to reduce bearing pressure under the longitudinal bars from the weight of the cage and prevent the rebar from penetrating into the soil in a case where the weight of the cage is supported on the base of the excavation. Small concrete, mortar or plastic "chairs" can be made or used for this purpose, as illustrated in Figure 8-17. The photo at right shows the base of the concrete shaft after the shaft was extracted (for research purposes) in which the plastic chairs are evident.



Figure 8-17 Chairs for Base of Reinforcing Cage

## 8.9 STRENGTHENING THE CAGE TO RESIST LIFTING FORCES

A critical stage in the construction of a drilled shaft is when the cage is lifted from a horizontal position on the ground (its orientation when fabricated), rotated to the vertical, and lowered into the borehole. Temporary or permanent stiffening may be necessary to strengthen the cage against distortion during lifting operations. Figure 8-18 provides photos of transverse and longitudinal stiffeners that are tied to the reinforcing cage. These stiffeners should generally be removed as the cage is held vertically and lowered into the drilled shaft excavation to reduce obstructions when the tremie or pump line is lowered into the excavation. The types of stiffeners shown in Figure 8-18 should be tied, not welded, to the rebar cage. The stiffeners shown in Figure 8-19 are tack-welded to the sizing hoops, since neither the stiffeners or sizing hoops are part of the structural reinforcement for design.

Many contractors prefer to brace rebar cages externally so there is no need to remove bracing as the cage is placed. One way of doing this is to use a "strongback" or section of pipe or wide flange section tied to the cage while it is being lifted.



Figure 8-18 Transverse and Longitudinal Stiffeners for Temporary Strengthening of the Rebar Cage



Figure 8-19 Transverse Stiffeners Attached with Tack-Welds to Sizing Hoops

### 8.10 ARRANGEMENTS FOR LIFTING CAGE

The rebar cage can be lifted from its horizontal position to the vertical in preparation for placing the cage in the borehole, with the use of slings or temporary attachments that are provided by the personnel on the job or by lifting hoops tied to the cage. Lifting from several longitudinal rebars, rather than just one bar, at each pickup point is desirable. Careless lifting of a cage may result in permanent distortion of the rebar. For example, the cage being lifted in Figure 8-20 was permanently distorted and had to be disqualified for use in a drilled shaft because an insufficient number of pickup points were used. A more appropriate procedure is shown in Figure 8-21. Although some small amount of distortion is visible in Figure 8-21, the magnitude shown is all elastic, and the cage is free of any permanent distortion when it is in its vertical position.



Figure 8-20 Photograph of Rebar Cage Being Lifted Improperly (Photo courtesy of Barry Berkovitz, FHWA)



Figure 8-21 Photograph of Rebar Cage Being Lifted Properly

Elastic deformation of a cage during lifting is of no great concern; however, if plastic (permanent) deformation occurs or slippage of the ties or spiral is evident after the cage is brought to the vertical, the cage must be repaired before placing it in the borehole. When the construction operation requires that the cage be self-supported by standing the cage on the bottom of the shaft excavation, it is particularly important that the cage be well-tied and free of distortion from the lifting operation.

As mentioned in the previous section, external support from a “strong-back” composed of structural beams may be used to help lift the cage to the vertical position. These elements may be lifted with the cage, although the weight of the external beam increases the weight of the lift. The photo of Figure 8-22 illustrates the use of a “tipping frame” mounted on a barge and used to help lift the cage into the vertical position in marine construction.

Following lifting of the rebar cage, additional roller centralizers should be attached to the rebar cage to replace those damaged or missing from the cage.



Figure 8-22 Photograph of Rebar Cage Being Lifted with a Tipping Frame (photo courtesy Malcolm Drilling)

## 8.11 FABRICATION AND STORAGE

The fabrication of rebar cages can be done most conveniently in a fabrication yard, but there is the problem and expense of transporting the cages to the job site. There are often restrictions about the moving of over-length loads on roads and streets, but sometimes the jobsite is so confined or congested that offsite fabrication is necessary. The photo in Figure 8-23 shows a crane offloading a large cage which had been transported to the congested construction site alongside an existing freeway.

For most projects, the usual procedure is to transport the rebar to the job site and to assemble the cage reasonably close to where the cage is to be installed. Cage transportation is eliminated, and handling of the completed cage is reduced to a minimum -- usually only to pick up the cage with a crane or cranes, and placing it in the shaft excavation. The photographs in Figure 8-1 through Figure 8-3 show workers fabricating rebar cages at a job site. The frames, or “jigs”, that are shown for the temporary support of the cage are often necessary to fabricate large diameter cages correctly.



Figure 8-23 Photograph of Rebar Cage Being Delivered to Site

In rare occasions, the constructor may fabricate the cage directly over or in the drilled shaft excavation. The photos in Figure 8-24 show the fabrication of a large diameter cage by suspending the longitudinal bars from a “wind-chime” hangar frame and the adding the transverse hoops as the assembly of longitudinal bars is lowered into the hole. The example shown had permanent casing extending to rock. This procedure, however, should generally be avoided in uncased holes since it increases the time that the shaft excavation is open and increases the associated risks of hole instability and surface degradation.



Figure 8-24 Photograph of Rebar Cage Being Assembled Over the Shaft Excavation



The usual procedure is that a number of cages are fabricated prior to drilling the boreholes and stored at the job site until a particular cage is needed. This procedure allows the cage to be placed in the borehole in a timely manner following completion of excavation and inspection. Proper arrangements should be made to keep the stored cages free from contamination with mud or other deleterious materials.

## **8.12 SUMMARY**

This chapter provides an overview of the properties of reinforcement used in the design and construction of drilled shafts and the special considerations related to constructability of drilled shaft reinforcement. Compared to columns or other reinforced concrete structures, drilled shaft construction presents different considerations for handling and fabrication of the cage. The design of the cage must ensure concrete passing ability and provide for construction tolerances. The design of splices and connections to the structure must include considerations for construction procedures. The handling and placement of the reinforcement into the drilled shaft excavation must be planned and executed with care to ensure that the structural requirements provided by the reinforcing are achieved. These many and sometimes conflicting considerations can only be addressed effectively if engineers have a good understanding of the special construction requirements of drilled shafts, and if constructors are properly equipped and trained and have a well-designed installation plan.

Archived

This page is intentional left blank.

## CHAPTER 9 PLACEMENT AND DESIGN OF CONCRETE FOR DRILLED SHAFTS

### 9.1 INTRODUCTION

The construction of a drilled shaft foundation can be thought of as the fabrication of a reinforced concrete structure in-situ. This aspect of the manufacture of the foundation structure is often conducted under extremely challenging conditions with underwater placement of reinforcing and concrete at depths exceeding 100 ft below the ground surface. Concrete placement techniques and materials represent a critical aspect of the process and require thorough planning and design. The mix design, and the means and method of concrete placement are most often delegated to the contractor, with submittals required for approval by the engineer/owner/agency. It is imperative that all stakeholders in the process have a good understanding of the basic requirements and characteristics of drilled shaft concrete.

This chapter describes the placement of concrete for drilled shafts, and the design and testing of concrete mixes with emphasis on the unique requirements of drilled shaft concrete. This chapter will focus on the specific issues of greatest import to drilled shaft construction and performance, emphasizing the workability characteristics critical to success in this application. Testing for quality control and quality assurance during batching and concrete placement is described in this chapter; integrity testing of completed drilled shafts is described in Chapter 20.

### 9.2 BASIC CHARACTERISTICS OF DRILLED SHAFT CONCRETE

Because of the unique construction techniques used for drilled shafts compared to other reinforced concrete structures, the concrete used must be designed for the specific requirements of this application. The most unique and important of these involve the workability requirements for the fresh concrete during transport and placement operations. Oftentimes the mix must be transported long distances to a remote bridge site to be pumped long distances to then flow readily through a tremie and congested reinforcement under slurry to fill a hole which may be 10 ft diameter at depths exceeding 100 ft, and the mix may be required to stay fluid for periods of 4 to 8 hours or more in widely ranging ambient temperature conditions. In addition, the mix must consolidate under its own self weight without vibration and without segregation, excessive bleeding, or heat of hydration. A challenging set of circumstances to be sure, but not uncommon with modern drilled shaft construction.

Drilled shaft concrete and aspects of construction of drilled shafts related to concrete are discussed in ACI 336.1 (2001), which is recommended as parallel reading for this chapter. The publication “Design and Control of Concrete Mixtures” (Kosmatka et al, 2002) is appropriate background reading for the reader who is not familiar with concrete mixtures in general or with terminology related to concrete.

The basic characteristics of concrete for drilled shafts can be summarized as follows:

- **Filling Ability:** It is essential that the concrete have the ability to flow readily through the tremie to fill the shaft excavation and restore the lateral stress against the sides of the borehole. In some cases, the concrete may be placed to fill a casing and then the casing removed some minutes or hours later at which time the concrete must again flow laterally to displace fluids and fill the excavation. This objective can best be met by using concrete that is highly fluid and by ensuring that the reinforcement cage is designed to allow the concrete to pass through it.

- Passing Ability: The concrete must readily pass through the reinforcement without blocking. Even with a highly fluid mix, the aggregate size and gradation must be proportioned so that the concrete can pass through small openings without blocking.
- Self-weight Compaction: Vibration of concrete in a borehole is not possible (due to depths and time required) or desirable (due to underwater placement) in deep drilled shafts, and the concrete must fill and consolidate under self weight.
- Resistance to Segregation and Bleeding: The paste within the concrete mix should have a high degree of cohesion so that the coarse aggregate particles are evenly distributed through the mix without any tendency to segregate. Likewise, the water within the mix should remain distributed without a tendency to bleed and result in non-uniform properties or bleed water channels.
- Resistance to Leaching: When concrete is placed under a drilling fluid (slurry or water), there is inevitable contact between the concrete and the fluid. The mix must have a cohesive nature that is resistant to mixing with external fluid and leaching.
- Controlled Setting: With underwater placement or when casing must be withdrawn after completion of concrete placement, the drilled shaft concrete must retain its workability throughout the time required for completion of placement operations.
- Durability: The concrete cover on the reinforcement must provide low permeability so as to minimize the potential for corrosion of the reinforcing. If the subsurface environment is aggressive or can become aggressive during the life of the foundation, the concrete should be designed to have high density and low permeability so that the concrete is able to resist the negative effects of the environment.
- Low Heat of Hydration: For some large-diameter drilled shafts, the volume of concrete placed may be sufficient to require measures to prevent excessive heat of hydration as would be associated with mass concrete. The temperature of the mix can also be a concern during hot weather concrete operations. High in-place temperatures must be controlled so that conditions do not lead to delayed ettringite formation (which causes cracking and may result in loss of load carrying capacity) or that excessive thermal gradients do not produce thermal cracking.
- Appropriate Strength and Stiffness: The concrete must provide the strength and stiffness necessary to meet the structural performance requirements.

In most cases, drilled shafts are not subject to high structural stresses within the concrete and so the strength demands are relatively ordinary compared to the extreme workability requirements cited above. The following section outlines recommended construction practices for concrete placement. A complete understanding of the concrete placement requirements during construction of drilled shafts is necessary in order to develop a mix design with the appropriate workability characteristics for the specific needs of a project.

### **9.3 PLACEMENT OF CONCRETE**

Concrete placement in a drilled shaft excavation must be carefully planned and executed to meet the specific conditions associated with the different methods of construction described in Chapter 4. The following sections describe the procedures used with concrete placement in dry and wet excavations, and with the considerations necessary for temporary casing.

### 9.3.1 Placement in a Dry Shaft Excavation

A dry excavation without removable casing provides the simplest conditions for concrete placement operations. In most cases, concrete can be placed by free fall methods so long as the concrete is directed down through the center of the shaft without directly hitting the reinforcing cage or the sides of the hole. The impact of the concrete against the reinforcement cage could produce distortion of the cage or segregation in the concrete. If concrete hits the sides of the hole, soil or debris could be knocked into the fresh concrete during placement.

The flow of the concrete in free fall should be directed to the center of the borehole and cage by a drop chute or other acceptable device to keep the stream of falling concrete centered in the hole. Laborers with shovels are not generally able to direct the stream of concrete adequately. A drop chute can be composed of a short section of relatively stiff or rigid pipe; flexible hose is not recommended because of the difficulty in directing the discharge from a flexible hose. In cases where the truck can locate very near the top of the shaft, the last section of the chute from the concrete truck can often be used to direct the flow as illustrated in Figure 9-1. Figure 9-2 illustrates a case in which the concrete was lifted to the top of the column reinforcing using buckets and placed into the dry excavation via the drop chute. In this example the drop chute is a simple stiff plastic tube attached to a funnel at the top. Note also that a tremie pipe (described in Section 9.3.3) may also be used as a simple drop chute if a dry shaft excavation is achieved.

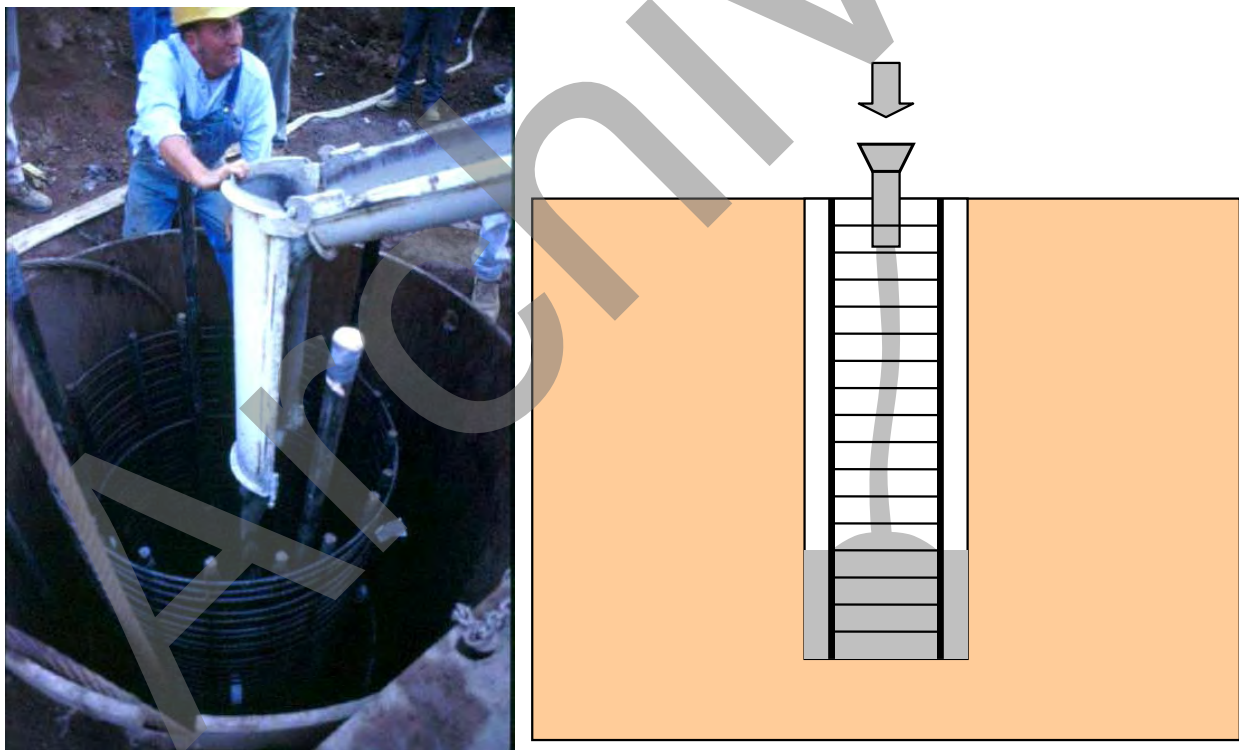


Figure 9-1 Free Fall Concrete Placement in a Dry Excavation



Figure 9-2 Placement into a Dry Excavation Using a Drop Chute

### 9.3.1.1 Effects of Free Fall Placement of Concrete

Several detailed studies have been conducted to investigate the effects of free fall on drilled shaft concrete. Baker and Gnaedinger (1960) report a study on the influence of free fall on the quality of concrete. The concrete was placed in an excavation that was 36 inches in diameter and 80 ft deep. The concrete was guided at the top of the excavation and allowed to fall freely without striking the sides of the excavation. The design of the concrete called for a strength of 5,000 psi at 28 days. After the concrete had set for approximately two weeks, the drilled shaft was cored, and cores examined visually. An excavation was made to a depth of 50 ft along the side of the shaft, and the strength of the concrete was tested by use of a Schmidt hammer. Free fall was found not to result in any observable segregation of the mix, and the compressive strength of the concrete was not reduced.

Bru et al. (1991) describe studies made at the Laboratoires des Ponts et Chaussées in France in which cohesive concrete was allowed to fall freely for 30 ft without striking rebar or the side of the borehole. No evidence of strength loss in the concrete in the bottom 2 ft was observed based on wave velocity measurements.

Kiefer and Baker (1994) conducted a detailed parametric field study of the effects of free fall, in which the slump and coarse aggregate size of the concrete were varied, superplasticizers were used in some mixes and some drops were made through the reinforcing steel. The slump varied from 4 to 8 inches, the coarse aggregate size varied from 5/8 to 1-1/4 inch; a retarder was used in the mix; and the water to cementitious material (w/cm) ratio was held constant at 0.53. The diameter of the cage was 36 inches and maximum drop height was 60 ft. There were 5 to 5-1/3 sacks of Portland cement and a weight of fly ash equivalent to about 1 sack of Portland cement per cubic yard, together with enough fine aggregate to make a cohesive concrete mix. Core samples were recovered and Schmidt hammer tests were performed, and access shafts were made to permit observation of the concrete in the constructed shafts. No loss in compressive strength or segregation in the concrete was observed when the concrete was dropped

centrally inside the cages with any of the mix variations indicated above. In fact, there was a slight positive correlation between drop height, density of the cores and compressive strength, suggesting that the impact of the free-fallen concrete drove out air, produced denser concrete, and thereby produced stronger concrete. Similar results were obtained when the w/cm ratio was reduced and high-range water reducers were added. Dropping the concrete in such a manner that it fell through the rebar cage did not, in most cases, result in reduced strength or increased segregation, although this action did result in moving the cage off position and some contamination of the concrete as it traveled down the soil sides of the borehole.

It appears, therefore, that concrete can be dropped freely for distances up to about 80 ft without problems as long as the concrete does not strike the cage or the borehole wall. Kiefer and Baker (1994) report that keeping the concrete stream away from the rebar cage was not a problem for a depth-to-cage-diameter ratio of 24 or less, and they suggest that free fall could be used to a depth of 120 ft in a 5-ft diameter cage based on these tests and construction experiences with large-diameter, deep drilled shafts in the Chicago area.

### 9.3.1.2 How Dry is “Dry”

If the shaft excavation is not completely dry and the concrete is placed by free fall, then there will be mixing of the concrete with the water which is present at the base of the shaft. The result would be a concrete mix with excessive water or perhaps even a zone of washed aggregate if a substantial amount of water is present. The contractor can often pump out water so that an unobjectionable small (less than 3 inches) depth remains, and this method is sufficient so long as there is not a substantial inflow of water. In general, a flow into the excavation producing more than 12 inches of water per hour (1 inch per 5 minutes) is considered excessive. If excessive seepage occurs as shown in Figure 9-3, it is necessary to flood the excavation to avoid the inflow, and place concrete using a wet method as described subsequently. It may not be sufficient to simply use a tremie without flooding the excavation to control inflow, because water inflow may have a pressure head greater than the head of concrete during the placement operations and thus could result in the formation of flow channels of water into or through the fresh concrete. By flooding the excavation and placing concrete with a tremie, the higher fluid head within the shaft excavation will maintain a positive outward direction of flow until the fluid concrete has filled the hole.

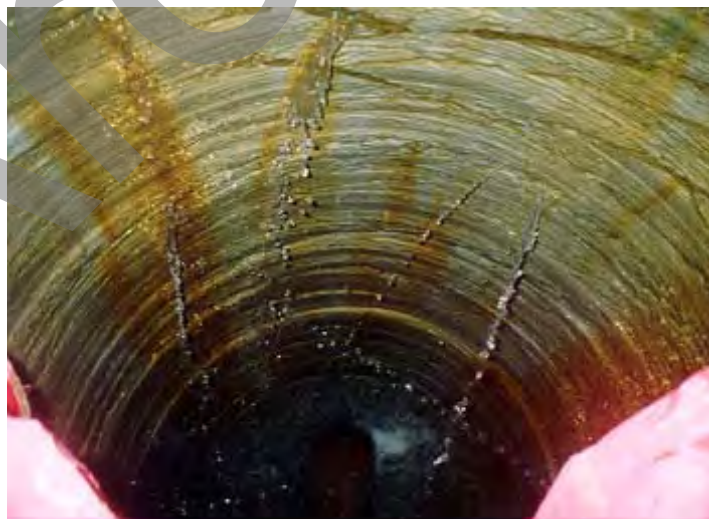


Figure 9-3 Excessive Seepage Precludes Free Fall Placement of Concrete (PennDOT photo)

### 9.3.2 Placement in a Dry Shaft Excavation within a Cased Hole

The previous section described placement of concrete within a dry shaft excavation. In some cases the excavation may be dry, but the dry condition is achieved by the use of temporary casing extending through water-bearing strata. Some additional considerations are necessary for concrete placement in a cased hole in which temporary casing will be removed.

Where temporary casing has been used to seal the dry shaft excavation, there may be an accumulation of fluid on the outside of the casing. At the time the casing seal is broken to remove the casing, the head of concrete inside the casing must be at a sufficient level that the concrete pressure exceeds the fluid pressure on the outside of the casing, and this concrete head must be maintained to avoid the potential for inflow of the fluids into the fresh concrete (i.e., a breach of the casing). The head of concrete within the casing will drop as concrete flows out to fill the annular space and any voids outside the casing. The concrete pressure head requirement is illustrated in Figure 9-4. Note that the fluid outside the casing is often heavily laden with silt and sand such that the unit weight may be significantly greater than the unit weight of water. In addition, the concrete pressure at the base of the casing will be somewhat less than the measured head within the cage near the tremie due to losses in head across the reinforcing cage as the concrete flows out of the casing to fill the space outside the casing. Therefore, it is necessary to maintain a substantial margin of excess head above the theoretical computed head difference illustrated in Figure 9-4 in order to minimize risks of water or slurry inflow into the drilled shaft concrete.

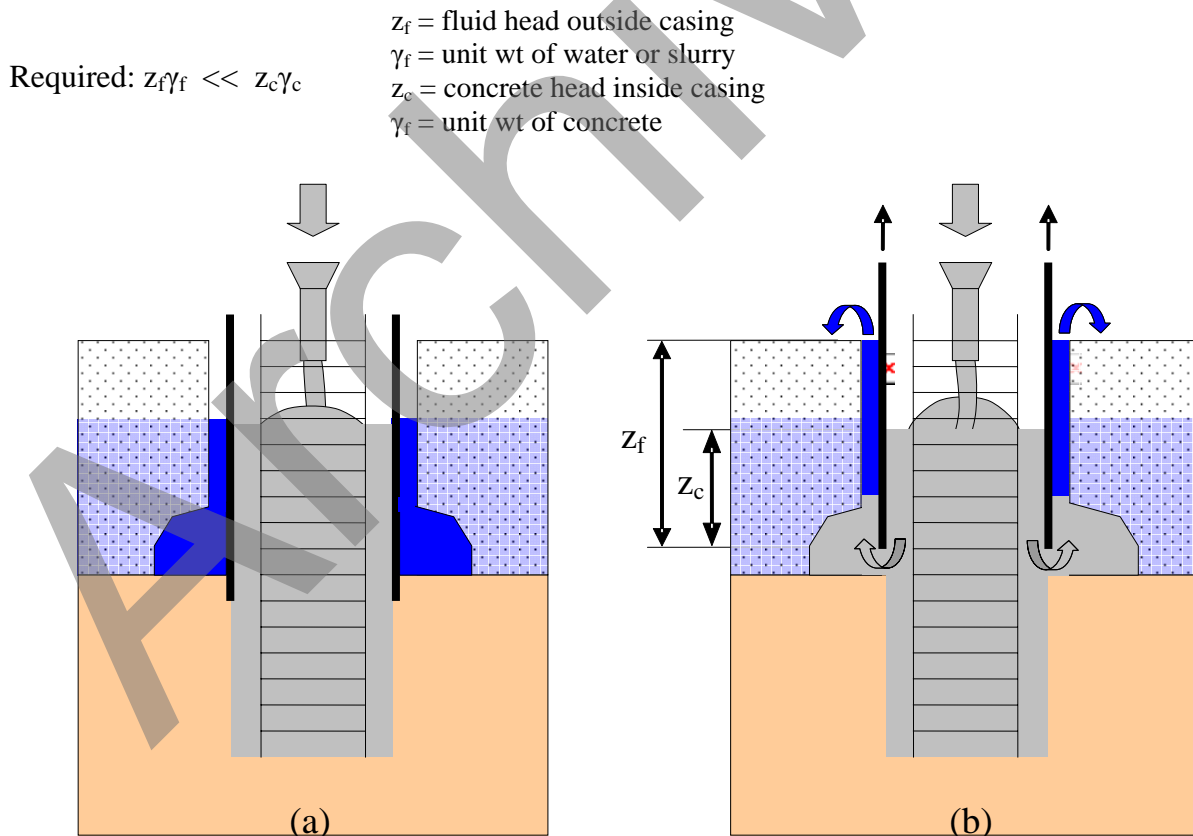


Figure 9-4 Concrete Pressure Head Requirement During Casing Extraction: (a) Prior to Lifting Casing; (b) as Casing is Lifted



The requirement to provide sufficient concrete to overcome external fluid pressure is complicated by the possibility that there could be overbreak or cavities of unknown size on the outside of the casing. When the casing is pulled and the seal into the underlying formation is eliminated, the head of concrete within the casing will drop immediately due to the volume required to fill this space. It is therefore essential that concrete be supplied at a sufficient rate to maintain a positive pressure head of concrete inside the casing in excess of the fluid pressure head to the ground surface outside the casing, as illustrated in Figure 9-4. The photo in Figure 9-5 illustrates the expulsion of fluids from the space around the casing to the surface as fluid concrete fills the excavation from the bottom.



Figure 9-5 Slurry Displaced from Annular Space during Casing Extraction

It is also essential that the concrete have good workability throughout the duration of the placement operations. The concrete must flow easily through the cage to displace fluids and completely fill the excavation. Even with dry conditions outside the casing, a loss of concrete workability prior to casing extraction could result in arching within the casing such that concrete is lifted and a “neck” occurs below the casing. This condition can also result in displacement of the reinforcement or inability to remove the casing. Concrete which does not flow readily through the reinforcing will tend to load the cage vertically and may tend to cause racking or distortion in the reinforcing cage. If there is a void outside the casing on one side of the shaft, concrete with poor workability may tend to drag the cage toward the side with the flow, resulting in downward movement and distortion of the cage.

Where telescoping temporary casing is used (see Section 6.1.2.1), it is important that concrete fill from the bottom up as each section is removed. In general, the concrete should fill from the inside out, and casing extraction must be carefully managed to prevent entrapment of any water within the concrete. An illustration of extraction of telescoping casing during concrete placement is provided in Figure 9-6. Note that the initial placement of concrete into the deeper casing (a) must be directed so as to prevent spillage of concrete into the annular space between casings. During extraction of the inner casing, shown in Figure 9-6b, the concrete head must be maintained within the inner casing sufficient to exceed the head of any fluid outside the casing. The contractor may choose to first extract the inner casing, displacing fluid in the annular space up and over the outer casing, or may choose to remove the outer casing first while maintaining a head of concrete within the inner casing. In either case, the removal of the outer casing introduces the opportunity for concrete to flow out and fill overbreak volume as described previously.

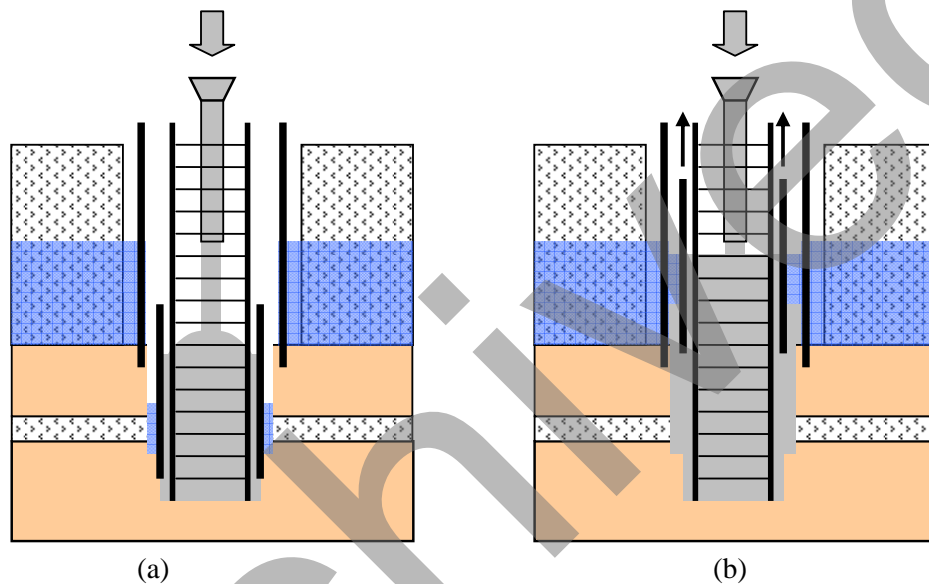


Figure 9-6 Concrete Placement with Telescoping Casing: (a) Initial Placement of Concrete; (b) Initial Extraction of Inner Casing

### 9.3.3 Placement of Concrete in a Wet Excavation

Where a wet excavation is required for construction or a sufficiently dry excavation cannot be maintained (as described in Section 9.3.1.2), then concrete must be placed using underwater techniques with either a tremie or pumpline. In each case, it is essential that the concrete have good workability for the duration of the placement operations and that the bottom of the concrete delivery tube be maintained sufficiently deep below the rising surface of fresh concrete. Both systems have been used successfully, although the gravity tremie is more common, especially with relatively deep (greater than 60 ft) shafts.

#### 9.3.3.1 Placement by Gravity Tremie

A gravity-fed tremie is a steel tube, usually with a hopper on the top, which is fed from a pump or by discharging from a bucket or directly from a ready mix truck. Aluminum should never be used because of reactions with the concrete, and plastic pipe such as PVC is generally not sufficiently robust. The diameter of a tremie tube for gravity placement of concrete depends on the diameter and depth of the

excavation; tremie pipes with an inside diameter of 8 to 12 inches are most common, although larger diameters may be used. A 10-inch diameter is generally the smallest that should be used for a gravity tremie.

The tremie must be watertight to prevent inflow of slurry during concrete placement, and must have a smooth and clean inner surface to minimize drag on the concrete flow. A tremie with obstructions or hardened concrete on the inside will increase frictional resistance to the concrete flow and may cause a blockage. The tremie in Figure 9-7a is contaminated with hardened concrete and must be cleaned or discarded. The worker in Figure 9-7b is cleaning a section of tremie by knocking the outside with a hammer. A smooth outer surface is desirable in order to avoid entanglement with the reinforcing cage, although tremies with flanges protruding on the outside (such as those in Figure 9-7) have been used successfully if the verticality of the tremie can be controlled and the cage is large enough to permit passage of the flanges.

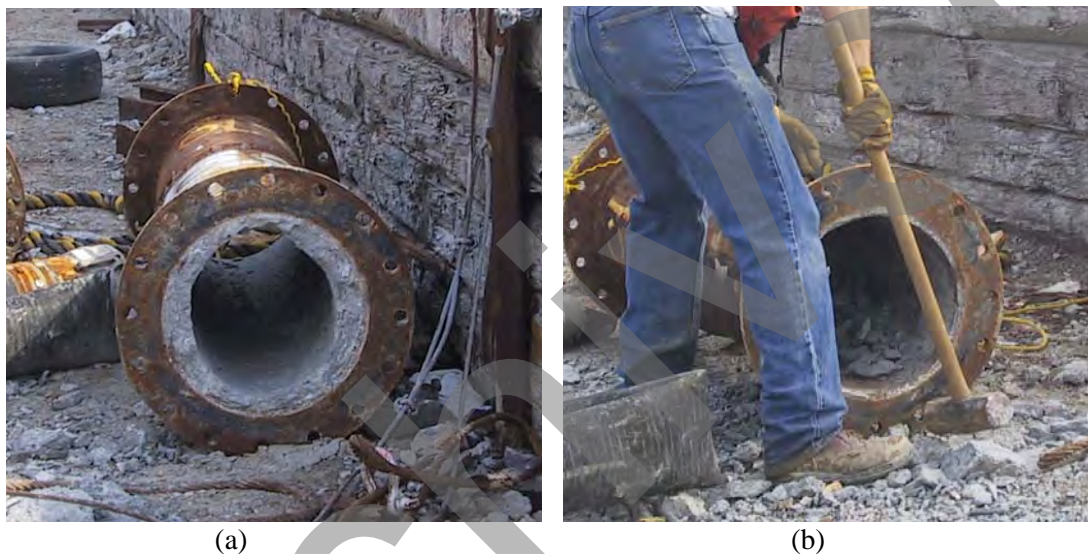


Figure 9-7 Tremie Must be Clean; (a) Tremie Contaminated with Hardened Concrete; (b) Worker Cleaning Tremie

In a relatively short shaft (usually less than 40 to 50 ft long), a solid, one-piece steel tube may be used as a tremie as shown in Figure 9-8. Deeper drilled shafts typically require use of a sectional or segmental tremie. A segmental tremie is assembled from sections with waterproof joints as illustrated in Figure 9-9. Several types of joints are available, usually designed to include an o-ring seal. Segmental tremies can be disassembled as they are being extracted from the excavation, which minimizes the height that concrete must be pumped or lifted by bucket to charge the tremie.

With water or slurry in the excavation, the concrete flow from the tremie must be initiated so that there is a minimum of contamination of the concrete. Two general procedures may be used:

1. A closed tremie may be installed with the bottom of the tremie sealed with a cover plate
2. An open tremie may be installed and a traveling plug inserted ahead of the concrete.

Both of these methods require careful attention to details during initiation of concrete placement in the shaft.



Figure 9-8 Solid Tremie Pipes



Figure 9-9 Assembly of Segmental Tremie for Concrete Placement

The closed tremie is placed into the shaft, concrete placed within the tremie, and then the tremie opened to release the concrete. The closed tremie must be watertight to avoid mixing of concrete with water or slurry inside the tremie. After placement of the tremie into the shaft, the inside of the tremie should be visually checked for leaks before placement of concrete into the tremie. The buoyancy of a watertight closed tremie is one limitation of the use of this method relative to an open tremie; in some situations it may be necessary to add weight to make the closed tremie sufficiently heavy to overcome buoyancy.

A seal at the bottom of closed tremie is normally provided using a sacrificial closure plate. This closure plate can be a simple steel, sometimes with a rubber gasket to help seal the closure plate. The closure plate can be duct-taped onto the flat smooth base of the tremie pipe as shown in Figure 9-10, or covered with a plastic wrap and tied to the tremie. Since the fluid pressure acts against the closure plate from the outside, the tape does not require great strength to hold the plate on to the tremie; in fact, excessive duct-

tape can make it difficult to break the plate off during concrete placement. The fluid pressure acting on the plate from the outside approaches  $\frac{1}{2}$  psi per foot of depth in the hole, so the plate must have sufficient strength to resist the hydrostatic head of the slurry. Other types of closure plates have been used, including a pan-type or “hat” device which fits like a cup over the outside of the tremie with an o-ring seal. Some contractors have even used a plate with a hinge system so that the closure plate remains attached to the tremie, although a projecting hinge has the potential to hang on the rebar cage as the tremie is lifted.

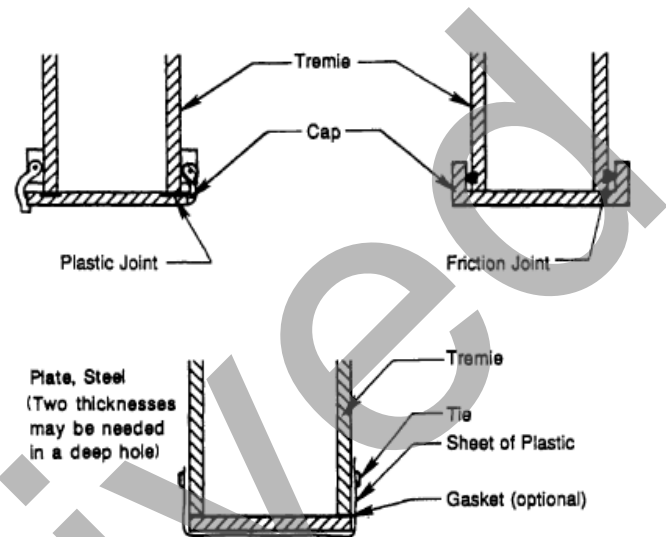


Figure 9-10 Closure Plates for Closed Tremie

Concrete placement with a closed tremie is started by first installing the tremie and placing the tremie to rest on the bottom of the shaft. The tremie is then filled with concrete and lifted to break away the closure plate and producing a surge of concrete when the tremie is first pulled upwards a small distance (about 6 to 12 inches). This “rush” of concrete occurs because the pressure due to the weight of concrete in the tremie is much greater than the fluid pressure at the base of the tremie. The inertia of the concrete forces its way under the fluid at the base of the excavation and pushes the drilling fluid out at the top. Note that this action may not be totally effective when the drilled shaft is on a batter, which is further reason to avoid batter shafts.

It is important that the closure plate release freely when lifting the tremie. There have been reported instances of difficulties in releasing the closure plate when the plate is heavily duct-taped to the bottom of the tremie. If the tremie is lifted more than a few inches above the base, there is a risk of excessive concrete falling through slurry.

With an open tremie, the open pipe is installed into the slurry or water and held a few inches from the bottom of the shaft excavation. Prior to introduction of concrete, a traveling plug commonly called a “pig” or “rabbit” is placed into the tremie pipe to act as a separator between the slurry and fluid concrete and to prevent mixing as the concrete travels down the tremie pipe. The plug may be constructed of polystyrene, closed cell foam or foam rubber which has been saturated with water. The plug should not be so compressible that it fails to perform its function as a separator within the tremie pipe under the anticipated hydrostatic pressure. However, an excessively long plug would require that the tremie be

lifted a considerable distance off the bottom in order for the plug to clear the tremie, and this lifting would allow concrete to fall through slurry or water and result in contaminated concrete.

The management of the tremie during the first few feet of concrete placement into the shaft with a tremie is a particularly important aspect of a successful operation. It is vital that concrete delivery be continuous during this period until a head of at least 10 ft of concrete is achieved in the drilled shaft above the tip of the tremie. The tremie must be kept within a few inches of the bottom of the shaft during this period so the flow of concrete out of the tremie is controlled and a head of concrete inside the tremie is developed and maintained, as illustrated in Figure 9-11. This control is especially important in a large diameter and deep shaft, where a large volume of concrete is required to fill the tremie and to fill the shaft excavation. If a limited initial charge of concrete is supplied and allowed to flow freely from the tremie, it is possible that the head of concrete may not be maintained within the tremie and a “back-surge” of water or slurry can enter the tremie thus resulting in a breach of the tremie seal into concrete. Subsequent delivery of concrete into the tremie would result in mixing of concrete with water or slurry and contamination of a substantial volume of concrete within the hole, as illustrated in Figure 9-12.

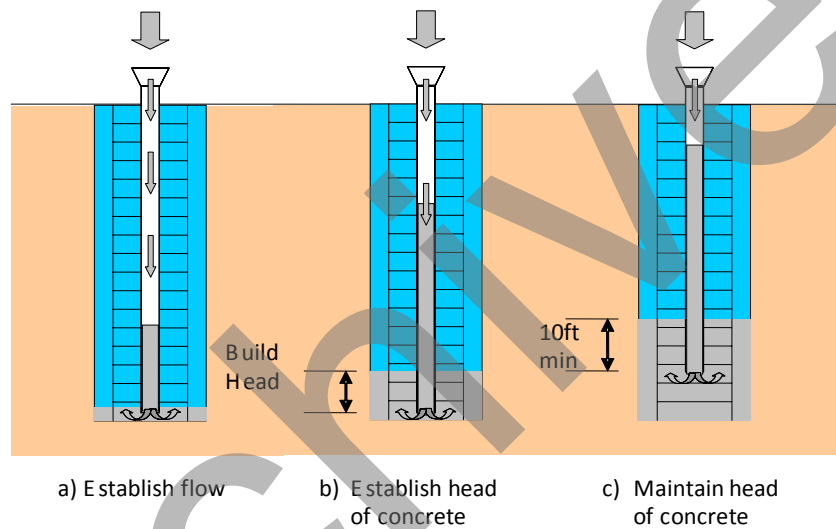


Figure 9-11 Control of Tremie to Establish Concrete Head

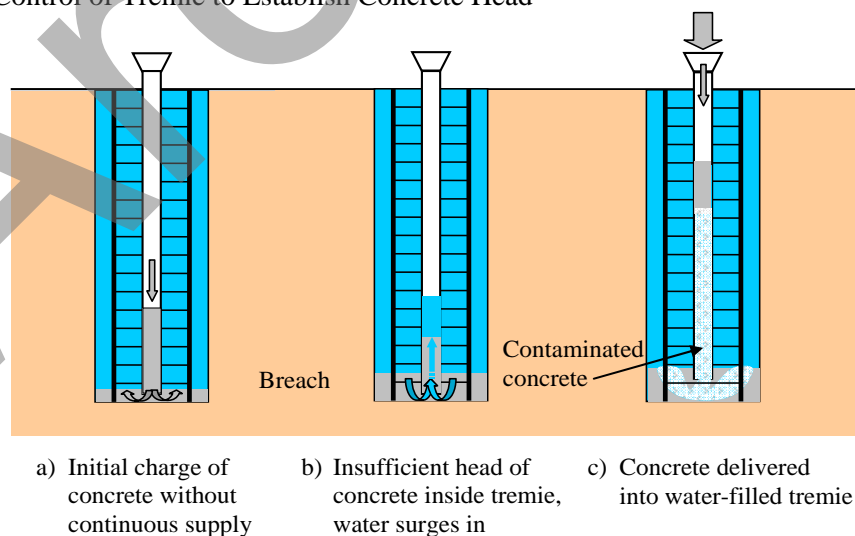


Figure 9-12 Breach of Tremie Due to Failure to Establish Concrete Head

During tremie placement of concrete it is recommended that the end of the tremie be embedded a minimum of 10 ft into the fresh concrete. As the column of concrete rises within the shaft, the tremie should be lifted as required to maintain flow. The contractor will need to use a segmental tremie or to provide the capability to lift the concrete to the top of an elevated solid tremie in order to lift the tremie during concrete placement. If the concrete has good workability and is flowing easily, it is often possible to maintain tremie embedment of 20 ft or more. However, excessive embedment of the tremie into the concrete can cause the reinforcing cage to start to lift along with the rising column of concrete.

If the concrete in the drilled shaft starts to lose workability, the concrete will not flow readily out of the pipe and will fill the tremie without emptying. Segregation of the mix within the tremie can also cause a blockage. If the workers are observed to shake the tremie from side to side or to “yo-yo” the tremie up and down, this action is usually in response to a problem with flow out of the tremie. Flow can sometimes be re-established by such action, but often the flow is a result of the concrete making a “vent” alongside the tremie pipe to the surface, and entrapment of laitance or sediment atop the concrete is likely. This phenomenon is illustrated in Figure 9-13. The long term solution to this problem is to adjust the mix characteristics (described subsequently in Section 9.6) so that workability is maintained for the duration of the placement operations.

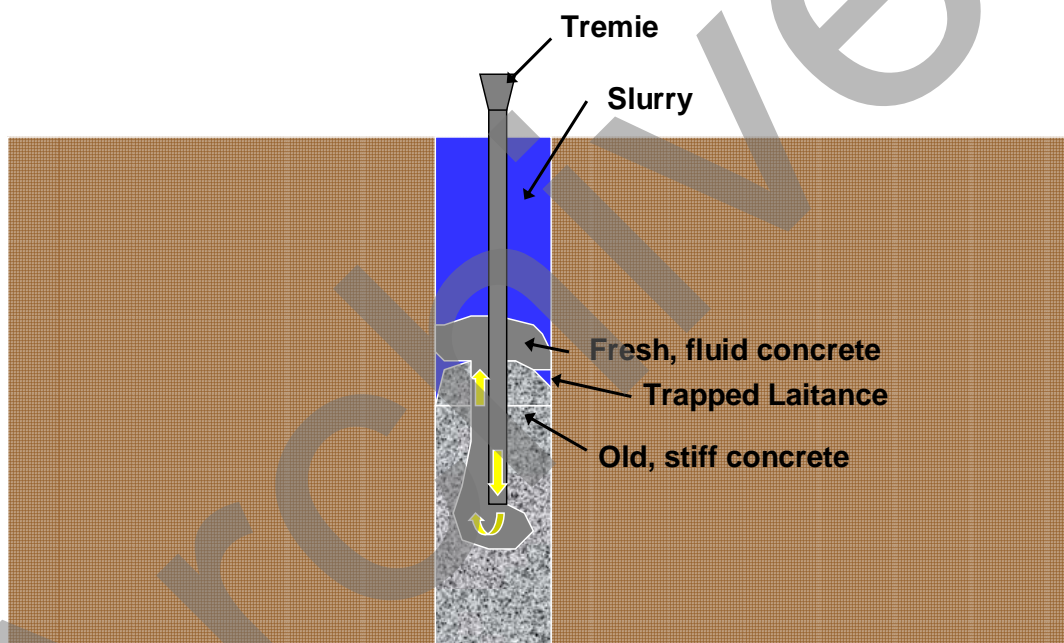


Figure 9-13 Schematic of Concrete “Vent” Due to Loss in Concrete Mix Workability During Tremie Placement

The photos in Figure 9-14 illustrate the effects of loss of workability in the mix during concrete placement. The photo in Figure 9-14a is from a drilled shaft which was constructed using a removable form, and the evidence of trapped laitance was the presence of pockets of weak, slightly cemented material on the surface of the drilled shaft. In an exposed location as shown (this column was in a lake), weak material near the surface could present durability problems and spalling of the concrete cover over the reinforcing. The photo in Figure 9-14b is from a drilled shaft which had an interruption in concrete delivery during placement; the delay resulted in a loss of workability in the old concrete. The defect was detected by integrity testing and subsequently repaired (see Chapters 20 and 21).

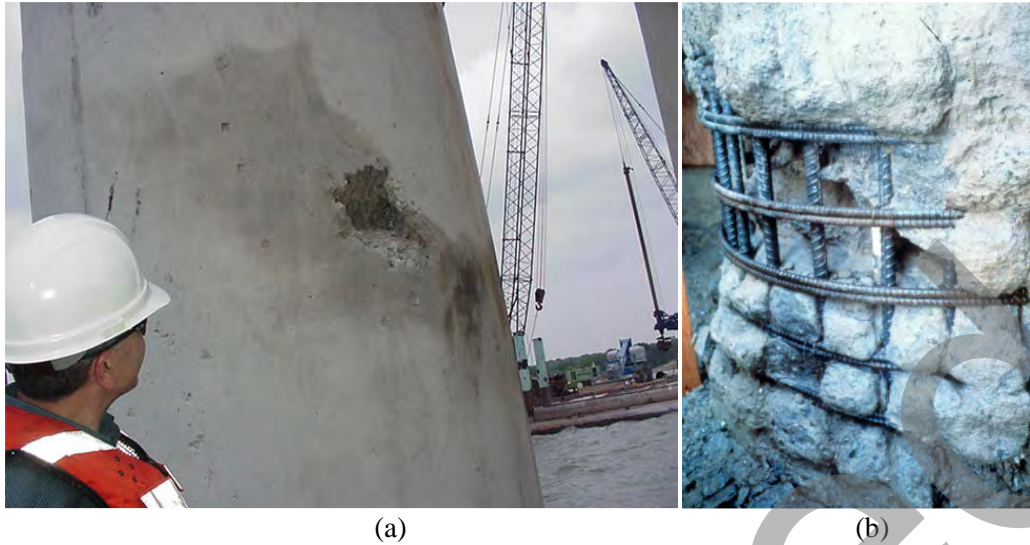


Figure 9-14 Effects of Loss in Concrete Mix Workability During Tremie Placement: (a) Trapped Laitance on Exposed Surface; (b) Effect of Interruption of Concrete Delivery

### 9.3.3.2 Placement by Pump

A concrete pump is often used to deliver the concrete from a convenient discharge location for the ready-mix trucks to the gravity-fed tremie. However, a closed pump tremie system may also be used in lieu of a gravity tremie for underwater placement of concrete into the shaft itself. The basic principles of underwater placement are identical to the tremie, only the delivery system is slightly different. The pump line in the shaft is typically a rigid steel pipe, 4 to 6 inches diameter, and connected to the delivery line via a short section of flexible hose, as shown in the photos of Figure 9-15. Clamp-type connectors include rubber seals to maintain a water-tight joint. Flexible lines within the shaft have been used on occasion, but it is more difficult to keep the line straight within the borehole. An advantage to the closed pump system shown is that the crane can lift the pump line system as needed without the need for a worker at the top of the tremie to direct the flow and manage the operation.

The general issues described previously relating to starting the concrete flow and developing a head of concrete with a gravity tremie also apply with a pumped closed tremie. Due to the relatively small diameter of the pump line, a lean cement mix or commercially supplied product is typically used to lubricate the line just prior to pumping concrete. Because the line must be held close to the bottom of the excavation and controlled during the initiation of concrete flow, rigid tremie pipes are preferred for pumped concrete operations. It is also essential that the pump be capable of delivering concrete in sufficient volume to keep up with the flow out of the line, or else the siphoning effect of the gravity flow of concrete down the line could lead to cavitation in the line and potential segregation of the mix (Gerwick, 1987).

The pumped tremie line should be maintained with a minimum 10 ft embedment as with a gravity tremie, but the line should be lifted as the column of concrete within the shaft rises. Even if the concrete is flowing, holding the line to the bottom of the shaft could lead to upward displacement of the reinforcing cage.



The concrete placed with a pump line system must have similar workability characteristics as would be used with gravity tremie placement. With a closed pump line system, one may be tempted to imagine that the pressure applied to the concrete delivered down the tremie would make it easier to maintain embedment of the tremie line into the fresh concrete during placement. However, if loss of concrete workability occurs as described in the preceding section, the pressure behind the pumpline will tend to make it push up and out of the concrete and the workers will find it difficult to hold the line down. In such cases, defects in concrete integrity could be expected; a closed pump tremie system is not a panacea for problems with a gravity tremie.

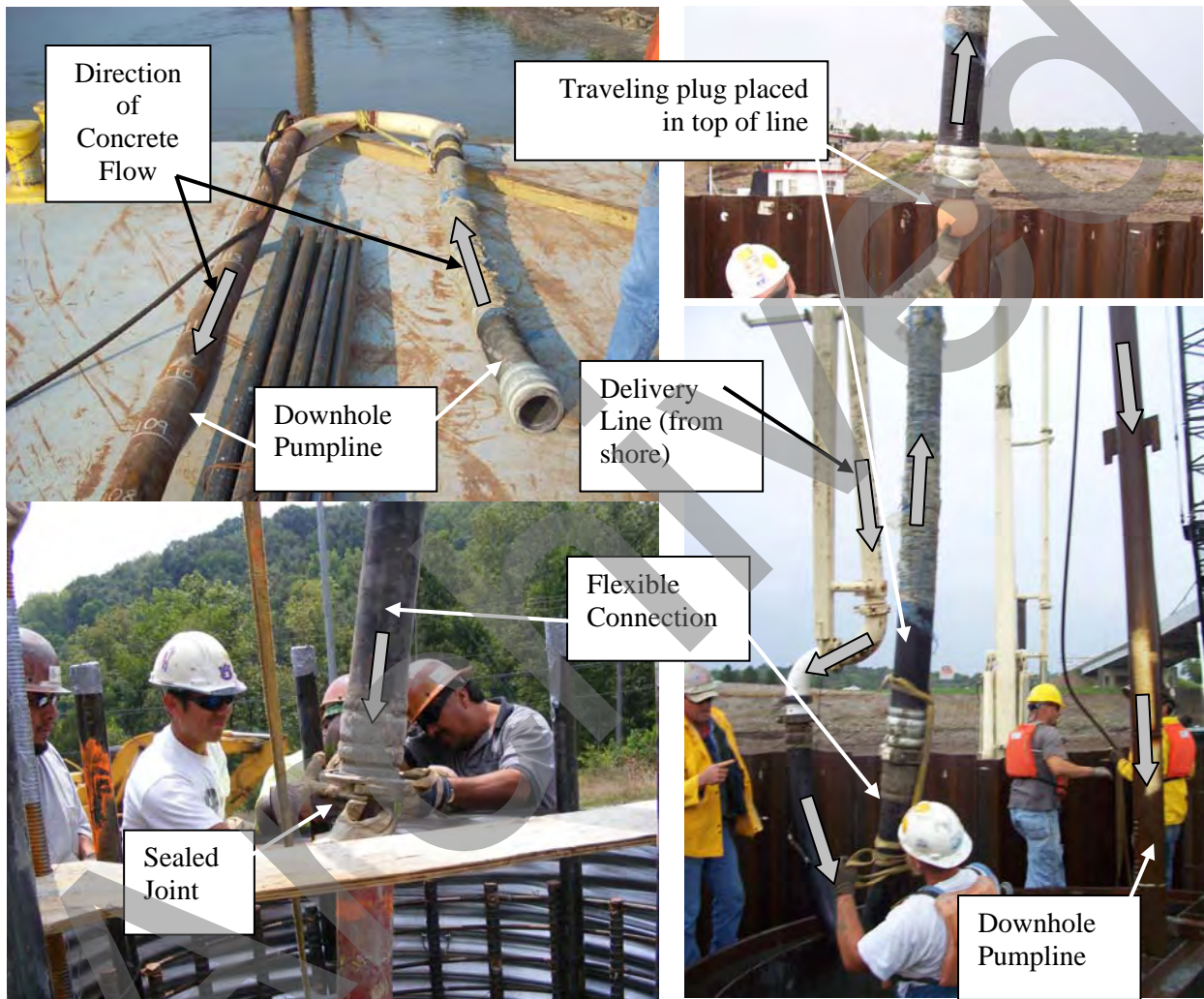


Figure 9-15 Pump Line Operations for Underwater Concrete Placement

### 9.3.3.3 Importance of Slurry Properties and Bottom Cleanliness

Even with excellent tremie operations and a properly designed concrete mix, there can be defects within the concrete if the hole is not clean or the slurry is heavily laden with sand. Even if the design of the drilled shaft does not rely on end bearing (such as a shaft used for a wall or controlled by lateral loading considerations), it is essential that the base of the shaft be reasonably free of loose debris which can be stirred up by the initial charge of concrete from the tremie. Such debris could find its way to the top of

the rising column of concrete only to be folded into the concrete as a trapped inclusion at some subsequent time part way through the concrete placement operation. In general, no more than 3 inches of loose sediment on the bottom of the shaft should be present prior to concrete placement in order to minimize the risk of soil inclusions; more restrictive bottom sediment requirements may be used for drilled shafts that rely wholly or partially on base resistance.

The drilled shaft in Figure 9-16 was an experimental shaft that was exhumed for examination. This shaft was cleaned using a cleanout bucket and airlift (as described in Chapter 5) and revealed good quality concrete across the majority of the bottom surface. The perimeter of the shaft base exhibited evidence of a small amount of debris, which tended to be displaced to the outside edge of the excavation by the concrete from the tremie.



Figure 9-16 Exposed Bottom Surface of an Exhumed Drilled Shaft

If sand settles out of suspension during the concrete placement operation, the accumulation of this debris atop the rising concrete column could result in entrapment of pockets of sand within the concrete. The slurry-filled hole is like a giant hydrometer test, with sand slowly settling to the bottom. If sand is observed atop the concrete at the completion of concrete placement, this signal should be a warning that the slurry was not sufficiently clean. The rising column of concrete does not rise as a static, horizontal surface. The surface of the concrete tends to roll from the center near the tremie toward the perimeter, and debris on the surface may tend to become lodged in pockets around the reinforcing and subsequently enveloped in the concrete.

For this reason, the sand content in the slurry immediately prior to concrete placement is an important property which must be controlled, as described in Chapter 7. Note that polymer slurry does not tend to keep sand or silt in suspension and therefore lower sand content must be specified. The sand content guidelines provided in Chapter 7 and in the guide specifications in Chapter 18 are for routine construction. It should be noted that deep and/or large diameter drilled shafts which take a longer time to complete the concrete placement may require that the sand content in the slurry be even lower than that of the typical specification. In large or deep shafts it may be necessary to fully exchange the entire volume of slurry. The shaft excavation is prepared by pumping the old dirty slurry from the bottom of the shaft to a tank or desanding unit, and simultaneously pumping fresh, clean slurry into the hole.

### 9.3.4 Records of Concrete Volume During Placement

During concrete placement, it is important to measure and maintain records of concrete volume placed as a function of elevation in the shaft. The top of concrete elevation during construction can typically be determined using a simple weighted tape. When compared to the theoretical volume required to fill the hole, these measurements can help to identify areas where overbreak may have occurred or where concrete may be filling voids such as solution cavities in karstic limestone formations. These measurements can identify an unusual condition in a production shaft where more investigation might be warranted; evidence of a cave-in during concrete placement would be indicated by a sudden rise in elevation in proportion to the incremental volume of concrete placed. It is particularly important that the volume be documented in a load test shaft so that variations between the test and production shaft are identified and evaluated. An example plot of measured and theoretical concrete volume versus depth is illustrated on Figure 9-17.

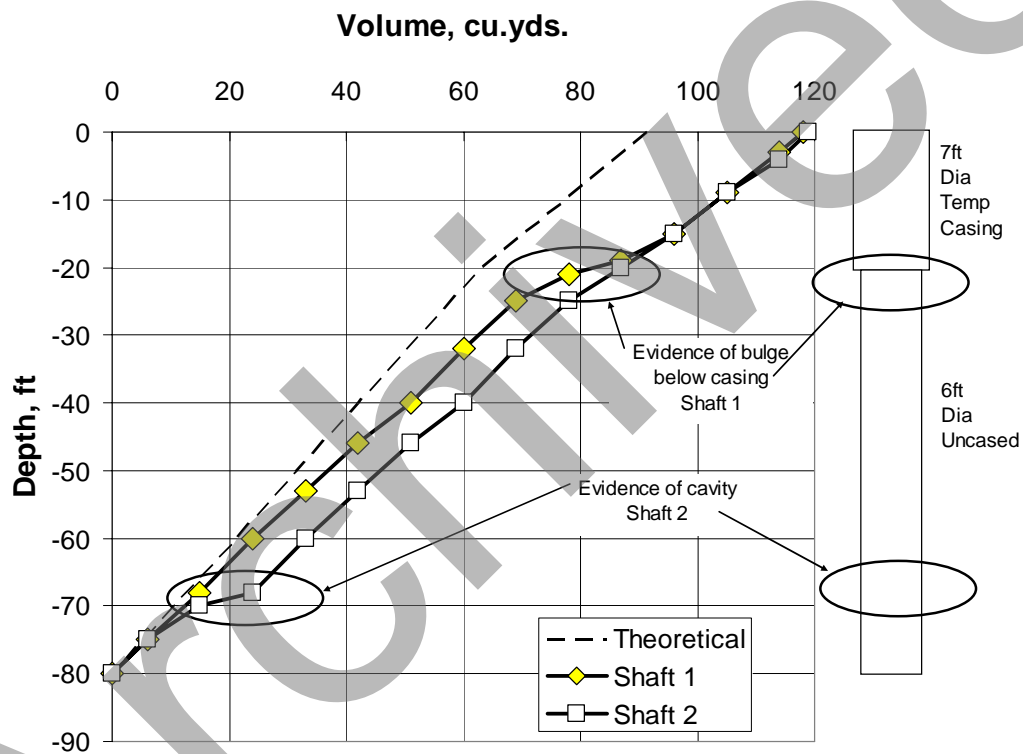


Figure 9-17 Example Concrete Volume Plots

It may be a challenge to obtain accurate measurements of concrete volume, particularly in a relatively small shaft. The most common method is to record the elevation of the concrete level in the shaft after each truck is discharged, with the volume determined by truck tickets. The volume of concrete within the tremie or pump lines must be estimated and subtracted from the total. In some cases a stroke counter on a pump may be used to estimate volume pumped, but the volume per stroke must be calibrated. If a bucket with known volume is used to place concrete, an approximate volume of concrete placed can be determined by bucket count.

More discussion of inspection of concrete placement is described in Chapter 19.

### 9.3.5 Completion of Concrete Placement at Shaft Head

At the completion of concrete placement using a tremie, there is often up to several feet of contaminated concrete which will need to be removed. Even with a dry excavation, there can be contamination at the top of the concrete due to accumulated bleed water. If the top of shaft is at or very near the ground surface, this concrete can readily be shoveled off by workers until clean fresh concrete is revealed. The constructor in the photo of Figure 9-18 over-poured the drilled shaft until clean concrete was present at the surface.



Figure 9-18 Over-pour of the Shaft Top Until Clean Concrete is Revealed

If the design includes a finished top of shaft elevation which is below grade, the completion of the shaft is more difficult. In most cases the constructor will prefer to over-pour the drilled shaft and remove slurry and contaminated concrete before it hardens. This operation will require a casing to be left in place if the top of shaft is more than a few feet below grade. In some cases with deep top of shaft cutoff, the constructor may be forced to remove contaminated material after the concrete hardens using jackhammers. Deep cutoff elevations (more than 20 ft) may require additional safety considerations for worker entry into the hole.

### 9.4 DRILLING NEAR A RECENTLY CONCRETED SHAFT

The guide specification provided in Chapter 18 includes a requirement that the concrete in a recently concreted shaft must achieve an initial set before drilling or casing installation can be done in the vicinity. The definition of "vicinity" in this specification is defined as a clear spacing of three shaft diameters. The most important reason for this specification is the possibility of communication between the nearby excavations, wherein the fluid pressure of the fresh concrete breaks through to the nearby excavation. In

a karstic region this concern can be particularly acute, and an increased separation distance may be needed. Vibro-driving of casing can also create elevated pore water pressures near fresh concrete which could lead to excessive bleed water or instability of the fluid concrete-filled shaft. There is little evidence of structural damage to the concrete due to normal drilled shaft construction operations.

Studies reported by Bastian (1970) indicate that nearby construction, such as drilling or pile installation, do not normally damage concrete within a recently-placed drilled shaft. He reports on a case where pile driving was being done 18 ft away from a shell-pile that had just been filled with fresh concrete. Three days after pouring the concrete, cores were taken. Subsequent testing showed that the compressive strength of the cores was slightly higher than that of concrete cylinders that were taken at the time of the casting of the concrete. Bastian reports on five other investigations by various agencies and groups. In each of the cases the results showed that the properties of fresh concrete were not adversely affected by vibration. Bastian reached the following conclusion: "There is ample evidence that the vibration of concrete during its initial setting period is not detrimental .... It can be concluded, therefore, that vibrations due to the driving of piles immediately adjacent to freshly placed concrete in steel pile shells is not harmful to the concrete and no minimum concreting radius should be established for this reason."

A typical concrete mix used for drilled shafts is expected to achieve a set within 24 hours. Exceptionally long placement times may require a mix with a high dosage of hydration control admixtures which could extend this normal limit. The 24-hour limit can sometimes be shortened by using silica fume or admixtures. Use of high-early-strength cement in the concrete mix is generally not recommended if shaft diameters exceed 5 ft because of the high heat of hydration. In general, the constructor must simply manage the construction sequence of closely-spaced drilled shafts to meet this requirement in the construction specifications.

## **9.5 BASE GROUTING**

Post-grouting of the base of the shaft is a strategy which can be used to enhance end bearing and compensate for a small amount of loose material on the bottom of the shaft excavation. Post grouting to enhance side shearing resistance is relatively uncommon in North American practice, and so this section will limit discussion to base grouting. The use and benefits of base grouting and design considerations are described in Section 4.5. The effect of base grouting on the axial resistance is described in Section 13.3.5.1. This section provides a brief description of the grouting apparatus and materials. Grouting requires expertise and experience that is not widely available and should normally be performed by a specialty subcontractor with demonstrated experience.

The grout is delivered to the base of the shaft via a system of tubes placed within the reinforcement. The principles and systems used for this purpose are described in Chapter 4 of this manual. Photos of two example systems for grout delivery tubes to the base of the shaft are provided in Figure 9-19. The system at left includes a series of sleeve port connections across the base of the shaft, with a cover plate to keep concrete away and allow the grout to distribute across the base. Another system shown at right, more commonly used outside the U.S., encapsulates the grout pipes at the base of the drilled shaft in concrete without a separation plate. With this system, water is injected in each grout circuit to fracture the concrete after it achieves its initial set, to facilitate grout injection at a later time. A layer of gravel, typically less than 18 inches thick, may also be placed at the base to enhance distribution; the gravel is normally placed into the shaft excavation before the cage and grouting system is lowered into place. The use of several separate circuits as shown provides redundancy in the system so that blockage of one tube does not preclude grouting using the others. A flat plate system with a neoprene cover has also been used, typically with some type of separator between the plate and the cover to facilitate communication between tubes.

The grout is normally a neat water-cement mixture with a water/cement ratio ranging from 0.40 to 0.55. Type I or II Portland cement is mixed with water in a colloidal mixer in order to fully mix the grout; paddle mixers should not be used. Typical grouting pressures range up to 800 psi and therefore the grout plant should be capable of higher pressures. High pressure lines and fittings to connect to the tubes within the shaft are required.



Figure 9-19 Sleeve Port Systems for Distribution of Grout to the Base of the Shaft

The grouting is typically performed after the concrete has achieved a compressive strength of at least 2500 psi. If integrity testing tubes are used for the grouting, the operation must be delayed until this testing is completed and reviewed. Base grouting can be delayed until a convenient time to grout several shafts, since the timing of the grouting operation is not critical from a technical standpoint.

The pressure grouting is performed by first flushing the lines with water until it returns to the top of the shaft to ensure communication through the tubes and verify that the grout has a flow path. Water is also used to pressurize the system and then initiate the break in the ports to ensure that outflow is achieved below the base of the drilled shaft. The grout is batched and pumped with the return lines open to purge the system of water and fully charge it with grout. When grout return is observed, the valves on the return line are closed to pressurize the system and the base of the shaft. Grout is pumped at a steady flow rate, and the volume and pressure recorded. Monitoring of the grouting operation should include the volume and pressure of grout delivered along with any upward movement of the drilled shaft. In some cases, strain gauges may be installed into the drilled shaft to monitor load in the shaft during grouting.

A criteria for grouting based on the pressure, volume, and shaft movement should be established by the designer. The performance target is normally based on achieving a minimum target pressure with a minimum grout volume, and with an upper limit on the upward movement of the top of shaft. The minimum grout volume is typically equal to the volume of an inch or two of shaft length beyond the volume required to fill the lines, plus the void space within the gravel bedding layer if one is used. This requirement is intended to ensure that grout is distributed across the base. Upward movement of the shaft can be a limiting factor on grout pressure; if the drilled shaft has inadequate side resistance and is jacked out of the ground, the target pressure may be unachievable. If a large volume of grout is placed (typically more than the volume of about two feet of shaft length), it may be an indication that the ground has hydraulically fractured under the grout pressure and the target pressure may not be achieved. In the latter

case, it is often possible to flush the lines with water before the grout has set, and perform another “stage” of grouting after the grout from the initial stage has set (usually less than one day).

## 9.6 CONCRETE MIX DESIGN

The concrete mix must achieve the required properties needed to allow the constructor to build a completed shaft that meets the structural requirements for the project and with a minimum risk of construction problems. The most important properties of concrete for drilled shaft construction were described in Section 9.2.

Note that the most important properties for drilled shaft concrete are those associated with the fresh properties of the concrete and the impact on construction operations. This issue is illustrated in Figure 9-20 which shows a drilled shaft with a concrete mix that did not adequately flow through the rebar cage. The technical demands on the hardened properties of concrete are usually not very severe, as the structural stresses in the concrete are typically relatively modest compared with many civil engineering works. Compressive strength requirements of 4,000 to 5,000 psi are typical and are easily achieved with modern materials. There have been a few isolated cases where higher strength concrete has been utilized (mostly for high rise buildings).

The sections which follow describe the components and procedures used to develop a concrete mix design that is suitable for drilled shaft construction.



Figure 9-20 Good Passing Ability is Required to Flow through Reinforcement

### 9.6.1 Cementitious Materials

#### 9.6.1.1 Portland Cement

Normally, Type I or Type I/II Portland cement is used for the design of concrete for drilled shafts. Type III, high-early-strength, cement should usually be avoided, especially in shafts with diameters greater than 5 ft. Large diameter shafts may lead to high in-place temperatures and large thermal gradients which may adversely affect the long-term performance of the shaft; in these instances cementitious materials systems with low heat of hydration potential are preferred. The Portland cement should meet the requirements of

ASTM C 150 (2007). Special sulfate-resisting cements should be considered in environments where the sulfate content of the soil or groundwater is extremely high. Type II and V Portland cement can be used when improved sulfate resistance is desired as the maximum amount of tricalcium aluminate ( $C_3A$ ) in these cements is limited. However, the availability of Type V may be limited, and increased sulfate resistance can be obtained by using supplementary cementing materials (SCMs) in combination with the appropriate selection of a sufficiently low water-to-cementitious materials ratio (w/cm).

### 9.6.1.2 Supplementary Cementing Material

The addition of supplementary cementing materials (SCMs) to ordinary Portland cement may improve the durability and the strength of drilled shaft concrete. SCMs such as fly ash, slag cement, and silica fume are by-products from other industries and they are commonly used in the concrete industry. Class F fly ash (ASTM C 618, 2005) and silica fume are pozzolanic materials that themselves possess very little strength when hydrated by water, but in the presence of Portland cement, particularly the free calcium hydroxide (lime) that exists in Portland cement, they form cementing materials. Class C fly ash (ASTM C 618, 2005) is typically high in calcium oxide content ( $CaO > 20\%$ ) and exhibits both hydraulic (similar to Portland cement) and pozzolanic behavior. Because of this characteristic, the rate of strength development of concrete mixtures made with Class C fly ash is typically more rapid than concrete made with Class F fly ash. Both Class F and C fly ash are commonly used in the concrete industry; however, their local availability is determined by the nature of the coal burned in nearby power plants. Class F fly ash may contain some unburned carbon (as shown by high loss on ignition (LOI) values) that will cause difficulties in consistently entraining sufficient amounts of air to obtain concrete that is resistant to cycles of freezing and thawing.

Slag cement (formerly known as ground-granulated blast-furnace slag) (ASTM C 989, 2005) is a by-product from the production of iron. Slag cement is commonly used to replace between 30 to 50 percent of Portland cement by weight. Unlike fly ash, which can be used directly after collection from the stack of a power plant, slag cement must be ground to the desired fineness before it can be used as a cementitious material. In the United States, slag cement is specified according to ASTM C 989, which provides for three grades of slag cement depending on its reactivity index. The reactivity index provides a measure of the relative 28-day mortar strength obtained from a 50%-50% slag cement-cement blend relative to the strength of pure Portland cement mortar. The classifications are Grades 80, 100, and 120, and the higher the grade the higher the reactivity index of the slag cement. Slag cement is a latent-hydraulic material that in the presence of hydroxyl ions reacts similar to Portland cement. The slag cement particles are usually ground to size that is slightly finer than Type I Portland cement. The hydration of slag cement is more sensitive to curing temperature than Portland cement. Under cold weather conditions the rate of hydration of slag cement will be significantly retarded and extended setting times may result.

When large dosages of fly ash or slag cement are used, the strength development will be slower when compared to mixtures with only Portland cement. However, when cured, these mixtures may exhibit higher long-term strengths. In these cases it is advisable to test the specified compressive strength at 56 or 91 days in lieu of the normal age of 28 days that is usually specified for conventional concrete. Mixtures that contain combinations of fly ash and slag cement have successfully been used.

Silica fume consists of very fine particles (100 times finer than Portland cement) and because of its high surface area it significantly increases the water demand of the mixture, which necessitates the use of a high-range water reducing admixture to obtain the desired degree of workability. The high surface area of silica fume ensures that it reacts at early stages and it typically contributes to increase early-age and long-term strengths, and to decrease long-term permeability (ACI 234R, 2000). Silica fume, which is rich



in silicon dioxide, combines with the excess lime in the Portland cement and produces a cement paste that is usually stronger and denser than that produced by using either Portland cement alone or by using other SCMs; however, silica fume is relatively expensive compared to fly ash or slag cement.

Fly ash and silica fume generally reduce the amount of bleeding experienced by the concrete. Bleeding can be bothersome if bleed water escapes through channels in the concrete or at the interfaces between concrete and rebar. Fly ash, silica fume and slag cement will have an effect on the rate of strength and stiffness development in drilled shaft concrete. The rate of strength development will often be slower when fly ash or slag cement are added than with concretes made with Portland cement alone. Silica fume, however, may act to increase the rate of strength gain in the first month after setting.

The advantage of using these SCMs in Portland cement concrete is that over time they convert calcium hydroxide to calcium silicate hydrate, which is the most dense and desirable hydration product produced when Portland cement hydrates. The formation of increased amounts of calcium silicate hydrate densifies the pores in the concrete, which will lead to increase long-term strength, reduced long-term permeability, and a general improvement in long-term durability that will be described later.

The SCMs discussed in this section may produce other desirable effects in drilled shaft concrete. Fly ash and slag cement tend to reduce the heat of hydration, so that its use is recommended in large-diameter shafts (diameter  $\geq 5$  ft). The effect of using SCMs in a 6-ft diameter shaft was evaluated by the ConcreteWorks software (Folliard et al, 2008) and the results are shown in Figure 9-21. The results in Figure 9-21 will vary depending on placement conditions, soil conditions, chemistry of cement and SCMs, etc. The results in Figure 9-21 indicate that the use of fly ash and slag will lower the maximum in-place temperature reached when compared to the use of only plain Portland cement mixtures.

SCMs tend to retard the set of the cement paste, thereby increasing the time that the concrete remains workable. Because of its spherical particles, the use of fly ash to replace Portland cement will reduce the water demand of the mixture. Because of its increased fineness and angular particle shape, the use of slag cement will tend to increase the water demand. Typical ranges of pozzolanic additives are described in the section on mixture proportions.

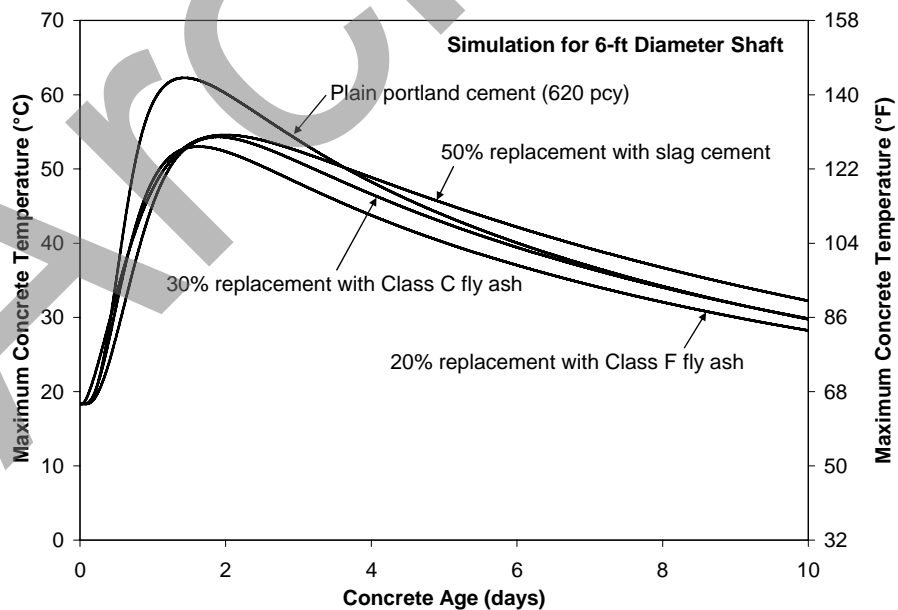


Figure 9-21 Simulated Effects of using SCMs on the Maximum Concrete Temperature Reached

## 9.6.2 Chemical Admixtures

The use of chemical admixtures for drilled shaft concrete is discussed in this section. Typical ranges of concrete admixtures (except for accelerators, which are not ordinarily used in drilled shafts) are described in the following section on mixture proportions; however, chemical admixture companies should be consulted to determine the most suitable admixture type and dosage for a given project, materials, and placement conditions.

The successful use of chemical admixtures depends on the methods of preparation and batching. Most chemical admixtures are furnished in a ready-to-use liquid form. Dispensing of the admixtures must be carefully controlled and routinely inspected to ensure that the approved correct amount is added to each batch; the improper dispensing of any chemical admixture could lead to erratic and often undesirable behavior of the drilled shaft concrete. The reader is referred to Section 1.7 ACI 212.3R (2004) for more information on the preparation and batching of chemical admixtures. Admixtures are covered by various ACI and ASTM specifications, some of which are described individually below.

### 9.6.2.1 Air-entraining Admixtures

Air-entraining admixtures are used to introduce and stabilize entrained air bubbles in concrete. Air-entraining admixtures (ASTM C 260, 2001) can be used in drilled shaft concrete when deterioration of the concrete by freeze-thaw action is possible (e.g., where the top of the shaft is above the depth of frost penetration). Entrained air will also improve workability and pumpability, and reduce bleeding; however, it increases the porosity of the concrete which will reduce the strength (ACI 212.3R, 2004). When air is added to improve the mixture's pumpability, then about 5% is needed for this purpose.

### 9.6.2.2 Set-Controlling Admixtures

Set-controlling admixtures (also known as retarding or hydration stabilizing admixtures) are often required to improve the concrete's rate of workability loss. These admixtures are frequently used in large placements and when the concrete is placed during periods of high temperatures ( $> 80^{\circ}\text{F}$ ) in order to reduce the slump loss over periods during which the concrete is being placed in the drilled shaft. This is primarily to provide the contractor with an adequate period of time to work with temporary casing and tremie-placed concrete. A general rule is that this period should be two hours more than the time estimated by the drilled shaft contractor to finish concrete placement and, if necessary, to remove the temporary casing. When estimating the duration of construction, the contractor should allow some additional time for unforeseen delays. While it is important to retard the set of concrete in many field settings, the use of excessive retarders can keep the concrete fluid for too long and can affect its long-term strength. Retarders (ASTM C 494, 2005) consist of lignin, borax, sugars, tartaric acids and salts.

Hydration stabilizing admixtures (also known as extended-set control admixtures) are relatively new to the concrete industry and act to stabilize the hydration of the Portland cement, delaying it from reaching initial set. Once the effect of the admixture wears off, hydration of the cement will resume without sacrificing any of the hardened properties of the concrete. In many cases, these hydration stabilizing admixtures are more effective in controlling the time of set of drilled shaft concrete than conventional retarding admixtures. These admixtures have successfully been used on many drilled shaft projects. Most major chemical admixture supply companies have hydration stabilizing admixtures, and they are classified as a Type D Retarder by ASTM C 494 (2005).

It is very important that the dosage of set-control admixture be established based on the ambient temperature conditions and concrete temperature expected at placement. The haul time (including some allowance for traffic delays) from the concrete plant to the construction site should be estimated and used to determine the most suitable admixture type and dosage. Higher dosages of set-control admixture will be required under warm weather placement conditions. The required dosage of admixture should be determined by trial placements where the conditions expected during construction are replicated, and a sample of concrete is retained and tested to determine its workability retention characteristics.

### 9.6.2.3 Accelerating Admixtures

An accelerating admixture is “an admixture that causes an increase in the rate of hydration of the hydraulic cement and thus shortens the time of setting, increases the rate of strength development, or both” (ACI 116R, 2005). Accelerating admixtures have a place in some instances in substructure and superstructure construction, but they should not be used in drilled shaft construction except in extraordinary situations (e. g., possibly when a segment of a drilled shaft is being placed in a stratum of granular soil having rapidly flowing groundwater, when a casing cannot be used to seal off the stratum, in order to minimize washout of the cement). Concrete specialists should be consulted whenever the use of accelerators is contemplated, and the contractor will need to be very attentive to cleaning casings, pumps, pump lines and tremie pipes quickly, before setting occurs.

### 9.6.2.4 Water Reducing Admixtures

Water-reducing admixtures reduce the water requirements of a concrete mixture for a given slump. Water reducers reduce the surface tension of the water surrounding the cement particles before the concrete begins to set, thereby increasing the workability (slump) of the fluid concrete without the need for excessive water. Three main types of water reducing admixtures are commonly used and are classified in accordance with ASTM C 494 (2005):

- Low-range water reducing admixture (a.k.a. water reducers): Typical water reduction is around 5% to 10%.
- Mid-range water reducing admixture: Typical water reduction is from 6 to 12%.
- High-range water reducing admixture (a.k.a. superplasticizers): A water reduction from 12% to 30% can be achieved.

In order to achieve the high values of slump that are desirable for drilled shaft construction without water reducers, the water/cementitious material ratios ( $w/cm$ ) need to be in the range of 0.50 - 0.60 (by weight). (In this context, "cementitious materials" are considered to be the Portland cement and other cementing materials such as fly ash or slag cement that are made part of the cement paste.) More than half of the water in such a mixture is present only for lubrication of the cement paste during concrete placement and is not needed for cement hydration. The excess water produces a hydrated cement paste that contains many pores, which results in a permeable, weak concrete. With water reducers, the  $w/cm$  can be reduced conveniently to 0.45 or lower, which helps produce a denser and less permeable paste while at the same time providing excellent fluidity. Both low-range and high-range water reducers have been used in drilled shaft concrete. With high-range water reducing (HRWR) admixture (also known as "superplasticizers"),  $w/cm$  can be reduced to 0.35 or less while maintaining a high slump. Low-range water reducers can be used to obtain workable concrete with a  $w/cm$  in the range of 0.40 to 0.45. LRWR's can consist of lignosulfonates, hydroxylated carboxylic acids, etc. (ACI 212, 2004).

First (naphthalene-based) and second (melamine-based) generations of superplasticizers often experienced rapid loss of consistency or slump, which is very undesirable in large placements. The third generation of superplasticizers is synthetic materials often called polycarboxylates and these are designed to be compatible with regional cements. Polycarboxylate-based superplasticizers in combination with set-controlling admixtures have the ability to maintain their level of water-reduction even under hot weather conditions. Although the lower  $w/cm$  obtainable with the HRWR will result in a more durable and stronger concrete, the use of inappropriate HRWR admixtures can, on occasion, cause rapid setting, which can be very detrimental to the drilled shaft construction process, since the contractor needs to have some warning that the concrete is beginning to set if unexpected delays are occurring.

Highly fluid concrete with a slow-rate of slump loss is preferred to highly fluid concrete that has a very low value of  $w/cm$  but that also has the potential for undergoing very rapid set, even though the final product may not be quite as strong or durable. HRWR admixtures should not necessarily be disallowed, but if their use is contemplated on a job, the slump loss characteristics of the concrete mixture that is to be used on the job, and that is made with the exact high-range product that is to be used on the job, should be measured at the ambient temperature at which the concrete is to be placed in order to verify that the admixture does not produce undesirable slump loss effects. A plan for management of HRWR admixture concrete should also be required of the contractor as part of the construction specifications (e.g., TxDOT, 2004)

#### **9.6.2.5 Other Admixtures**

Viscosity-modifying admixtures (VMAs) (also known as anti-washout) are often used with mixtures that are designed to be self-consolidating as they may reduce segregation and bleeding in these types of concretes. VMAs also improve the effectiveness of self-consolidating concrete mixtures as they bind some of the free water that may affect concrete workability. VMAs are typically formulated from cellulose ether, whelan gum or polyethelene glycol, and they work simply by binding excess water in the concrete mixture, thereby increasing the cohesiveness and viscosity of the concrete. VMAs can be effective at binding up free water prior to setting of the concrete, which will help to minimize bleeding of the mixture. VMAs also help to reduce the variability of the fresh properties of self-consolidating concrete mixtures that can arise from variations in free water and placement conditions

Other types of chemical admixtures for drilled shaft concrete mixtures are available for special cases. Examples of these are anti-bacterial and anti-fungal admixtures, alkali-reactivity reducers, corrosion inhibitors, and pumping aids. Except for pumping aids, which are normally polymer products added to the concrete prior to pumping to aid in lubricating the pump lines, these are rarely used in drilled shaft construction. However, the reader should be aware of their existence.

#### **9.6.3 Aggregate and Water**

Besides the cementitious materials and admixtures, the materials used in the concrete consist of the aggregates and mixing water. Natural materials are normally used as aggregates for drilled shaft concrete. Lightweight aggregates are not ordinarily recommended and there are no benefits to using this type of aggregate in drilled shafts. It is recognized that natural aggregates (natural gravel, sand and crushed stone) that are used for drilled shaft concrete in the United States are typically stronger and less permeable than the hydrated cement paste in the hardened concrete. For this reason, conventional wisdom states that the largest aggregate must be as large as possible and that the aggregate should be

well-graded in order to minimize the amount of paste in the mix. However, for economical construction, the concrete should be designed so that it can fall freely through some distance if it is to be placed in the dry (dry or casing methods) and should be able to flow freely through the rebar in the cage.

The aggregate size has a significant effect on the passing ability of the concrete through the reinforcement cage, as discussed in Chapter 8. For these reasons, relatively small aggregate on the coarse end of the spectrum should be used. A nominal maximum size of 3/4 inch has performed well in routine applications without congested reinforcement and in dry placement operations. Smaller sizes should be considered in drilled shafts where the clear spacing between reinforcing bars is restricted and/or tremie placement under fluid is anticipated. The use of a nominal maximum size of 1/2 inch has successfully been used in congested applications (Brown et al, 2007). Many agencies now routinely use 3/8 inch nominal maximum aggregate size for drilled shaft concrete because of congested reinforcement and tremie placement operations. The aspect ratio can be a consideration for crushed aggregates, because oblong shaped pieces do not flow as well as more nearly spherical particles.

Good gradation down to smaller sizes is an important characteristic. All aggregate should be checked to see that the appropriate specifications are met. Some of the relevant specifications of the American Society for Testing and Materials for concrete aggregate are ASTM C 33 (2003), Specification for Concrete Aggregate; ASTM C 87 (2005), Test for Effect of Organic Impurities in Fine Aggregate on Strength of Mortar; and ASTM C 227 (2003), ASTM C 289 (2003), ASTM C 295 (2003), and ASTM C 586 (2005), all of which address tests that measure the alkali susceptibility of aggregates. As an example of the importance of testing the aggregates that are used in concrete, there are aggregates in existence that can expand when exposed to Portland cement, which has a very high pH value (above 12) and is therefore very alkaline. The local agency's specification requirements that guard against alkali-silica reaction should be followed.

The concrete prism test (ASTM C 1293, 2005) is generally accepted to be the most appropriate test method for predicting field performance of ASR in concrete. However, the downside of this test is that it requires 1 year for testing aggregates and 2 years for testing SCMs (Folliard et al, 2006). The accelerated mortar bar test (ASTM C 1260, 2005) provides a result in 14 days and in most cases can be used to as screening tool to identify aggregates that are not susceptible to ASR (Folliard et al, 2006). Aggregates tested by ASTM C 1260 that do not pass the 14-day expansion limit of 0.10 percent may not be reactive and testing by ASTM C 1293 should then be pursued to evaluate the susceptibility of this aggregate to ASR. The following are some options provided by the Texas Department of Transportation (TxDOT, 2004) to prevent ASR in new construction:

- Replace 20 to 35% of the Portland cement with Class F fly ash
- Replace 35 to 50% of the Portland cement with slag cement
- Replace 35 to 50% of the Portland cement with a combination of Class F fly ash, slag cement, or silica fume. However, no more than 35% may be fly ash, and no more than 10% may be silica fume.
- Use blended hydraulic cements (ASTM C595) such as Type IP (contains pozzolans other than Portland cement) or Type IS cement (contains slag cement). Up to 10% of a Type IP or Type IS cement may be replaced with Class F fly ash, slag cement, or silica fume.
- Replace 35 to 50% of the Portland cement with a combination of Class C fly ash and at least 6% of silica fume. However, no more than 35% may be Class C fly ash, and no more than 10% may be silica fume.
- Use a lithium nitrate admixture at a minimum dosage of 0.55 gal. of 30% lithium nitrate solution per pound of alkalis present in the hydraulic cement.

- When using hydraulic cement only, ensure that the total alkali contribution from the cement in the concrete does not exceed 4.00 lb. per cubic yard of concrete when calculated as follows:

$$\text{lb. alkali per yd}^3 = \frac{(\text{lb. cement per yd}^3) \times (\% \text{Na}_2\text{O equivalent in cement})}{100}$$

In the above calculation, use the maximum cement alkali content reported on the cement mill certificate.

- As alternative to the bulleted options listed above, the following testing may be performed on a project-specific basis:
  - Test both coarse and fine aggregate separately in accordance with ASTM C 1260, using 440 g of the proposed cementitious material in the same proportions of hydraulic cement to supplementary cementing material to be used in the mixture.
  - Before use of the mixture, provide the certified test report signed and sealed by a licensed professional engineer demonstrating that the ASTM C 1260 test result for each aggregate does not exceed 0.10% expansion.

Water used for mixing the concrete need not be potable (free of organic contamination and deleterious materials); however, almost any natural water that is drinkable can be used as mixing water for making concrete (Kosmatka et al, 2002). Water for concrete should have low chloride and sulfate contents. Questionable water can be assessed by comparing the effect of its use on setting times and 7-day compressive strength (Kosmatka et al, 2002), although these tests would not address questions related to long term effects such as durability.

## 9.6.4 Workability

One of the most important characteristics of concrete to be placed by tremie or by pumping is high workability; this characteristic is essential because, as noted previously, the concrete must self-consolidate and have sufficient passing ability to flow through the reinforcing cage without the use of vibration. In addition, it is critical in tremie placement applications that the concrete must remain workable until the entire placement operation is complete and any temporary casing removed from the excavation.

### 9.6.4.1 Conventional Drilled-Shaft Concrete

A number of methods are available for measuring the workability of concrete, but the slump test is used almost exclusively in practice for conventional concrete mixtures. Concrete for drilled shafts should have a slump of 6 inches or higher when the dry method is used and about 9 inches when the wet or casing methods are used. The slump test is not an ideal method for measuring the workability of a mixture; however, no other test is generally accepted for field use.

High workability is best achieved with rounded natural aggregate and natural sand. However, crushed stone is being used more and more as rounded natural aggregate supplies are being depleted. Crushed stone mixtures will require either higher paste contents or increased dosages of water-reducing admixture to attain a degree of workability comparable to mixtures made with rounded aggregate. If crushed stone is used as the aggregate, care must be taken to wash away all of the dust, because the dust can use up water that is ordinarily available for lubrication and hydration of the concrete mixture.

#### 9.6.4.2 Recent Advances in the Development of Self-Consolidating Concrete

ACI Committee 237 (2005) defines self-consolidating concrete (SCC) as “highly flowable, nonsegregating concrete that can spread into place, fill the formwork, and encapsulate the reinforcement without any mechanical consolidation.” Actually, conventional drilled shaft concrete must meet these characteristics; however, SCC mixes typically provide greater workability than conventional drilled shaft concrete. SCC is not routinely used for drilled shaft construction in North America; however, due to its high flowability and passing ability, SCC has been successfully used in some projects in the United States. Some recent projects are listed as follows, which include 6 to 8 ft diameter shafts up to 120 ft deep:

- Lumber River bridge near Myrtle Beach, South Carolina (Brown et al, 2007),
- I-35W St. Anthony Falls Bridge in Minneapolis, MN (MacDonald, 2008),
- Mullica River Bridge on the New Jersey Turnpike,
- B.B. Comer Bridge over the Tennessee River in Scottsboro, Alabama.

The high slump concrete normally used for drilled shaft construction that has traditionally been placed was developed from conventional concrete with the additional fluidity obtained by adding some combination of water and/or high-range water reducing (HRWR) admixtures. In a sense, drilled shaft concrete has traditionally been depended upon to “self-consolidate”, since no vibration is used as an aid to placement. However, the term SCC is generally used with concrete mixtures designed to flow with much greater workability than is commonly specified for conventional drilled shaft concrete.

The flowability of SCC mixtures is assessed based on a measurement of *slump flow* (ASTM C 1611, 2005) rather than slump. Slump flow is determined by placing the mixture within a conventional slump cone (without rodding) on a nonabsorbent surface, then withdrawing the slump cone and measuring the diameter of the resulting concrete “patty” (ASTM C 1611, 2005). The slump flow test is used to assess the filling ability of SCC in the absence of obstructions. It is recommended to use the slump cone in the inverted position for all slump flow testing. The degree of segregation of the SCC can also be assessed by assigning a visual stability index (VSI) to the concrete patty. The VSI is a numerical rating from 0 (no segregation) to 3 (clearly segregated), in increments of 0.5, based on the homogeneity of the mixture after the slump flow test has been conducted (ASTM C 1611, 2005). A VSI of 1.5 or less should be used for SCC designed for drilled shaft construction. The passing ability of SCC can also be assessed by the J-Ring test (ASTM C 1621, 2006); however, the clear spacing between the vertical dowel of this test is only 1.735 inches, which is too close to be representative of drilled shaft conditions.

Hodgson et al. (2005) concluded that when SCC is used in drilled shaft applications, a slump flow of approximately 24 inches should provide sufficient workability while showing limited signs of segregation. Note that the higher the target slump flow, the greater the need for precautions to prevent segregation of the mixture. Precautions might include greater attention to quality control and/or the addition of viscosity modifying admixtures. Additionally, a minimum slump flow of 18 inches will provide an increase in workability compared to conventional drilled shaft concrete and it should displace the drilling slurry upward in a uniform motion. In the successful trial drilled shaft projects cited above, a slump flow has generally been maintained in the range of 18 to 24 inches.

SCC mixtures developed specifically for drilled shaft construction utilizes a higher sand-to-total aggregate ratio and an increased cementitious materials content than conventional drilled shaft mixtures. Typically, even though SCC mixtures may have higher total cementitious material content, the Portland cement content may be low compared to conventional mixes due to the use of large dosages of SCMs. The reduced Portland cement content and the use of a supplementary cementitious material such as Class F fly ash will help delay setting and reduce the maximum in-place concrete temperatures (Schindler and

Folliard, 2005). The increased fines content and the use of a viscosity modifying admixture (VMA) produce a SCC mixture with high flowability, increased stability (reduced likelihood of segregation of the coarse aggregates), and reduced bleeding (Bailey et al, 2005). SCC mixtures can be proportioned to achieve similar strength properties to that of conventional drilled shaft concrete.

### 9.6.5 Control of Concrete Temperatures

Control of temperature is very important for drilled shaft concrete in order to control setting time and the heat of hydration. Excessive concrete placement temperatures will accelerate the rate of hydration significantly and reduce the concrete's workability. This effect is nonlinear and rate of hydration increases dramatically with temperature in excess of 70°F. The measurements presented in Figure 9-22 demonstrate the effect of initial temperature on the heat generated within the concrete as a function of time. This generated heat produces more rapid setting in the mixture and a significantly higher heat of hydration in large diameter drilled shafts.

Besides the concern about setting time, high heat of hydration is a potential concern for drilled shaft concrete. Shafts larger than about 5 ft diameter have characteristics of mass concrete in which the heat of hydration can feed on itself and generate large temperatures within the shaft. Recent measurements in Florida (Mullins, 2006) have shown temperatures within the interior of 10 ft diameter shafts as high as 180°F. Concrete members made with plain Portland cement that reach temperatures above 158°F may exhibit delayed ettringite formation (DEF) (Taylor et al, 2001). DEF causes internal expansion in the cement paste and initially results in microcracking that in some instances may progress to severe cracking in the concrete. The use of sufficient amounts of fly ash or slag cement will help mitigate DEF, and in this case concrete temperatures up to about 170°F can be tolerated without significant concerns of DEF (Folliard et al., 2006). Guidelines for sufficient amounts of SCMs to mitigate against DEF include at least 25% Class F fly ash, at least 35% Class C fly ash, or at least 35% slag cement.

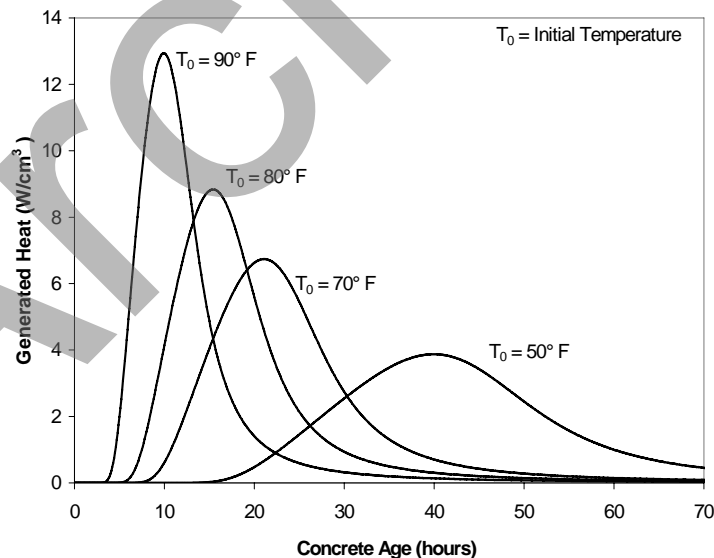


Figure 9-22 The Effect of Different Initial Mixture Temperatures on the Temperature Development (shown in Watts/cm<sup>3</sup>) During Adiabatic Conditions (Schindler, 2002)



The temperature development of an in-place mixture within an actual drilled shaft can be evaluated on test specimens by using adiabatic (no heat is gained or lost by the system) or semi-adiabatic calorimetry (Schindler and Folliard, 2005). Semi-adiabatic refers to test conditions where the heat loss is so low as to closely resemble adiabatic.

In-place temperatures can be controlled by:

1. Limiting the total cementitious materials content.
2. Controlling the fresh concrete placement temperature.
3. Proper selection of the cementitious material types.

The amount of total cementitious materials has implications relative to design compressive strength. However, concrete design stresses are often quite low in drilled shafts and so it is prudent that the mixture design requirements not exceed the actual performance requirements for design. Because of concerns for setting time and heat of hydration, the use of additional Portland cement to accommodate an unnecessarily high strength requirement can have other implications on mixture performance. When it comes to cement content, more is not always better!

The data shown in Figure 9-22 demonstrate the benefits of controlling the fresh concrete placement temperature to control the rate of hydration. Temperature controls at the batch plant can be achieved by substituting some of the mixing water with ice, or with liquid nitrogen thermal probes that are used to cool the concrete in the truck.

The use of Type II cement and high dosages of Class F fly ash and/or GGBF slag are often the best options to control heat of hydration. Concrete mixtures with high dosages of fly ash or GGBF slag will tend to generate less heat of hydration and are also less prone to DEF.

### **9.6.6 Mixture Proportions**

The proportions of water, cement, supplementary cementing materials, chemical admixtures, and aggregate required to achieve a given set of target concrete properties (workability, workability retention, strength, permeability) should be determined on a job-by-job basis using the trial-mixture design method (e.g. Kosmatka et al., 2002). The trial mixture testing and evaluation of that testing should be carried out by a qualified concrete laboratory. Care should be taken to verify that the conditions that existed in the trial mixture tests continue to exist during construction. If conditions change (aggregate source, cement source, supplementary cementing material type or dosage, type of chemical admixture, etc.), new trial mixture studies should be conducted to ensure that the target properties will continue to be achieved.

Example mixture proportions for drilled shaft concrete are shown in Tables 9-1 and 9-2. The proportions shown in Table 9-1 represent conventional drilled shaft concrete mixes that have produced cohesive concrete mixtures for use in wet hole placement operations. The proportions shown in Table 9-2 represent “SCC” type concrete mixes that have been used successfully in drilled shaft applications. The most appropriate mixture for a specific project will depend on the characteristics of local materials and project requirements (placement method, duration of placement, required passing ability, durability requirements, SCM availability, etc.). The most appropriate chemical admixtures that should be used for a mixture should be selected by the concrete producing company with input from the chemical admixture supply company, and verified by trial mixes and application in technique shafts.

**TABLE 9-1 EXAMPLES OF MIXTURE PROPORTIONS FOR  
CONVENTIONAL DRILLED SHAFT TREMIE CONCRETE**

Item	Mixture Type			
	WashDOT	Caltrans (SoCal)	SCDOT	New England
Target Consistency	7 - 9 inch Slump	7 - 9 inch Slump	7 - 9 inch Slump	6 - 9 inch Slump
Type I or II Cement Content, lb/yd <sup>3</sup>	600	569	560	525
Class F Fly Ash Content, lb/yd <sup>3</sup>	-	189	140	225
GGBFS (Slag)	181	-	-	-
Water Content, lb/yd <sup>3</sup>	315(max)	358	289	300
No. 67 Coarse Aggregate (3/4" max), lb/yd <sup>3</sup>	-	-	1778	1166
AASHTO 8 Coarse Aggregate (3/8" max), lb/yd <sup>3</sup>	1601	-	-	515
Caltrans Blend (3/8" max), lb/yd <sup>3</sup>	-	1421	-	-
Fine Aggregate Content, SSD, lb/yd <sup>3</sup>	1262	1297	1181	1154
Water-to-Cementitious Materials Ratio	0.40(max)	0.47	0.41	0.40
Sand-to-Total Aggregate Ratio (by volume)	0.45	0.48	0.40	0.40
Extended-Set Control Admixture, oz/cwt	5.1(max)	8	4	8
Water Reducing Admixture, oz/cwt	6.4(max)	4(max)	8	4

**TABLE 9-2 EXAMPLES OF MIXTURE PROPORTIONS FOR  
"SCC" TYPE DRILLED SHAFT CONCRETE**

Item	Mixture Type			
	B.B. Comer Bridge, AL	Mullica River, NJ Turnpike	I-35W, Minneapolis	Lumber River, SC
Target Consistency	18-24 inch Slump Flow	18-24 inch Slump Flow	24 inch Slump Flow	18-24 inch Slump Flow
Type I or II Cement Content, lb/yd <sup>3</sup>	494	526	242	500
Class F Fly Ash Content, lb/yd <sup>3</sup>	210	132	108	250
GGBFS (Slag)	0	0	359	0
Water Content, lb/yd <sup>3</sup>	282	267	270	306
No. 67 CA (3/4" max), lb/yd <sup>3</sup>	1480	0	1330	1071
No. 8 CA (3/8" max), lb/yd <sup>3</sup>	0	1500	360	395
Fine Aggr. (Sand), SSD, lb/yd <sup>3</sup>	1390	1363	1350	1366
Water-to-Cementitious Ratio	0.40	0.405	0.38	0.41
Sand-to-Total Aggr. Ratio (by vol.)	0.48	0.48	0.44	0.48
Extended-Set Control Admixture, oz/cwt	8 (Delvo)	4 (Sika)	Unknown	8 (Delvo)
Water Reducing Admixture, oz/cwt	8 (Glenium 7700)	7 (Sika 2100 SP)	6 (BASF 7500)	8-12 (Glenium 3030)
VMA, oz/cwt	4	0	6	2

A trial mixture study for drilled shaft concrete should include testing to develop a graph of slump loss versus time after batching. Such a graph is shown in Figure 9-23. A desirable slump loss relationship is depicted, in which slump reduces slowly and still exceeds 4 inches four hours after batching. Four hours was selected because ordinarily this is the maximum time required for concrete placement. Other times could be selected as required. An undesirable slump loss relationship is also shown, in which the initial slump is quite appropriate but in which slump loss occurs rapidly about 90 minutes after batching, which is a potential problem when improper dosages of chemical admixtures are used or when the effect of warm weather conditions are not adjusted for. Care should be taken to perform slump loss tests at the approximate temperature at which the concrete will exist in the field. Without the adjustment of the dosages of retarding chemical admixtures, an increase in temperature of about 18 °F will increase the rate of slump loss by a factor of approximately 2, which means that a slump loss graph made in the laboratory at 72 °F will be very misleading for concrete being placed in the field at 90 °F.

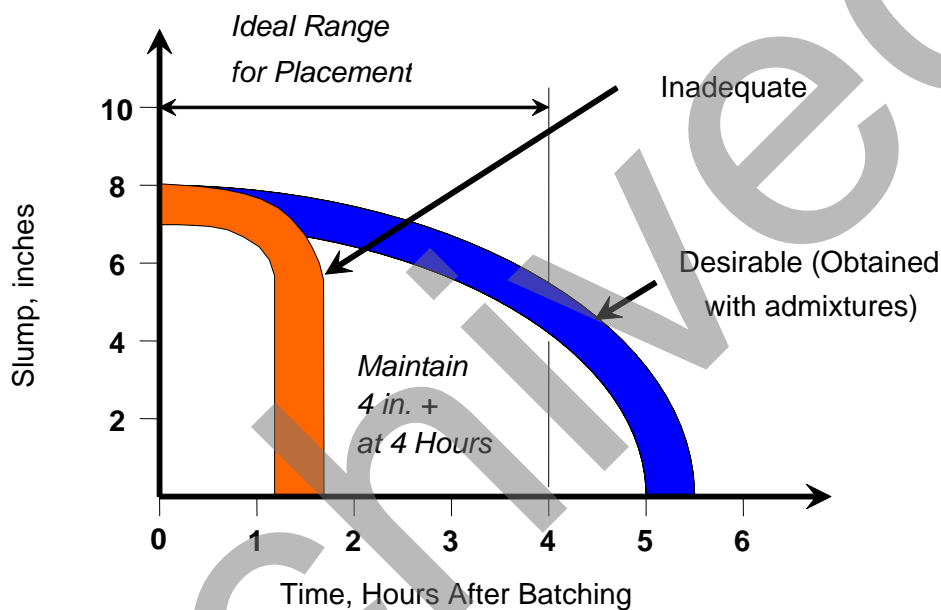


Figure 9-23 Slump Loss Relationship from a Trial Mixture Design

The mixture used in a project should not lead to excessive bleeding. Sliwinski (1980) defines an acceptable level of bleeding as less than 1 percent of the depth of the pour as long as bleeding does not occur through channels. The use of less mixing water and/or increase amounts of cementitious materials, and the use of air-entraining admixtures or viscosity modifying admixtures, should reduce bleeding if channelized bleeding becomes a problem.

Durability requirements must be considered when selecting the constituent materials and proportions of the concrete mixture. The reader is referred to Chapter 4 of ACI 318 for specific durability requirements for concrete mixtures exposed to various conditions. Soil and groundwater contaminants have the potential to cause deterioration of the concrete, particularly at the interface between the concrete and the geomaterial, where the transfer of load from the foundation to the geomaterial occurs. Sulfates react with the tricalcium aluminates ( $C_3A$ ) in Portland cement to produce ettringite. Sulfate-resistant cement is low in  $C_3A$  and so reduces the formation of ettringite. The use of sufficient amounts of SCMs in the concrete also improves concrete resistance to sulfate attack. Chlorides can attack the rebar, causing corrosion of the steel and subsequent cracking of the concrete produced by the expanding corrosive material. In a

high-chloride environment, epoxy coated rebar can be used as an alternate to, or in addition to, low-permeability concrete; however, some state departments of transportations prefer to use only low-permeability concrete produced by using a reduced w/cm with the addition of SCMs.

If the site conditions are aggressive, consideration should be given to producing a concrete of reduced permeability by adding supplementary cementing materials (SCMs) to the mixture. The use of a permanent casing around the drilled shaft can help to address concrete durability concerns through a high aggressive exposure zone. An aggressive subsurface environment can be considered to exist when the soil, rock or groundwater has free oxygen and/or carbon dioxide (e.g., partially saturated soils), has high concentrations of sulfates or chlorides, or is substantially acidic. Table 4.2.1 of ACI 318 (2008) provides a maximum w/cm limit, a minimum strength, and requirements for the cementitious material composition that depend on the severity of potential exposure to external sources of sulfates. If the water-soluble sulfate in the soils exceeds 0.10 percent by mass or the sulfate (SO<sub>4</sub>) in the groundwater (SO<sub>4</sub>) exceeds 150 ppm, then the requirements of ACI 318 (2008) should be followed to protect concrete against possible sulfate attack. Some industrial contaminants (usually organic wastes, alkalis and salts) can also be aggressive. Expert assistance should be solicited when industrial contaminants are encountered on a site.

Table 9-3 shows typical Portland cement replacement rates for some supplementary cementing materials that should be considered for drilled shaft concrete. These amounts vary from location to location since the quality of both the cement and SCMs vary. Therefore, Table 9-3 should be considered only a general guide. Local concrete specifications should be consulted before arriving at a final mixture design. Silica fume is typically used to obtain very low permeability concrete for projects that require extended design lives. The use of silica fume will adversely affect concrete workability, and concrete experts should be consulted when it is used in drilled shaft applications.

**TABLE 9-3 TYPICAL PROPORTIONS OF POZZOLANIC ADDITIVES**

<b>Type of Supplementary Cementing Material</b>	<b>Cement Replacement Dosage (percent of total cementitious material by weight)</b>
Class C Fly Ash	20 to 30 %
Class F Fly Ash	15 to 25 %
Slag Cement	30 to 50 %
Silica Fume	5 to 8 %

Note: Ternary mixtures made with both fly ash and slag cement typically contain up to 20% fly ash and 30% slag cement by weight of total cementitious materials.

Chemical admixtures should be pre-qualified before use, and the procedure used by TxDOT contains an example of this process (TxDOT, 2008a). Table 9-4 is a partial list of some pre-approved air entraining admixtures and approximate dosages that are permitted by TxDOT (2008b), which requires that all chemical admixtures for concrete be pre-qualified. Note that the list in Table 9-4 is not complete and that other admixtures are perfectly acceptable according to TxDOT. The products shown are merely provided as examples. Permissible admixtures may vary from state to state.

**TABLE 9-4 TYPICAL PROPORTIONS OF SOME TXDOT PRE-APPROVED AIR ENTRAINING CHEMICAL ADMIXTURES (TXDOT, 2008b)**

Product	Dosage in mL per 100 kg (oz. per 100 lb.) of Cement	Approx. % Solids (for mix design)	Producer
AEA-92	33 to 65 (1/2 to 1)	6	Euclid Chemical Corp.
AEA-92S	33 to 130 (1/2 to 2)	3	
Air-Mix 200	33 to 65 (1/2 to 1)	15	
Air-In (12%)	33 to 130 (1/2 to 2)	12	Hunt Process-Southern
Air-In -XT	33 to 130 (1/2 to 2)	7	
Air Plus	16 to 81 (1/4 to 1 1/4)	98	Fritz-Pak Corp.
Super Air Plus	16 to 81 (1/4 to 1 1/4)	97	
Daravair AT30	15 to 200 (1/4 to 3)	10	W. R. Grace
Daravair AT60	15 to 200 (1/4 to 3)	20	
Daravair-1000	33 to 195 (1/2 to 3)	5	
Darex AEA	49 to 195 (3/4 to 3)	6	
Darex II AEA	33 to 195 (1/2 to 5)	10	
Eucon Air 30	33 to 260 (1/2 to 4)	3	Euclid Chemical Corp.
Eucon Air 40	16 to 260 (1/4 to 4)	13	
Eucon NVR	16 to 260 (1/4 to 4)	12	
Euco Air Mix	33 to 65 (1/2 to 1)	15	
MB AE 90	16 to 260 (1/4 to 4)	6	BASF Admixtures
MB-VR	16 to 260 (1/4 to 4)	13	
Micro-Air	8 to 260 (1/8 to 4)	12	
Pave-Air	16 to 260 (1/4 to 4)	13	
Pave-Air 90	16 to 260 (1/4 to 4)	6	

Figures 9-24 to 9-28 contain photographs of potential concrete mixtures for drilled shafts. The photograph in Figure 9-24 shows the results of a slump test where the concrete has a slump of 1.5 inches. The workability of the mixture is insufficient for the placement by a tremie, by pump, or even by free fall through a dropchute, because the concrete will not flow readily through the tremie, will not compact under its own weight, and will not flow through the rebar cage without vibration (which is unacceptable in drilled shafts). Serious placement problems can arise if such a concrete is used. It is possible that the addition of a high-range water reducing admixture will bring this mixture to an acceptable level of workability, but care must be taken that the mixture has been designed for this additional increase in high-range water reducing admixture as segregation could result. Before the addition of the high-range water reducing admixture, the “wet-slump” of self-consolidating concrete mixtures designed for drilled-shaft applications may only be 2 to 4 inches; however, once the HRWR admixture is added the slump flow of these mixtures range from 18 to 24 inches.

The concrete mixture in Figure 9-25 has a high slump, but excess water is clearly evident that could lead to segregation or excessive bleeding. Slump alone, therefore, is not a complete measure of workability.

The concrete shown in Figure 9-26 is an appropriate mixture for drilled shafts when the concrete is to be placed by a gravity-fed or pump-fed tremie. The workability is high, placement will be easy, and self-consolidation should be achieved under its own weight. The maximum size of the coarse aggregate is  $\frac{1}{2}$  to  $\frac{3}{4}$  inch, and the sand content and cement content are relatively high compared to the coarse-aggregate content. The mixture is homogeneous and cohesive, and placement can be made without segregation or bleeding. The high slump has been achieved with a w/cm of 0.45 through the use of a low-range water reducer. The smaller size of the coarse aggregate will allow the concrete to flow through the rebar.

The slump shown of the mixture in Figure 9-27 is close to the lower limit for a drilled shaft and should only be used in a relatively simple application such as a dry shaft with light reinforcement.

An example of the appearance of the workability desired in a well-proportioned self-consolidating concrete mixture is shown in Figure 9-28. The SCC in this picture has a slump flow of 20 inches and there are virtually no signs of segregation, which is essential for these types of concretes. With time the effectiveness of the HRWR admixture will wear off and the behavior of the SCC will start to become similar to convention concrete and eventually a conventional slump test can be performed on the concrete sampled at placement. The admixtures used in the SCC should be selected to ensure that the desired slump is retained to allow the completion of tremie placement and removal of the temporary casing.



Figure 9-24 Concrete with Insufficient Workability for Use in Drilled Shafts (Kosmatka et al, 2002)



Figure 9-25 Concrete with High Workability but with Potential for Bleeding and Segregation

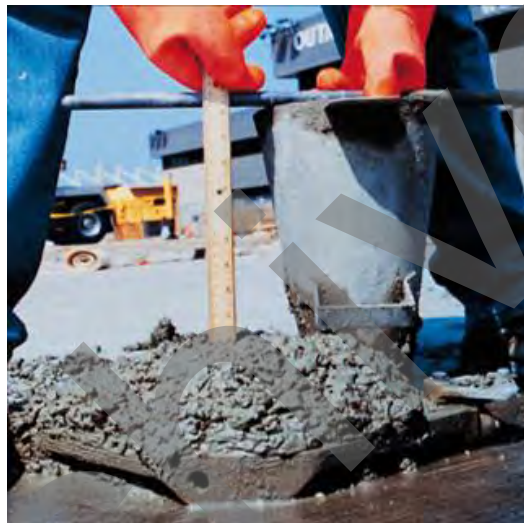


Figure 9-26 Drilled Shaft Concrete with High Workability - 9.0 inch Slump (Kosmatka et al, 2002)



Figure 9-27 Drilled Shaft Concrete with Moderate Workability - 6.5 inch Slump

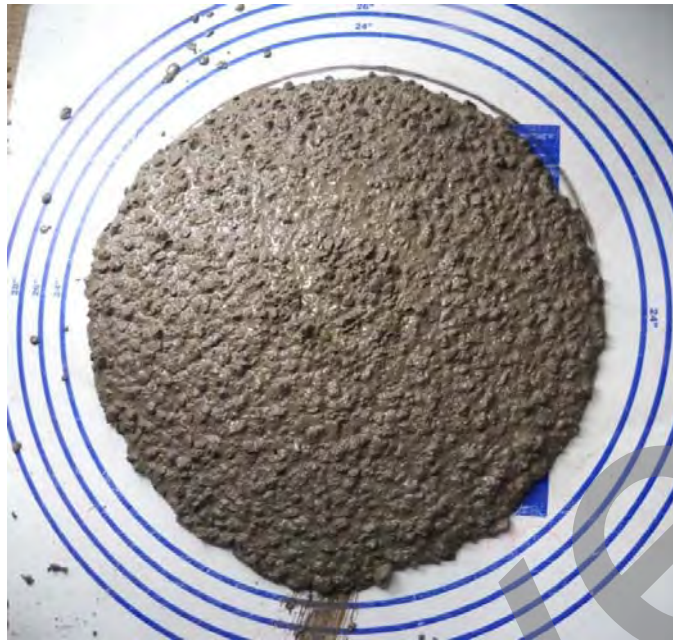


Figure 9-28 Self-Consolidating Concrete with a 20-inch Slump Flow Used in Drilled Shaft Construction

### 9.6.7 Communication of Project Specific Requirements for the Concrete

All too often the specific requirements of the drilled shaft project are not clearly defined for the concrete supplier during the project bid stage. The mixture that will perform well during placement and meet all the project requirements for a specific project will depend on many variables which may include: duration of the placement, level of rebar congestion, concrete placement method, shaft construction method, targeted service-life, etc. During the bid stage, all the performance requirements for the mixture must be clearly defined. If *all* concrete producers do not bid on a mixture that satisfy all the project performance requirements, then the nature of the competitive bid process may deliver a producer that either underbid the cost associated with the project or a producer that may not be able to deliver concrete that meets all the performance requirements for the project.

Some drilled shaft projects are such that the shafts are less than 4-ft in diameter and their length allows all the concrete for a shaft to be placed in less than 3 hours. Most concrete producers will be able to use their “standard” mixture that has “worked well in past projects” for these shafts without spending much additional resources on pre-testing the mixture. However, should a project arise that requires drilled shafts that are 12-ft diameter and 150-ft deep with very congested levels of reinforcement then obviously the mixture that has “worked well in past projects” may not meet all project requirements.

Communication is required among all project participants including project owner, designer, contractor, and concrete producer. The specific project performance criteria must be clearly defined in the project bid documents so that time and cost allowances can be made by the contractor and concrete producer for extensive testing during the mixture development stage to develop a high-performance concrete mixture that meets all project requirements. The contractor must communicate to the concrete producer any relevant conditions that may impact the concrete mix, including anticipated concrete handling and placement methods, estimated duration for concrete transportation and placement, and anticipated



ambient temperature conditions (summer, winter, etc.), among others. The concrete producer must be prepared to work cooperatively with the contractor to develop a mix that can meet all of the relevant requirements to complete the project.

### **9.6.8 Strength**

The strength of drilled shaft concrete is normally specified by its 28-day compressive strength as tested on 6-inch diameter by 12-inch high cylinders. Most mixtures for drilled shafts will be adequate if they produce 28-day compressive cylinder strengths in the range of 3,500 to 4,000 psi. However, higher strength concrete can be useful under conditions in which the designer wishes to make use of very strong bearing strata and reduce the cross-sectional area of the drilled shaft, which will produce high compressive stresses in the concrete, or for cases in which high combined bending and axial stresses will be applied to the drilled shaft. Very often, the quantity of cement and SCM used to achieve workability will result in much higher compressive strength values than is required by the designer.

Design strengths of 6,000 psi have been used because of seismic design requirements and are achievable with the use of lower w/cm values to produce very low permeability concrete and high-performance concrete. Since the setting time of concrete is reduced when lower w/cm are used, care should be taken to ensure acceptable workability retention behavior, especially under warm weather placement conditions. Higher strength mixtures will typically contain a greater proportional amount of cementitious materials which can result in higher in-place temperatures in the concrete during curing. Curing temperatures can be a consideration for large diameter drilled shafts.

## **9.7 CONCRETE TESTS**

### **9.7.1 Testing to Obtain Mixture Approval**

During the development of a mixture all tests that provide some indication of concrete performance during placement should be used. Trial batches can be developed under laboratory conditions or by a concrete batch plant. Initially, many trial batches of the proposed mixture can be made, with variations to bracket the range of variables such as cement content, SCM dosage, chemical admixture dosage, etc. It is not uncommon for very large projects to evaluate more than thirty mixtures before a final mixture(s) is selected. It is also common practice to develop trial mixtures at three different w/cm values in order to allow interpolation to obtain the w/cm that produces a concrete mixture with local materials that meet the required specified compressive strength for the project. During trial batching the slump, fresh concrete temperature, total air content (if required), and cylinder samples for later strength testing should be performed for conventional drilled shaft concrete.

For self-consolidating concrete mixtures the slump flow and the VSI tests (ASTM C 1611, 2005) should be used to assess the workability of the trial batches. In addition, the static segregation of the SCC should be assessed by using the column technique (ASTM C 1610, 2006). This static segregation test is important to perform for drilled shaft concrete that usually has extended setting times and are subject to the effects of gravity that may cause vertical segregation in the shaft. The static segregation test outlined in ASTM C 1610 is too cumbersome and time consuming to use on the jobsite, but it should be used to pre-qualify SCC developed for drilled shaft applications before use. From the static segregation test a percent static segregation is obtained, which should not exceed 10% (ACI 237, 2005).

The final step of trial batching should require the construction of a full-scale technique shaft to evaluate the performance of the selected mixture when batched in the concrete producer's batch plant and placed

by the project contractor. Where possible, the conditions of the full-scale technique shafts should reproduce the level of rebar congestion of production drilled shafts, the shaft size, placement temperature conditions, and conservative estimates of the haul time including potential delays. During the installation of the full-scale technique shaft, the placement characteristics, fresh concrete properties, strength, permeability, etc. as required for the project should be assessed.

### 9.7.2 Tests at the Batch Plant

Most concrete for drilled shafts is supplied by ready-mix plants, but in some cases the job is large enough to justify the use of a batch plant at the jobsite. Jobsite batch plants have also been used for remote locations where ready-mix plants were not available. A photo of a worksite batch plant that was set up for a large bridge project is provided in Figure 9-29. Some suppliers also can bring batched dry ingredients to a job site and blend and mix them with water only when the contractor is ready to make the pour; however, on-site mixers typically have a limited load capacity. Jobsite batching allows the contractor to exercise control over this aspect of the schedule and minimize exposure to concrete delivery problems from an off-site plant.



Figure 9-29 Worksite Concrete Batch Plant Capable of Batching 130 yd<sup>3</sup>/hr

In any case, tests at the concrete batch plant site are necessary. Items that can be checked are the nature and quantities of the components of the mixture, the aggregates, cementitious materials, water, and chemical admixtures. There have been occasions when errors have been made at the plant in the mixture proportions, with the error not being found until cylinders are broken at some later date. The consequences of such errors can cause great difficulty and construction delays. Kosmatka et al. (2002)

state that “specifications generally require that materials be measured for individual batches within the following percentages of accuracy: cementitious materials  $\pm 1\%$ , aggregates  $\pm 2\%$ , water  $\pm 1\%$ , and admixtures  $\pm 3\%$ .”

It would not be unusual for the aggregates to change as a job progresses, such that a new mixture design would be required. Depending on how the aggregates are stored, the moisture content of the aggregate may experience rapid changes with time so that the amount of water to be added to the mixture must be adjusted four times per day or even more frequently to ensure that the actual approved water content is not exceeded in each concrete batch. Accurate control of the water added to each batch is even more critical in SCC type mixtures that typically have reduced water contents and obtain their workability from the use of HRWA admixtures. Modern concrete batch plants utilize moisture probes that take real-time measurements of the moisture content of the aggregates.

An important factor in the making of concrete is the temperature of the components of the mixture. For example, hot aggregates and mixing water could produce accelerated setting in the concrete during placement. An inspector at the batch plant should check the temperature of the components and of the completed mixture for conformance with the specifications.

### **9.7.3 Tests at the Jobsite**

The organization of the job must be such that the time required to perform tests at the jobsite is kept to a minimum. There are two reasons: first, the excavation should remain open for as short a period of time as possible to reduce the chance of creep and caving in the soil or rock, and, second, the concrete should be placed as rapidly as possible so that the workability of the concrete will remain high during the entire placement operation. Because of the first requirement, batch-plant inspection and the timely ordering and delivery of concrete should be emphasized. Delivery of concrete that does not meet the project specification requirements should be avoided; rejection of delivered concrete can cause additional problems because a delay in placement of concrete may result in caving of the borehole, collection of sediment on the top of the concrete already placed in an excavation during a slurry pour, or a slump loss that is so large that workability is lost and casing cannot be extracted as planned.

While it is not strictly a test of the concrete, care must be taken to ensure that sufficient concrete is at the jobsite or in transit to the jobsite so that the entire pour can be completed as near continuously as possible without delay. Thus, it is essential for the contractor to make an estimate of the as-built size of the excavation to order enough concrete to fill the excavation, allowing for some inevitable losses. It is also essential that the contractor estimate the time required to complete the construction of the shaft, including contingency for some delay. The time required for construction must be passed along to the concrete producer, which can then add sufficient amounts of retarding admixtures to allow the concrete to remain sufficiently workable throughout the construction of the whole shaft.

Jobsite inspection is essential to ensure that unacceptable concrete does not enter the drilled shaft. Jobsite concrete testing should be viewed as a process of verification and not as a process of control. The recommended minimum jobsite testing is to measure temperature, which can be done rapidly, slump, total air content (if required), and to recover cylinder samples for later strength testing. If SCC is used, then the slump flow and the VSI tests (ASTM C 1611, 2005) should be used to assess the workability of the concrete delivered to site.

Different state agencies have different rules for frequency of sampling. Generally, a set of cylinders consists of two 6 by 12 inch cylinders. At least of one set of concrete cylinders should be made and tested

per drilled shaft, but not more than one set per truckload for quality assurance. Cylinder samples can be made from small representative samples recovered from each ready-mix truck in a few minutes, freeing the truck to deposit concrete in the borehole immediately. It is important that the sampled concrete is representative of the concrete delivered to site; otherwise test results may be misleading. Samples should not be taken from the first or last part of the concrete discharged from the truck. Cylinders should be cured and tested in accordance with project specifications.

Because many projects require placement by gravity tremie or pump, the concrete that arrives first at the top of the shaft is normally that which was placed first. It is thus recommended in large pours to test the workability (slump) retention of the mixture by sampling and periodically testing concrete from the first load placed in the shaft. The ability of the concrete to retain sufficient workability is most often tested by performing the slump test at a prescribed time after start of concrete placement in the shaft. Most agencies have specification requirements that outline how the concrete samples should be stored for the workability retention test. It is recommended that the fresh concrete for the workability retention be sampled at the point of discharge into the tremie or pumpline and stored in a sealed container that is not exposed to direct sun light or vibration. Care should be taken, however, to keep the sampled concrete at similar temperatures to those that exist deep in the ground at the construction site (often between 55 and 66 deg. F in the contiguous 48 states); otherwise, the slump values will not be representative of the condition of the in-place concrete. Prior to performing the workability retention test the concrete should be slightly agitated by mixing it with a shovel. It is also recommended to overpour the shaft to confirm that good-quality, uncontaminated concrete continues to flow from the borehole.

Where concrete is placed with a dropchute (e. g., in the dry or casing methods), the first concrete placed will remain on the bottom of the borehole. It is still desirable that this concrete remain workable until the last concrete is placed at the top of the drilled shaft to ensure that ground pressures are reestablished.

#### **9.7.4 Addition of Water at Jobsite**

One of the reasons for rejecting a batch of concrete is that the slump is too low. The question always arises as to the advisability of adding water to the concrete in a ready-mix truck. The added water will increase the workability, but it will have the detrimental effect of reducing the strength and durability of the concrete. The result of adding water at the jobsite could be a significant change in the characteristics of the mixture and increase the possibility of segregation as the pour is made.

In some cases only part of the mixing water is added at the batch plant, and some of the water is *withheld* from the approved total mix water with the specific intention to add it at the jobsite. In either of these cases, the amount of water permitted to be added at the jobsite should be stated on the mixture batch sheet carried by the ready mix truck driver. If water is intentionally withheld and the ready-mix truck has a way to accurately measure the volume of water added on site, then additional water can then be added without harm. If the slump is then adequate, the pour can begin. In some unusual circumstances such as very long or unpredictable travel times from the batch plant to the jobsite, consideration may be given to bringing dry ingredients to the jobsite and mixing them with water just prior to placement.

If all water permitted by the mixture design has been added and the slump is still not high enough, the inspector must note the deficiency and inform the contractor. The contractor is then faced with the decision of adding water sufficient to bring the slump up to the minimum value or ordering new concrete. The decision is a difficult one in situations where additional delay can have other negative consequences. On the other hand, adding water beyond that which is permitted may risk introducing concrete into the shaft which does not meet the project requirements. Where durable concrete of low permeability is essential due to aggressive environments, the addition of excess water may be absolutely disallowed by

the contract. Where low permeability is not a major concern, the contractor might choose to proceed at risk, with extra samples obtained for verification testing. If deficiencies are determined to exist, evaluation and repair techniques are discussed in Chapter 21.

## 9.8 SUMMARY

One of the most critical aspects of the construction and design of drilled shaft foundations is the completion of concrete placement operations to ensure construction of a structurally sound drilled shaft foundation. This chapter has provided a description of concrete placement techniques and equipment covering a broad range of conditions, including a discussion of common problems related to field operations and how to avoid them. The mix characteristics of drilled shaft concrete are also described, with particular emphasis on the design of the mix to achieve the fresh concrete properties that are needed to achieve constructability. Select examples of successful mix designs are provided, along with recent advances in the development of concrete mixes for challenging drilled shaft construction conditions. Routine tests performed for quality control and quality assurance are also described.

With an appreciation of the important issues described in this chapter on drilled shaft concrete and previous chapters on other aspects of drilled shaft construction, an engineer is prepared to consider the design aspects of drilled shaft foundations described subsequently and to “design for constructability”.

Archived

This page is intentional left blank.

## CHAPTER 10

### LRFD FOR DRILLED SHAFTS

An important change to this version of the manual is that all design methods are presented exclusively in the format of Load and Resistance Factor Design, or LRFD. In the previous edition (O'Neill and Reese, 1999) primary emphasis was on Allowable Stress Design (ASD), sometimes referred to as traditional factor of safety design, with LRFD presented as an alternative. The AASHTO LRFD Bridge Design Specifications appeared in 1992 and are now in their 4<sup>th</sup> edition. The states, through AASHTO, established a goal that LRFD standards be incorporated into all new bridge designs after 2007. Design of drilled shafts by LRFD is, therefore, a logical step forward because it provides compatibility between the superstructure and foundation designs, and is consistent with evolving design philosophies that incorporate sources of uncertainty into each component of load and resistance.

#### 10.1 INTRODUCTION TO LRFD

All structural and foundation design approaches have one common objective: *structural safety*. The traditional approach to provide adequate safety of foundations has been to apply a global factor of safety to the computed available capacity, or:

$$Q_{des} \leq Q_{all} = \frac{Q_{ult}}{FS} \quad 10-1$$

where:

$Q_{des}$	=	design load applied to the foundation
$Q_{all}$	=	allowable load
$Q_{ult}$	=	ultimate load capacity
FS	=	global factor of safety ( $\geq 1$ )

In this approach the designer addresses the risk of adverse performance (collapse, excessive deformations, etc.) through a single parameter, the global factor of safety. The factor of safety is intended to provide a structural capacity (resistance) that exceeds the expected load, in order to account for the variability and uncertainty in *both* the load and the resistance. Factors that impact the actual performance, including variations in loads and material strengths, quality of construction, and the possibility of unforeseen subsurface conditions, are lumped into a single factor of safety. This approach has several shortcomings, the most significant of which is that it does not provide a consistent and rational framework for incorporating the individual sources of engineering risk into the design. No consideration is given to the fact that each component of load and resistance has a different level of variability and uncertainty.

The global factor of safety approach has been replaced by the concept of *limit state design*. The essential idea is that a design should start by identifying all potential failure modes or limit states. A limit state is defined as a condition for which some component of the structure does not fulfill its design function. A limit state can be defined in terms of geotechnical strength, such as ultimate bearing capacity, or in terms of serviceability, for example allowable settlements. A check is conducted on each limit state and it must be shown that its occurrence is sufficiently improbable. The format of limit state design equations involves the application of *partial factors* to increase the loads and decrease the resistances. This

approach represents a fundamental improvement over the single factor of safety approach because the partial factors are applied directly to the uncertain quantities (loads and resistances).

As proposed originally, the partial factors were determined subjectively based on two criteria: (1) a larger partial factor should be applied to a more uncertain quantity, and (2) the partial factors should result in approximately the same dimensions as those obtained from traditional practice. This approach does not satisfy one of the basic requirements of limit state design: demonstrating that the occurrence of each limit state is sufficiently improbable. The next logical step in limit state design, therefore, has been to apply probabilistic reliability analysis to the establishment of the partial factors, in order to account properly for the uncertainty and variability of each component of force and resistance. Probabilistic methods form the basis of limit state design in structural engineering and represent the direction in which foundation design is now proceeding. One of the advantages of this approach is that all components of the structure, including the foundations, can be designed to a uniform level of safety. In other words, for a given limit state, the probability of failure is approximately the same for all components of the structure. This approach is expected to result in designs that are more cost-effective and with a more clearly defined and uniform level of safety.

The platform of probabilistic limit state design adopted by AASHTO and used in this manual is LRFD, in which the partial factors applied to loads are termed *load factors* and those applied to resistances are *resistance factors*. For example, the LRFD format applied to the geotechnical strength limit state of a drilled shaft under axial compression can be expressed as follows:

$$\gamma_P Q_{PN} + \gamma_L Q_{LN} \leq \phi_S R_{SN} + \phi_B R_{BN} \quad 10-2$$

in which:

$\gamma_P$	=	load factor for permanent load
$Q_{PN}$	=	nominal axial permanent load
$\gamma_L$	=	load factor for live load
$Q_{LN}$	=	nominal axial live load
$\phi_S$	=	resistance factor for side resistance
$R_{SN}$	=	nominal value of side resistance
$\phi_B$	=	resistance factor for base resistance
$R_{BN}$	=	nominal value of base resistance

The LRFD design requirement, as implemented by AASHTO, can be stated more generally as follows: *for each limit state, the summation of factored force effects may not exceed the summation of factored resistances*, or:

$$\sum \eta_i \gamma_i Q_i \leq \sum \phi_i R_i \quad 10-3$$

where:

$\eta_i$	=	a load modifier to account for ductility, redundancy, and operational importance of the bridge or other structure (dimensionless)
$\gamma_i$	=	load factor; a multiplier applied to force effect $i$
$Q_i$	=	force effect $i$
$\phi_i$	=	resistance factor for resistance component $i$
$R_i$	=	nominal value of resistance component $i$



A force effect is defined as an axial load, shear, or moment transferred to the foundation as a result of loads acting on the structure.

### 10.1.1 Development of Resistance Factors

In general, it is not necessary for a design engineer to conduct reliability analyses to apply LRFD to drilled shaft design (although reliability analyses *may* be used for calibration of site-specific or geologically specific conditions, or for design equations which have not been calibrated). In design codes, such as the AASHTO LRFD Bridge Design Specifications (2007), the mathematical and statistical analyses required for calibration are conducted by researchers and form the underlying basis for recommended values of load and resistance factors which can then be used by engineers for routine design. However, it is absolutely critical that practicing design engineers recognize the limitations of published values of resistance factors on the basis of how they were determined. Each resistance factor value is the product of a calibration study in which a specific design equation is evaluated for its ability to predict a specific component of foundation resistance (*e.g.*, side or base resistance) to within a specified target probability of failure. The resulting resistance factor value is thus valid only for the specific range of parameters encompassed by the calibration study. Specifically, this means that each resistance factor is limited to design problems satisfying the following:

- The design equation must be exactly the same as that used for calibration
- The load factors used in the design problem coincide with those used in the calibration
- The geomaterial type is the same as that for which the calibration study was conducted
- Soil and rock properties used in the analysis must be determined and interpreted in a manner that is consistent with those used in the calibration analysis

As described by Withiam et al. (1998) calibration, the process of assigning values to load factors and resistance factors, can be carried out by the use of: (1) judgment, (2) fitting to other codes or past practice, (3) probabilistic-based reliability analyses, or (4) a combination of approaches. Only the third approach, reliability based calibration, satisfies the stated objective of limit state design, which is to establish load and resistance factors to achieve a defined target probability of failure.

If calibration is carried out by using judgment, it is implied that the participants possess the relevant experience. Ideally, the experience would include both satisfactory performance and unsatisfactory performance (*i.e.*, limit states have been reached), in order to select appropriate resistance factors. An example of judgment-based calibration might be a case where code-prescribed resistance factors could be changed on the basis of unsatisfactory past performance. Judgment alone, however, does not achieve the goal of uniform levels of safety throughout the structure.

#### 10.1.1.1 Calibration by Fitting

Calibration by fitting to past practice merely transforms the format of the past procedure, for example ASD, to LRFD format without any change in safety or reliability and also does not lend itself to quantifying the probability that a limit state will occur. However, fitting to ASD should result in designs that do not deviate radically from past practice and is sometimes used as a starting point when the performance data required for reliability-based methods are not sufficient, or the necessary calibration studies have not been conducted. Fitting also provides a means to check that the results obtained from

reliability-based methods are reasonable. Fitting a resistance factor to past practice in terms of a factor of safety can be calculated using the following expression for the case where loads are limited to permanent and live components only:

$$\phi = \frac{\gamma_P \left( \frac{Q_{PN}}{Q_{LN}} \right) + \gamma_L}{FS \left( \frac{Q_{PN}}{Q_{LN}} + 1 \right)} \quad 10-4$$

Where:  $\phi$  = resistance factor,  $\gamma_P$  and  $\gamma_L$  = permanent and live load factors, respectively,  $Q_{PN}$  and  $Q_{LN}$  = nominal permanent and live loads, respectively, and FS = factor of safety from ASD.

### 10.1.1.2 Calibration by Reliability Theory

Calibration by reliability methods involves establishment of load and resistance factors corresponding to a target probability that failure will occur. Failure in limit state analysis is defined as a condition for which the force effect (Q) exceeds the available resistance (R). The parameters Q and R are treated as independent random variables. The distribution of frequency of occurrence for Q and R can be characterized by a distribution function, typically a normal distribution or lognormal distribution. This makes it possible to characterize Q and R by statistical parameters that quantify their variability. The relevant parameters are the mean, standard deviation, and coefficient of variation. The mean value,  $\bar{x}$  of a data set  $x = (x_1, x_2, \dots, x_N)$  is calculated as:

$$\bar{x} = \frac{\sum x_i}{N} \quad 10-5$$

Where N = number of data values. The mean is also referred to as the average value or the expected value of the data. The standard deviation  $\sigma$ , is a measure of the dispersion of the data about the mean, in the same units as the data, and is given by:

$$\sigma = \sqrt{\frac{\sum (x_i - \bar{x})^2}{N - 1}} \quad 10-6$$

The coefficient of variation (COV), defined as the ratio of the standard deviation to the mean, expresses the magnitude of variability as a percentage or fraction of the mean value:

$$COV = \frac{\sigma}{\bar{x}} \quad 10-7$$

Figure 10-1(a) shows normal distributions of frequency of occurrence for force effect (Q) and resistance (R). The mean value of force effect is denoted by  $\bar{Q}$  and the mean value of resistance is denoted by  $\bar{R}$ .

A limit state occurs when the force effect exceeds the resistance, represented by the shaded area in Figure 10-1a. The difference between resistance and force effect, defined by the limit state function  $g = R - Q$ , is a quantitative measure of the margin of safety. This function can be characterized by its own distribution, mean, and standard deviation, as shown in Figure 10-1b. The limit state (failure) is defined at the point where  $g$  is equal to zero ( $Q = R$ ). The area beneath the curve in the region where the limit state function  $g$  is less than zero represents the probability of failure (probability of the limit state occurring). The probability of failure can also be expressed conveniently in terms of a *reliability index*, denoted by  $\beta$ . The reliability index represents the distance measured in standard deviations between the mean safety margin and the failure limit. The probability of failure is related to  $\beta$  as summarized in Table 10-1

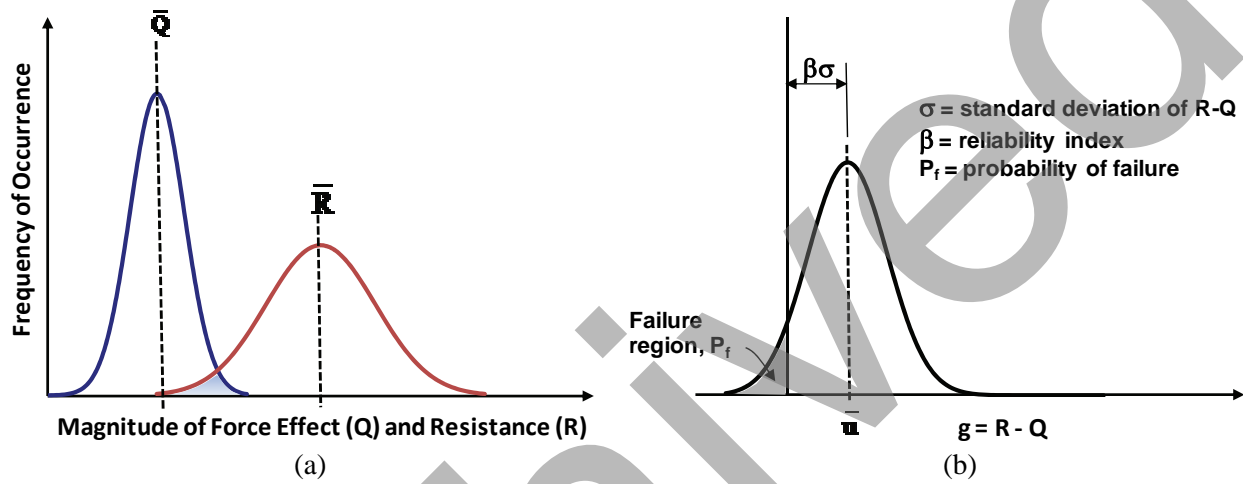


Figure 10-1 Reliability Concepts: (a) Distributions of Force Effect and Resistance, and (b) Reliability Index (adapted from Withiam et al., 1998; and Allen, 2005)

**TABLE 10-1 RELIABILITY INDEX IN TERMS OF PROBABILITY OF FAILURE**

Reliability Index, $\beta$	Probability of Failure
2.0	1 : 10
2.5	1 : 100
3.0	1 : 1,000
3.6	1 : 10,000
4.1	1 : 100,000
4.6	1 : 1,000,000

The resistance ( $R$ ) calculated using a specific limit state design equation is referred to as the nominal (predicted) resistance. To perform a reliability-based calibration of the design equation, the nominal resistance must be evaluated against measured values of resistance to establish its *bias*, defined as the ratio of measured to nominal value. The load and resistance data along with bias are used to develop a cumulative distribution function (CDF), a plot that represents the probability that a bias value less than or equal to a given value will occur. The CDF is then used to scale the data used in the reliability-based calibration in order to account for bias.

The general steps for calibration of resistance factors using reliability theory described by Withiam et al. (1998) and Allen (2005) are summarized below:

- Compile the data on force effects and resistances needed to determine the statistical parameters that characterize their distribution and variability; from these data calculate the mean, standard deviation, and coefficient of variation (COV) for each variable.
- Estimate the reliability inherent in current design procedures.
- Select a target level of reliability, taking into account the margin of safety implied in current designs, the need for consistency with reliability levels applied throughout the AASHTO specifications, and considering levels of reliability for geotechnical design as reported in the literature.
- Calculate resistance factors consistent with the target reliability index and using load factors specified by AASHTO for the limit state under consideration.

The final step, calculation of resistance factors, entails the application of various reliability models which vary in their level of rigor and in the underlying assumptions. In order of increasing complexity, the most commonly used methods are:

Mean Value First Order Second Moment (MVFOSM): The limit state function ( $g$ ) is linearized at the mean values of  $Q$  and  $R$  (hence the term ‘mean value’). The mean and standard deviation of  $g$  are determined from a Taylor series expansion in which only the first order terms are considered (hence the term ‘first order’). This method requires the random variables to be represented by their first two moments, the mean and standard deviation. Explicit equations can be written for  $\beta$  with this method, making MVFOSM the most simple technique, but it is also the least accurate.

Advanced First Order Second Moment (AFOSM): The limit state function ( $g$ ) is linearized at the design point (where  $Q = R$ ) rather than at the mean value. An iterative procedure is required in which an initial value of  $\beta$  is assumed and used to establish an initial design point. The calculations are conducted and yield a new value of  $\beta$ . The procedure is repeated until the difference between values of  $\beta$  on successive iterations converges to within a small tolerance ( $\pm 0.05$ ). The method considers the mean, standard deviation, and distribution function, and involves normal approximations to non-normal distributions at the design point. The method was developed by Rackwitz and Fiessler (1978). Implementation of the iterative computational procedure requires use of a computer.

Monte Carlo Simulation: This technique involves using random numbers and probability to extrapolate values of the cumulative distribution function (CDF) for each random variable. For this extrapolation, the CDF is characterized by the mean, standard deviation, and type of function (normal, lognormal, etc.). This extrapolation, or simulation, of the CDF plots makes estimating  $\beta$  possible, even when the quantity of measured data is inadequate to reliably estimate  $\beta$ . Details of this method and its application to calibration studies are presented by Allen et al. (2005). In its most simple form, the Monte Carlo method is primarily a curve fitting and extrapolation tool and can be implemented using spreadsheet software.

The current state of practice in LRFD design of drilled shafts for transportation facilities incorporates resistance factors that have been established by a variety of calibration methods including all of the approaches identified above. The ultimate goal of LRFD methods presented in FHWA publications is to have all resistance factors established on the basis of reliability analyses. In some cases, fitting to past practice in terms of ASD has been conducted and, in combination with judgment, has been used to select resistance factors. This approach is considered a temporary measure until the proper reliability-based

calibrations are conducted. The resistance factors recommended in this manual are summarized later in this chapter (Section 10.4) which also briefly describes the basis of each factor.

## 10.2 AASHTO LIMIT STATES AND LOAD COMBINATIONS

The AASHTO Specifications (AASHTO, 2007), Article 3.4, identify twelve potential limit states that may require evaluation for design of a bridge. As summarized in Table 10-2, these include five limit states pertaining to strength, two pertaining to extreme events, four pertaining to serviceability, and one pertaining to fatigue. A unique combination of loads is specified for each of the twelve limit states. A general description of each load combination is given in Table 10-2, and the specific loads included in each category along with applicable load factors are presented in Table 10-3. Some of the load designations shown in Table 10-3 consist of multiple load components (specifically, permanent load and live load), each of which is evaluated separately. Individual load factors assigned to the various components of permanent load are presented in Table 10-4. Additional load factor values for  $\gamma_{EQ}$ ,  $\gamma_{TG}$ , and  $\gamma_{SE}$  are specified in AASHTO (2007).

The most common limit states for which drilled shaft foundations are designed include: Strength I, Strength IV, Extreme Event I (earthquake), Extreme Event II (ice, vessel and vehicle collision), and Service I. Strength IV applies to large ratios of dead load to live load, which often governs the design of drilled shafts used to support long-span bridges over water. Any of the Strength or Extreme Event Limit States could be critical for a particular structure and could govern the foundation design. Service Limit States II, III, and IV and the Fatigue Limit State are used to check the behavior of certain superstructure elements and are not relevant to foundation design.

**TABLE 10-2 AASHTO (2007) LIMIT STATES FOR BRIDGE DESIGN**

Limit State Type	Case	Load Combination
<b>Strength</b>	I	Normal vehicular use of the bridge without wind
	II	Use of the bridge by Owner-specified special vehicles, evaluation permit vehicles, or both, without wind
	III	Bridge exposed to wind velocity exceeding 55 mph
	IV	Very high dead load to live load force effect ratios
	V	Normal vehicular use of the bridge with wind of 55 mph
<b>Extreme Event</b>	I	Load combination including earthquake
	II	Ice load, collision by vessels and vehicles, and certain hydraulic events with a reduced live load other than that which is part of the vehicular collision load, <i>CT</i>
<b>Service</b>	I	Normal operational use of the bridge with a 55 mph wind and all loads taken at their nominal values
	II	Intended to control yielding of steel structures and slip of slip-critical connections due to vehicular live load
	III	Longitudinal analysis relating to tension in prestressed concrete superstructures with the objective of crack control and to principal tension in the webs of segmental concrete girders
	IV	Tension in prestressed concrete columns with the objective of crack control
<b>Fatigue</b>		Repetitive gravitational vehicular live load and dynamic responses under the effects of a single design truck



The limit states to be evaluated for a particular bridge or other structure are determined by the structural designer. For each limit state, the process of establishing foundation force effects can be summarized as follows. A structural model of the proposed bridge is developed and analyzed under the load combination corresponding to the limit state being evaluated (Table 10-3). Loads used in the analysis are factored. Foundation supports are modeled (typically) as springs or by using an assumed “depth of fixity”. The depth of fixity models the column as being fixed at a depth that will result in the same lateral deflection as would occur in the actual column supported by the foundation. Determination of the spring constants or depth of fixity may be based on preliminary analyses of load-deformation response of trial foundation designs by the geotechnical engineer. As illustrated in Figure 10-2, the reactions at the column-foundation joint computed by the structural analysis are taken as the force effects transmitted to the foundations. For drilled shafts, the reactions are resolved into vertical, horizontal, and moment components, and these are taken as the factored values of axial, lateral, and moment force effects, respectively. Multiple iterations are often performed in order to obtain agreement between deformations and forces at the structure/foundation interface as calculated by the structural analysis and those based on geotechnical analysis. The resulting factored force effects are substituted into Equation 10-3 (left-hand side). Although this is a somewhat oversimplified description of the actual process, it is the general procedure by which factored foundation force effects are determined, for each applicable limit state.

Also note that some of the load factors given in Table 10-3 and Table 10-4 are specified over a range of values. For foundation design, modeling of the structure while varying the load factors over the specified range is necessary to determine the combination resulting in maximum force effects on the foundations, which are then used in limit state checks.

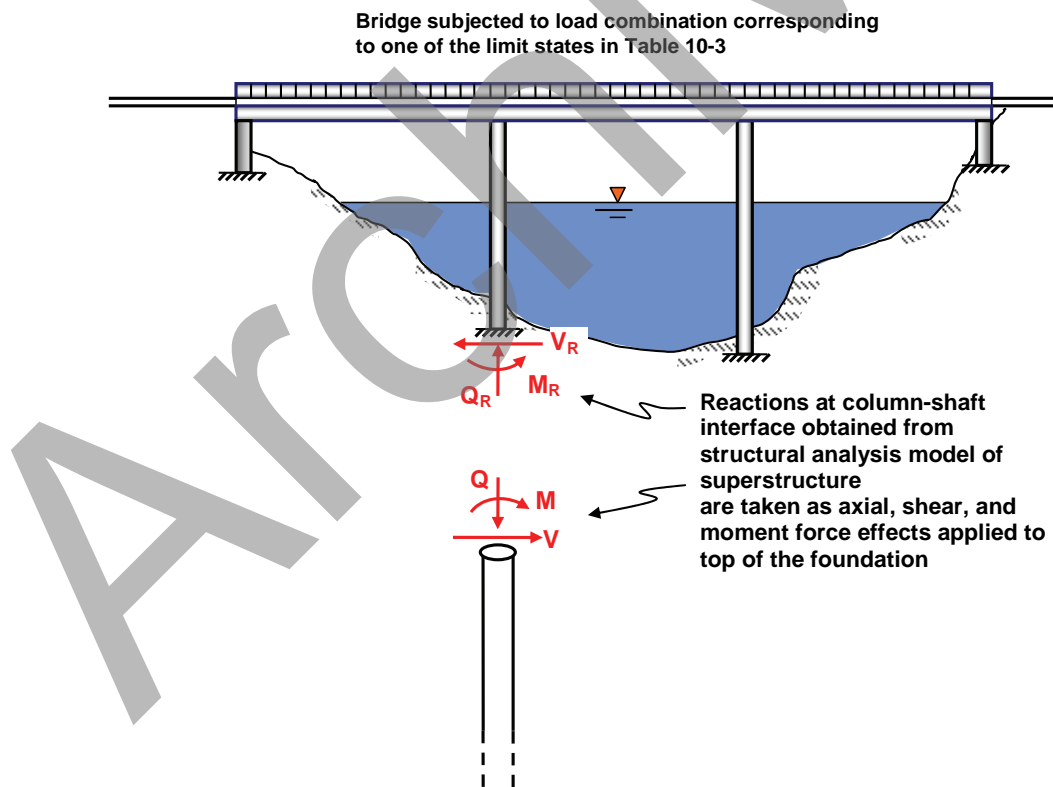


Figure 10-2 Structural Analysis of Bridge Used to Establish Foundation Force Effects

### 10.3 AASHTO LIMIT STATES AND DRILLED SHAFT RESISTANCES

Articles 10.5.3.4 and 10.8.3 of the AASHTO Specifications (2007) identify the following nominal resistances to be considered for design of drilled shafts at strength limit states:

- Lateral geotechnical resistance of soil and rock stratum, for single shafts and shaft groups
- Geotechnical axial compression resistance, for single shafts and shaft groups
- Geotechnical axial uplift resistance, for single shafts and shaft groups
- Structural resistance of shafts, including checks for axial, lateral, and flexural resistances
- Punching of shafts through strong soil into a weaker layer
- All of the above resistances under scour at the design flood
- Axial resistance when downdrag occurs

Articles 10.5.2 and 10.8.2.2.1 of the AASHTO Specifications (2007) describe the criteria for satisfying Service Limit State I. Each drilled shaft or group of shafts must be designed so that deformations do not exceed criteria established for the bridge or other structure. The deformations to be checked include:

- Settlement (vertical deformation)
- Horizontal movements at the top of the foundation
- Rotations at the top of the foundation
- Settlement and horizontal movements under scour at the design flood
- Settlement due to downdrag

Tolerable vertical and horizontal deformations for the structure under consideration are established by the structural designer in accordance with criteria presented in Article 10.5.2.1, based on structural tolerance to total and differential movements, rideability, and economy.

Extreme events are loading cases with expected return periods that exceed the design life of the structure, but which must be considered within the context of limit state design. Extreme Event I (earthquake) and Extreme Event II (ice; vessel and vehicle collision) may require evaluation, depending on the location of the structure and the risk associated with its exposure to seismicity, ice flows and collision by vessels or vehicles. For each extreme event limit state that applies to the structure (I, II, or both), foundations should be designed to have adequate factored lateral, axial, and structural resistances. These include all of the resistances identified above that are considered for strength limit states.

An important distinction is made when designing for scour. Scour is considered at two levels. Scour resulting from the *design* flood, defined as a flood with a return period of 100 years, is to be considered for all strength and service limit states for which the bridge is designed. Scour resulting from the *check* flood, defined as a superflood with a return period of 500 years, is considered to be an extreme event and is addressed separately in Chapter 15. General aspects of scour are described in Section 13.5. More specific aspects of design for scour are considered in the relevant design chapters (Chapters 12 through 16).

Concurrent with establishment of factored loads, as described in Section 10.2, the foundation engineer evaluates the relevant resistances of trial drilled shaft designs using the methods presented in subsequent chapters of this manual. These include analysis for lateral and moment loading (Chapter 12), axial loading (Chapter 13), group behavior (Chapter 14), extreme events (Chapter 15), and structural design



(Chapter 16). Each of those chapters includes additional discussion of loads and load factors, as well as descriptions of the mechanics and theory underlying the methods recommended for calculating nominal resistances. The factored resistances are then substituted into the right-hand side of Equation 10-3 for comparison with the factored force effects. This comparison constitutes a limit state check.

## 10.4 RESISTANCE FACTORS FOR DRILLED SHAFTS

### 10.4.1 Summary of Resistance Factors

The resistance factors presented in this manual for design of drilled shafts are summarized in Table 10-5. Most of these resistance factors are those recommended by AASHTO (2007) and correspond to design methods and equations presented in the 1988 and 1999 versions of this manual (Reese and O'Neill, 1988; O'Neill and Reese, 1999). Where new or updated equations are recommended, these equations and associated resistance factors are not included in the current AASHTO (2007) specifications. This includes the following cases:

1. Geotechnical lateral resistances by  $p$ - $y$  pushover analysis for Strength Limit States (first 3 rows of Table 10-5).
2. Geotechnical axial side resistance for Strength Limit States, for cohesionless soils by the Beta method (Row 4 of Table 10-5)
3. Geotechnical axial side resistances in rock (Row 6 of Table 10-5)

The remaining resistance factors in Table 10-5 for axial geotechnical strength limit states of drilled shafts are based on recommendations given by Allen (2005), which also are the values adopted in the current AASHTO LRFD specifications (AASHTO, 2007). The resistance factors recommended by Allen (2005) come from three sources:

1. NCHRP Report 343 by Barker et al. (1991)
2. NCHRP Report 507 by Paikowsky et al. (2004)
3. Reliability-based analyses conducted by Allen (2005) taking into account changes in load factors since the 1991 study.

Commentary in the AASHTO LRFD Specifications (AASHTO, 2007) describes the resistance factors as:

“developed using either statistical analysis of drilled shaft load tests combined with reliability theory (Paikowsky et al., 2004), fitting to Allowable Stress Design (ASD), or both. When the two approaches resulted in a significantly different resistance factor, engineering judgment was used to establish the final resistance factor, considering the quality and quantity of the available data used in the calibration”.

For resistance factors established using reliability theory, the target reliability index was  $\beta = 3.0$ , corresponding to a probability of failure of 1 in 1,000. In the following paragraphs, the source of each resistance factor given in Table 10-5 is identified and discussed briefly. For the resistance factors attributed to Allen (2005) the reference should be consulted for additional details on the selection process.

**TABLE 10-5 SUMMARY OF RESISTANCE FACTORS FOR LRFD DESIGN OF DRILLED SHAFT FOUNDATIONS**

Limit State	Component of Resistance	Geomaterial	Equation, Method, or Chapter Reference	Resistance Factor, $\phi$
Strength I through Strength V Geotechnical Lateral Resistance	Pushover of individual elastic shaft; head free to rotate	All geomaterials	<i>p</i> - <i>y</i> method pushover analysis; Ch. 12	0.67 <sup>(1)</sup>
	Pushover of single row, retaining wall or abutment; head free to rotate	All geomaterials	<i>p</i> - <i>y</i> pushover analysis	0.67 <sup>(1)</sup>
	Pushover of elastic shaft within multiple-row group, with moment connection to cap	All geomaterials	<i>p</i> - <i>y</i> pushover analysis	0.80 <sup>(1)</sup>
Strength I through Strength V Geotechnical Axial Resistance	Side resistance in compression/uplift	Cohesionless soil	Beta method (Eqs. 13-5 to 13-15) <sup>(2)</sup>	0.55 / 0.45
		Cohesive soil	Alpha method (Eq. 13-17)	0.45 / 0.35
		Rock	Eq. 13-20 <sup>(2)</sup>	0.55 / 0.45 <sup>(3)</sup>
		Cohesive IGM	Modified alpha method (Eq. 13-28)	0.60 / 0.50 <sup>(1)</sup>
	Base resistance	Cohesionless soil	N-value (Eq. 13-16)	0.50
		Cohesive soil	Bearing capacity eq. (Eq. 13-18)	0.40
		Rock and Cohesive IGM	1. Eq. 13-22 2. CGS, 1985 (Eq. 13-23)	0.50
	Static compressive resistance from load tests	All geomaterials		$\leq 0.7$ <sup>(4)</sup>
	Static uplift resistance from load tests	All geomaterials		0.60
	Group block failure	Cohesive soil		0.55
Group uplift resistance	Cohesive and cohesionless soil		0.45	
Strength I through Strength V; Structural Resistance of R/C	Axial compression			0.75
	Combined axial and flexure			0.75 to 0.90
	Shear			0.90
Service I	All cases, all geomaterials		Ch. 13, Appendix B	1.00
Extreme Event I and Extreme Event II	Axial geotechnical uplift resistance	All geomaterials	Methods cited above for Strength Limit States	0.80
	Geotechnical lateral resistance	All geomaterials	<i>p</i> - <i>y</i> method pushover analysis; Ch. 12	0.80 <sup>(1)</sup>
	All other cases	All geomaterials	Methods cited above for Strength Limit States	1.00

<sup>1</sup>Currently not addressed in AASHTO (2007)

<sup>2</sup>Design equation differs from AASHTO (2007)

<sup>3</sup>Resistance factor different from AASHTO

<sup>4</sup>See AASHTO Table 10.5.5.2.3-1

### Strength Limit States, Geotechnical Lateral Resistance by Pushover Analysis (Chapter 12):

The current AASHTO Specifications (2007) assign a resistance factor of 1.00 to the lateral (horizontal) geotechnical resistance for evaluation of strength and extreme event limit states. However, the resistance factors for geotechnical lateral resistances given in Table 10-5, which are less than 1.0, are recommended in order to ensure geotechnical stability of drilled shafts under lateral loading. In Chapter 12, a “pushover” analysis procedure is described, in which the lateral load and moment are increased incrementally up to values exceeding the factored force effects in order to provide a check on the ability of a drilled shaft to withstand the factored loads without becoming unstable and to ensure a ductile lateral response. This method is not included in current AASHTO specifications. The resistance factors for lateral loading presented herein are based on analyses conducted by the authors and engineering judgment, and have not been established through a reliability-based calibration study. They should therefore be considered as preliminary values subject to future revision.

### Strength Limit States, Geotechnical Axial Resistance (Chapter 13):

1. Side Resistance: the resistance values given in Table 10-5 for side resistance show two values, the first for compression loading and the second value for uplift. As recommended by Allen (2005), resistance factors for uplift are assumed to be 0.10 lower than the values for compression. Until further reliability-based calibration studies are available, this recommendation is followed herein.

(a) *Cohesionless Soil, Beta Method.* This method represents a change from the depth-dependent beta method in the previous edition of this manual and currently recommended in AASHTO (2007). The rationale for making this change is presented in Appendix C. This method has not been calibrated for AASHTO load factors using probabilistic reliability analysis. As an interim recommendation the resistance factor given in Table 10-5 is calculated by fitting to the ASD factor of safety used in current practice, based on the assumption of permanent and live load components only. Using the current AASHTO load factors for permanent load ( $\gamma_P = 1.25$ ) and live load ( $\gamma_L = 1.75$ ) with a factor of safety  $FS = 2.5$ , an assumed ratio of permanent to live load equal to 3, and substituting into Equation 10-4 yields:

$$\phi = \frac{1.25(3.0) + 1.75}{2.5(3.0 + 1)} = 0.55 \quad 10-8$$

The resistance factor calculated above can be modified for different values of load factors, permanent to live load ratios, or factor of safety using Equation 10-4. The resistance factor for uplift ( $\phi = 0.45$ ) is obtained by decreasing the value for compression by 0.10. The resistance factor for uplift can also be calibrated by fitting to the current ASD factor of safety for uplift, which is equal to  $FS = 3.0$ . Using the same load factors and assumed ratio of live to dead load as above, Equation 10-4 yields  $\phi = 0.46$ , which is rounded to 0.45.

(b) *Cohesive Soil, Alpha Method.* This method is not changed from the previous version of this manual (O’Neill and Reese, 1999). The values in Table 10-5 ( $\phi = 0.45$  for compression,  $\phi = 0.35$  for uplift) are recommended by Allen (2005) based on a combination of fitting to the ASD factor of safety ( $FS = 2.5$  for compression,  $FS = 3.0$  for uplift) and taking into account the reliability-based analysis conducted by Paikowsky et al. (2004).

(c) *Rock.* The method for side resistance in rock is given by Equation 13-20 and described in greater detail in Section 13.3.5.3. Equation 13-20 is similar in format to the design equation

recommended for side resistance in rock by O'Neill and Reese (1999), referred to as the "Horvath and Kenney" method based on their 1985 study. Research based on field load tests during the ensuing 25+ years justifies the updated version of this equation as discussed in Chapter 13. The resistance factor in Table 10-5 of  $\phi = 0.55$  is based on fitting to the ASD factor of safety  $FS = 2.5$ . This value is considered interim until a valid reliability-based calibration is conducted. The value for uplift ( $\phi = 0.45$ ) is obtained by decreasing the value for compression by 0.10, or by fitting to the ASD factor of safety for uplift,  $FS = 3.0$ . This should also be considered an interim recommendation subject to further calibration. The resistance factor given by AASHTO (2007) for uplift in rock is  $\phi = 0.40$ ; however this value does not apply to Equation 13-20.

(d) *Cohesive IGM, modified alpha method.* This method is unchanged from the previous edition of this manual. The resistance factor in compression of  $\phi = 0.60$  is recommended by Allen (2005) on the basis of reliability calibration studies of Paikowsky et al. (2004). The uplift value is 0.10 less than the compression value.

## 2. Base Resistance

(a) *Cohesionless Soil, correlation to N-value.* This method is unchanged from O'Neill and Reese (1999). The recommended resistance factor ( $\phi = 0.50$ ) is recommended by Allen (2005) based on a combination of fitting to the ASD factor of safety ( $FS = 2.75$ ) and taking into account the reliability-based analysis conducted by Paikowsky et al. (2004).

(b) *Cohesive Soil, bearing capacity equation.* This method is not changed from O'Neill and Reese (1999). The value in Table 10-5 ( $\phi = 0.40$ ) is recommended by Allen (2005) based on a combination of fitting to the ASD factor of safety ( $FS = 2.75$ ) and taking into account the reliability-based analysis conducted by Paikowsky et al. (2004).

(c) *Rock and Cohesive IGM.* Several methods are presented in O'Neill and Reese (1999) and in this manual for calculating nominal unit base resistance in rock and cohesive IGM. In the current AASHTO specifications and in Allen (2005) resistance factors are recommended for the method given by the Canadian Geotechnical Society (CGS, 1985) and a method based on pressuremeter measurements, also given by CGS (1985). For these two cases Allen (2005) recommends  $\phi = 0.50$  based on fitting to ASD as reported by Barker et al. (1991). For the method based on uniaxial compressive strength of intact rock, corresponding to Equation 13-22 in this manual and originally proposed by Rowe and Armitage (1987), a value  $\phi = 0.50$  is recommended; this recommendation is also based on Barker, et al. (1991).

## 3. Axial Resistances from Load Testing

According to Allen (2005), when load testing is conducted for measurement of axial compressive resistance, a resistance factor  $\phi = 0.70$  for strength limit states is obtained by fitting to historical ASD practice. This is the basis for the recommendation in Table 10-5 not to exceed  $\phi = 0.70$ . Lower values may be recommended on the basis of site variability and the number of load tests conducted, in accordance with Table 10.5.5.2.3-2 in AAASHTO (2007). This table is based on data for piles but is recommended for drilled shafts, with the upper limit of 0.70. Examination of Table 10.5.5.2.3-2 shows that there are only two cases for which the resistance factor will be less than 0.70. Both correspond to sites for which subsurface variability is classified as "high". The criterion for high variability is that the coefficient of variation (COV) for the relevant geomaterial property value (N-values, undrained shear strength, etc.) is 40 percent or more. For high variability sites, if one load test is conducted the applicable resistance factor is  $\phi = 0.55$  and if

two load tests are conducted  $\phi = 0.65$ . If three or more load tests are conducted or if the site variability is classified as low or medium, the upper-bound value of  $\phi = 0.70$  may be applied.

For uplift resistance at sites where load testing is conducted  $\phi = 0.60$ . According to Allen (2005) no data were available to assess an appropriate resistance factor and the value of 0.60 was selected considering that failure in uplift can be abrupt and cannot be verified for production shafts without a load test. This value is also consistent with subtracting 0.10 from the resistance factor used for compression.

An issue that is not addressed in AASHTO (2007), specifically for drilled shafts, involves selection of the resistance factor for design when load testing is planned but has not yet been conducted. Design for strength limit states is based on a nominal (calculated) value of resistance, with the expectation that load testing results will verify that value. The question is whether to use the resistance factor associated with the design equation or the higher value allowed for load testing. For driven piles, AASHTO (2007) states: "The resistance factor selected for design shall be based on the method used to verify pile axial resistance as specified in Article 10.5.5.2.3". This statement implies that the design can be based on the resistance factor associated with load testing. The authors' opinion is that this approach can also be applied to design of drilled shafts. The potential risk is that axial resistance measured by load testing may be lower than the nominal resistance used for design, which could require increased shaft penetration that may be problematic, depending upon the capability of the drilled shaft equipment mobilized for the project.

#### 4. Group Axial Resistances

The value of  $\phi = 0.55$  for the strength limit state of a shaft group in clay in compression, for the assumption of a block failure mode, is taken from Allen (2005) who notes that no data are available for calibration; therefore this value is based on fitting to  $FS = 2.5$  using current AASHTO load factors. Similarly, no data are available on uplift of shaft groups. The value of  $\phi = 0.45$  is obtained by reducing by 0.10 the value for compression.

#### Strength Limit States, Structural Resistance of Reinforced Concrete

The resistance factors in Table 10-5 for structural design of drilled shaft reinforced concrete (R/C) are based on Section 5 (Concrete Structures) of the current AASHTO Specifications (2007) and are discussed further in Chapter 16 of this manual.

#### Service I and Extreme Event Limit States

Foundation resistance factors used for service limit state evaluation and extreme event limit states are assigned a value of 1.00, with the exception of uplift loading of single drilled shafts under extreme events, for which the resistance factor is 0.80, and for evaluating lateral stability under extreme event loading, for which the resistance factor is 0.80. Lateral stability is not addressed in AASHTO (2007) but is included in this manual for reasons discussed on p. 10-12. AASHTO states that assigning a resistance factor of 1.00 to non-strength limit states is a temporary measure until additional development work is completed on this topic.

### 10.4.2 Foundation Redundancy

An important issue affecting resistance factors is redundancy. The resistance factors given in Table 10-5 for drilled shaft side and base resistance, for strength limit states are based on the assumption of redundancy consistent with drilled shafts used in groups of two to four shafts. According to AASHTO, for shafts in groups of five or more, the factors in Table 10-5 for side and base resistance can be increased by up to 20 percent. For single shaft foundations, the factors in Table 10-5 for side and base resistance should be reduced to account for the lower redundancy. AASHTO (2007) notes that for single shaft foundations “the resistance factor values in the table should be reduced by 20 percent to reflect a higher target  $\beta$  value of 3.5, an approximate probability of failure of 1 in 5,000, to be consistent with what has been used generally for design of the superstructure”. Note that these adjustments for redundancy are not applicable to service limit states, structural strength, or lateral resistance. Also, the resistance factors shown in Table 10-5 for cases with static compression and static tension load tests are maximum values which should not be decreased for non-redundant foundations.

### 10.4.3 Comparison with Driven Piles

A comparison of the resistance factors given by AASHTO (2007) for driven piles (Table 10.5.5.2.3-1) to those presented above for drilled shafts will show that, in general, the drilled shaft resistance factors are higher. The same general approach was used to establish resistance factors for both deep foundation types, in that the same values of target reliability index were used for both piles and drilled shafts for design under static loading (Allen, 2005). However, the design equations used to establish nominal geotechnical resistances are different for piles and drilled shafts and therefore have different values of bias. Historically, design equations for drilled shaft have been conservative, (*i.e.*, lower-bound estimates of resistance have been used for design). This philosophy evolved to account for uncertainties associated with drilled shaft construction. It is logical to expect higher resistance factors when calibration is conducted using more conservative design equations. In addition, as noted by Allen (2005), the LRFD specifications imply that the reliability of the nominal pile resistance is a combination of the reliability of the static analysis method used and the field resistance verification method used (for example, dynamic methods). For these reasons, resistance factors for the two types of deep foundations cannot be compared directly.

## 10.5 CALIBRATION TO REGIONAL CONDITIONS OR AGENCY PRACTICE

The resistance factors presented in this manual as well as in AASHTO (2007) are intended to cover a wide range of conditions commonly encountered by transportation agencies involved in drilled shaft design using LRFD. However, given the wide range of geologic environments, natural variability of geomaterials, and different construction practices, there will always be design problems that do not fit within the general framework of these methods. Moreover, design methods with carefully calibrated resistance factors that are specific to local or regional geologic conditions and construction practices offer the potential for cost-effective and safe designs that work well for the agency willing to invest in their development.

A common starting point for converting existing ASD design methods to LRFD format is to use fitting to the factor of safety used in current practice. It is emphasized that calibration by fitting does not address the variability or bias of the prediction method and it is not possible to assess the probability of failure. Whatever margin of safety was implied by the ASD safety factor is simply carried over to the LRFD format without any change. Fitting should be considered an interim approach or as a check on reliability-based calibrations.

The process for developing reliability-based resistance factors for regionally-specific conditions or for design methods not covered by current LRFD specifications follows the same general framework outlined in Section 10.1 for calibration studies. For each limit state of interest, this involves compiling data on loads (force effects) and resistances, calculating the statistical parameters for characterizing loads and resistances (mean, standard deviation, type of distribution, bias), establishing a target level of reliability, and performing the calculations from reliability theory to determine resistance factors. Data on resistances is obtained from field load tests on drilled shafts. This is the recommended approach for achieving the objectives of LRFD.

The Circular by Allen et al. (2005) provides a detailed description of the process used to perform calibration of load and resistance factors as applied to limit state design for LRFD structural and geotechnical design, including the information needed. This publication is a highly recommended resource for agencies wishing to develop in-house or regionally specific design methods for drilled shafts.

As a final note, it is important to recognize that the application of design equations using LRFD, or any method, is only one component of ensuring satisfactory performance of drilled shafts. Other sources of risk are associated with site investigation, construction, inspection, and competent engineering throughout the project. No design equations will ensure safety if soil properties used in those equations are incorrect or if the drilled shaft is not constructed with proper control of quality.

## **10.6 SUMMARY**

The design methods presented in this manual are in the format of Load and Resistance Factor Design, or LRFD. AASHTO design specifications for bridges have been available in LRFD format since 1992, and LRFD standards should now be applied to the design of all components, including foundations, of new bridges.

The basic principles of LRFD are reviewed in this chapter. Load factors are applied to nominal loads acting on the structure in order to account for uncertainty and variability in actual loads. The factored loads are used in a structural model of the bridge or other structure to determine the force effects transmitted to drilled shaft foundations. Resistance factors are applied to nominal resistances in order to account for uncertainty and variability in the calculated resistances. The basic LRFD inequality, given by Equation 10-3, must then be satisfied for each applicable limit state. Resistance factors for all limit states pertaining to design of drilled shafts are given in Table 10-5, and the source of each resistance factor is identified. In subsequent chapters on design, numerical examples are presented to illustrate the application of LRFD methods.

Archived

This page is intentional left blank.



## CHAPTER 11 OVERALL DESIGN PROCESS

### 11.1 OUTLINE OF THE OVERALL DESIGN AND CONSTRUCTION PROCESS

Although this process on paper appears to suggest a step-by-step procedure, actual design of drilled shaft foundations is never performed in such a linear manner. The process will vary depending on the contracting process. Completion of the design for any project incorporates engineering judgment and a simultaneous consideration of numerous factors relating to typical resistance values, experience on previous projects, constructability, cost-effectiveness, and reliability. The size and complexity of the project will often determine the magnitude of work performed in the planning and preliminary phases. These early phases of the design process may include significant calculations based on preliminary site information which will be revised multiple times, or they may include only rudimentary estimates of drilled shaft performance based on experiences with similar projects. The complete design phase may require numerous iterations in order to achieve an optimal design, to accommodate constructability concerns, or to address changes to project requirements during the course of the work.

The overview of the overall design process presented herein provides a “roadmap” identifying the many different issues which must be considered by the designer. A complete logical process is important because a thorough review of all issues outlined in this roadmap serves as a checklist for designers and project managers. The sequence and definition of steps is not important, but it is critically important that all steps be taken to verify that important issues are not overlooked. It is particularly important that a review of major design issues as well as those issues pertaining to risk identification and constructability should be performed early in the process of planning, preliminary design, and foundation type selection. A more detailed treatment of specific design and construction issues is provided in the other chapters of this manual.

The reliability of a drilled shaft foundation system is inherently tied to the observational method in the field during construction and the verification that the design is constructed appropriately for the ground conditions actually encountered at each shaft location. Drilled shafts provide a flexible foundation solution that can allow for adjustments in the field when variable soil and rock conditions may be present. The design is typically based on some criterion of a minimum length of embedment into a designated bearing stratum or geological formation, and the final tip elevations may vary depending on variations of stratigraphy and the soil and rock conditions encountered during construction. A very thorough geotechnical investigation can minimize, but not eliminate, the potential deviations from planned tip elevations. The critical aspects of the design must be conveyed to construction and inspection personnel so that the design can be implemented properly and so that any unusual deviations from expected conditions can be identified and addressed appropriately.

The drilled shaft design-construction process is outlined in the flow chart of Figure 11-1. This flow chart provides a checklist to guide the designer through all of the tasks that must be completed and is discussed below using the numbers in the blocks as a reference. This checklist is also referenced in subsequent chapters of this manual and is intended to be used as a guide in the foundation design process for actual projects.

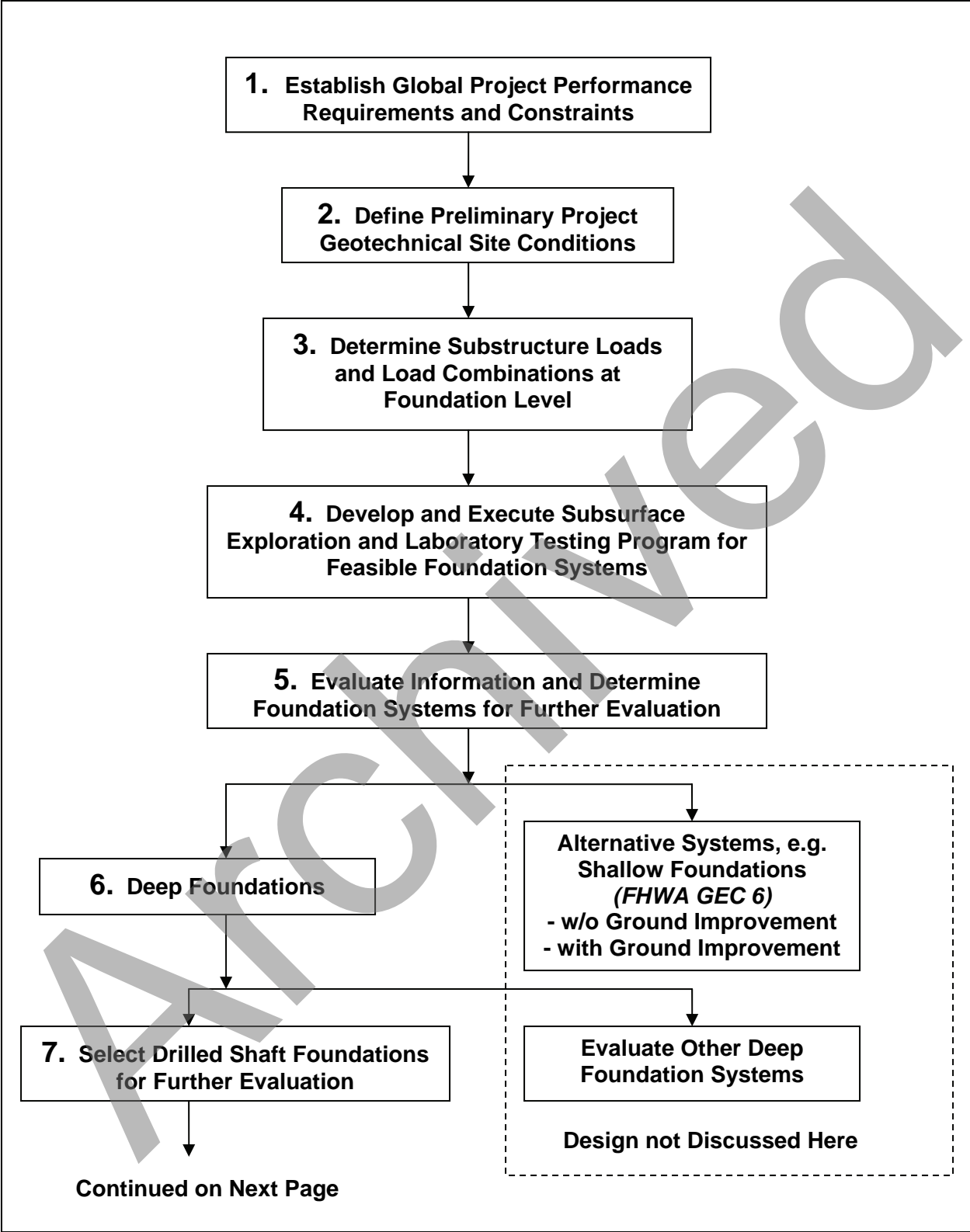


Figure 11-1 Drilled Shaft Design and Construction Process

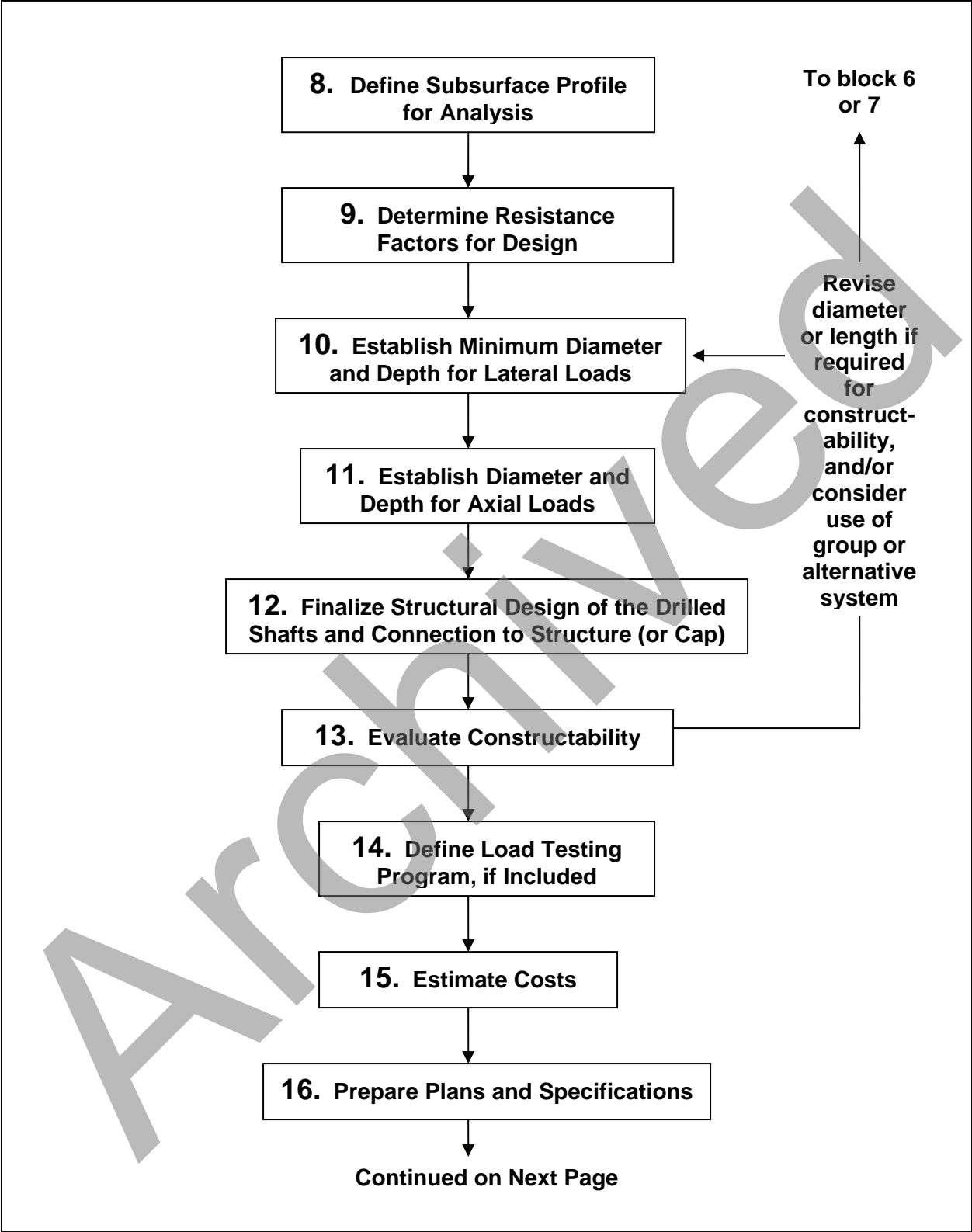


Figure 11-1 Drilled Shaft Design and Construction Process (continued)

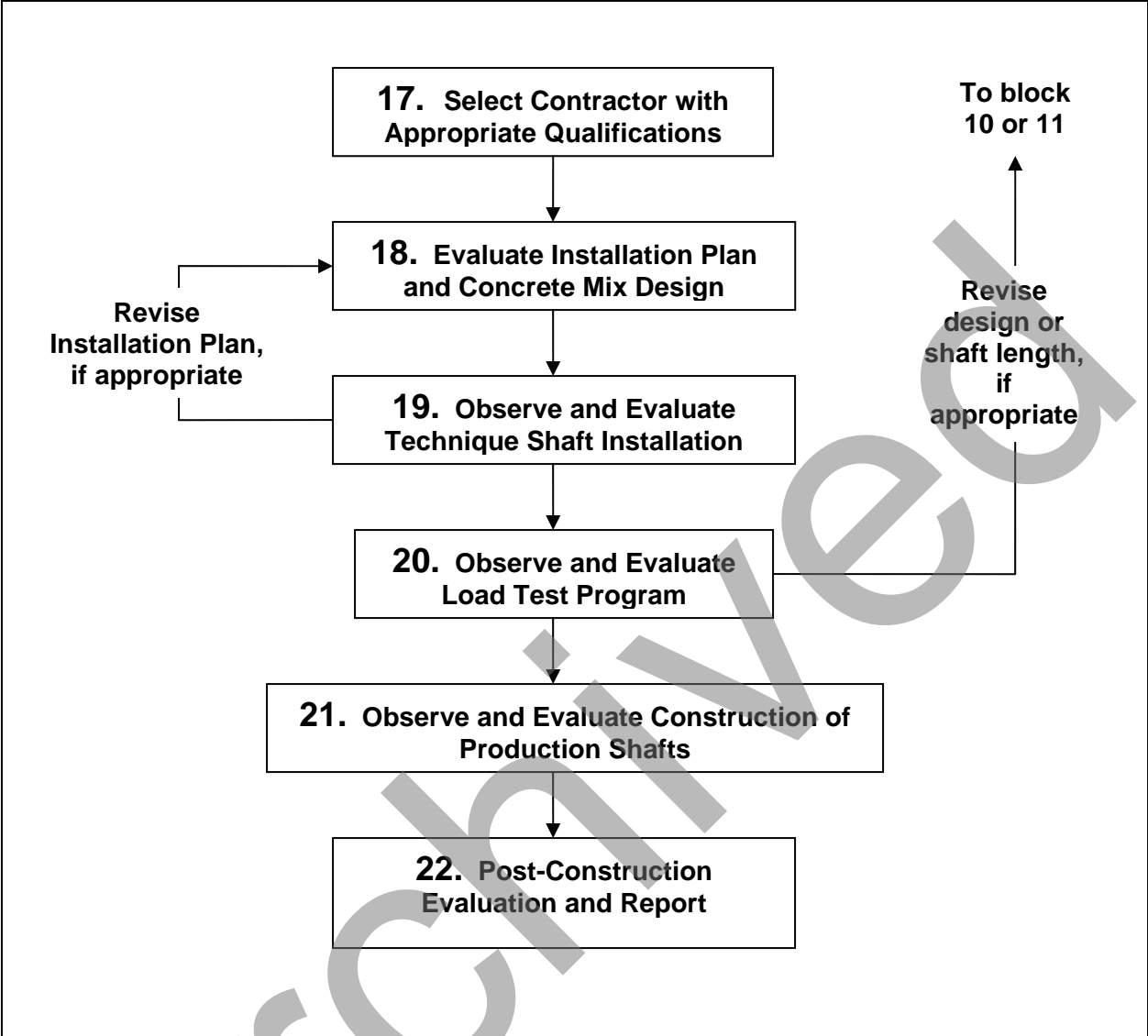


Figure 11-1 Drilled Shaft Design and Construction Process (Continued)

## **Block 1: Establish Global Project Performance Requirements and Constraints**

The first step in the entire process is to determine the general structure requirements.

1. Is the project a new bridge, a replacement bridge, a bridge renovation, a retaining wall or slope stabilization, a noise wall, a sign or light standard?
2. Are there any unusual project constraints or limitations with respect to foundation construction? Examples of constraints include accelerated work schedule, maintenance of traffic during construction, constrained workplace for construction equipment near existing structures, subsurface construction restraints near flood-control structures, tidal or river fluctuations, marine traffic, etc.
3. What is the most logical sequence of construction for the project; will the project be constructed in phases or all at one time? If in phases, are there potential conflicts with adjacent separate construction contracts? For example, it may be prudent to construct phase 2 foundations during phase 1 if the phase 2 construction would be very near the phase 1 structure. In some cases it may be prudent to delay some aspects of work to a subsequent phase if obstructions can be removed that will allow foundation construction to be performed with less constraints. For a replacement structure, the impact of construction on the traveling public may be minimized by constructing new foundations prior to demolition of existing structures; although the construction costs may be higher, the value to the public may be significant.
4. What are the general structure layout and approach grades?
5. What are the surficial site characteristics and general geologic setting?
6. Is the structure subjected to any special design events such as seismic, scour, downdrag, debris loading, vessel impact, etc? If there are special design events, the design requirements should be reviewed at this stage so that these can be factored into the site investigation.
7. Are there possible modifications in the structure that may be desirable for the site under consideration? Geotechnical design professionals should participate in the decision process during the planning phase of the project, where sometimes relatively simple modifications to the structure can offer significant savings or enhancements to reliability.
8. What are the approximate foundation loads? What are the deformation or deflection requirements for serviceability (total and differential settlement, lateral deformations)? Note that serviceability requirements may be affected by nearby structures.
9. Are there site environmental considerations that must be considered in the design (limitations on noise, vibrations, control of drilling fluids, possible contaminated spoils)?

## **Block 2: Define Preliminary Project Geotechnical Site Conditions**

A “desk study” combined with a site visit can often provide a substantial amount of information about the general geotechnical conditions at the site. Available information includes geologic and topographic maps, borings from previous projects at or nearby the site, and general knowledge within the local geology and area. A visit to a nearby quarry or road cuts can provide valuable first hand information about the character of a potential bearing formation.

Frequently, information is available on foundations that have been constructed in the area on other transportation or private projects, and this foundation construction experience can be quite valuable in assessing constructability and cost-effectiveness of drilled shafts. Deep foundation trade associations are usually willing and eager to share experiences from nearby or similar projects.

### **Block 3: Determine Substructure Loads and Load Combinations at Foundation Level**

Substructure loads and serviceability (displacement) criteria should be established for each of the load cases as described in Chapter 10. Approximate loads were considered in Block 1, and these may be only rough estimates at the time of conceptual design. Often, a set of preliminary foundation loads are developed during the preliminary design phase prior to the execution of the subsurface exploration (Block 4). It is essential that the foundation designer obtain a completely defined and unambiguous set of loads and performance criteria prior to completion of the foundation design process.

### **Block 4: Develop and Execute Subsurface Exploration and Laboratory Testing Program for Feasible Foundation Systems**

Based on the information obtained in Blocks 1-3, it is possible to make decisions regarding the necessary information that must be obtained for the feasible foundation systems at the site. The subsurface exploration and laboratory testing must provide sufficient and suitable information for both design *and* construction of drilled shafts and other candidate foundation systems, as described in Chapters 2 and 3. For large projects, the exploration and testing may be conducted in phases with a preliminary exploration to define the general characteristics followed by a more detailed exploration to obtain specific design information at each foundation location.

It should also be noted that the development of the subsurface exploration program is normally preceded by a preliminary foundation design based on available information from Block 2 or from a preliminary exploration program (Block 4). Thus, it is expected that a rough, preliminary evaluation and design (Blocks 5 through 15) may be performed before the final exploration program is conducted. The depth and extent of borings or soundings must be sufficient for the design depth and extent of deep foundation elements.

### **Block 5: Evaluate Information and Determine Foundation Systems for Further Evaluation**

The information obtained in Blocks 1-4 must be evaluated and candidate foundation systems selected. If a shallow foundation system is feasible and settlements, scour, liquefaction, footing size, etc. do not preclude their use, then shallow foundations are likely to provide the most economical solution. Ground improvement techniques in conjunction with shallow foundations may also be evaluated. Shallow and deep foundation interaction with approach embankments must also be evaluated. The design of shallow foundations and ground improvement techniques are not covered in this manual. Information on design considerations for shallow foundations can be found in Kimmerling (2002), and Munfakh *et al.*, (2001). Information on ground improvement techniques can be found in Elias *et al.*, (2004).

### **Block 6: Deep Foundations**

Where deep foundations are required, a decision must be made between drilled shafts and other deep foundation systems such as driven piles (Hannigan *et al.*, 2006), micropiles (Sabatini *et al.*, 2005), or continuous flight auger piles (Brown *et al.*, 2007). Since this manual is concerned with drilled shaft foundations, alternative deep foundation systems will not be described or discussed at length. However, the relative advantages and limitations of drilled shafts are typically considered in the light of alternative systems, as discussed in Chapter 1 of this manual. Some of the criteria considered in selection of the deep foundation system for a project include:

1. **Cost.** All other items being equal, the lowest cost alternative should be selected in order that the resources (tax \$\$) of the project owner (the taxpaying public) are utilized most efficiently. It is important that the total overall foundation cost be considered when comparing alternatives, including the pilecap, cofferdam and seal footing.
2. **Schedule.** In some projects, there is such importance placed on the need to complete the project quickly that any schedule advantage of one type of deep foundation system may take precedence over the lowest cost alternative. Schedule impacts related to deep foundation construction may result in overall cost impacts to the project separately from the base cost of the foundation itself.
3. **Constructability.** Constructability and the risk of potential construction difficulties must be considered with each deep foundation alternative. Risks might also include risks of construction impacts to nearby structures.

In general, designers should identify more than one deep foundation alternate for consideration, at least through a preliminary design.

### **Block 7: Select Drilled Shaft Foundations for Further Evaluation**

At this point in the process, the discussion will be limited to drilled shaft foundations as the subject of this manual, although alternative deep foundation systems should normally be considered. For routine bridge projects, a common approach is to utilize a single drilled shaft to support each column. The most efficient shaft diameter and length are then determined following the process outlined in subsequent Blocks 8-15. As an alternative to single shaft supports, it may be more cost effective in some conditions to consider the use of groups of smaller diameter shafts with a cap. For earth retaining structures utilizing drilled shafts, it may be possible to consider secant or tangent piles, or some combination of drilled shafts with anchors, or drilled shafts below grade with a structural wall system above. For structures spanning long distances across variable conditions (such as retaining walls, sound walls, multiple light standards, etc.), it may be prudent to define separate sections of the project and consider different systems for different sections. If several deep foundation alternatives are considered, it is advisable to perform preliminary designs through Block 15 in order to evaluate the selection criteria described briefly in Block 6.

### **Block 8: Define Subsurface Profile for Analysis**

Based on the results of the subsurface investigation, a design subsurface profile with specific geomaterial properties must be established at each foundation location. In some cases it may be possible to group similar portions of the site for design purposes. For each design profile, it is also important that a potential range of geomaterial properties be identified so that the sensitivity of the design to each critical parameter can be evaluated during the design process. This evaluation for a range of conditions helps provide designers with the information to develop judgment and produce designs which can accommodate anticipated variability in site conditions. Note also that different subsurface profiles may be required for different design load cases, such as for extreme event conditions where full or partial scour may be considered, where seismic loads induce liquefaction in some layers, or where flood conditions may elevate pore water pressures and change the effective stress profile.

### **Block 9: Determine Resistance Factors for Design**

Resistance factors must be selected for strength and serviceability requirements for lateral, axial, and structural design with appropriate consideration of relevant factors as discussed in Chapters 12 through 15. In addition to calibrations to design methods, considerations include variability in geomaterial properties and stratigraphy, availability of site-specific load test data, redundancy, the extent of verification load testing, and other risk factors which may be identified by the designer based on judgment and experience.

### **Block 10: Establish Minimum Diameter and Depth for Lateral Loads**

This step is described in detail in Chapter 12, which includes a step by step flow chart of the components included in completing the design for lateral loading. Group effects for multiple shafts in a single foundation are described in detail in Chapter 14. In general, lateral load considerations for drilled shafts will determine a minimum shaft diameter, and so this step normally precedes the detailed design for axial loading in Block 11. In some designs, notably earth retaining structures, signs and high mast lighting, sound walls, and some bridges, lateral and overturning requirements may control the embedded length of the drilled shaft. In such cases, it is important to evaluate sensitivity to geomaterial properties and the individual components of resistance to lateral loading. If design for lateral loads proves to be the controlling factor in determination of shaft tip elevation, designers should evaluate the potential benefits and costs of lateral load testing.

### **Block 11: Establish Diameter and Depth for Axial Loads**

This step is described in detail in Chapters 13 and 14, which includes a step by step flow chart of the components included in computing axial resistance and completing the design for axial loading. Where groups of drilled shafts are used as a single foundation subject to overturning loads, the axial load demand for individual shafts are affected by the geometric layout of the shaft group. For typical bridge structures, the design for axial loading will determine the embedded length requirement and shaft tip elevation. Note also that the use of load testing should be considered to correlate axial resistance to geomaterial properties on a site-specific basis. An evaluation of the sensitivity of the design tip elevation to individual components of axial resistance (and resistance factors, which may be affected by availability of site-specific load test information) should be performed in order to evaluate the cost to benefit ratio of load testing.

### **Block 12: Finalize Structural Design of the Drilled Shafts and Connection to Structure (or Cap)**

This step is described in detail in Chapter 16, which includes a step by step flow chart of the components included in completing the structural design of the drilled shaft and connection to the column or cap. Note that some preliminary consideration of structural design (amount of longitudinal reinforcement) is typically included in Block 10, but the final detailed design of the reinforced concrete section is completed here in Block 12.

### **Block 13: Evaluate Constructability**

A consideration of possible methods of construction must be performed to ensure that a constructable design is produced. This task should include development of a possible step by step installation plan using the methods described in Chapters 4 through 9 of this manual. Elements of risk and/or likely



construction difficulties should be identified. During this process, designers should ask themselves, “how can the drilled shaft design be modified to minimize the risk of construction difficulties and still meet performance requirements in a cost-effective manner?” This exercise may also identify potential construction practices or sequence of work which could adversely affect performance for this specific project so that any such practices can be specifically excluded in the project special provisions. If modifications to the design are indicated or potential improvements identified, recycle through Blocks 10-12 or 6-12 as needed. An independent constructability review by an experienced person can be very valuable in this effort. Trade associations can be a valuable resource to provide constructability review by their subcontractor members through regional chapters located across the U.S.

#### **Block 14: Define Load Testing Program, if Included**

Load testing can provide extremely valuable information for site specific evaluation or verification of the design, and the use of load testing is a factor in the choice of resistance factors in Block 9. Consideration of the potential benefits and costs of load testing should be included in Blocks 10 and 11. If load testing is to be included in the project, designers must define a potential location on the site which is representative of typical subsurface conditions for the project as defined in Block 8. Details of the specific load testing program must address the specific components of resistance which are most important to the design, as identified by sensitivity studies in Blocks 10 and 11. Load testing is discussed in detail in Chapter 17 of this manual.

#### **Block 15: Estimate Costs**

A cost estimate should be prepared for the foundation as designed (including any alternate designs) with consideration of special constructability issues identified in Block 13 that may affect costs. In most cases, this block should also be included as a part of the project planning stage and during preliminary design when several alternates may be considered. During the final design process, this block will serve to include the engineer’s estimate of project cost prior to bid. Cost estimation is addressed in Chapter 22 of this manual.

#### **Block 16: Prepare Plans and Specifications**

As the design is finalized, plans and specifications can be prepared and the procedures that will be used to inspect and establish final tip elevation in the field can be defined. It is important that all of the quality control procedures are clearly defined for the bidders to avoid claims after construction is underway. If there are to be separate pay items for different components of work, these items must be defined in an unambiguous way in order to avoid disputes. Examples include payment for obstructions, earth excavation versus rock excavation, the use of permanent casing, etc.. If rock excavation is anticipated and is not defined as a separate pay item, then the amount of rock to be removed should be defined to the extent possible, including depth of rock sockets as well as the decomposed or fractured rock that may be removed but not considered part of the socket for design purposes. Note also that construction of drilled shafts is specialty construction work which requires a contractor or subcontractor with the appropriate equipment, skill and experience. Requirements for qualification or prequalification of foundation contractors should be included in bid documents. Requirements for contractor submittals and timelines for review of submittals must also be included in the contract documents. Specifications for drilled shafts are discussed in detail in Chapter 18 of this manual.

### **Block 17: Select Contractor with Appropriate Qualifications**

After the bidding process is complete, a successful contractor meeting the qualifications defined in Block 16 is selected.

### **Block 18: Evaluate Installation Plan and Concrete Mix Design**

Review of the contractor's drilled shaft installation plan by the designer (and often by an independent reviewer for large projects) is a critical component to successful construction of drilled shafts that are consistent with the design requirements. Constructability concerns that may have been identified in Block 13 should be addressed, and the coordination of inspection and quality control procedures (Block 16) with the proposed installation method should be defined. A preconstruction meeting is advised so that the designer, inspector, and contractor can review and discuss the most important issues.

### **Block 19: Observe and Evaluate Technique Shaft Installation**

A technique shaft installation should normally be performed as part of the project requirements prior to start of production shaft construction. The contractor should demonstrate by the technique shaft installation that the drilled shaft installation plan described in Block 18 is suitable for the project. If adjustments to the installation plan are required, additional review by the project designer is necessary.

### **Block 20: Observe and Evaluate Load Test Program**

If a load test program is included during the construction, installation of the test shaft(s) should normally occur after successful completion of the technique shaft installation in Block 19. It is also possible to use the technique shaft as a load test shaft, for cost reasons, particularly for projects involving large drilled shafts. It is important that the load test shaft be constructed in a manner and in a location that is representative of the production shafts, and inspection of the construction of this shaft must carefully note the actual conditions encountered. Results of the load test(s) should be evaluated by the designer for the purpose of evaluating the correlations of measured resistance with geomaterial properties used in the design. Adjustments to the final design and anticipated tip elevations may be made if justified by the load test data. It is important that the final design should include allowance for anticipated variations in stratigraphy and geomaterial properties across that site and that the load test results be interpreted with due consideration of the likely variations between foundation locations.

### **Block 21: Observe and Evaluate Construction of Production Shafts**

The procedures for observation, inspection, and documentation of construction of production shafts are defined in Block 16, modified if necessary in Blocks 18-20, and implemented in this Block. An important component of the inspection process is the communication between inspectors and the designer so that any unusual condition or problem can be addressed in a timely and efficient manner. A highly recommended practice is for the designer to be on-site during installation of the first production shaft and also for installation of the first drilled shaft installed in any set of different subsurface conditions. If defects are noted, the designer will need to assess the potential impact on the performance requirements, evaluate the need for remediation, and evaluate the effectiveness of any potential remediation of defects. The construction phase may also include a supplementary subsurface investigation; such a program may be necessary to explore locations not accessible during the design phase or to obtain site-specific

information for determination of socket elevations at each drilled shaft founded in rock. Inspection of drilled shaft installation is discussed in Chapter 19 and testing of completed drilled shafts is discussed in Chapter 20. Some strategies for assessment and repair of defects are described in Chapter 21 of this manual.

## **Block 22: Post-Construction Evaluation and Report**

A final report is sometimes prepared to document the foundation construction, any remediation that was necessary, and the final as-built conditions of the foundation. This documentation is important for future projects when rehabilitation or modification or replacement of the structure may be required. Well-constructed and documented foundations can often be incorporated into a new structure at the same location. In addition, since every project offers opportunities for lessons learned, documentation of the construction and testing can be a valuable reference for future projects in similar circumstances.

## **11.2 SUMMARY**

This chapter provides a roadmap of the overall design process, with a step by step description of the tasks to be completed. The individual steps may not always be performed in the linear fashion shown, and most of the time there will be several iterations of many of the individual steps through the process of planning and conceptual design, preliminary design, and final design. The precise order of the steps in the flow chart is not so important; rather, it is important that all of the steps in this checklist be completed. Some of the blocks in Figure 11-1 involving drilled shaft design are further subdivided into more detailed flow charts of the individual tasks. These are presented in Chapters 12 through 16, which cover the design steps in detail.

Archived

This page is intentional left blank.

## **CHAPTER 12**

### **DESIGN FOR LATERAL LOADING**

#### **12.1 INTRODUCTION**

Design for lateral loading typically controls the diameter of drilled shafts for highway bridges and may also control the embedded length for some types of structures such as retaining walls, noise walls, and sign or light standard foundations. Thus, an evaluation of lateral loading is required during planning and preliminary design. A more complete analysis of lateral loading conditions is required for final design including structural design; structural design of drilled shafts is covered in Chapter 16 of this manual. This chapter on design for lateral loading provides examples of applications in highway structures, presents significant concepts, and will address the details of standard and routine design of drilled shafts for lateral loading. A more rigorous coverage of analyses for lateral loading can be found in the FHWA publication "Handbook on Design of Piles and Drilled Shafts Under Lateral Load," by L.C. Reese, (1984). This manual does not explicitly address the design of drilled shaft foundations for seismic loading; however, many of the principles described in this chapter can be used for the determination of linear or nonlinear constraints (spring constants) for the bases of structural columns for the purpose of performing dynamic analysis of the structure. Additional discussion of issues relevant to the design of drilled shafts for seismic and other extreme event loads is provided in Chapter 15.

#### **12.2 EXAMPLES OF LATERAL LOADING**

The principal use of drilled shafts in highway projects is for supporting bridge piers and abutments, but they can also be used in the construction of retaining walls, overhead signs, sound walls and for slope retention. The lateral loads that are exerted on drilled shafts for highway structures are derived from earth pressures, centrifugal forces from moving vehicles, braking forces, wind loads, current forces from flowing water, wave forces in some unusual instances, ice loads, vessel impact and earthquakes. As discussed in Chapter 15, vessel impact and earthquake loads are viewed as "extreme events" with a probability of occurrence that exceeds the design life of the bridge. Even if none of the above sources of lateral loading are present, an analysis of a drilled shaft may be necessary to investigate the deformations and stresses that result within a drilled shaft from the intentional or unintentional eccentric application of axial load and from accidental batter. Examples of some cases in highway construction where drilled shafts are subjected to lateral loading are given in the following paragraphs. Analytical techniques are then described, along with examples of their use.

##### **12.2.1 Mon shaft Support for a Bridge Column**

Mon shaft (single drilled shaft supporting an individual column) supports offer advantages in the small footprint produced by the foundation for circumstances where the geometry of the structure, site access limitations or other factors discourage multiple columns and foundations. For aesthetic reasons, it is becoming more popular to use single columns instead of rows of columns in bents, especially for tall structures. Retrofitting and rehabilitation work or bridge widening may also dictate the use of single column support with mon shaft foundations. Mon shaft foundations are also often a more economical type of foundation in comparison to foundations with multiple elements and a pile cap. Figure 12-1 illustrates single-column bents which use a mon shaft foundation that is continuous with the column.



Figure 12-1 Single Column Piers with Monoshaft Foundations

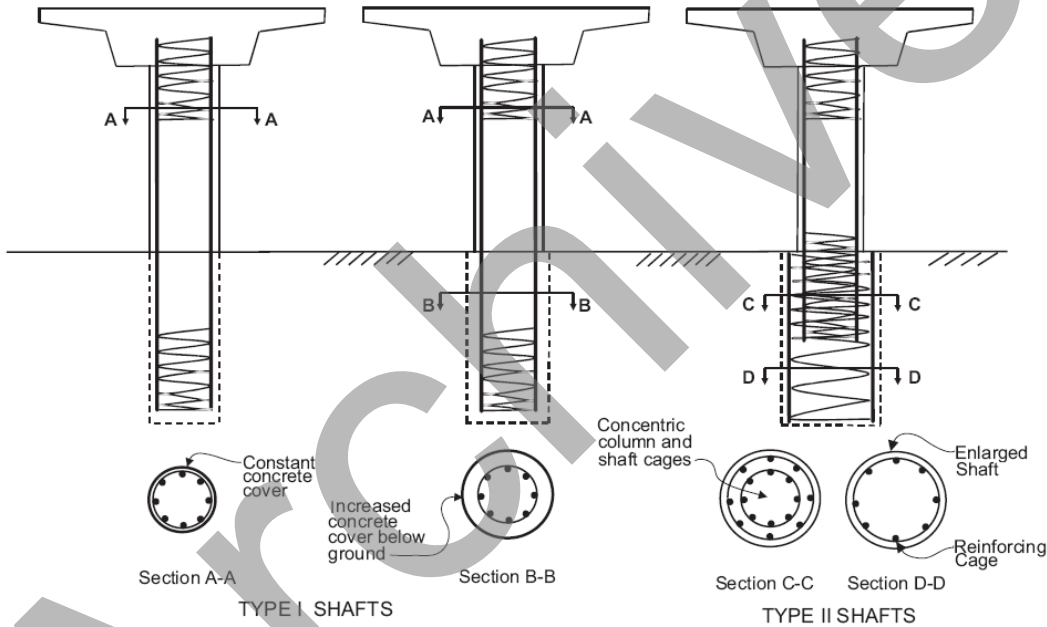


Figure 12-2 Monoshaft Foundations Used by Caltrans (Caltrans Seismic Design Criteria, Version 1.4, June, 2006)

Two approaches to the design of monoshaft foundations are typified by the “Type I” and “Type II” designs used by Caltrans and illustrated on Figure 12-2. The Type I foundation provides a continuous reinforcing cage from the drilled shaft to column so that the foundation is essentially an extension of the column into the subsurface. The Type II foundation includes a drilled shaft with a significantly larger diameter (at least 18 inches) and a larger reinforcing cage. This approach is intended to ensure that, should overstress in flexure occur during a seismic event, a plastic hinge would form at the base of the column / top of the shaft rather than at depth where inspection and/or repair would be more difficult.

### 12.2.2 Shaft Group Foundations for Bridge Structures

Where lateral (and/or vertical) loads are relatively large, groups of drilled shafts may provide a more efficient foundation solution, particularly where multiple columns may be supported on a single foundation. Groups of drilled shafts may also be needed to resist large lateral loads from vessel impact, seismic forces, ice load, or wind on high bridges that can produce large shear and overturning forces at the base of the column. If scour, liquefaction, or deep water conditions result in long unsupported shaft lengths, the lateral strength or stiffness of a mon shaft foundation may not be sufficient or may be impractical due to the large diameter shaft required. With a group of shafts connected by a common pile cap, the cap provides rotational restraint for lateral load at the top of the shaft, and transfers column bending moments into axial forces on the shafts. The force couples resulting from the axial resistance of separate shafts provides rotational strength and stiffness.

The diagram shown on Figure 12-3 illustrates a group of eight shafts used to support a pair of rectangular columns in a pattern similar to that used for the replacement bridge for the I-35W structure across the Mississippi River in Minneapolis. Each of the main piers for the pair of new bridges has two rectangular columns supporting a segmental box girder. The two columns are supported on a group of eight 7-ft diameter drilled shafts. The shafts are excavated through soils subject to scour and are embedded approximately 40 ft into a sandstone bearing stratum.

The basic principles for design of individual shafts within the group are described in this chapter. The design of groups of drilled shafts for combined lateral and axial loading is described in detail in Chapter 14 of this manual.

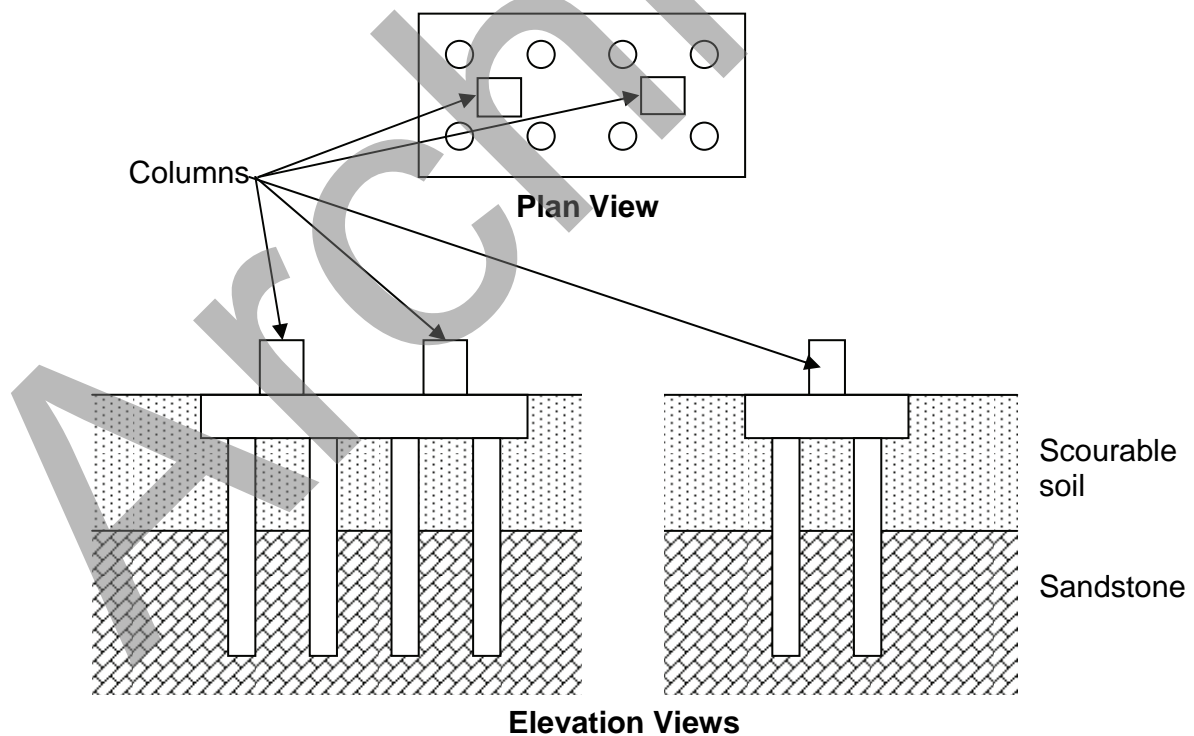


Figure 12-3 Example of a Drilled Shaft Group Foundation for a Bridge

### 12.2.3 Drilled-Shaft-Supported Bridge Over Water

A bridge over open water is subjected to lateral forces that include wind loads, current and wave forces, ship or barge impact, possibly seismic loads or ice loads, and centrifugal forces and braking forces resulting from traffic. Braking forces could be sizeable, especially if heavily-loaded trucks are suddenly brought to a stop on a downward-sloping span. It is also possible that the soil surface around the foundations could be lowered due to scour of soils from normal stream flow as well as from flood conditions and storm surge.

A bridge over water may often have relatively tall columns as shown on the example in Figure 12-4, and the height of the structure increases the overturning moment at the base of the column from wind, traffic, and seismic loads. Note the use of a strut between columns in Figure 12-4. A strut between columns can help engage the resistance of shafts supporting multiple columns for vessel impact loads.



Figure 12-4 Drilled Shafts for Bridge Over Water, Somerset, KY

### 12.2.4 Sound Walls, Sign Structures, High Mast Lighting

Sound walls, sign structures, and high mast lighting are examples of structures which are relatively lightly loaded in the vertical direction but subject to significant lateral shear and overturning moments due to wind. Wind loads act against the projected area of the structure, and wind gusts produce a force which is transient and often cyclic. Vehicle impact forces may also be significant design components in some instances. Figure 12-5 shows views of two types of foundations used for sign structures. Figure 12-5a shows a two-shaft foundation, and Figure 12-5b shows a single-shaft support. The two-shaft system resists the wind moment largely by added tension and compression (a "push-pull" couple) in the shafts, although some bending is required to resist the shear force, while the single-shaft foundation resists both the moment and shear produced by the wind load through bending.



Another characteristic of these types of structures is the fact that borings may be either widely spaced or infrequent so that the subsurface conditions at the location of an individual foundation element are known with less reliability than might be the case for a more substantial structure such as a bridge. In such a case, the designer must consider the potential variation in subsurface conditions for which a design might be used so as to accommodate a broad range of possible circumstances.

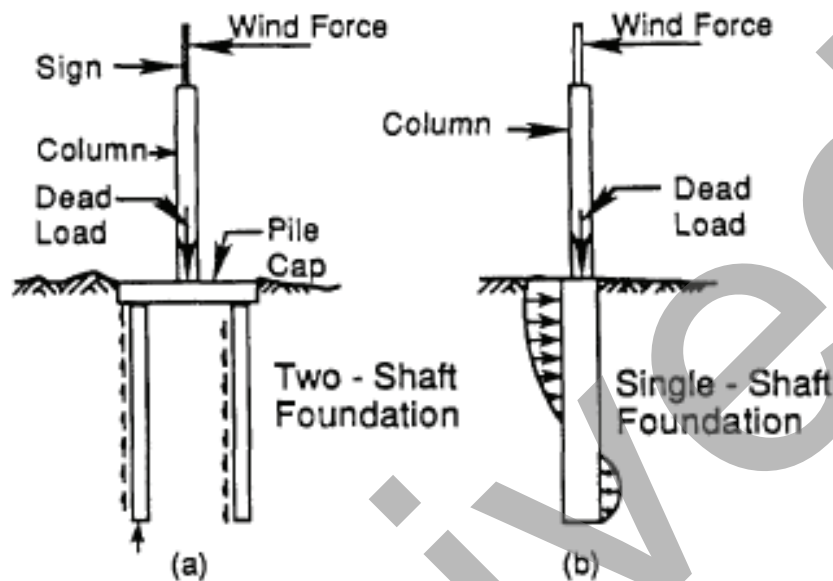


Figure 12-5 Elevation View of an Overhead Sign Structure: (a) Two-Shaft Foundation; (b) Single-Shaft Foundation (from *FHWA-IP-84-11*)

In a recent survey of hurricane wind damage to structures in Florida (Jones, 2005), the most commonly observed failure mode for sign foundations was due to structural failure in the anchor bolt connection at the top of the shaft. In at least some cases there were failures due to poor quality concrete at the top of the shaft or misalignment of the anchor bolts with the drilled shaft. The strength of this connection is typically the weak link (by design) in the system, but there is a need to ensure good workmanship in the placement of anchors and in the completion of the concrete placement.

### 12.2.5 Foundation for a Bridge Abutment

The lateral loadings acting on abutments result from soil pressures from the backfill acting on the abutment (which can be affected by settlement and/or lateral creep), braking forces that are transmitted through the deck system, thermal expansion or contraction of the bridge structure, seismic forces, and possibly other sources. Drilled shafts can carry large lateral loads because they can be installed with large diameters; their flexural strength is such that the loads from abutments can often be supported without the need to batter the shaft, as is commonly done for driven piles in order to resist lateral loads.

Figure 12-6 illustrates three different applications of drilled shafts for bridge abutments. Figure 12-6a shows a conventional cast-in-place concrete abutment founded on two rows of drilled shafts. This type of footing resists overturning of the abutment by the compression and tension loads developed in the outer and inner rows of drilled shafts. Figure 12-6b illustrates a spill-through or “stub” abutment which relies on a soil slope beneath the bridge structure to provide lateral support for the drilled shafts and to prevent

loss of soil from between the drilled shafts. The drilled shafts in Figure 12-6c are installed either directly against the adjoining drilled shafts (“tangent pile” wall) or slightly overlapping with the adjacent drilled shafts (“secant pile” wall). With either a spill-through abutment or a tangent/secant pile abutment, the drilled shafts resist the applied lateral loads in bending.

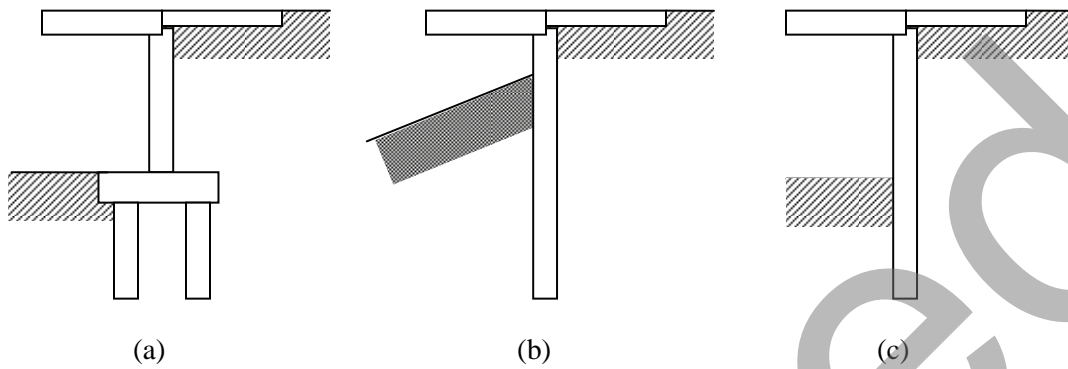


Figure 12-6 Sketch of Foundation for a Bridge Abutment



Figure 12-7 Drilled Shaft Abutment Foundations

The photographs of example abutments shown in Figure 12-7 also illustrate the use of drilled shafts to construct abutment walls. The tangent pile wall on the left will be covered with a curtain wall facing, and the drilled shafts for the abutment on the right will support a conventional abutment wall above grade.

Although the abutments described above are typically designed to resist lateral forces from the soil pressure behind the abutment, an arch bridge can also result in relatively large lateral thrust forces into the abutments. The arch bridge shown on Figure 12-8 includes thrust blocks designed to transmit the force from the arch into the abutment foundation, which is supported on drilled shafts.

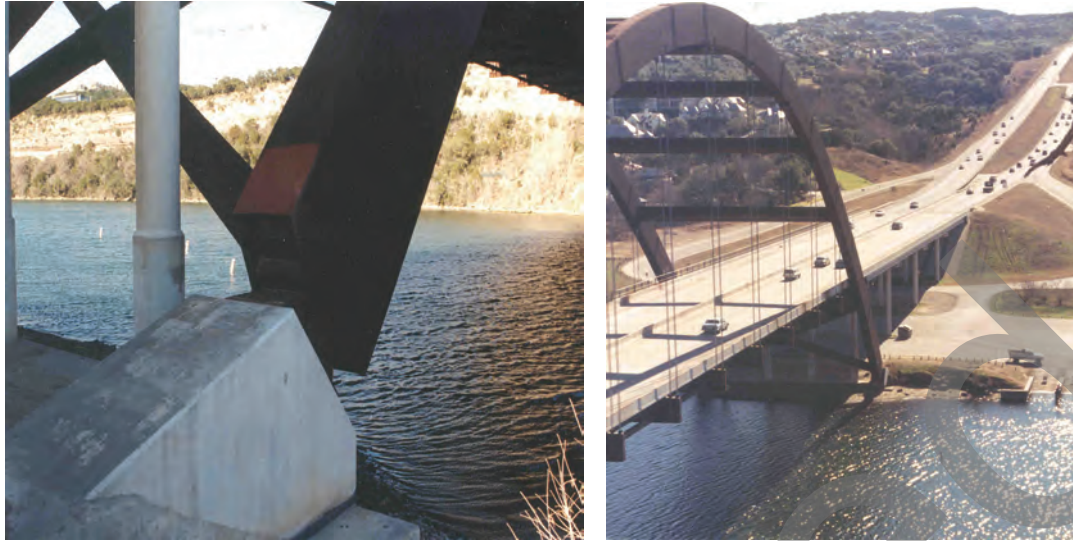


Figure 12-8 Arch Bridge (photograph courtesy of Ronald C. O'Neill)

### 12.2.6 Earth Retaining Structures

Drilled shafts may be used to construct earth retaining structures for highways either to form the wall itself or as foundation support for a conventional wall. Large diameter drilled shafts can be drilled vertically either with some overlap (secant pile wall) or immediately adjacent to one another (tangent wall) or at some finite spacing. If the depth of excavation in front of the wall of drilled shafts is too large for the shafts to carry the lateral loads as cantilevers, they can be tied back with anchors. Figure 12-9 illustrates a secant pile wall (Figure 12-9a) during construction, and a depressed section of highway in which the excavation has been retained by drilled shafts used as tangent piles (Figure 12-9b). Figure 12-10a provides a schematic of a retaining wall foundation on drilled shafts, in which the shafts are subject to lateral shear and overturning from the earth pressures on the precast panels of the wall above. Figure 12-10b shows such a wall under construction with the coated steel H beams extending up from the drilled shaft soldier piles; the panels have not yet been added and backfilled.



Figure 12-9 Drilled Shaft Retaining Walls: (a) Secant Wall; (b) Tangent Wall

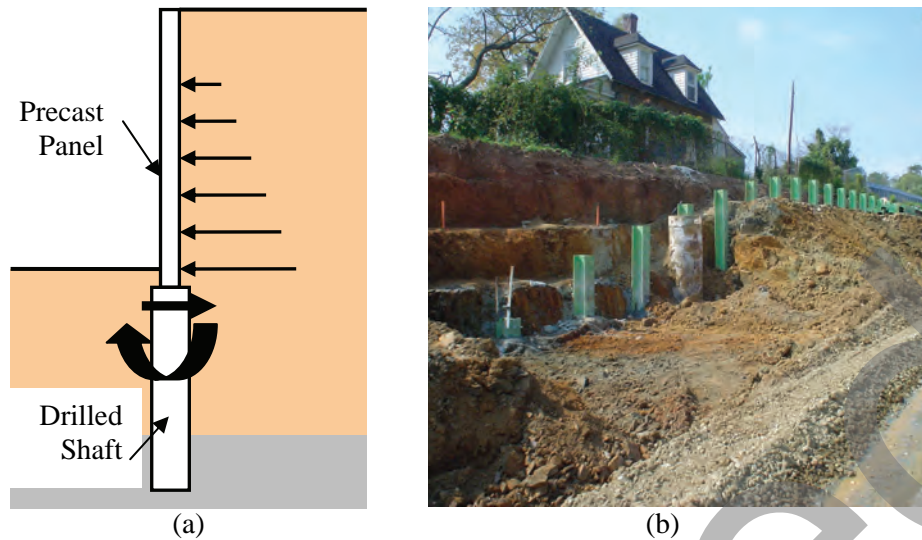


Figure 12-10 Drilled Shaft Foundation for a Retaining Wall using Soldier Piles and Precast Panels

### 12.2.7 Stabilization of a Moving Slope

Another use of drilled shafts to resist lateral loads is in problems of slope stability, as illustrated in Figure 12-11 and Figure 12-12. Some of the forces from the moving soil mass are transferred to the upper portions of the drilled shafts, which serves to increase the resisting forces in the soil, with a resulting increase in the factor of safety. The portion of a drilled shaft below the sliding surface must be designed to resist the applied forces without excessive deflection or bending moment.

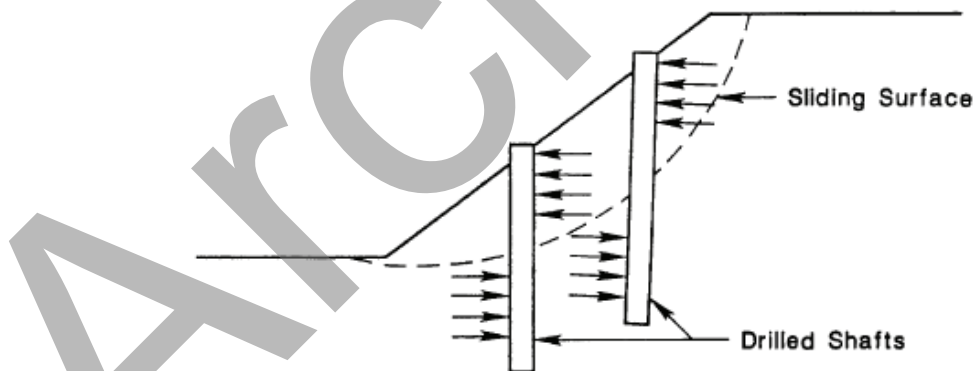


Figure 12-11 Drilled Shafts for Stabilizing a Slide (Reese et al., 1987)

Drilled shafts can provide several advantages as a means of stabilizing a slope. The construction of a drilled shaft will usually cause less soil disturbance than driving a pile. Crane-mounted drilling machines can be rigged so that the machine can sit above or below the slope and reach 80 ft or more horizontally to drill the shaft. Micropiles, anchors, and other types of deep foundations can also be used, but these more slender elements have less flexural strength and are installed so as to mobilize axial resistance.

A similar problem occurs with earthquake-induced lateral spreading due to liquefaction. With liquefaction, the soil resistance in the liquefied zone is affected by the transient and elevated pore water pressures. A soil layer which undergoes liquefaction produces a weak zone which can result in large lateral soil movements at the location of a drilled shaft foundation. The foundation may act to resist the lateral soil movements and thus stabilize the sliding mass, or the foundation may be simply subject to passive soil pressures as a “flow-around” type of movement occurs. Unless a liquefaction mitigation treatment is employed, the foundation must be designed to resist the effects of this extreme-event loading.

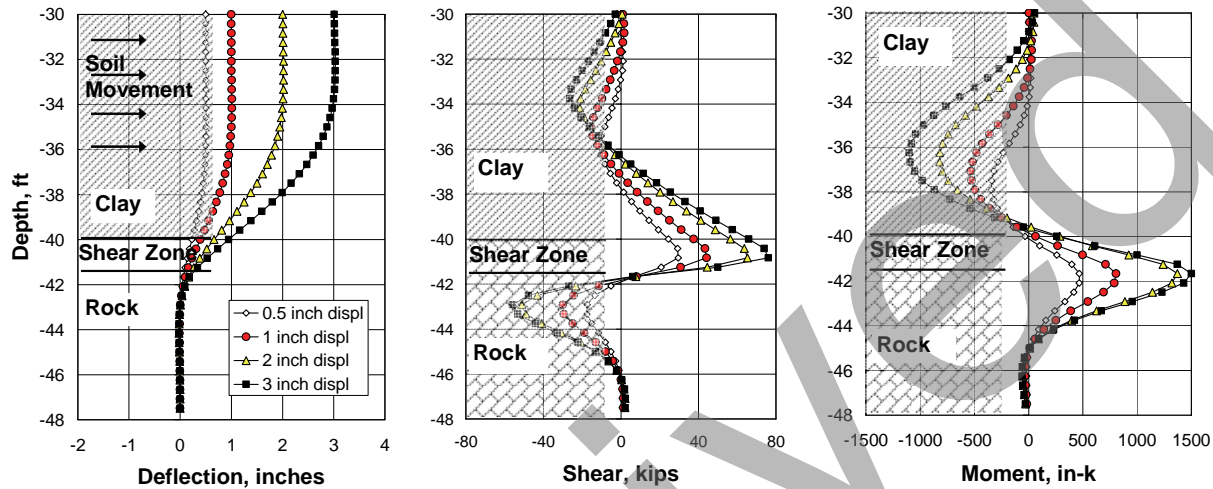


Figure 12-12 Analysis of Drilled Shafts in Moving Soil (Loehr and Brown, 2007)

## 12.3 DESIGN FOR LATERAL LOADING

### 12.3.1 Design Process

For lateral loading, the design can be controlled by geotechnical or structural strength requirements or by serviceability (deformation) conditions. These conditions are described as follows:

1. Geotechnical Strength Limit State (resistance of the shaft to overturning). The shaft should be of sufficient size and penetrate to sufficient depth to support the factored design loads without collapse. In general, deflections are not a controlling consideration for this condition; however, a computed deflection which is sufficient to cause collapse of other portions of the structure could represent a strength limit. The most critical lateral loading conditions affecting the geotechnical strength limit state are often associated with transient wind or extreme event load cases.
2. Structural Strength Limit State (strength of the shaft in flexure and shear). The shaft should be of sufficient size and constructed with the necessary reinforcement to resist the bending moment, shear and axial loads that will be imposed on the drilled shaft.
3. Service Limit State (deformations). The shaft should be of sufficient size and depth that the lateral deformations under service load conditions are within tolerable levels of the structure at the critical locations (typically at the top of the column). Design for lateral loading must include a determination of the deformations and/or stiffness of the drilled shaft in lateral translation and rotation so that the effects of foundation deformation can be considered in the analysis of the structure.

The design process for lateral loading is represented by Block 10 in the overall design process described in Chapter 11 of this manual. This block is subdivided to illustrate the process of design for lateral load on Figure 12-13.

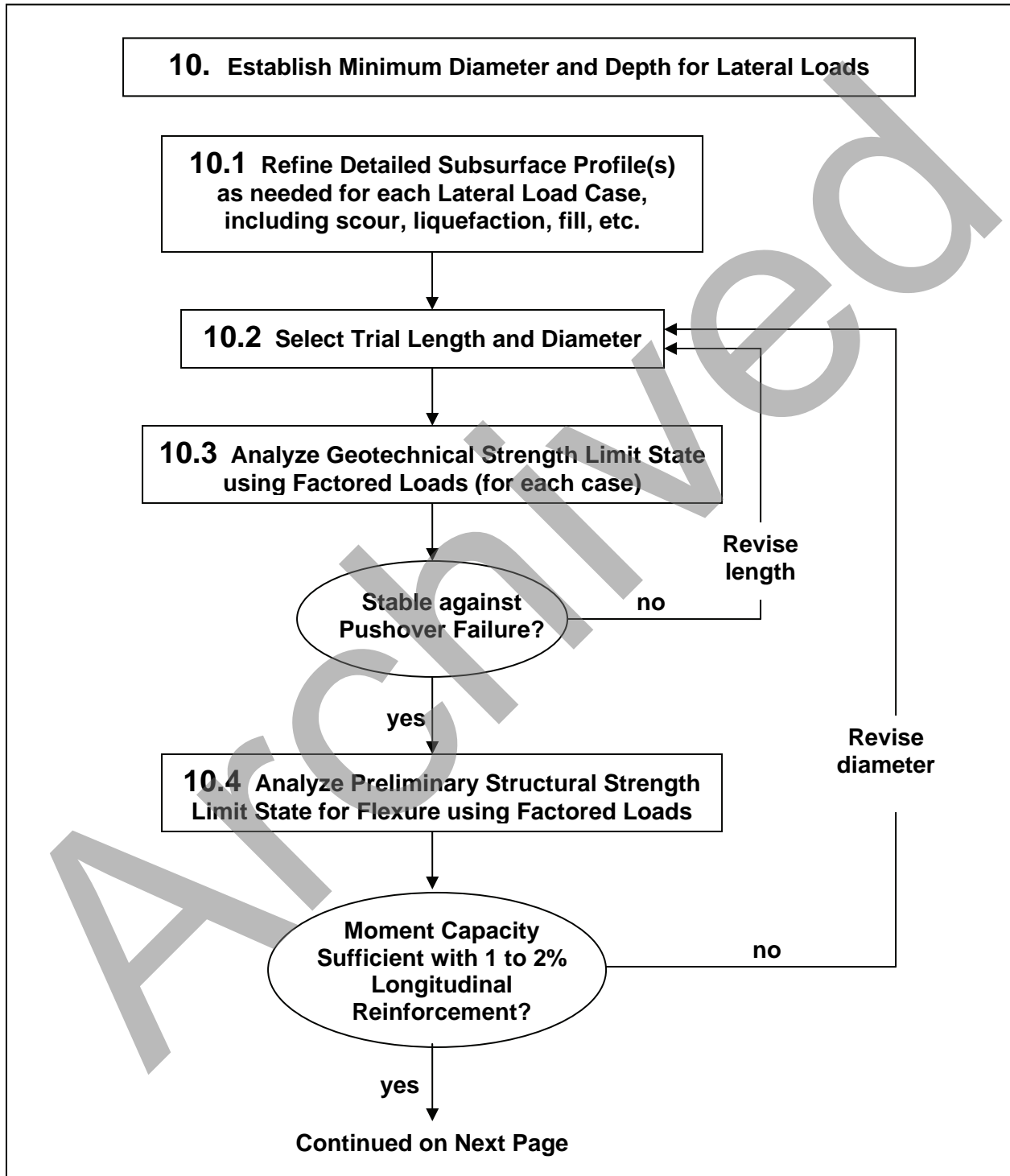


Figure 12-13 Drilled Shaft Design Process for Lateral Loads

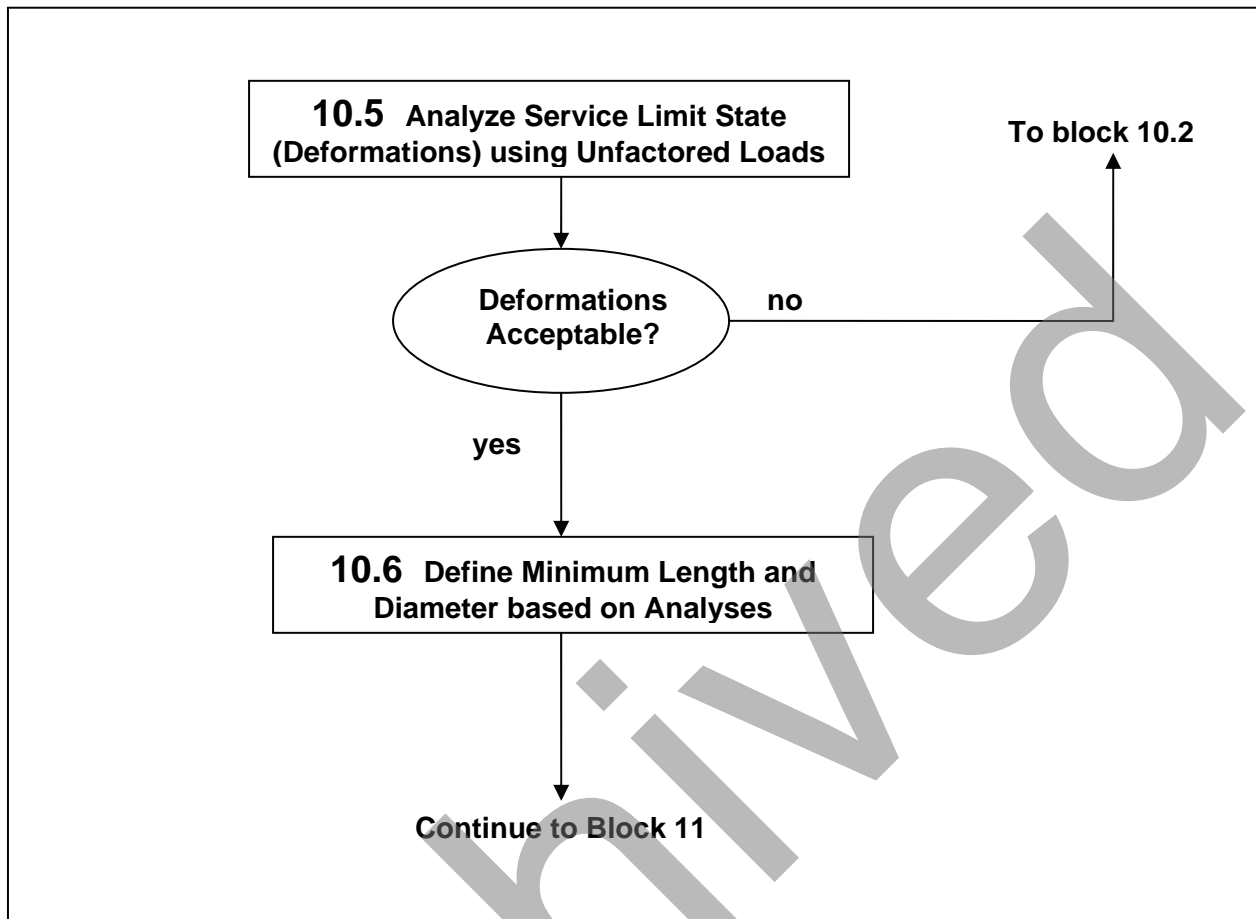


Figure 12-13 Drilled Shaft Design Process for Lateral Loads (Continued)

The information obtained in the site subsurface exploration and testing program described in Chapters 2 and 3 are used to develop a design subsurface profile for each lateral load case as required in Block 8 in Figure 11-1 of Chapter 11 and serves as the initial step (Block 10.1) for the design of the drilled shafts for lateral loads. The variability of geomaterial properties and strata elevations should be considered in developing a design profile. As a part of the subsequent design process, the designer will need to evaluate the sensitivity of the lateral load resistance to the various input parameters relating to the subsurface profile. In order to achieve a design that accommodates possible variability, it may be necessary to evaluate more than one design subsurface profile for a given foundation location.

Besides variation in stratigraphy across the site, different load cases may require different profiles because of the effects of scour or liquefaction. As described in Chapter 10, scour associated with the design flood affects the soil resistance for the strength limit states. Scour associated with the “check flood” is an extreme event design condition and is considered with different load and resistance factors. Lateral load considerations for the design scour and for extreme event loads and conditions are briefly described in Section 12.3.3.5 and discussed in more detail in Chapter 15.

The remainder of this chapter will focus on the design process for lateral loading for routine design, as outlined in Blocks 10.2 through 10.6. In order to design a drilled shaft for lateral loading, the engineer should have the capability to compute deflection and rotation at the head of the drilled shaft and the

maximum bending moment and shear force in the embedded drilled shaft. The engineer should also have the capability to compute the bending moment for a reinforced-concrete section at which a plastic hinge will develop, termed the nominal bending moment capacity. The nominal bending moment capacity depends on the magnitude of the axial force acting upon the drilled shaft. All of these factors depend to a large degree on the reaction provided by the soil or rock as the drilled shaft translates laterally beneath the ground, and on the relationship between bending moment and rotation of the drilled shaft cross section. Both of these inherently nonlinear effects are addressed in this section.

### **12.3.2 Planning Stage Estimates**

Lateral load considerations and flexural strength requirements often control the minimum shaft diameter. In cases of a single drilled shaft foundation for a single column, these strength requirements are often reflected in the column size. Preliminary shaft diameter is often set as slightly larger than that of the column. The longitudinal reinforcement may be continuous with the column (even though greater cover is typical for a drilled shaft than for a column) or the longitudinal reinforcement for the shaft may include a larger diameter cage to accommodate larger bending moments for the shaft relative to the column.

For single drilled shaft foundations, it is usually desirable to include a larger diameter drilled shaft even if the longitudinal reinforcement in the shaft will match that of the column. The cover on the reinforcement in the shaft can be designed to accommodate the typical 3 to 6-inch tolerance needed for the constructed location of the shaft and still allow the reinforcing to be positioned within the shaft excavation to line up with the column with the required minimum cover in the “as-built” condition.

#### **12.3.2.1 Preliminary Estimate of Maximum Bending Moments (Demand)**

To select a trial diameter and length in Block 10.2, it is helpful to perform a very simple preliminary analysis for structural strength and estimate the approximate maximum bending moment in the shaft. An estimate of factored loads at the top of the shaft is required to perform the preliminary analysis. The structural design of a typical bridge structure is conducted using some type of frame analysis, with force effects resolved at the top of shaft or near the ground line as was illustrated in Figure 10-2. Ground line forces from signs, light standards, sound walls, and similar are usually computed using simple statics.

For preliminary design, a simple first estimate of maximum bending moments in the shaft below grade can often be performed by modeling the shaft below grade as a free-standing column of some length, which is fixed at the base. Although there exist many misconceptions among engineers regarding the concept (often referred to as a “point of fixity”), the concept can be used effectively for preliminary design if the limitations are understood. In essence, the more realistic nonlinear model of the shaft as a beam with nonlinear springs used to model the soil resistance along its length (described subsequently) is replaced by a simple equivalent linear system composed of a free-standing cantilever beam which is fixed at the base (Figure 12-14). The results of simple analyses using a p-y model (described subsequently) suggest that the equivalent cantilever lengths presented in Figure 12-15 would provide an estimate of maximum bending moment in the shaft which is approximately equal to that computed using a more sophisticated model.



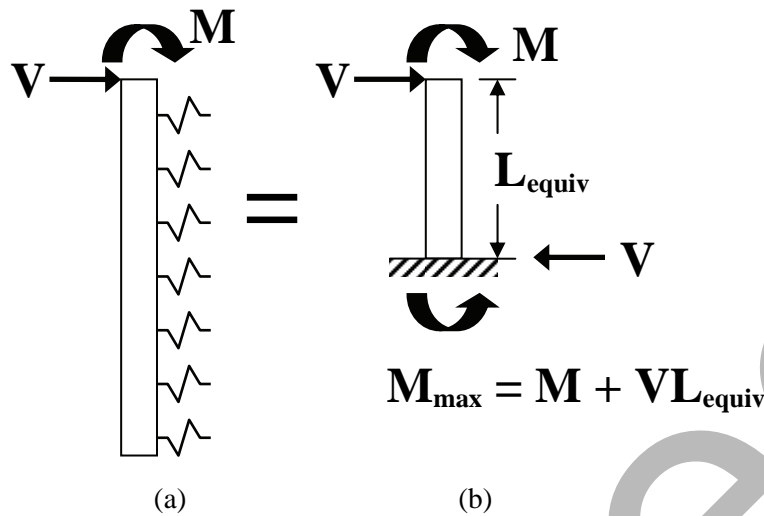


Figure 12-14 Equivalent Length Concept for Preliminary Design: (a) Nonlinear p-y Analysis; (b) Simplified, Point-of-Fixity Model

Figure 12-15 provides an equivalent length, expressed in shaft diameters, which may be used to compute the maximum bending moment in the shaft below grade as outlined on Figure 12-14. Note that the maximum bending moment does not necessarily occur at a point below grade corresponding to  $L_{\text{equiv}}$ . This model is simply an approximation to estimate maximum bending moments in the shaft for preliminary design; there is really no such thing as a “point of fixity”.

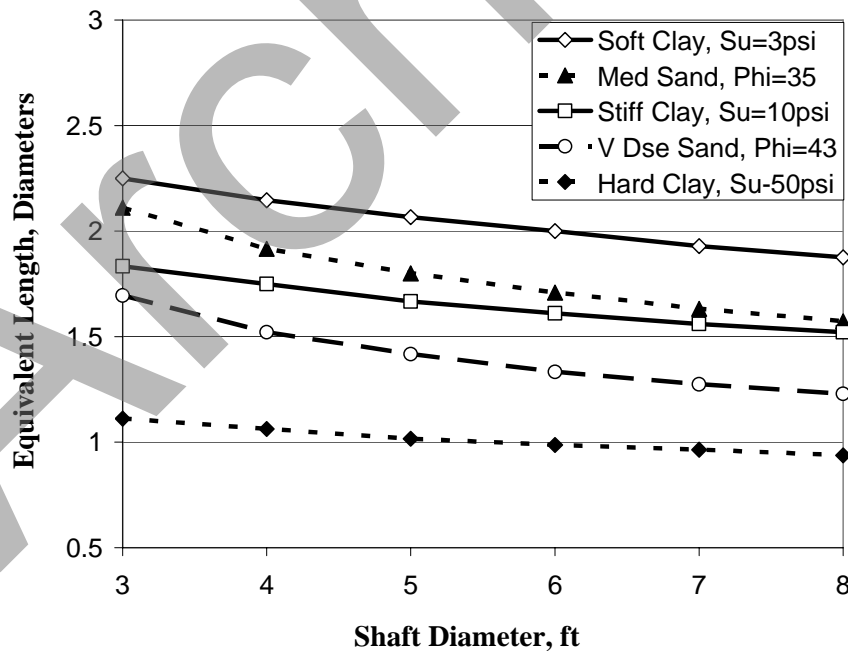


Figure 12-15 Equivalent Length of Shaft for Preliminary Design of Single Shaft Foundation (for estimating maximum bending moment only)

The values shown on Figure 12-15 have been computed for uniform deposits of clays ranging from soft to hard (undrained shear strengths of 3 to 50 psi) and for medium to very dense sands ( $\phi$  ranging from 35° to 43°). This range of values should provide designers with a sense of the potential range in the magnitude of the maximum bending moments sufficient for planning or preliminary design purposes. Very hard materials such as rock would be expected to have an effective equivalent length for this purpose of less than one shaft diameter.

The equivalent drilled shaft lengths determined from Figure 12-15 will only provide an estimate of the maximum bending moment generated in the drilled shaft. This chart is for preliminary analysis of structural strength demand and should not be used to estimate drilled shaft displacement or rotation for serviceability conditions. An example of the use of this chart follows in Section 12.3.2.3.

### 12.3.2.2 Estimating Nominal Bending Moment Resistance

Structural design of drilled shafts is described in detail in Chapter 16 of this manual, and follows the provisions of AASHTO 5.7.4 for reinforced concrete columns. However, for selection of a trial shaft diameter in Block 10.2, it is helpful to make a preliminary estimate of nominal bending moment resistance.

For planning purposes, preliminary sizing of drilled shafts can be estimated using the following *approximate* values of nominal bending moment capacity:

1. For shafts with longitudinal reinforcing equal to approximately 1% of the gross cross sectional area,  $M_n, \text{ k-ft} \approx 27 D^3$
2. For shafts with longitudinal reinforcing equal to approximately 1.5% of the gross cross sectional area,  $M_n, \text{ k-ft} \approx 40 D^3$

Where:

- D = Shaft diameter in ft.  
M<sub>n</sub> = The nominal bending moment resistance of a circular reinforced column with 3 inches cover and no axial compression load applied.

Nonzero axial compression forces generally increase the nominal bending moment capacity for tension controlled members (strength conditions dominated by flexure rather than axial compression), so the above estimates are likely to be conservative for most cases.

For structural design of the drilled shaft, the nominal strength in flexure ( $M_n$ ) times a resistance factor ( $\phi$ ) must exceed the computed bending moments produced from the factored design loads, i.e.  $M_{\max} \leq \phi M_n$ . The resistance factor ( $\phi$ ) for columns under combined axial and bending (outlined in AASHTO 5.5.4.2) ranges from 0.75 to 0.9, with the value of 0.9 typically governing in those cases dominated by flexure. A complete discussion of drilled shaft design for structural strength is provided in Chapter 16.

### 12.3.2.3 Example of Preliminary Analysis for Lateral Loading

As an example of the use of the approach outlined above for preliminary selection of shaft diameter, consider a column foundation which is subject to a lateral shear force (factored load) at the ground line of 40 kips combined with an applied factored overturning moment of 800 kip-ft. The single drilled shaft will be embedded into a very stiff clay soil, with an undrained shear strength estimated to be 15 psi.

As a first estimate (Step 10.2), consider a shaft with a diameter of 4 ft. Figure 12-15 would suggest an equivalent length of 1.5 to 1.7 diameters, or 6.0 to 6.8 ft, and thus an approximate maximum bending moment would be in the range of  $800 \text{ k-ft} + (6.8 \text{ ft})(40 \text{ k}) = 1072 \text{ k-ft}$ . A 4-ft diameter shaft with 1% reinforcing is expected to have a factored bending moment capacity of at least  $(0.9)(27)(4)^3 = 1555 \text{ k-ft}$ , well in excess of the 1072 k-ft required (Step 10.4).

Using the 1072 k-ft as roughly equal to the required factored moment capacity, the minimum diameter can be estimated as  $D = \{1072/[(0.9)(27)]\}^{1/3} = 3.53 \text{ ft}$ . Therefore a shaft in the range of 3.5 ft to 4 ft diameter is likely to be sufficient and may be considered for complete design as described subsequently.

### 12.3.3 Computational Procedures and Design Methodology

In order to complete the design of a drilled shaft for lateral loading outlined in Blocks 10.3 through 10.5, the engineer must:

- (a) compute geotechnical resistance to overturning of the shaft (Block 10.3),
- (b) compute the maximum bending moment and shear force in the embedded drilled shaft (Block 10.4),
- (c) compute the nominal moment capacity of the shaft (Block 10.4), and
- (d) compute deflection and rotation at the head of the drilled shaft (Block 10.5).

The reaction provided by the soil or rock influences each of these steps in the process.

The recommended methodology for computing the response of drilled shafts to lateral and overturning forces is the “p-y method” which models the shaft as a nonlinear elastic beam and uses a series of nonlinear springs to model the soil resistance. This model has been found to capture the essential mechanisms of the problem, and has a history of successful use in both transportation and offshore foundation engineering. There are several computer codes available for implementation of this model. A general description of the p-y method is presented in the following section.

Alternative methods include simple hand solutions (e.g., Broms, 1964a, 1964b, 1965), limit equilibrium solutions combined with beam-on-elastic-foundation (BEF) models such as “strain-wedge”, elastic continuum solutions, and nonlinear finite element models. A brief description of alternative models is presented in Section 12.3.4.

#### 12.3.3.1 General Description of the p-y Method

The “p-y Method” represents a relatively sophisticated model which can effectively capture the nonlinear aspects of the problem, and is the recommended method for design of drilled shafts for lateral loading. This approach is readily implemented using one of several available computer software packages. The basic principles are described below.

The p-y method is a general method for analyzing laterally loaded piles and drilled shafts with combined axial and lateral loads, including distributed loads along the pile or shaft caused by flowing water or creeping soil, nonlinear bending characteristics, including cracked sections, layered soils and/or rock and nonlinear soil response. This method has an established history of use in highway and offshore foundation engineering applications and is recommended for use in complete design of foundations for transportation

structures. It requires the use of a computer, but available software is user-friendly and straightforward to apply. The essence of the method is presented here, and the reader is referred to two FHWA documents that will give further information for application of the method to foundation design: "Handbook on Design of Piles and Drilled Shafts Under Lateral Load" by L.C. Reese, FHWA-IP-84-11, July 1984, and "Behavior of Piles and Pile Groups Under Lateral Loads" by L.C. Reese, FHWA-RD-85-106, March 1986.

Research funded by FHWA lead to the development of the computer program "COM624", which was widely used in the 1980's. This was a DOS-based program written in FORTRAN. COM624 has not been upgraded or maintained since 1987, does not have all of the features and soil models that are now available, and has been replaced by commercial software that is easy to use with current operating systems. The two most widely used software packages in DOT offices are "LPILE" developed by Ensoft, Inc. of Austin, Texas, and "FBPIER" developed by the Bridge Software Institute of Gainesville, FL. Both of these codes use similar formulations for the lateral soil resistance. Other codes are also available. Another recent development is the implementation of the "strain wedge method" implemented in a code "DFSAP" and available through Washington DOT. This method provides an alternative formulation for the lateral soil resistance.

The application of lateral load to a drilled shaft must result in some lateral deflection. This deflection causes a soil reaction that acts in a direction opposite to the deflection; i.e., the soil pushes back. The magnitude of the soil reaction along the length of the drilled shaft is a nonlinear function of the deflection, and the deflection is dependent on the soil reaction. The "p-y" method is so named because the soil resistance is modeled as a nonlinear spring in which the force due to soil resistance,  $p$ , develops as a function of deflection,  $y$ , and the relations between the two are modeled as p-y curves.

Thus, determining the behavior of the drilled shaft under lateral loading involves the solution of a soil-structure interaction problem. Two conditions must be satisfied: the equations of equilibrium of the drilled shaft and compatibility between deflection and soil reaction. A solution would have been quite difficult in the past but computers, user-friendly software and the availability of results of full-scale experiments on which to base p-y criteria now permit answers to be obtained routinely.

A physical model for the laterally-loaded drilled shaft is shown in Figure 12-16. A drilled shaft is shown in the figure with loadings at the top. The soil has been replaced with a series of mechanisms that show the soil response in concept. At each depth,  $x$ , the soil reaction,  $p$  (resisting force per unit length along the drilled shaft), is a nonlinear function of lateral deflection,  $y$ , and is defined by a curve that reflects the shear strength of the soil, its Young's modulus, the position of the piezometric surface, the drilled shaft diameter, depth and whether the loading is static (monotonic) or cyclic. Bilinear curves are shown in this figure, but actual p-y curves are usually more complex.

The methods of representing the p-y curves for a variety of soils are cited below after presenting the governing equations.

The drilled shaft itself is treated as a beam-column with lateral soil support. The general behavior of the drilled shaft under a combination of lateral and axial loading can be obtained by solving the following differential equation (Hetenyi, 1946):

$$EI \frac{d^4 y}{dx^4} + P_x \frac{d^2 y}{dx^2} - p - w = 0 \quad 12-1$$

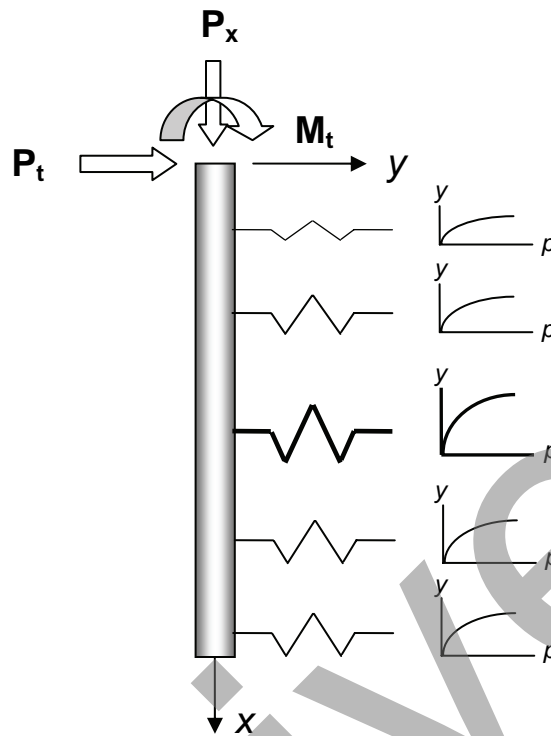


Figure 12-16 Model of a Drilled Shaft Foundation Under Lateral Loading Showing Concept of Soil Response Curves

Where:

- $P_x$  = Axial load on the shaft,
- $y$  = Lateral deflection of the shaft at a point  $x$  along the length of the shaft
- $p$  = Lateral soil reaction per unit length
- $EI$  = Flexural stiffness of the drilled shaft
- $w$  = Distributed load along the length of the shaft, if any

The software that is used to solve Equation 12-1 also includes the various boundary conditions that occur at the top and bottom of the shaft. For example, the applied moment and shear at the shaft head can be specified, and the moment and shear at the base of the drilled shaft can be taken to be zero if the shaft is long. For shorter shafts, a base boundary condition can be specified that allows for the imposition of a shear reaction on the base as a function of lateral base deflection. Full or partial head restraint can also be specified. The flexural stiffness of the shaft,  $EI$ , can be modeled as a nonlinear function of bending moment along the length of the shaft to account for cracking in the reinforced concrete cross section.

Other beam formulae necessary in the analysis are:

$$EI \frac{d^3 y}{dx^3} = V \quad 12-2$$

$$EI \frac{d^2 y}{dx^2} = M \quad 12-3$$

$$\frac{dy}{dx} = S \quad 12-4$$

Where:

$V$	=	Transverse shear in the drilled shaft
$M$	=	Bending moment in the drilled shaft
$S$	=	Slope of the deflection diagram.

The derivation of these equations is described in Chapter 2 of FHWA-RD-85-106 (Reese, 1986).

The axial load,  $P_x$  is included in the differential equation because of its influence on bending moments and lateral deflections. Equation 12-1 is therefore a beam-column equation that can be used to investigate buckling as well as bending. The analysis is described in general terms below:

The soil resistance,  $p$ , in Equation 12-1 is considered to be a function of the deflection,  $y$ , and thus Equation 12-1 is a differential equation in terms of a single variable. The nonlinear relationship between the soil resistance,  $p$ , and the deflection,  $y$ , is the  $p$ - $y$  curve used to model the soil. In order to model a nonlinear  $p$ - $y$  curve, a equivalent linear secant modulus is assumed and the numerical solution obtained by successive approximation and iteration until convergence as described below. The slope of a secant to any  $p$ - $y$  curve is defined as follows:

$$E_s = p/y \quad 12-5$$

Where:

$E_s$  = Soil modulus (a function of  $y$  and  $x$  with units of  $F/L^2$ )

Equation 12-5 is substituted into Equation 12-1, and the resulting equation is formulated as a numerical solution with the shaft or pile discretized into a number of points, or nodes, along the drilled shaft. The value of  $p$  at each node,  $i$ , is expressed as  $E_{s_{yi}}$ , so that the unknowns in the problem become the  $y$  values at all of the nodes. A computer solution, which involves the simultaneous solution of a series of equations numerous times, proceeds as follows:

1. A deflected shape of the drilled shaft is assumed by the computer.
2. The  $p$ - $y$  curves are entered with the deflections, and a set of  $E_s$  values is obtained.
3. With the  $E_{si}$  and  $Y_{si}$  values the difference equations are solved for a new set of deflections.
4. Steps 2 and 3 are repeated until the deflections computed at all nodes are within a specified tolerance of the values from the previous set of computations (iteration).
5. Bending moment, shear, and other aspects of the behavior of the drilled shaft are then computed from numerical solutions of Equations 12-2 through 12-4, and both tabular and graphical outputs of the shear, moment, slope and soil resistance diagrams can be displayed.

The numerical solution of the governing equations may be accomplished using either a finite difference solution or a finite element approach. Both numerical solutions should give identical answers if the number of nodes and other parameters are the same and the iteration tolerance is sufficiently small.

The procedure described above is dependent on being able to represent the response of the soil by an appropriate family of p-y curves. Full-scale experiments and theory have been used and recommendations have been presented for obtaining p-y curves, both for static and for cyclic loading. Detailed descriptions of available p-y models (as of 1985) are provided in FHWA-RD-85-106 (Reese, 1986). These models have been programmed as subroutines to computer programs, and the user merely needs to input the loadings, the section geometry of the drilled shaft and its stiffness, and the soil, steel and concrete properties. Other p-y methods can also be specified (e.g., Murchison and O'Neill, 1984, the API method for sands; Reese, 1997, an updated method for rock based on analysis of loading tests), and additional relations will likely be added as research and field experiments allow for their development. Site-specific p-y relationships as obtained from field loading tests can also be input by the user. Application of cyclic p-y criteria are important for situations in which the loading is cyclic, such as wave loading, wind loading and loading from seismic events, since the geomaterial will weaken compared to cases in which the loading is constant. Section 12.3.3.4 provides general design guidelines using currently available p-y models. Section 12.3.3.5 provides guidelines on selection of the appropriate p-y model for a range of geotechnical conditions.

The computer programs provide an opportunity for investigating the influence of a large number of parameters with a minimum of difficulty. Some of these factors are the loading; the geometry, stiffness, and penetration of the drilled shaft; soil properties; and the interaction between the drilled shaft and the superstructure. In addition, if an unsupported portion of the drilled shaft extends above the groundline, buckling can be easily studied.

One of the most appropriate uses of the programs is to investigate the effects of drilled shaft penetration on performance. For a given system of loads, the penetration of the shaft can be varied and the lateral deflection of the head can be determined as a function of penetration. For "short" and "intermediate" length shafts, the lateral deflection will vary considerably with changes in penetration, but as the shaft becomes "long," penetration will have essentially no effect on lateral displacement.

The presence of a tieback or strut can be simulated by means of a very stiff p-y curve, representing the axial stiffness of the support, at the location of the support. That curve is merely input along with the p-y curves for the soil. As briefly described in Section 12.3.6, p-y curves can also be offset by a specified displacement with respect to the drilled shaft, with the result that the soil resistance forces are mobilized against the drilled shaft in order to simulate an active pressure condition.

### **12.3.3.2 Simulation of Nonlinear Bending in Drilled Shafts**

#### **12.3.3.2.1 General**

For design of drilled shafts under lateral loading, the engineer must recognize that the shaft is essentially a reinforced concrete beam-column and that its bending behavior cannot always be appropriately represented by a simple linear elastic beam, that is, by a single EI value. If the purpose of the analysis is to determine moments and shears within the shaft in order to design the reinforcing steel and to obtain the appropriate diameter, a linear analysis will almost always be sufficient. But, if the purpose of the analysis is to estimate deflections and rotations of the head of the shaft, nonlinear bending should be considered.

With regard to structural design of the shaft (covered in detail in Chapter 16), the amount and placement of the reinforcing steel must be sufficient to satisfy the moment demand for the structural limit state. Some bending moments are also caused by the unavoidable eccentricity of axial loads; however, such moments are dissipated within the top few diameters of the drilled shaft, even when the surface soils are relatively weak. When designing reinforcing cages, therefore, it is recommended that a method be used that will produce the moment and shear diagrams under the critical combination of factored loads, including axial loads applied at the bounds of the eccentricity permitted by the construction specifications. The reinforcing steel cage can then be designed rationally, including a reduction in the amount of longitudinal reinforcement with increasing depth of the drilled shaft. The p-y method is well-suited for this type of analysis.

### 12.3.3.2.2 Computation of Ultimate Bending Moment Capacity and Bending Stiffness.

Concepts: As the bending moment on any reinforced concrete section increases to the point at which it produces tensile stresses on one side of the shaft that exceed the tensile strength of the concrete, the section will crack, and a dramatic reduction in the EI of the section at that point will occur. Since the concentric axial component of load (if compressive) produces uniform compressive stresses across the section that superimpose upon the bending stresses, the moment at which cracking occurs is a function of the magnitude of axial load on the drilled shaft. The assumption normally made is that cracks will be closely spaced along segments of the shaft in which the net tensile stress exceeds the tensile strength of the concrete.

Stress-Strain of Concrete and Steel: Nonlinear stress-strain curves are used for both steel and concrete. It is assumed that compressive collapse occurs in the concrete at the ultimate value of normal strain,  $\epsilon_c$ , of approximately 0.003; for steel, the ultimate value of strain in both tension and compression is taken as 0.0020. The tensile strength of the concrete  $f_r$  is taken as  $7.5\sqrt{f_c'}$ ; here  $f_r$  and  $f_c'$  (compressive strength) are both in units of lbs/sq.in. (psi), and the stress-strain behavior of the concrete in tension is assumed to be linear up to that stress.

Moment Curvature Relation: The derivation of the relation between bending moment, axial load and EI proceeds by assuming that plane sections in a beam-column remain plane after loading (Reese et al., 1998). Thus, when an axial load,  $P_x$ , and a bending moment,  $M$ , are applied, the neutral axis will be displaced from the center of gravity of a symmetrical section. The equilibrium equations for such a condition can be expressed as follows, where  $\sigma$  is a stress normal to the section.

$$b \int_{h_2}^{h_1} \sigma dy = P_x \quad 12-6$$

$$b \int_{h_2}^{h_1} \sigma y dy = M \quad 12-7$$

The terms used in the above equations are defined in Figure 12-17.



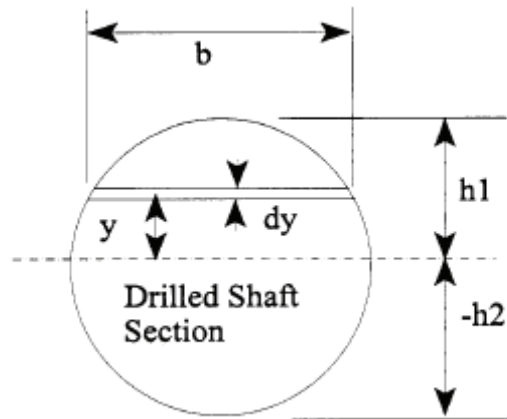


Figure 12-17 Definition of Terms in Equations 12-6 and 12-7

The numerical procedure for determining the relation between axial load, bending moment and EI of the section, considering the nonlinear stress-strain properties of the concrete and steel, is as follows for compressive axial loading and applied bending moment.

- A position of the neutral axis is estimated and a strain gradient,  $\phi_e$ , across the section about the neutral axis is selected.  $\phi_e$  is defined such that the product of  $\phi_e$  and distance from the neutral axis gives the strain at a specific distance from the neutral axis.  $\phi_e$  has units of strain / length and is assumed to be constant, whether the section is in an elastic or an inelastic state. This defines the strain at every point in the section.
- Knowing the strain distribution across the section and the stress-strain relations for the steel and concrete, the distribution of stresses ( $\sigma$ ) across the cross-section are computed numerically.
- The axial load acting upon the section is the integral of all of the compressive and tensile normal stresses acting on the section over the area of the section (Equation 12-6). If the value of computed axial load does not equal the applied axial load ( $P_x$ ), the position of the neutral axis is moved and the computations are repeated. This process is continued until the computed value of P is equal to the applied value of  $P_x$ .
- The bending moment associated with this condition is then computed by summing moments from the normal stresses in the cross-section about a convenient point in the section (e.g., the centroidal axis or the neutral axis, Equation 12-7).
- The EI value for this particular stress state in the cross section, which is associated with particular values of axial load  $P_x$  and bending moment M, then remains to be determined.
- It can be shown from beam mechanics theory that  $EI = M / \phi_e$ , where  $\phi_e$  is the curvature (rate of change of slope) of the beam. Therefore, a unique relationship between  $P_x$ , M and EI is found for any particular section considering the number and placement of steel bars, the compressive strength of the concrete (and therefore its tensile strength) and the yield strength of the steel. The process is repeated for different values of  $\phi_e$ , so that a complete relationship between M and EI can be obtained for a given value of  $P_x$ . An example of such a relationship for two different values of  $P_x$  is given in Figure 12-18.

Figure 12-18 illustrates the effect of the axial load,  $P_x$ , on the relationship between M and EI. The presence of a compressive axial load stiffens the section by retarding the onset of cracking. In this particular example the EI at the nominal moment is also higher when the compressive axial load is applied.

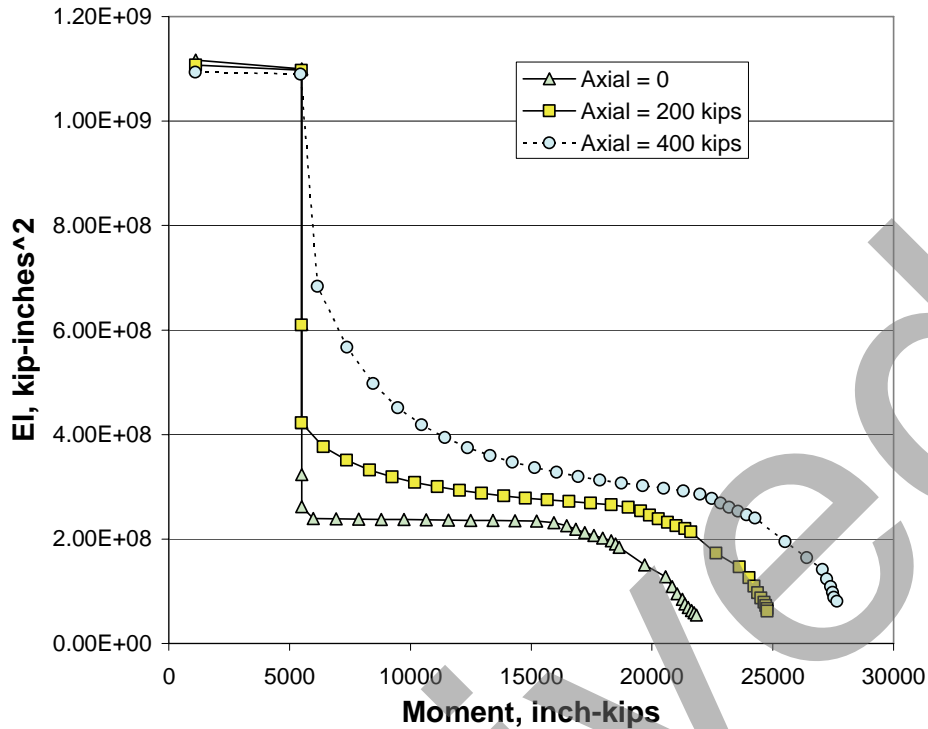


Figure 12-18 Variation of EI of a Drilled Shaft Cross Section with Bending Moment and Axial Load (4 ft diameter shaft with 12 #11 bars, 3 inches cover)

The stress-strain curves that were used in COM624 and are used in current software are shown in Figure 12-19 and Figure 12-20 for concrete and steel, respectively.

Referring to Figure 12-19:

$$f_c'' = 0.85f_c' \quad 12-8$$

$$E_c (\text{initial slope of stress - strain curve}) = 57,500\sqrt{f_c'} \quad 12-9$$

$$f_c = f_c'' [2(\varepsilon/\varepsilon_o) - (\varepsilon/\varepsilon_o)^2] \quad (\varepsilon < \varepsilon_o) \quad 12-10$$

$$\varepsilon_o = 1.7f_c'/E_c \quad 12-11$$

$$f_r = 7.5\sqrt{f_c'} \quad 12-12$$

In these equations, the units of  $E_c$ ,  $f_c$  (axial stress),  $f_c'$  (28-day cylinder strength), and  $f_r$  (tensile strength) are in lbs/sq.in. (psi) and strain,  $\varepsilon$ , is dimensionless.

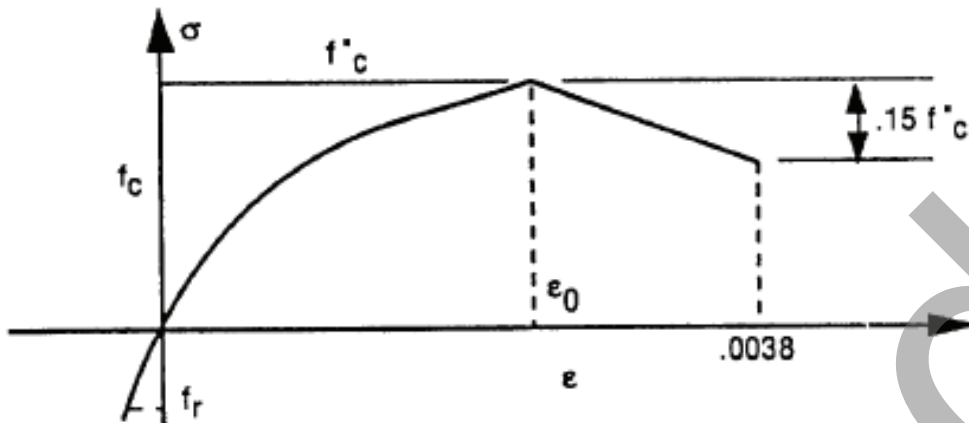


Figure 12-19 Stress-Strain Model for Concrete

In Figure 12-20:

$$\epsilon_y = f_y / E \quad 12-13$$

$$E = 29,000,000 \text{ psi} \quad 12-14$$

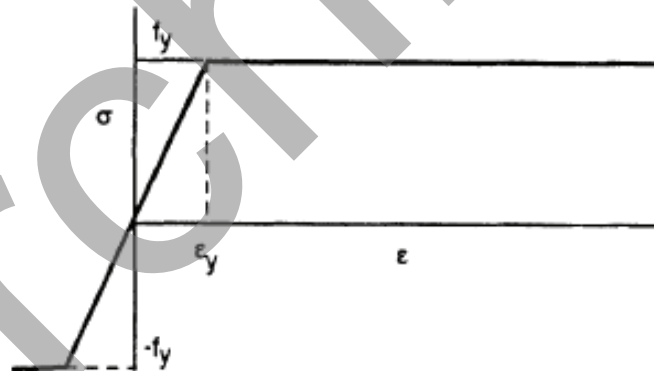


Figure 12-20 Stress-Strain Model for Steel Reinforcement

Most reinforcing steel used in drilled shafts currently is Grade 60, which has a nominal value of  $f_y$ , the yield stress, equal to 60 ksi.

Software used to compute moments, shears and deformations in the drilled shaft using the p-y method contain subroutines that automatically perform these computations and adjust the EI value along the drilled shaft during the computation according to relationships similar to the ones shown in Figure 12-18. The user need only input the strength properties of the concrete and steel and the geometric properties of the cross section and longitudinal rebar. The deflected shape, shears and moments that are computed for

the drilled shaft with a prescribed system of loads then reflect the effects of nonlinear bending, including cracking.

### 12.3.3.3 Design of an Individual Drilled Shaft for Lateral Loading

Using the principles outlined in the previous sections, the design of a drilled shaft for lateral loading is performed to satisfy the limit state conditions of stability (geotechnical limit state), flexural strength (structural limit state) and deformations (service limit state). Note that the design of the shaft diameter, depth of penetration, and structural reinforcing associated with each of these limit states must also consider axial loading and possibly other conditions as well.

#### 12.3.3.3.1 Geotechnical Strength Limit State

The shaft must be of sufficient size and penetrate to sufficient depth to support the factored design loads for each possible load case without collapse. In computations of the geotechnical limit state, deflections are not a controlling consideration.

For analyses of geotechnical strength using the p-y method, the analysis of a trial shaft diameter and penetration depth is performed in the following manner:

1. The shaft is modeled as a simple linear elastic beam, with the elastic modulus equal to that of concrete (about 4,000,000 psi) and the moment of inertia equal to that of the uncracked circular cross section ( $I = \pi D^4/64$ ).
2. The soil is modeled using the best estimate of the governing soil conditions for the structure, as appropriate for each load case. Where a number of separate foundation units are designed using a similar model, the governing soil conditions used in the model should reflect the least favorable conditions at any individual foundation location within the zone for which the model is used. Separate models should be developed where significant variations in ground conditions or loadings are anticipated (Block 10.1 of the design process flow chart on Figure 12-13). Local scour is considered, as required for a specific load case.
3. The load at the shaft head is applied in various multiples up to and exceeding the factored design load to compute deflections and thus perform a type of “pushover analysis” (Block 10.3). An unstable condition will have the result that the computer software is unable to converge to a solution, or else the solution converges to an extremely large head deflection.
4. Although deflection is not the controlling consideration for stability, the computed deflection must be a reasonable value (10% of the shaft diameter) at and slightly larger than the factored design loads in order to ensure that the shaft is of sufficient size and depth that geotechnical strength requirements are satisfied.
5. Strength at loads higher than the factored design load is necessary to ensure that a ductile lateral load response exists and that there is adequate reserve strength to accommodate site variability and other contingencies. This reserve strength is achieved by including a resistance factor less than one on the geotechnical strength for lateral resistance. AASHTO Table 10.5.5.2.4-1 currently (2007) provides for a resistance factor of 1.0 for nominal horizontal geotechnical resistance of a single shaft or shaft group and for extreme limit states. However, the values in Table 12-1 are recommended for design for geotechnical strength considerations.

**TABLE 12-1 RECOMMENDED RESISTANCE FACTORS FOR GEOTECHNICAL STRENGTH LIMIT STATE FOR LATERAL LOADING OF DRILLED SHAFTS**

Condition	Resistance Factor, $\phi$
Overturning resistance of an individual or single row of elastic shafts, free to rotate at the head using p-y method using Broms simplified method	0.67 0.40
Pushover of an elastic shaft within a multiple row group, with moment connection to the cap, using p-y method	0.8
Extreme event strength cases using p-y method	0.8

The values recommended in Table 12-1 should be considered suggested values based on the authors' judgment, in recognition that this recommended approach provides a check for ductility and geotechnical stability that exceeds the level of reliability provided by the current AASHTO (2007) code provisions.

For this evaluation of geotechnical strength, it is recommended that the pushover analysis model of the shaft should converge to a solution at loads that are at least  $1/\phi$  times the factored design load for each strength limit state load case. Satisfactory convergence would be indicated by computed deflections that are no larger than 10% of the drilled shaft diameter. In many cases the computed flexural strength of the column or connection of the shaft to the structure will be insufficient to transfer  $1/\phi$  times the factored design load. Likewise, the computed flexural strength of the shaft may be insufficient at loads which are  $1/\phi$  times the factored design load. However, the geotechnical strength analyses described above are performed with the shaft modeled as a linearly elastic beam in order to ensure that adequate embedment is achieved to provide strength and ductility from the lateral soil resistance acting on the shaft.

After the basic model parameters (soil profile, loads, etc.) are input, repeated trial analyses of various shaft diameters and embedded lengths can be performed quickly and easily using available software to determine a minimum shaft diameter and embedded length. If the shaft diameter is controlled by other factors (e.g., column size or anchor bolt pattern), the minimum embedded length for lateral loading can be determined. Note that design for axial or other considerations may ultimately dictate greater shaft diameter or embedded length.

#### 12.3.3.3.2 Structural Strength Limit State

The drilled shaft must be of sufficient size and adequately reinforced with both longitudinal and transverse reinforcement to resist the combination of bending, shear, and axial stresses which are imposed by the design loads. Therefore, the nominal axial, shear, and flexural resistance of the shaft cross section must exceed the factored axial, shear, and bending moments. At this point in the design process (Block 10 in Figure 11-1) where the minimum diameter and depth for lateral loads is established, only a preliminary check of the structural strength limit state is performed. The structural design of the shaft is finalized in Block 12 of Figure 11-1 along with the structural design of the drilled shaft connection to the

structure. The forces computed as a result of analyses for lateral loading are likely to control the structural design of the shaft.

The analyses performed for geotechnical strength using a simple linear elastic shaft will provide computed values of bending moment in the shaft at the factored design loads. The maximum bending moment in the shaft is a function of the applied loads and the soil resistance distribution along the length of the shaft; the nonlinear bending stiffness ( $EI$ ) described in Section 12.3.3.2.2 has relatively little effect on the maximum computed bending moments. A quick check of potential bending moment capacity for a given shaft diameter can be made using the preliminary estimates of bending moment capacity outlined in Section 12.3.2.2. If the computed maximum bending moments greatly exceed the preliminary estimate of capacity for a shaft with reinforcing equal to approximately 1.5% of the cross sectional area, the designer should consider larger shaft diameter.

Although the complete structural design must consider combined axial, shear, and bending, the first check of required longitudinal reinforcement for flexure can be determined at this point using the concepts described in Section 12.3.3.2.2. The complete structural design procedure includes the following general considerations:

- The axial, shear, and bending moments are determined using factored loads.
- The longitudinal reinforcing is determined which provides a nominal structural strength exceeding the combined factored axial forces and bending moments in the shaft for each load combination.
- The nominal shear capacity of the concrete section is compared with the factored shear forces, and additional transverse reinforcement (above the code-specified minimum) is determined, if necessary.

The complete structural design of the drilled shaft is described in Chapter 16.

#### **12.3.3.3.3 Servicability Limit State (Lateral Deformations)**

Deformation limits should be chosen based upon actual serviceability requirements for the structure rather than “rule of thumb” criteria. Deformation and rotation computed at the top of shaft for a single column, single shaft foundation can be amplified at the pier cap for a tower bent. Structures such as overhead signs or sound walls are not particularly sensitive to deformations, but some serviceability limits may be established for aesthetics, functionality, or other considerations. Some extreme event load cases (for example, the check flood for scour or some seismic loadings) may not include serviceability requirements.

In many cases, a significant component of the deformation can be related to flexural stiffness of the drilled shaft and not the ground response. The nonlinear model of the reinforced concrete shaft in flexure described in Section 12.3.3.2.2 should be used to model this condition. Unfactored service loads are used in the analysis. With the computer model that has been established for the analysis of strength, this step generally only requires the adjustment of the load for the service limit state conditions and the additional input to specify the nonlinear structural material properties of the shaft (longitudinal reinforcement and concrete strength and modulus).

#### 12.3.3.3.4 Example

Consider the example used in the preliminary analysis, which was a drilled shaft with a factored shear force at the ground line of 40 kips and a factored overturning moment of 800 kip-ft. Borings have been made which suggest that the soils consist of a very stiff clay soil having an undrained shear strength of 15 psi. Our preliminary analyses suggested that a 4-ft diameter shaft would likely be suitable. Maximum service loads have been determined to be 25 kips shear plus 500 kip-ft applied moment, and the maximum lateral deformation at the top of shaft is not to exceed ½ inch.

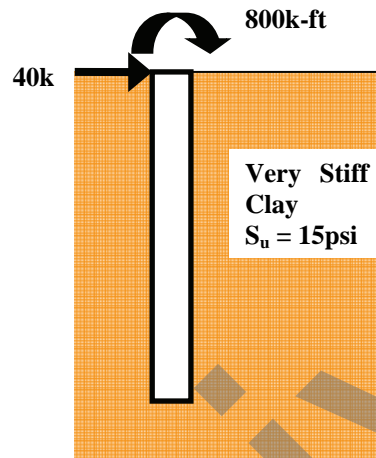


Figure 12-21 Simple Lateral Load Example, Factored Loads Shown

#### Geotechnical Strength Limit State.

For this simple problem, the computer software LPILE is used to perform analyses with the p-y method on a 4-ft diameter shaft with a range of loads (all with applied moment and shear in proportions similar to the factored design loads of 40 kips shear + 800 kip-ft moment) and for several different embedded lengths of shaft. For analysis of this problem using the computer software, the important input parameters are:

- Boundary conditions at top of shaft (applied shear and moment; axial force = 0)
- Trial shaft diameter (48 inches) and bending stiffness, EI ( $E = 4,000,000\text{psi}$ ,  $I = \pi d^4/64 = 260,576\text{ in}^4$ )
- Trial shaft length, divided into 100 nodes for analysis
- Soil strength and stiffness (described in Section 12.3.3.4.1, for this simple one-layer problem: unit wt = 0.07 pci, cohesion = 15 psi,  $\epsilon_{50}$  = default value of 0.005 for this soil)

The description of the problem provided above accomplishes Blocks 10.1 and 10.2 of the flow chart in Figure 12-13. For the analysis of geotechnical strength (Block 10.3), the guidelines provided previously in Table 12-1 suggest the use of a resistance factor,  $\phi$ , of 0.67. In order to mobilize a resistance that, when multiplied by 0.67, meets or exceeds the factored load combination, it is necessary to perform the analysis using  $1/\phi$  times the factored loads. Therefore, the computer analysis of the trial shaft with linear elastic properties in flexure should converge to a solution with a deflection not exceeding 10% of the

shaft diameter (= 4.8 inches) at applied lateral and overturning forces which are 1.5 times (1/0.67) the factored loads, or 60 kips shear + 1200 kip-ft overturning moment.

The results of these analyses in terms of top of shaft deformation versus shear (and applied moment) are illustrated on Figure 12-22a for a range of shear + overturning at the top of shaft of up to 60 kips + 1200 kip-ft applied overturning moment. The graph is presented with shear on the vertical axis, but each data point is generated using applied overturning moment in proportion to the shear.

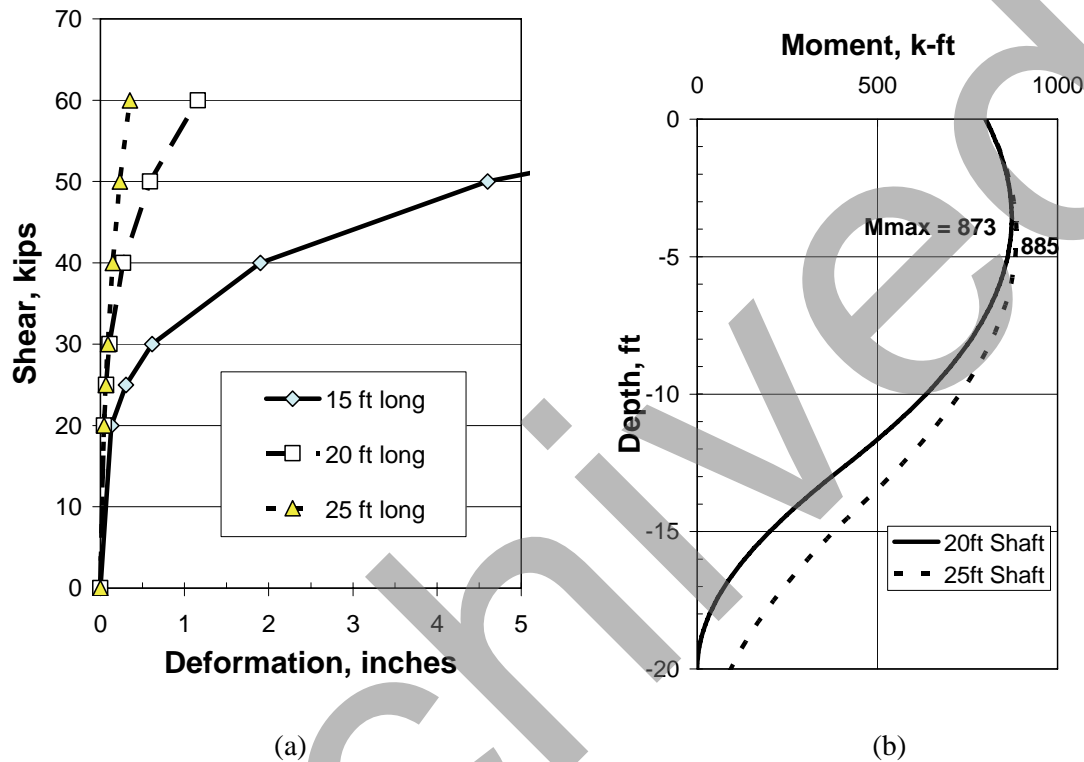


Figure 12-22 Results of Analyses of Geotechnical Strength for Simple Example: (a) Shear Load versus Deformation; (b) Bending Moment versus Depth

The analyses indicate that marginal stability is achieved with a 15 ft deep shaft as evidenced by the large deformation at a load which is 1.5 times (1/φ) the factored design load. Although a convergent solution was obtained, the computed deformation of this shaft at this load exceeds the general guideline recommendation for the geotechnical strength limit condition of 10% of the shaft diameter (4.8 inches). By contrast, an additional 5 ft of embedment provides a much more robust design with stability at loads in excess of the factored design load.

The bending moments are not much affected by embedded length as is evident from the results of the aforementioned analysis for the 20 and 25-ft long shafts plotted on Figure 12-22b. The maximum computed bending moment for the factored load case (40 kips shear + 800 kip-ft moment) is about the same for each, around 880 kip-ft. Note that this maximum moment is somewhat less than the 1072 k-ft computed using the preliminary approximate solution.

For the next step in the design process, the 20-ft long by 4-ft diameter shaft is considered for further analyses.



Evaluation of structural limit state (Block 10.4) and serviceability limit state (Block 10.5) can be performed by revising the analysis to include nonlinear flexural stiffness. Analysis is performed by specifying the shaft to be a nonlinear reinforced concrete circular member, 48 inches diameter, and reinforced with 12 #11 bars (equal to approximately 1% of the cross sectional area of the concrete) equally spaced in a circular arrangement with 3 inches cover. Concrete compressive strength of 4,500 psi and reinforcement yield strength of 60,000 psi is specified.

Results of analyses for structural and serviceability limit states are illustrated on Figure 12-23.

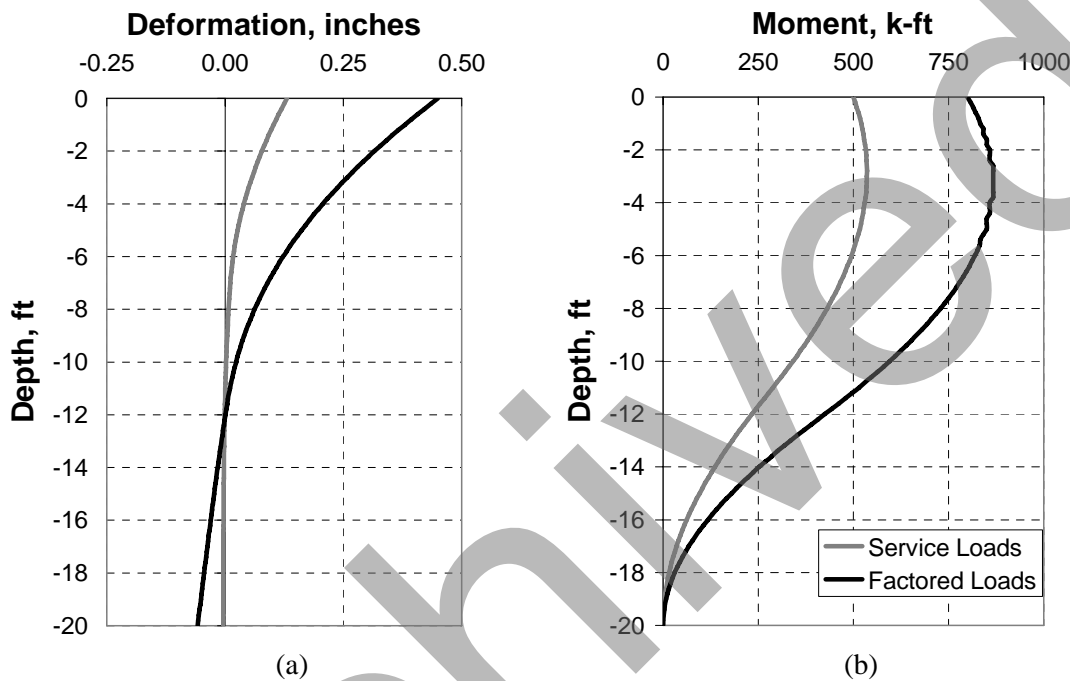


Figure 12-23 Results of Analyses of Structural Strength and Serviceability for Simple Example: (a) Deformation; (b) Bending Moment versus Depth

The computed maximum bending moment for the analysis of structural strength using factored loads and nonlinear EI for the shaft was 865 k-ft (Figure 12-23b), compared to 873 k-ft for the linear elastic model at the same magnitude of load (shown on Figure 12-22b). As noted previously, the computed maximum bending moment is not very sensitive to the flexural stiffness of the shaft.

The maximum computed deflection was 0.13 inches at the top of shaft for the service load condition of 25 kips shear, 500 k-ft applied moment (Figure 12-23a). This value is well within the stated requirement for this example of 0.5 inches deflection at service loads. Note that the computed deflection at this magnitude of lateral and overturning force for the earlier analysis with constant (linear elastic) EI was 0.07 inches. The larger deflection for the nonlinear case is due to reduced flexural stiffness in the shaft caused primarily by cracking of the drilled shaft concrete.

The computed relationships of bending moment vs. curvature and bending moment vs. flexural stiffness (EI) for this tentative design is computed using the procedures outlined in section 12.3.3.2.2 and the results of these analyses are illustrated on Figure 12-24 and Figure 12-25, respectively. The computed nominal moment resistance is significantly larger than the computed moment from the factored design load.

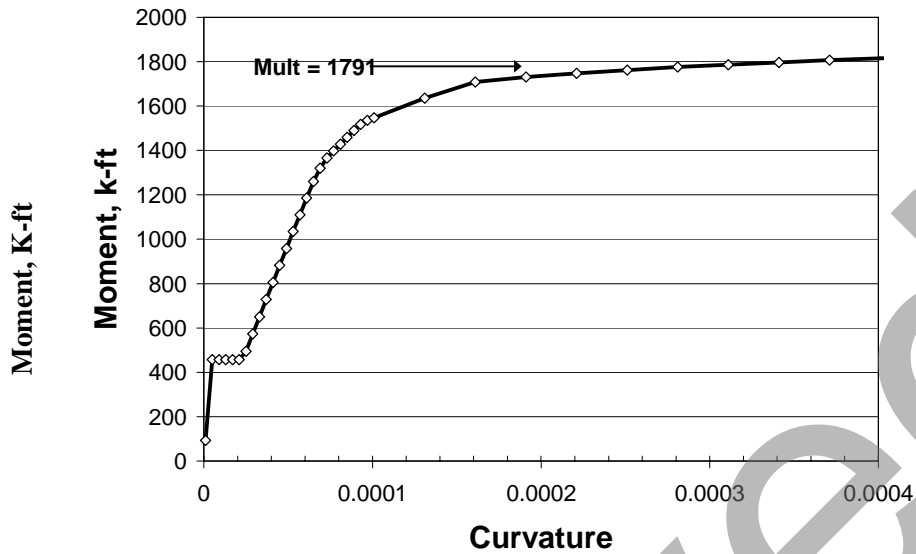


Figure 12-24 Bending Moment versus Curvature for Simple Example

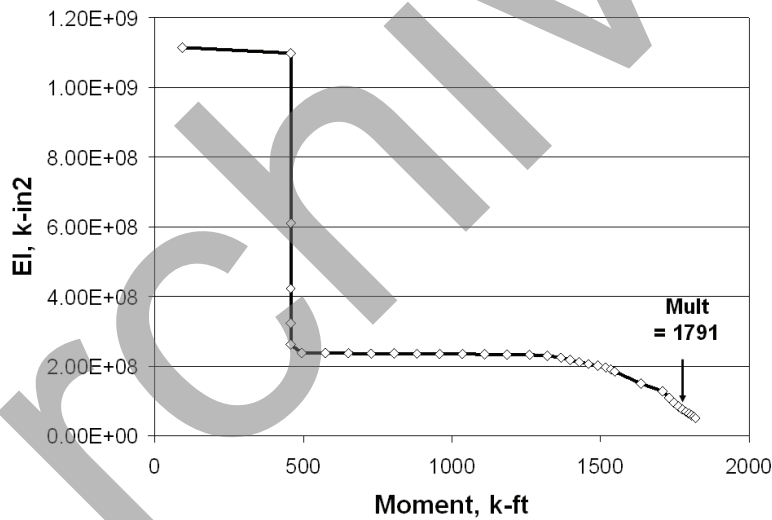


Figure 12-25 EI versus Bending Moment for Simple Example

In summary, this simple example illustrates the process of design to include each of the three important limit state conditions: 1) geotechnical strength limit state (diameter and embedded length), 2) structural strength limit state (shaft diameter and longitudinal reinforcing), and 3) deflections for serviceability limit state. The complete design will require consideration of all other loading conditions (particularly axial loads). In some cases groups of drilled shafts may be considered, as described in Chapter 14.

### 12.3.3.4 Guidelines for Selection of Appropriate p-y Criteria for Design

This section provides an overview of available p-y criteria used in design of drilled shafts for lateral loads. The purpose of this discussion is to provide some guidance in the appropriate selection and use of these criteria for typical problems in design of transportation structures. A more complete description of the experimental basis and applicability for each criterion is available through the provided references in each section and through technical manuals associated with specific software codes.

The p-y criteria are simply a means of associating the soil resistance mobilized as a nonlinear function of displacement at various points along a drilled shaft. Although there may exist a theoretical basis in many cases, the criteria used in design are empirical in that the final form of the models used are derived from experiments (instrumented load tests). Therefore, it is necessary that the user must understand the experimental basis for a p-y criterion that is being used so that limitations are understood and so the models can be used for appropriate conditions.

#### 12.3.3.4.1 Cohesive Soils

Several criteria are available for modeling cohesive soils, and the most commonly used include those for soft clays (Matlock, 1970), stiff clays (Welch and Reese, 1972) and stiff clays in the presence of free water (Reese et al, 1975). Each of these are characterized by the use of a polynomial to model the nonlinear relationship of soil resistance versus displacement followed by an upper bound as shown in Figure 12-26.

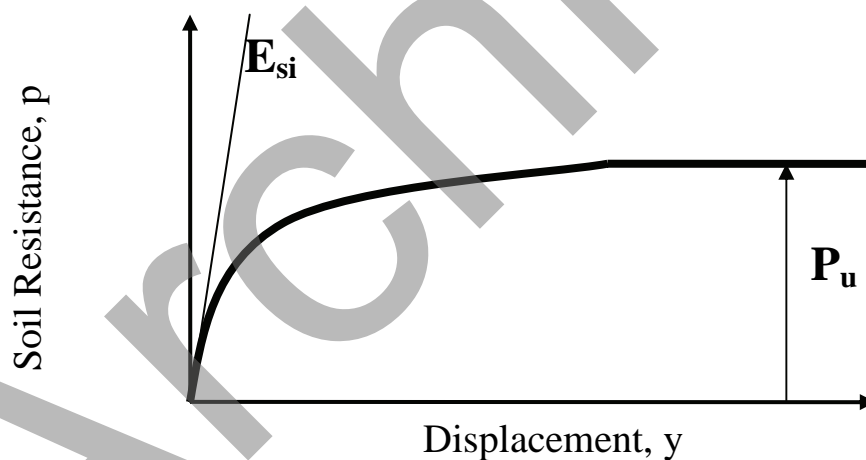


Figure 12-26 Conceptual p-y Curve for Cohesive Soil

The input cohesive soil parameter that most significantly affects the response of a drilled shaft in soils using p-y curves for these criteria is the soil cohesion (undrained shear strength,  $S_u$ ), which directly affects the ultimate soil resistance,  $P_u$ . The undrained shear strength used to develop the p-y criteria is typically measured using unconsolidated, undrained (UU) triaxial compression tests with confining pressures at or near the total overburden pressure.

A parameter which has a somewhat less significant effect in cohesive soils is the initial stiffness,  $E_{si}$ .  $E_{si}$  is most commonly related to a stiffness parameter,  $\epsilon_{50}$ , which is intended to represent the strain at an axial

compressive stress equal to 50% of the yield stress in the UU triaxial test. Typical values of  $\epsilon_{50}$  are often simply associated with a given range of  $s_u$ .

The use of undrained shear strength,  $s_u$ , has proven to provide a reliable correlation with load test results of short duration. The instrumented field loading tests performed to develop these criteria have typically been performed within a period of a few hours, so this model of soil resistance is appropriate for short duration loadings typical of live loads on highway structures. Long duration sustained loads may actually mobilize a softer response due to creep, and extremely short duration transient loads may actually mobilize a stiffer response due to rate of loading effects.

Engineers using these p-y criteria to design a drilled shaft for lateral loading should perform analyses using a range of values of  $s_u$  and  $\epsilon_{50}$  in order to evaluate the sensitivity of the analysis to these parameters. There always exists uncertainty in the evaluation of in-situ soil properties as well as in the relationship of these properties to the ultimate performance of the foundation. Sensitivity studies can provide the information needed to develop judgment regarding the reliability of the design and the relative importance of various input parameters.

With respect to stiff clays, engineers are sometimes faced with the decision regarding the applicability of the criterion from Reese et al (1975) for stiff clay in the presence of free water. The tests performed to develop this criterion were performed using cyclic loading at a site of stiff fissured clay ( $s_u \approx 2$  ksf) in a submerged condition. The soil response was observed to rapidly degrade with multiple cycles of load due to localized scour adjacent to the pile, and the criterion developed for static loading also exhibits significant strain-softening resulting in a characteristic response as indicated in Figure 12-27.

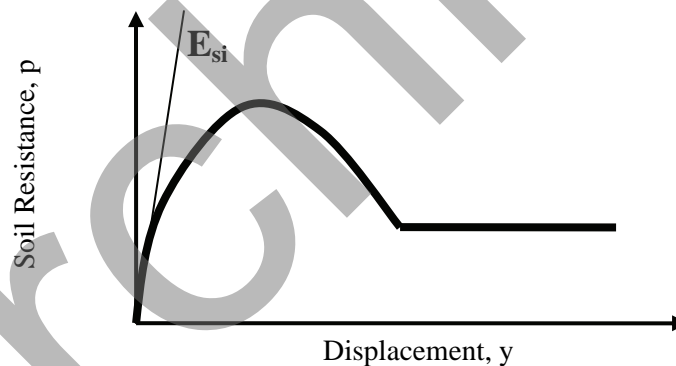


Figure 12-27 Conceptual p-y Curve for Stiff Clay in the Presence of Free Water

The criterion shown in Figure 12-27 will result in a substantial reduction in mobilized soil resistance compared to that of Welch and Reese (1972), which does not include such strain softening. This reduction is only appropriate for situations where stiff clay is exposed to free water at or near the ground surface, where degradation similar to that observed in the load test experiment can occur. In conditions where the groundwater surface is at depth and free water is not present at or near the ground surface, the Welch and Reese criterion is more appropriate, even below groundwater. Similarly, stiff clay strata at depth below a sand stratum would normally not be subject to degradation due to free water (unless scour removed the overlying sand).

#### 12.3.3.4.2 Cohesionless Soils (Sands)

Several criteria are available for modeling cohesionless soils, and the most commonly used include Cox, et al (1974) and the very similar criterion of Murchison and O'Neill (1984) that has been adopted as a standard by the American Petroleum Institute. Each of these are characterized by the use of an initial linear stiffness followed by a polynomial to model the transition to an upper bound as shown in Figure 12-28.

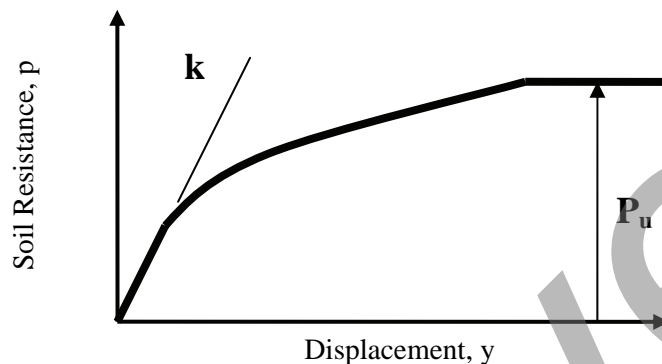


Figure 12-28 Conceptual p-y Curve for Cohesionless Soil

The input soil parameter that most significantly affects the response of a drilled shaft in sand using p-y curves for these criteria is the modulus value,  $k$ , which directly affects the initial straight line portion of the curve. The values used for this parameter  $k$  are estimated within the range of 20 to 225 lb/in.<sup>3</sup> based on an assessment of the relative density of the sand and the effect of a submerged or dry condition. The ultimate resistance,  $P_u$  is related to the angle of internal friction ( $\phi$ ) and the confining pressure, but the lateral response of drilled shafts in sand is less sensitive to  $\phi$  than to  $k$ .

#### 12.3.3.4.3 Cohesive Granular (c- $\phi$ ) Soils

The c- $\phi$  criterion currently available in LPILE is based on the superposition of p-y criterion for cohesive soils and cohesionless soils; this criterion is not supported by experimental data and not recommended for foundation design. In the absence of site-specific load test data with which to calibrate an alternative p-y criterion, the designer should use an approach based on either a cohesionless soil or a cohesive soil with a best estimate of undrained shear strength as a function of depth.

Some recent research, including full scale load tests in cemented granular soil (loess), has been conducted in Kansas, and used to develop a p-y curve criterion for loess as reported by Johnson, et al (2007).

#### 12.3.3.4.4 Rock

The methods currently available for predicting the p-y response of rock are based on a limited number of experiments and on correlations that have been presented in the technical literature (Reese, 1997). In general, the recommendations provided for weak rock are recommended as conservative estimates for most design purposes.

The p-y response is represented by a curve (shown on Figure 12-29) similar to that used for cohesive soils described previously, except that the ultimate resistance is correlated to compressive strength,  $q_u$ , rather than undrained shear strength. In lieu of the stiffness parameter,  $\epsilon_{50}$  used for cohesive soils, a similar parameter,  $k_{rm}$  is used for weak rock. The initial stiffness,  $K_{ir}$  of the curve is proportional to the compressive strength of the rock, the initial modulus of the rock mass,  $E_{ir}$ , and the value of  $k_{rm}$ , with suggested values of  $k_{rm}$  in the range of 0.00005 to 0.0005. The lower value provides a somewhat stiffer initial response.

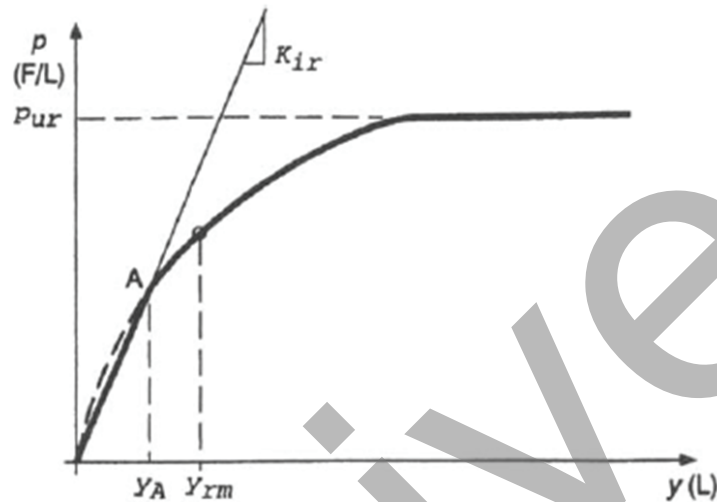


Figure 12-29 Proposed p-y Criterion for Weak Rock (Reese, 1997)

In many cases, weak or decomposed rock is difficult to characterize in terms of strength and stiffness. A recent series of tests were performed of drilled shafts of various sizes and lengths socketed into a severely weathered and decomposed quartzite (Brown and Kahle, 2002). The decomposed rock had SPT N-values that were at 50 blows with less than 2 inches penetration, coring recovery values of less than 20% and RQD values of 0. The test shafts, 3 to 5-ft diameter and embedded 1 to 2 diameters, were loaded to geotechnical failure in overturning. The results of the load tests were modeled very effectively using the weak rock criterion with values of  $q_u = 180$  psi,  $E_{ir} = 27,000$  psi ( $150 q_u$ ), and  $k_{rm} = 0.0004$ . These results might represent a reasonable lower bound estimate for cases in which hard but decomposed rock is known to be present, but the geotechnical investigation is unable to provide much meaningful strength information about the decomposed rock formation.

Strong rock has been characterized using a model developed from tests in vuggy limestone of southern Florida, and the p-y response is modeled using a bilinear model as shown on Figure 12-30 (Ensoft, Inc., 2004). On that figure  $s_u$  is defined as  $\frac{1}{2}$  the unconfined compressive strength,  $q_u$ , and  $b$  is the diameter of the drilled shaft.

One distinctive characteristic of this p-y formulation is the fact that the field load tests upon which the criterion was based were carried to only limited displacement. The authors therefore thought it prudent to assume that a brittle fracture might occur at higher displacements, since the vuggy limestone was known to be quite brittle in shear. This upper limit at which brittle failure occurs works out to a shaft displacement at the location of the rock p-y curve equal to 0.24% of the shaft diameter; e.g. about 0.1 inches for a 3.5-ft diameter shaft and 0.2 inches for a 7-ft diameter shaft. At displacements larger than this upper bound value, the resistance of the rock is assumed to drop to zero. As a result of this assumed

brittle behavior, an engineer using this criterion can find the curious result in which the computed lateral response of a drilled shaft is weaker using the “strong rock” criterion than would be the case using the “weak rock” criterion with similar strength values.

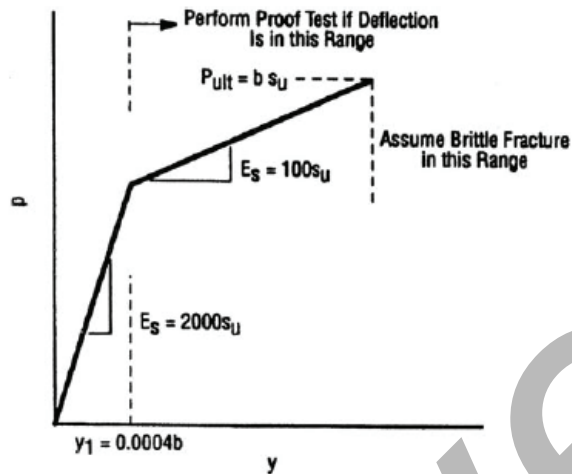


Figure 12-30 Proposed p-y Criterion for Strong Rock (Ensoft, Inc., 2004)

While there may be some extremely brittle rock formations in which strength and lateral resistance dramatically drops to near zero at a displacement in the 0.1 to 0.2 inch range, it is unlikely that this type of response is representative of most rock formations encountered in practice. It is recommended that an engineer using this strong rock criterion should perform a check on displacements computed using the p-y model and instead utilize the weak rock criterion for cases where shear failure of the rock mass is considered possible.

#### 12.3.3.4.5 Correlations with *In-Situ* Tests

There exist a number of published correlations for computing p-y curves based upon the results of *in-situ* tests such as the pressuremeter (Briaud, 1992) or dilatometer (Robertson et al, 1985). In general, these test data rely on empirical correlations with test measurements to develop p-y curves for design, with consideration of soil type, depth, and shaft diameter. Comparative evaluations suggest that these tools can provide useful correlations (Anderson et al, 2003); as with any empirical relationship, calibration to field load tests in geologic conditions which are representative of the local area provide the most reliable application of these correlations for design.

#### 12.3.3.4.6 Variations in Stratigraphy

In many cases, variations in stratigraphy across a site represent a more significant variable than the strength characteristics of any one particular stratum. This is particularly true when there exists a relatively soft soil layer overlying a strong layer such as rock.

As an example, consider the case shown in Figure 12-31 of a 6-ft diameter by 40-ft long drilled shaft installed through a 20-ft thick layer of soft clay ( $s_u = 2$  psi) into a weak rock ( $q_u = 180$  psi,  $E_{rm} = 27,000$  psi) and loaded with a shear force of 75 kips at the ground surface. For this simple example, the effects of variations in soil properties are as follows:

Case	Deflection, in	Maximum Moment
Base Case (described above)	0.116 inches	15,722 inch-kips
Soft clay thickness increased 10%	0.142, incr 22%	16,590, increase 5.5%
Soft clay strength reduced 10%	0.118, incr 2%	15,880, increase 1%
Rock $q_u$ and $E_{rm}$ reduced 10%	0.118, incr 2%	15,720, no change 0%
Strong Rock bearing, $q_u = 750$ psi	0.125, incr 8%	15,410, decr 2%

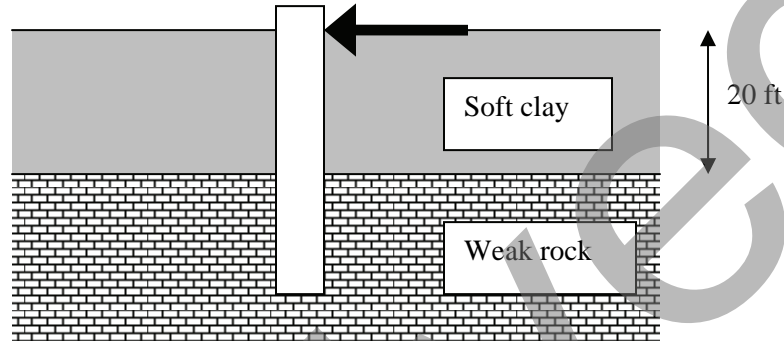


Figure 12-31 Example for Sensitivity Analysis of Stratigraphy

The results of this hypothetical problem indicate the relative importance of defining the stratigraphy and the possible range of variations with respect to lateral load response. It also demonstrates the value of performing a sensitivity analysis in order to determine the most important parameters. Note also that the use of the strong rock (vuggy limestone) criterion resulted in a larger computed displacement even with a  $q_u$  of 750 psi instead of the 180 psi used for the weak rock criterion. This counterintuitive result suggests that the use of the strong rock criterion might have limitations for use in rock formations beyond the vuggy limestone from which it was derived.

#### 12.3.3.4.7 Effects of Cyclic Loading

Repeated cyclic lateral loading can affect the lateral soil resistance (most significant in cohesive soils), and a model of the degradation of soil resistance is included in the p-y criteria described previously. The most significant degradation effect occurs in submerged conditions when large lateral displacements at the soil surface result in gapping around the shaft. With repeated cycles of loading, water is alternatively sucked into the gap around the shaft and then expelled as the gap closes, eroding the soil and enlarging the gap. This effect can be a significant consideration for coastal structures subject to repeated wave loading.

#### 12.3.3.4.8 Effects of Rate of Loading

Transient loads of short duration such as seismic, wind, and vessel impact loadings apply lateral loads to the soil at a higher rate of loading than is commonly measured during a static load test which may be conducted over a period of hours. The p-y criteria described previously have been developed based on static load tests and thus do not directly address the effect of a high rate of loading associated with transient load events. The higher strain rate associated with rapid lateral loading in soil would generally be expected to produce a somewhat stiffer response and greater strength. The use of static analyses may



be somewhat conservative for such conditions, but the direct consideration of rate of load effects is generally not justified for routine foundation design.

Long term sustained lateral loads, such as from lateral earth pressure loads, may have the opposite effect. Particularly with respect to clay soils, long term creep can reduce the soil stiffness relative to a short term static p-y curve based on undrained shear strength.

#### 12.3.3.4.9 Strain Wedge Model

The strain wedge method (Ashour et al, 1998) was derived from an attempt to provide a more theoretical basis for correlating lateral soil resistance than is associated with the largely empirical p-y model commonly used for analysis. The soil resistance is correlated with the mobilization of forces from a 3-D passive soil wedge as per a limit equilibrium solution of passive earth pressure resistance. The lateral displacement to mobilize the soil resistance is associated with estimated strains in the soil within the passive wedge.

In most respects, the software available for analysis of a drilled shaft using the strain wedge model is similar to the p-y approach described previously, with the shaft modeled as a nonlinear beam and the solution derived from a finite difference solution of the beam-on-elastic-foundation problem. The design process would follow identically with the process described previously for the p-y approach. The differences in the strain wedge model derive from the way in which the soil resistance is computed. This section provides a brief overview of the assumptions and basis for the strain wedge model of soil resistance.

The soil resistance is derived from the forces acting on a passive wedge as illustrated on Figure 12-32; details of the derivation and nomenclature are provided in the reference shown in the caption. The soil resistance is mobilized as a function of displacement of the soil, and the relationship between passive soil resistance and deformation is associated with the accumulated strains within the passive soil wedge. The strains are assumed to vary linearly over the depth of the wedge according to Figure 12-33.

Based on the soil stress-strain and strength properties, as determined from laboratory tests, the horizontal soil strain ( $\epsilon$ ) in the developing passive wedge in front of the pile is related to the deflection pattern ( $y$ ) versus depth. The horizontal stress change ( $\Delta\sigma_h$ ) in the developing passive wedge is related to the nonlinear modulus of subgrade reaction, which is the slope of the p-y curve. The strain wedge model can be used to develop p-y curves for soil, and reportedly has shown good agreement with load test results (Ashour and Norris, 2000).

One of the reported benefits of the strain wedge approach is that the method can directly accommodate the effect of stratigraphic variations on soil properties and behavior at a given elevation, and thus address the theoretical limitation of the p-y approach which uses independent nonlinear springs to model the soil resistance. Multiple soil layers with differing properties require that the shape of the wedge and strain patterns within each separate layer be modified to accommodate the theoretical passive wedge with the material property changes. Figure 12-34 is an illustration of the concept used for multiple layers of soil. Since the individual passive wedges have different geometry, a transition between wedges is assumed, with the behavior of each individual layer associated with the stress conditions computed at the center of the wedge.



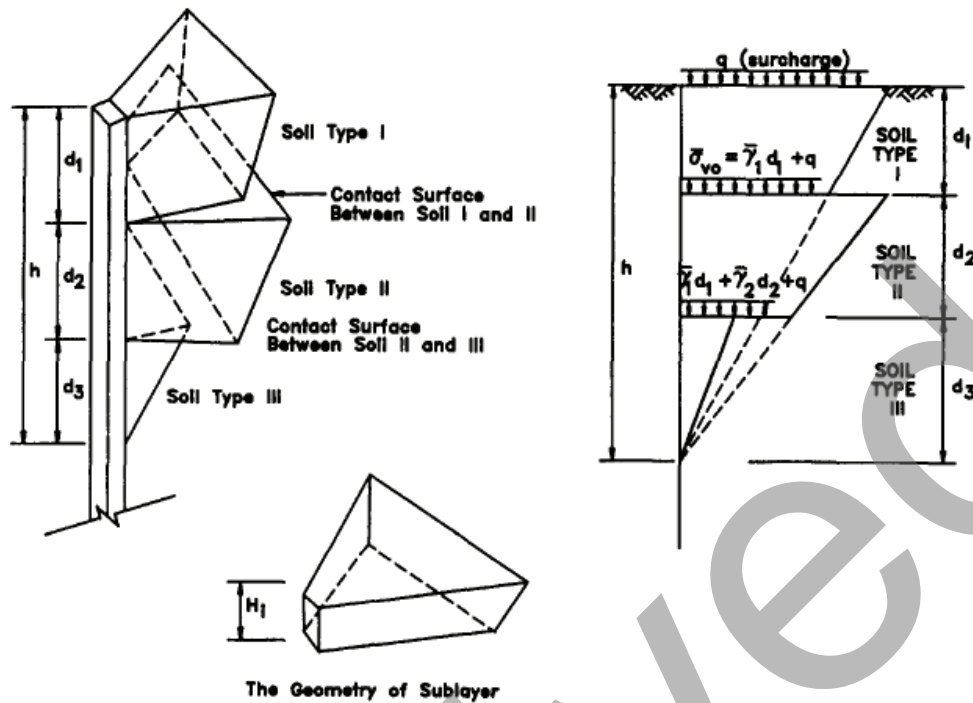


Figure 12-34 Proposed Geometry of Compound Passive Wedge (Ashour et al, 1998)

Another reported benefit of the strain wedge approach is that group effects are addressed directly using the geometry of overlapping passive wedges from nearby piles. The 3-D soil-pile interaction behavior is modeled by considering the lateral resistance that develops in front of a mobilized passive wedge of soil at each depth.

As with any model of complex three dimensional nonlinear soil-structure interaction problems in geotechnical engineering, the strain wedge model has inherent limitations due to necessary simplifications of the problem and due to the inherent limitations in predicting in-situ stresses and nonlinear stress-strain behavior of layered geomaterials. Comparisons to full scale field tests performed under realistic conditions should accompany the implementation of strain wedge or any new model so as to provide field verification testing under a broad range of conditions.

### 12.3.3.5 Considerations for Scour and Extreme Event Loading

Extreme event load combinations may include forces from earthquakes, ice, vessel impact, and increased scour effects from the check flood on structure stability. Scour for the 100 year flood event is not considered an extreme event, but requires some special considerations. In addition, some extreme events are combined with different levels of scour (for example, vessel impact loads). In general, the recurrence interval of extreme events is thought to exceed the design life of the structure. Overall design considerations for extreme event loadings are discussed in Chapter 15.

Ice and vessel impact forces are included in design using computational procedures described previously for static loading. In general, there are no special considerations for these load cases with respect to the computation of lateral load response other than the consideration of various combinations with different scour levels.

Some specific issues related to the effects of scour and earthquakes on lateral loading are discussed below.

#### **12.3.3.5.1 Considerations for Scour**

Scour is an important consideration for bridges over waterways, and the effects will lower the surface elevation of the subsurface profiles defined in Block 10.1 for design. Scour includes the general scour (scour that may occur without the presence of the structure) and channel contraction scour (due to the presence of the structure in the waterway) plus local scour immediately around the bridge piers. A further discussion of scour associated with the design flood event and the effects on the overall design of drilled shaft foundations is provided in Chapter 13.

The consequences of changes in foundation conditions from the design flood event are included in design for lateral loads at strength and service limit states. The scour associated with the check flood is considered an extreme condition which may lower the surface elevation more significantly for strength load combinations. AASHTO Section 10.5.5.3.2 also requires that the nominal resistance remaining after the check flood condition must be adequate to support the unfactored strength limit states loads with a resistance factor of 1.00.

#### **12.3.3.5.2 Considerations for Earthquakes**

Earthquake-induced lateral loads imposed from the structure onto the foundation are typically analyzed using the computational procedures described previously for static loading, but may include some additional considerations. A discussion of the overall design of foundations for earthquakes is provided in Chapter 15.

Design forces for foundations are taken as the lesser of: (1) forces determined by elastic structural analysis of the bridge under Extreme Event Load Combination I, or (2) the force effects at the base of the columns corresponding to column plastic hinging. Determination of inelastic hinging forces is presented in Section 3.10.9.4.3 of AASHTO (2007a). For the latter case, design for lateral load may include a drilled shaft designed to provide structural strength in excess of the structural demand associated with formation of a plastic hinge at the base of the column, and with a Type II connection to the column as described in Section 12.2.1 and shown on Figure 12-2. The maximum bending moment will typically occur at some point below the top of the shaft, and the nominal structural strength in the shaft must be sufficient to resist this moment and ensure that any damage from a seismic overstress condition occurs at the base of the column above ground where it can be inspected.

The design objective of the Type II connection is to ensure that plastic hinge forms at base of column, top of shaft, where it can be inspected. The greatest challenge for design occurs when the shaft is subject to moment demands below grade that may be significantly higher than that at the top of shaft, and this condition is most likely to occur in an area of soft soil (or liquefaction) underlain by something hard. If the soft layer extends to a great depth then a shaft (or pile) group may offer the only practical solution.

An example analysis of a Type II shaft is described below and illustrated on Figure 12-35 for two hypothetical soil profiles. This example includes pushover analyses calculations to evaluate the potential for yielding below grade, for the case of a 7-ft diameter column into a shaft which is either 8.5 ft or 9 ft diameter. Both column and shaft have about 1.5% longitudinal reinforcement. Figure 12-35 provides a

plot of moment demand divided by the nominal strength (or ultimate, for the column) as a function of depth. The ultimate resistance of the column in flexure (plastic hinge moment) is calculated using a yield stress in the GR60 reinforcement of 68 ksi, as is the practice of Caltrans. The structural strength in the transition zone between the column and shaft is interpolated over a distance of one column diameter from -30 to -37 ft on the graph.

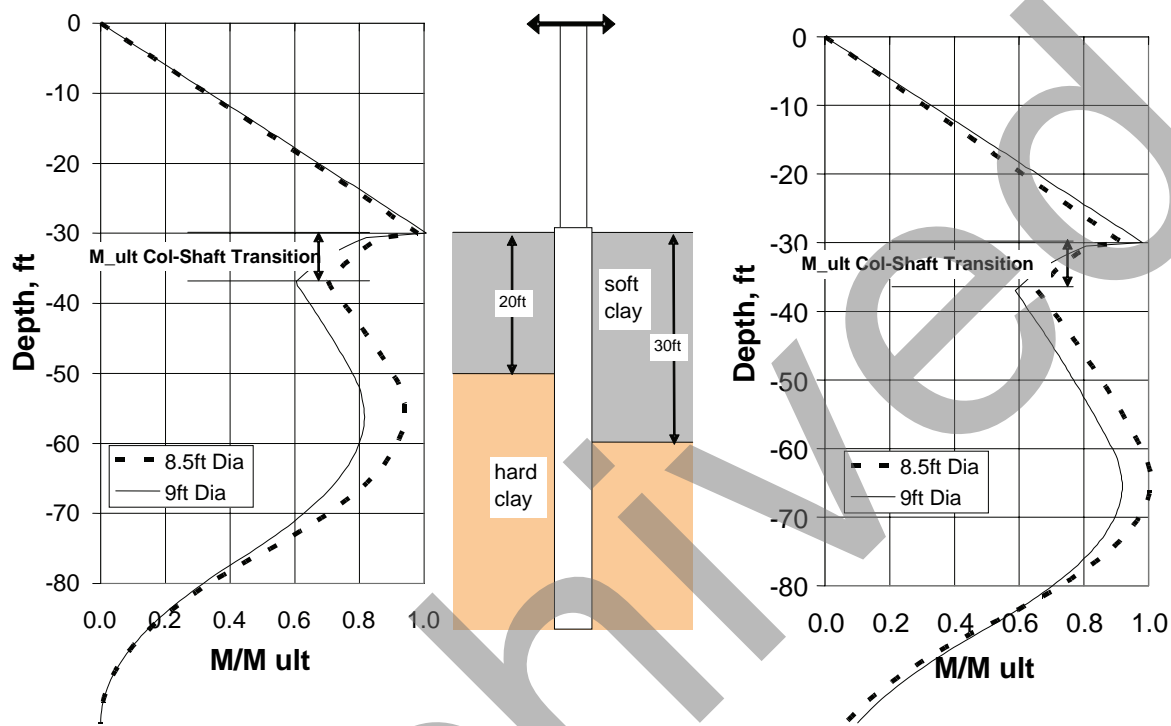


Figure 12-35 Pushover Analysis of a Column Supported on a Drilled Shaft

This simple example, performed using the computational procedures outlined in Section 12.3.3, illustrates the effects of stratigraphy on the moment demand in the drilled shaft and of shaft diameter on the nominal structural strength for this case. The computed bending moment for the case of the 30-ft deep very soft clay stratum exceeds the nominal strength of the shaft at a depth of about 64 ft from the top of the column (34 ft below grade) for the 8.5-ft diameter shaft. The similar case with a 9-ft diameter shaft results in yield at the base of the column as desired. For both soil profiles, a slightly larger (6 inch) shaft diameter is seen to provide a significant benefit in terms of strength relative to demand.

With respect to the design subsurface profile defined in Block 10.1, some strata may be defined at a reduced strength due to liquefaction. A further discussion of the effects of liquefaction and lateral spreading is provided later in this chapter in Section 12.3.6.

### 12.3.4 Alternative Models for Computation of Shaft Response

Although the p-y method is recommended for design, available alternative models can be employed in some circumstances. The following sections provide an overview of the Broms Method (Broms, 1964a, 1964b, and 1965), which offers a simple computation method that may be useful for sign or sound wall foundations constructed using short drilled shafts. In addition, the Broms Method provides a rational limit equilibrium solution which is easy to understand in terms of the basic principles of computing the strength limits of a simple problem. Therefore, an understanding of the method is useful as an instructional tool.

Several other alternative models include those based on elastic continuum, boundary element, and finite element models. A brief overview of these models is included in Appendix H, with references for further investigation.

#### 12.3.4.1 Broms Method

The Broms method is an approximate approach which is subject to significant limitations relative to the more sophisticated p-y models that are recommended and available using computer software. The Broms method is a simplified limit equilibrium solution that is suitable for simple analyses of relatively short, stiff drilled shafts subject to lateral shear and overturning moments. Examples of structures which might be analyzed using the Broms method include sign or sound wall foundations in uniform or relatively simple soil profiles.

In order to perform an analysis using this method, a simple soil passive pressure diagram is assumed and a limit equilibrium solution can be obtained through derivation of equations of static equilibrium of shear and moment in the shaft. Although the original paper proposed a method for analysis of piles with full moment connection to a cap which is “fixed” against rotation, it is recommended that the use of the method is limited to these simple applications in which shear and overturning are applied at the top of a shaft which is free to rotate.

The method is most suited to analysis of strength limit states. Analysis of deformations (serviceability) in the original papers was based on a simplified subgrade reaction model for an elastic pile that is not considered to be very reliable.

For analysis of geotechnical strength limit state of a drilled shaft using the Broms method, a resistance factor of 0.4 is recommended, as indicated earlier in Table 12-1. This recommendation is provided based on the judgment of the authors, considering the fact that:

- the method uses a bearing capacity type analysis based on a limit equilibrium solution, similar to a bearing capacity analysis of a shallow foundation,
- the method is recommended only for non-critical structures such as signs, light poles, or soundwalls, and not for bridges or retaining walls,
- the geotechnical information at specific foundation locations in the aforementioned type of applications is often sparse, based on crude sampling from borings at widely spaced locations,
- the current AASHTO code does not provide guidance for the evaluation of geotechnical strength of drilled shafts using the Broms method.

If the size and scope of a project is such as to warrant a more thorough program to develop site specific geotechnical information, the designer should consider the use of the computer solutions employing p-y soil models as described previously.

### 12.3.4.1.1 Broms Method for Cohesive Soils

The maximum soil resistance per unit length of shaft in cohesive soils is taken as 9 times the cohesion (undrained shear strength) times the shaft diameter, with an exclusion zone in the top 1.5 shaft diameters as illustrated on Figure 12-36.

In order to achieve horizontal force and moment equilibrium, the portion of the earth pressure in the upper portion of the shaft will oppose the applied shear force, and the portion of the earth pressure at the base of the diagram will act as shown in order to restrain the shaft toe. The resulting earth pressure, shear, and moment diagrams would be as shown on Figure 12-37.

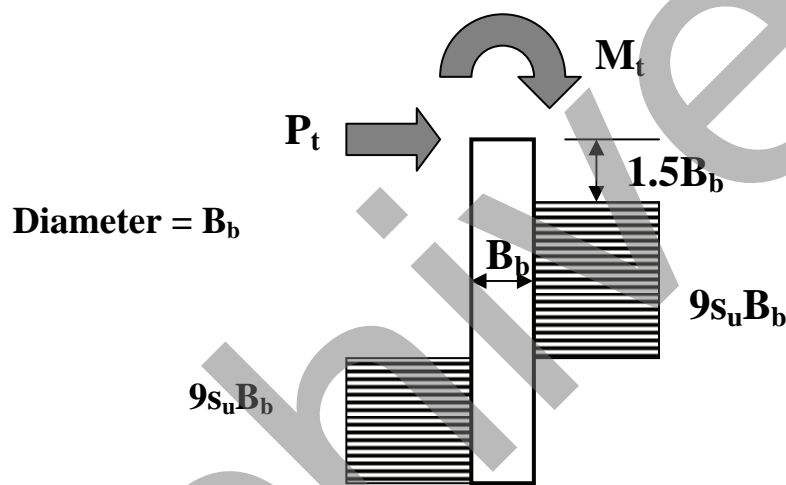


Figure 12-36 Broms Earth Pressures for Cohesive Soils

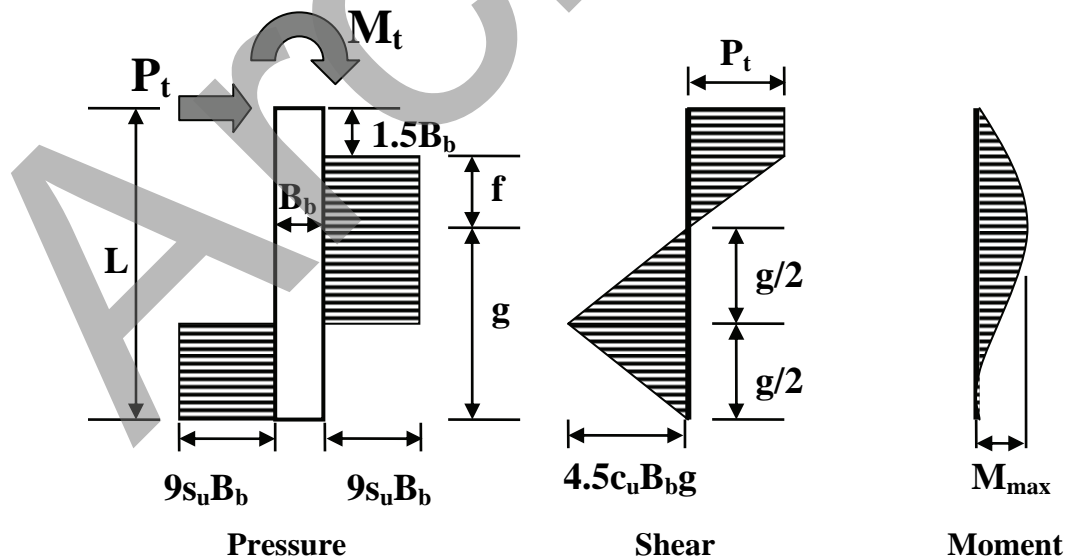


Figure 12-37 Broms Pressure, Shear, Moment Diagrams for Cohesive Soils

The point of zero shear, and thus the point of maximum moment, occurs at a depth,  $f$ , below the top of the uppermost earth pressure diagram as shown on Figure 12-37. In order to satisfy horizontal force equilibrium about that point, the earth pressures below the point of zero shear must sum to zero, and therefore the earth pressures on each side of the shaft over the region labeled “ $g$ ” must be equally divided on each side of the shaft. The crossover pressures result in the triangular shape of the shear diagram over this region with the peak at  $g/2$  as shown. Note that this simplified diagram inherently assumes that the shaft rotates about the point at  $g/2$  where the earth pressures cross the shaft axis, and that the full earth pressure is mobilized immediately above and below this point even though the displacement must be extremely small near the point of rotation. In order to satisfy moment equilibrium, the resultant moment due to the earth pressures acting on the region  $g$  below the point of zero shear must equal the maximum moment, which is the moment due to the forces and earth pressures above the point of zero shear.

From the diagrams shown on Figure 12-37, the following equations are obtained:

$$P_t = 9s_u B_b f \quad 12-15$$

Therefore:

$$f = P_t / 9s_u B_b \quad 12-16$$

Maximum moment:

$$M_{\max} = M_t + P_t(f + 1.5B_b) - (9s_u B_b f^2 / 2) \quad 12-17$$

Determine  $g$  from  $M_{\max}$ :

$$M_{\max} = 4.5s_u B_b g^2 / 2 \quad 12-18$$

Therefore:

$$g = [2M_{\max} / 4.5s_u B_b]^{1/2} \quad 12-19$$

and the minimum length of the shaft is then:

$$L \geq 1.5B_b + f + g \quad 12-20$$

As an example of the Broms method, consider the example problem of 12.3.3.3.4, shown on Figure 12-21. Recall that the factored loads at the top of the shaft were 40 kips shear plus 800 kip-ft moment. Using a resistance factor of 0.4 for the geotechnical strength limit state analysis with Broms method, the shaft must provide a nominal resistance of 100 kips shear plus 2000 kip-ft moment (factored loads / resistance factor).

First determine the required length of the shaft to satisfy the geotechnical strength requirements (Block 10.3 from the flow chart in Figure 12-13). The cohesive soil in the example problem has an undrained shear strength of 15 psi, therefore for the trial shaft diameter of 4 ft, the point of zero shear and maximum moment occurs at:

$$f = P_t / 9s_u B_b = 100 \text{ kips} / [(9)(15 \text{ psi} / 1000)(48 \text{ in})] = 15.43 \text{ inches} \quad 12-21$$



$$\begin{aligned}
 M_{\max} &= M_t + P_t(f + 1.5B_b) - (9s_u B_b f^2/2) \\
 &= 2000\text{k-ft}(12\text{in/ft}) + 100\text{k}(15.43+72)\text{in.} - (9)(15/1000)(48)(15.43)^2/2 \\
 &= 31,972 \text{ inch-kips}
 \end{aligned}
 \tag{12-22}$$

$$g = [2M_{\max} / 4.5s_u B_b]^{1/2} = [2(31,972) / (4.5)(15/1000)(48)]^{1/2} = 140.5 \text{ inches}
 \tag{12-23}$$

$$L \geq 1.5B_b + f + g = 72 + 15.43 + 140.5 = 228 \text{ inches} = 19 \text{ feet}
 \tag{12-24}$$

Recall that the analysis using the p-y method suggested that a 15-ft deep shaft was slightly too short and a 20-ft deep shaft satisfied the geotechnical strength requirements. Note also that the p-y method was performed using a resistance factor of 0.67 and the Broms using a resistance factor of 0.4. Note that the resistance factor for geotechnical strength only affects the required embedment length for this limit equilibrium analysis of overturning stability.

For structural strength requirements (Block 10.4), the maximum moment is computed using the factored loads of 40 kips shear + 800 kip-ft moment. For this load condition:

$$f = P_t/9s_u B_b = 40\text{kips}/[(9)(15\text{psi}/1000)(48\text{in})] = 6.17 \text{ inches}
 \tag{12-25}$$

$$\begin{aligned}
 M_{\max} &= M_t + P_t(f + 1.5B_b) - (9s_u B_b f^2/2) \\
 &= 800\text{k-ft}(12\text{in/ft}) + 40\text{k}(6.17+72)\text{in.} - (9)(.015)(48)(6.17)^2/2 \\
 &= 12,603 \text{ inch-kips} = 1,050 \text{ kip-ft}
 \end{aligned}
 \tag{12-26}$$

Note that the computed maximum moment using the p-y method was 873 kip-ft, somewhat less than the 1,050 kip-ft value in Equation 12-26. The value computed using the Broms method is affected by the assumed exclusion zone of 1.5 B<sub>b</sub> used on the pressure diagram.

#### 12.3.4.1.2 Broms Method for Cohesionless Soils

The maximum soil resistance per unit length of shaft in cohesionless soils is assumed to be three times the Rankine passive earth pressure times the shaft diameter. Thus, at a depth, z, below the ground surface the soil resistance per unit length of shaft, p<sub>z</sub>, can be obtained as follows:

$$p_z = 3B_b \sigma' K_p
 \tag{12-27}$$

$$K_p = \tan^2(45+\phi/2)
 \tag{12-28}$$

Where:

- $\sigma'$  = Effective vertical stress at depth z, =  $\gamma z$
- $\gamma$  = Unit weight of soil (use buoyant weight below water)
- $K_p$  = Rankine coefficient of passive earth pressure
- $\phi$  = Angle of internal friction of soil

The earth pressure diagram used for design is illustrated on Figure 12-38. The passive earth pressure should actually cross the vertical axis at the point of rotation, and the pressures below the point of rotation

should act in the same direction as the load. However, as a simplification, the pressure diagram is taken as shown and the portion on the left hand side is replaced by a concentrated force at the bottom of the shaft (in a manner similar to the simplified earth support method used for walls and described in Section 12.3.5). With uniform soil of weight  $\gamma$ , the vertical stress  $\sigma'$  at the base of the shaft at depth  $L$  will be  $\gamma L$  and the passive earth pressure at the base of the triangular pressure diagram will be  $3B_b\gamma LK_p$ .

Requirements of overall moment equilibrium are applied in order to determine the minimum length of the shaft,  $L_{min}$ , to satisfy geotechnical strength requirements. At the base of the shaft:

$$\begin{aligned}\Sigma M_b = 0 &= M_t + P_t L_{min} - 3B_b\gamma L_{min}K_p(L_{min}/2)(L_{min}/3) \\ 0 &= M_t + P_t L_{min} - \frac{1}{2}B_b\gamma L_{min}^3 K_p\end{aligned}\tag{12-29}$$

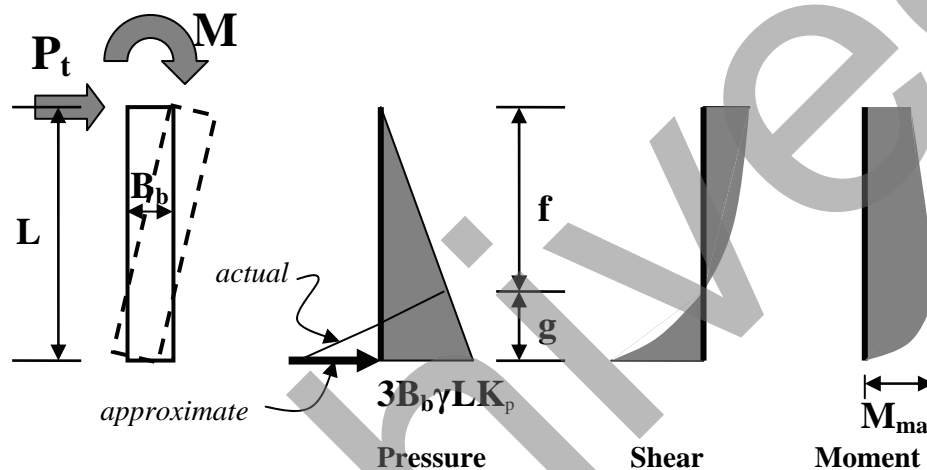


Figure 12-38 Broms Pressure, Shear, Moment Diagrams for Cohesionless Soils

The solution of the cubic Equation 12-29 provides  $L_{min}$ .

The point of zero shear, and thus the point of maximum moment, occurs at a depth,  $f$ , at which point the passive pressure is  $3B_b\gamma fK_p$ , so:

$$P_t = 3B_b\gamma fK_p(f/2) = 1.5B_b\gamma f^2 K_p\tag{12-30}$$

$$f = [P_t/(1.5B_b\gamma K_p)]^{1/2}\tag{12-31}$$

Maximum moment:

$$M_{max} = \Sigma M_f = M_t + P_t(f) - (\frac{1}{2}B_b\gamma f^3 K_p)\tag{12-32}$$

As an example of the Broms method in cohesionless soils, consider the example problem in the previous section with sand instead of clay soil. The sand is submerged, with a buoyant unit weight,  $\gamma_b$  of 60 pcf and  $\phi = 32^\circ$ . Recall that the factored loads at the top of the shaft were 40 kips shear plus 800 kip-ft moment. Using a resistance factor of 0.4 for the geotechnical strength limit state analysis with Broms

method, the shaft must provide a nominal resistance of 100 kips shear plus 2000 kip-ft moment (factored loads / resistance factor).

With  $\phi = 32^\circ$ ,

$$K_p = \tan^2(45^\circ + 32^\circ/2) = 3.25 \quad 12-33$$

and a trial shaft diameter of 4 ft, the required embedment to satisfy geotechnical strength (Block 10.3) can be determined using equations for moment equilibrium at the base:

$$\begin{aligned} \Sigma M_b = 0 &= M_t + P_t L_{\min} - \frac{1}{2} B_b \gamma L_{\min}^3 K_p \\ &= 2000 \text{k-ft} + 100 \text{k}(L_{\min}) - \frac{1}{2}(4 \text{ft})(0.060 \text{kcf}) L_{\min}^3 (3.25) \\ &= 2000 + 100 L_{\min} - 0.39 L_{\min}^3 \end{aligned} \quad 12-34$$

Solution of this equation yields  $L_{\min} \geq 22.1$  ft.

For structural strength requirements, the maximum moment is computed using the factored loads of 40 kips shear + 800 kip-ft moment. For this load condition:

$$f = [P_t / (1.5 B_b \gamma K_p)]^{1/2} = [(40 \text{k}) / ((1.5)(4 \text{ft})(0.06 \text{kcf})(3.25))]^{1/2} = 5.85 \text{ ft} \quad 12-35$$

$$\begin{aligned} M_{\max} = \Sigma M_f &= M_t + P_t(f) - (\frac{1}{2} B_b \gamma f^3 K_p) \\ &= 800 \text{k-ft} + (40 \text{k})(5.85 \text{ft}) - (\frac{1}{2})(4 \text{ft})(0.06 \text{kcf})(5.85)^3 \text{ft}^3 (3.25) \\ &= 956 \text{ kip-ft} \end{aligned}$$

### 12.3.5 Design of Drilled Shaft Walls

Drilled shaft walls may be constructed as overlapping secant shafts, as tangent shafts, or as a soldier pile wall (shaft) wall (Figure 12-39). A soldier pile wall has space between the shafts that may or may not contain lagging or panels; if the shafts are spaced relatively closely together, the soil may arch between shafts and may be covered with a surface panel or shotcrete to provide a surface finish and protection from erosion. Secant shafts include combinations of primary/secondary shafts, in which the secondary shafts are constructed of unreinforced concrete, followed soon after by the primary (reinforced) shafts. In some cases the secondary shafts may be constructed using lower strength concrete. Tangent shafts are normally used in situations where groundwater is less of a concern, since the space between shafts is not sealed and seepage through the joint may occur. All types of drilled shaft walls can be covered with a curtain wall or surfacing for aesthetics, and may include a drainage layer between the surface finish and the joints between shafts, or gravel columns behind the joints combined with horizontal relief holes through the joints. Some examples of drilled shaft walls were illustrated in Section 12.2.5.

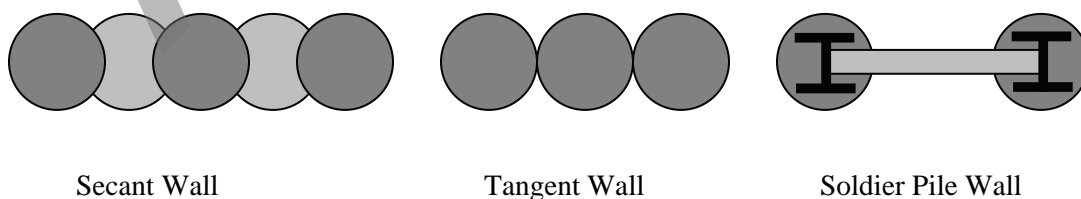


Figure 12-39 Secant, Tangent, and Soldier Pile Walls

Drilled shaft walls are typically considered for applications when a cut is to be made and conditions require a wall that can be constructed in advance of the cut. The soldier pile walls may be constructed with steel sections and panels extending above the top of the shaft to support backfill above the top of the shaft.

This section describes a simple approach for design of walls constructed as a single row of drilled shafts. AASHTO Section 11.8 for nongravity cantilevered walls applies to the design of drilled shaft walls. The design of a drilled shaft foundation as a footing for a conventional gravity or semi-gravity cantilever wall may be accomplished using the concepts outlined in Section 12.3.4.

For design of cantilever tangent pile or secant pile walls for overturning, the conventional earth support methods may be used as is commonly used for sheet pile walls. Similar methods for anchored walls are available, and are described in FHWA-NHI-99-025 by Munfakh et al, (1999).

### 12.3.5.1 Earth Pressures

AASHTO Section 3.11 describes earth pressure forces for design of permanent walls. Lateral earth pressure is assumed to be linearly proportional to the depth below the ground surface, as:

$$p = k\gamma_s z \quad 12-36$$

where:

- $p$  = lateral earth pressure
- $k$  = coefficient of lateral earth pressure
- $\gamma_s$  = soil unit weight
- $z$  = depth below ground surface

The coefficient of lateral earth pressure,  $k$ , may be taken as the active earth pressure coefficient for soil forces acting behind the wall and as the passive earth pressure coefficient for the soil resisting lateral displacement for typical drilled shaft walls that are not structurally restrained against lateral movement.

For walls which may not deflect sufficiently to reach active conditions, such as a wall in a cut which is braced across the top, at-rest lateral earth pressures may be used. At-rest earth pressures are larger than active earth pressures, and may be computed as:

$$k_o = (1 - \sin \phi'_f)(OCR)^{\sin \phi'_f} \quad 12-37$$

where:

- OCR = overconsolidation ratio
- $\phi'_f$  = effective angle of internal friction

Active earth pressures are derived from the Coulomb earth pressure theory including wall friction. For most simple wall applications, the active lateral earth pressure coefficient will be used and may be taken as:

$$k_a = \frac{\sin^2(\theta + \phi'_f)}{\Gamma [\sin^2 \theta \sin(\theta - \delta)]} \quad 12-38$$

in which:

$$\Gamma = \left[ 1 + \sqrt{\frac{\sin(\phi'_f + \delta) \sin(\phi'_f - \beta)}{\sin(\theta - \delta) \sin(\theta + \beta)}} \right]^2 \quad 12-39$$

Where:

- $\delta$  = Friction angle between backfill and wall
- $\beta$  = Angle of backfill with respect to horizontal
- $\theta$  = Angle of back face of wall to the horizontal (normally 90°) for Drilled shafts
- $\phi'_f$  = Effective angle of internal friction

These variables are illustrated on Figure 12-40. The term “backfill” is used to indicate the soils in the active zone behind the wall, although with a drilled shaft wall this soil is normally in-situ material.

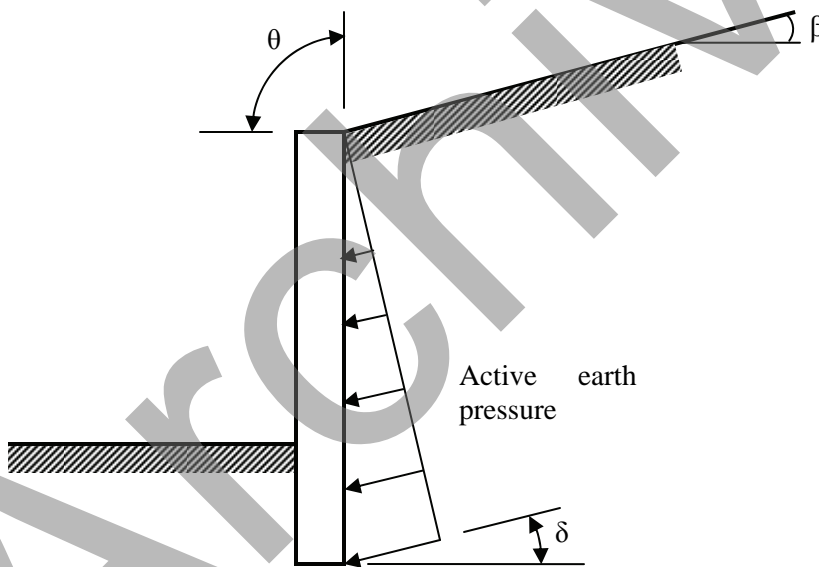


Figure 12-40 Geometry for Drilled Shaft Wall

Suggested values for friction angles provided on AASHTO Table 3.11.5.3-1 from the U.S. Dept. of the Navy (Design Manual 7.02, 1986) for mass concrete on foundation materials are listed in Table 12-4.

**TABLE 12-2 FRICTION ANGLE FOR MASS CONCRETE AGAINST SOIL**

Interface Materials	Friction Angle, $\delta^\circ$	Coefficient of Friction, $\tan \delta$
Clean sound rock	35	0.70
Clean gravel, gravel-sand mixtures, coarse sand	29 to 31	0.55 to 0.60
Clean fine to medium sand, silty medium to coarse sand, silty or clayey gravel	24 to 29	0.45 to 0.55
Clean fine sand, silty or clayey fine to medium sand	19 to 24	0.34 to 0.45
Fine sandy silt, nonplastic silt	17 to 19	0.31 to 0.34
Very stiff and hard residual or preconsolidated clay	22 to 26	0.40 to 0.49
Medium stiff and stiff clay and silty clay	17 to 19	0.31 to 0.34

The values cited above are intended for mass concrete cast against the soil or rock foundation materials listed, but should be suitable for cast-in-place drilled shafts so long as the shaft/soil interface was relatively rough. Some construction techniques might result in lower sidewall friction, such as the use of smooth wall permanent or temporary casing, or bentonite slurry construction where the exposure to slurry materials is likely to exceed four hours after completion of drilling. If these conditions are likely, the designer should use reduced values such as those associated with steel or precast concrete against soil as outlined on AASHTO Table 3.11.5.3-1.

Although silts and clays are generally considered unsuitable for use as retaining wall backfill materials, drilled shaft walls would be used in situations where the wall is constructed into the existing subsurface where the native soil is left in place. Thus, the designer is faced with the need to estimate strength properties of soils *in-situ* rather than for backfill materials over which there is some control of the selection and compaction of these materials.

Long-term earth pressures from clays and plastic silts acting on permanent structures will generally be controlled by the effective stress strength properties of these soils. However, for soft to medium stiff clays, a check of short-term loading conditions should be made using the undrained (total stress) strength properties. Although much of the design of drilled shaft foundations for axial and lateral loads is based on undrained shear strength in clays, it is necessary to measure or estimate effective Mohr-Coulomb strength properties for long-term drained conditions. Even relatively stiff clays can have  $\phi'$  values of less than  $20^\circ$  under drained conditions if the clay is relatively plastic. Triaxial tests on overconsolidated clays may indicate the presence of an effective cohesion,  $c'$ , but the cohesion exhibited by the soil mass may be questionable if a secondary structure of slickensides or fissures is present within the clay. Information on the evaluation of effective stress strength properties is described in Chapter 3 of this manual, and covered in Chapter 10 of the AASHTO design code.

If the wall does not provide adequate drainage to prevent water pressure from accumulating behind the wall, then the effect of hydrostatic water pressure must be added to that of earth pressure (with submerged unit weights for earth pressure).

Resistance to lateral earth pressure forces on the wall is provided by passive earth pressure acting against the wall below the cut. For passive earth pressure, large values of wall friction with a wedge-type solution derived from Coulomb theory can be unconservative and therefore it is recommended that wall friction be taken as zero. The ground surface below the wall will generally be nearly horizontal, or in some cases may slope downward away from the wall. With zero friction on a vertical wall and a horizontal design grade, the passive earth pressure coefficient may be computed using the following simple equation:

$$k_p = \tan^2 \left( 45 + \frac{\phi'_f}{2} \right) \quad 12-40$$

With a sloping ground surface at design grade, the passive earth pressure coefficient is:

$$k_p = \frac{\sin^2(90^\circ + \phi'_f)}{\left[ 1 - \sqrt{\frac{\sin(\phi'_f)\sin(\phi'_f - \beta)}{\sin(90^\circ - \beta)}} \right]^2} \quad 12-41$$

where:

$\beta$  = angle of soil surface (+ is down) with respect to horizontal  
 $\phi'_f$  = effective angle of internal friction

The resulting earth pressure below the design grade elevation is the passive earth pressure below the cut minus the active (or at-rest, if appropriate) earth pressure below the ground surface on the back side of the wall. In some cases the design grade elevation may be below the finished grade elevation to allow for erosion, utility excavations, or other contingency issues. Discounted passive resistance below the finished grade elevation should be established based upon a rational assessment of local and/or project-specific conditions.

In soils which are demonstrated to have effective cohesion, such as rock, strongly cemented soils, or strong clays without fissures, the effective cohesion,  $c'$  can be included. The cohesion added to the passive earth pressure resistance is:

$$p_p = k_p \gamma_s z + 2c' \sqrt{k_p} \quad 12-42$$

The cohesion added to the active earth pressure resistance is:

$$p_a = k_a \gamma_s z - 2c' \sqrt{k_a}; \quad p_a \geq 0 \quad 12-43$$

The effect of cohesion on the active pressure side could result in negative values (tension!) at shallow depths, which would imply that the soil is exerting tension onto the wall. Such a condition is not reasonable and so a lower bound value of 0 is applied to  $p_a$ . Note also that fissures or cracks in the soil at shallow depths can fill in with sediments or water and result in lateral stress on the wall, and weathering of soils at shallow depths can degrade the cohesion. For this reason, it is prudent to ignore the cohesion in the backfill soils above the base of the wall.

Where drilled shafts are noncontiguous (as in the case of a soldier shaft wall), it can often be assumed that soil arching will occur in the space between the shafts. In most soils, arching up to a clear distance of two shaft diameters will make the effective width of the shaft up to 3 shaft diameters for estimating passive resistance, but the effective width cannot exceed the center-to-center spacing of the drilled shafts. This width should be reduced if planes or zones of weakness would prevent mobilization of resistance through

this entire width such as in soft clays or in rock or residual soils where vertical fractures or seams are present. On the back side of the wall, active (or at-rest) pressure should be applied continuously above the excavation level, and at one times the shaft diameter below the bottom of the excavation.

### 12.3.5.2 Evaluation of Geotechnical Strength

The analysis of geotechnical strength of a cantilever drilled shaft wall is based on a limit equilibrium analysis of a rigid wall subject to earth pressures as described in the previous section. As illustrated on Figure 12-41, the passive earth pressures below the design grade act to resist lateral forces from the retained soil. In order to satisfy both horizontal force and overturning moment equilibrium, the passive pressure near the toe of the shaft must act on the back side of the wall. As a simplifying approximation, this passive pressure is replaced by a concentrated force, shown as “F” on Figure 12-41. This simplifying assumption is considered sufficient for routine design; more rigorous solutions are described in Earth Retaining Structures Reference Manual, FHWA-NHI-99-025 (Munfakh et al, 1999). The diagram on Figure 12-41 is shown for a profile with two soil layers, soil 1 above the design grade elevation and soil 2 below. A given design profile could be more complex and contain numerous soil layers. Surcharge pressures from surface loads may be added to the active earth pressure diagram.

In order to satisfy force and moment equilibrium, the shaft must be embedded to a depth of at least  $D$  so that the sum of moments about the base is zero.

The current approach suggested in the commentary of Section 11.8.4.1 in AASHTO 4<sup>th</sup> Edition, 2007 is as follows:

- Overturning about the base is computed using the factored active earth pressures, with a load factor,  $\lambda = 1.5$ , applied to the active pressure (or use 1.35 for at-rest pressure).
- Resistance to overturning about the base is computed using factored passive earth pressures, with a resistance factor,  $\phi = 0.75$ , applied to the passive pressure.
- The design minimum embedment depth is taken as the computed value of  $D_o$  required for moment equilibrium, increased by 20%, so  $D = 1.2D_o$ .

An example calculation is provided below for a relatively simple problem.

Consider a drilled shaft tangent wall used to extend a cut section of roadway as illustrated on Figure 12-42. A relatively simple soil profile is composed of stiff sandy clay overlying a dense clayey sand, with groundwater at a depth of about 30 ft below the design grade at the base of the wall. The existing roadway is to be widened while preserving a frontage road at the top of the slope.

The wall will be constructed as a drilled shaft tangent wall in the following manner:

- cut a temporary bench into the existing slope to provide a working platform,
- construct a guidewall for the tangent pile wall
- construct the drilled shaft wall from the bench
- construct the 4-ft extension to the wall atop the drilled shafts
- backfill the top and excavate the cut to final grades
- construct aesthetic surface or curtain wall facing



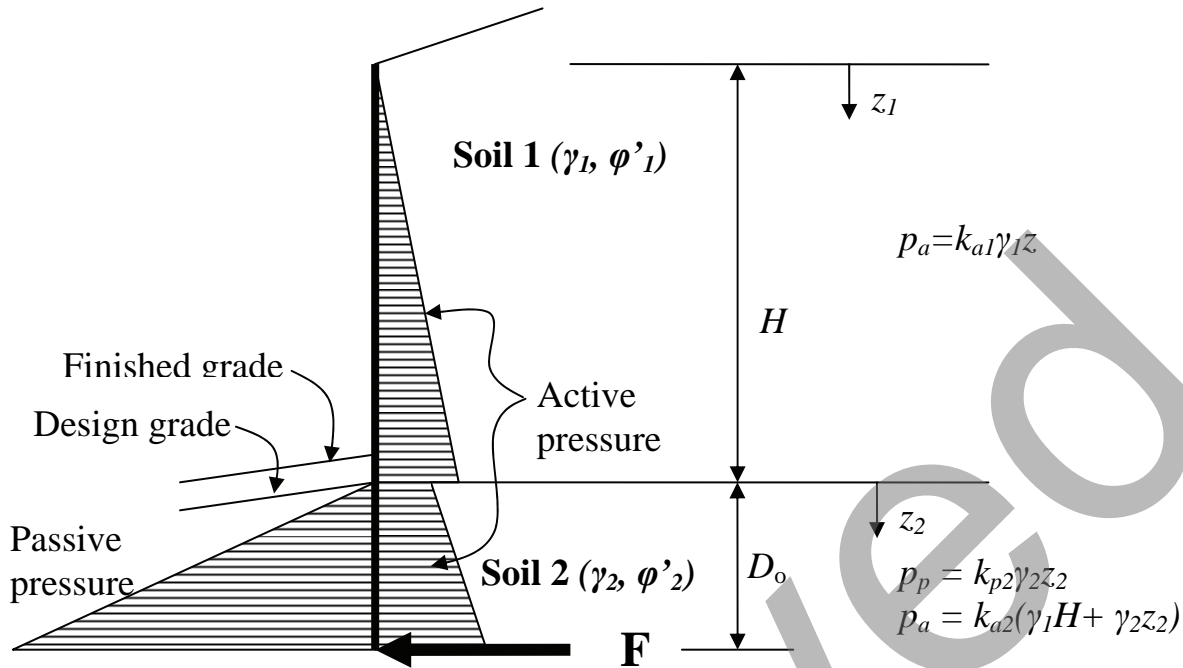


Figure 12-41 Simplified Earth Support Diagram for a Cantilever Wall using Effective Stress Strength

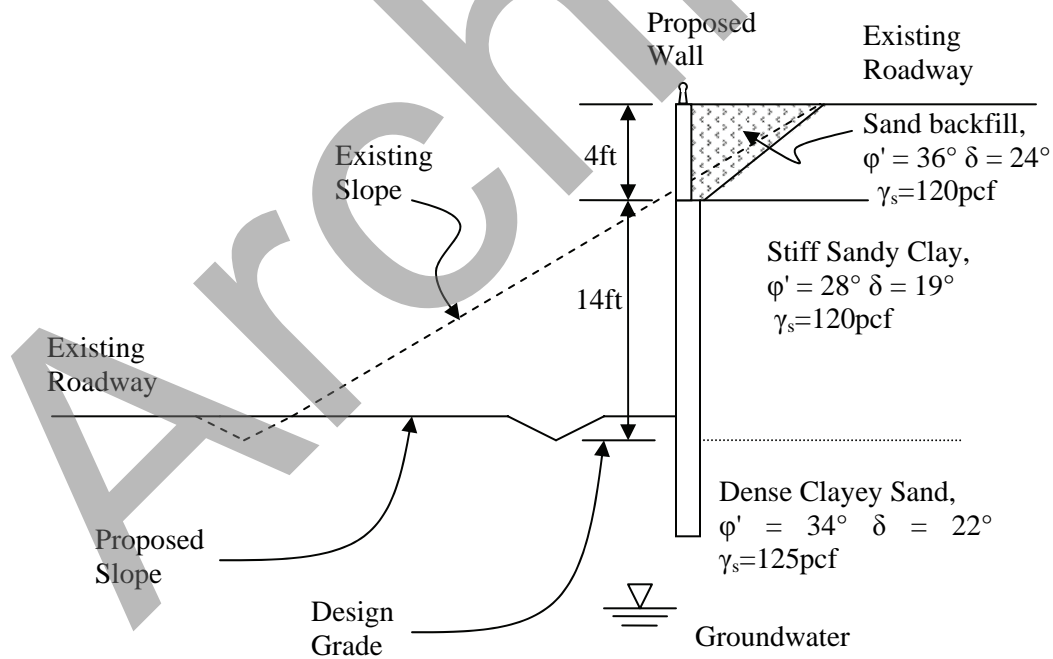


Figure 12-42 Example of Drilled Shaft Wall Problem

For this example, the values of active and passive earth pressure coefficients are computed using Equations 12-38 thru 12-40:

- Sand backfill:

$$\Gamma = \left[ 1 + \sqrt{\frac{\sin(36+24)\sin(36-0)}{\sin(90-24)\sin(90+0)}} \right]^2 = 3.05$$

$$k_a = \frac{\sin^2(90+36)}{3.05[\sin^2 90 \sin(90-24)]} = 0.235$$

- Stiff Sandy Clay:

$$\Gamma = \left[ 1 + \sqrt{\frac{\sin(28+19)\sin(28-0)}{\sin(90-19)\sin(90+0)}} \right]^2 = 2.57$$

$$k_a = \frac{\sin^2(90+28)}{2.57[\sin^2 90 \sin(90-19)]} = 0.321$$

- Dense Clayey Sand:

$$\Gamma = \left[ 1 + \sqrt{\frac{\sin(34+22)\sin(34-0)}{\sin(90-22)\sin(90+0)}} \right]^2 = 2.91$$

$$k_a = \frac{\sin^2(90+34)}{2.91[\sin^2 90 \sin(90-22)]} = 0.254$$

$$k_p = \tan^2\left(45 + \frac{34}{2}\right) = 3.54$$

In order to account for future surcharge pressures atop the backfill, a 250 psf uniform surcharge will be included for design of the wall. The resulting pressure diagram is computed as follows and illustrated in Figure 12-43. For reference,  $z_1$  is taken as the depth below the top of the wall on the backfill side and  $z_2$  is taken as the depth below design grade on the lower side of the wall. Note that a load factor of 1.5 is used with active earth pressure and a resistance factor of 0.75 is used with passive earth pressure resistance.

- At  $z_1 = 0$ ,  $p_a = (1.5)(0.235)(250) = 88$  psf
- At  $z_1 = 4$  ft in sand backfill,  $p_a = (1.5)(0.235)(250+4(120)) = 257$  psf
- At  $z_1 = 4$  ft in sandy clay,  $p_a = (1.5)(0.321)(250+4(120)) = 351$  psf
- At  $z_1 = 18$  ft in sandy clay,  $p_a = (1.5)(0.321)(250+18(120)) = 1160$  psf
- At  $z_1 = 18$  ft in clayey sand,  $p_a = (1.5)(0.254)(250+18(120)) = 918$  psf
- At  $z_1 = 18$  ft,  $z_2 = 0$  ft in sandy clay,  $p_p = 0$
- At  $z_1 > 18$  ft in sandy clay,  $p_a = 918$  psf +  $(1.5)(0.254)(125) = 918$  psf + 47.625 psf/ft
- At  $z_1 > 18$  ft ( $z_2 > 0$  ft) in sandy clay,  $\phi p_p = (0.75)(3.54)(125) = 331.875$  psf/ft

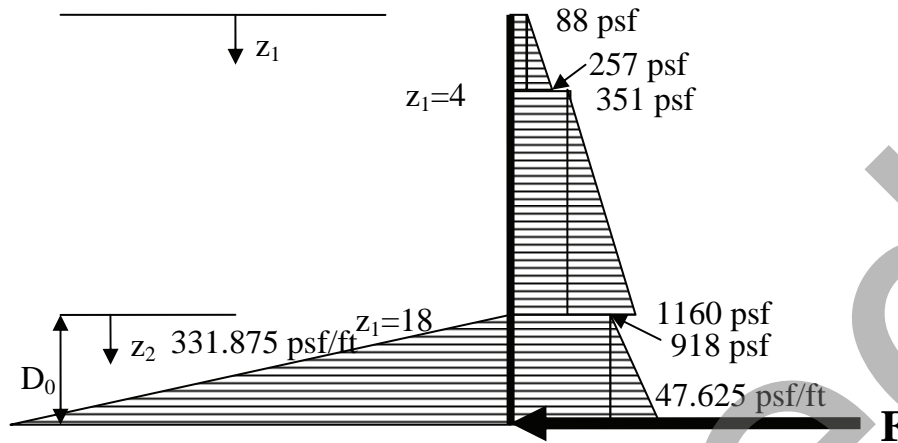


Figure 12-43 Earth Pressure Diagram for Drilled Shaft Wall Example Problem

In order to sum moments about the base of the wall, compute the resultant force due to each triangular and rectangular portion of the pressure diagram. The resultant force of the triangular parts acts at  $1/3$  height of the triangle, and the resultant force of the rectangular parts acts at mid-height of the rectangle.

$$\begin{aligned}
 \Sigma M_{\text{base}} = 0 &= (88)(4)(16+D_0) \\
 &+ (257-88)(2)(15.333+D_0) \\
 &+ (351)(14)(7+D_0) \\
 &+ (1160-351)(7)(4.667+D_0) \\
 &+ (918)(\frac{1}{2})(D_0)^2 \\
 &+ (47.625)(\frac{1}{2})(\frac{1}{3})(D_0)^3 \\
 &- (331.875)(\frac{1}{2})(\frac{1}{3})(D_0)^3 \\
 &= 71,641.8 + 11,267D_0 + 459D_0^2 - 47.375D_0^3
 \end{aligned}$$

Solve to find  $D_0 = 22.93$  ft. Therefore,  $D \geq 1.2 D_0 = 27.5$  ft, and the shaft would need to be drilled to a depth of  $27.5 + 18 = 45.5$  ft below the ground surface (top of wall) elevation.

Note that the groundwater elevation was at approximately 30 ft below the final grade, so it is likely that the drilled shaft excavation may not encounter groundwater. Due to the clay content of the sandy soils encountered it may be possible to drill in the dry, but prudent to anticipate the possible need for slurry.

### 12.3.5.3 Evaluation of Structural Strength

Analysis of structural strength of an individual drilled shaft is accomplished as described briefly in this chapter and covered in detail in Chapter 16. The maximum bending moment per unit length of wall (per foot) is computed from the analysis at the point of zero shear, i.e., the point at which the area under the pressure diagram on each side of the wall are in balance. The maximum bending moment in an individual

shaft is equal to the maximum bending moment per unit length of wall times the spacing between reinforced shafts. Note that some walls may include unreinforced shafts (such as the secondary shafts in a secant wall system), and these would not be considered as contributing to the structural strength of the wall.

The load and resistance factors for horizontal earth pressure used for structural design are the same as used for geotechnical strength; as provided in AASHTO Table 3.4.1-2,  $\phi = 0.75$  for passive earth pressure,  $\lambda = 1.5$  for active earth pressure conditions and  $\lambda = 1.35$  if at-rest earth pressures are used.

As an example calculation of maximum bending moment, consider the example problem of the previous section resulting in the pressure diagram illustrated in Figure 12-43. The depth ( $z_2$ ) to the point of zero shear is computed as follows:

$$\begin{aligned}\Sigma F_h = 0 &= (88)(4) \\ &+ (257-88)(2) \\ &+ (351)(14) \\ &+ (1160-351)(7) \\ &+ (918)(z_2) \\ &+ (47.625)(\frac{1}{2})(z_2)^2 \\ &- (331.875)(\frac{1}{2})(z_2)^2 \\ &= 11267 + 918z_2 - 142.125(z_2)^2\end{aligned}$$

Solve to find  $z_2 = 12.70$  ft.

Therefore, the maximum bending moment occurs at a point 12.70 ft below the design grade elevation and the factored earth pressure diagram is used to find the maximum bending moment due to factored loads and the nominal strength requirement for structural design. For this example, the maximum bending moment is:

$$\begin{aligned}\Sigma M_{\max} &= (88)(4)(16+12.70) \\ &+ (257-88)(2)(15.333+12.70) \\ &+ (351)(14)(7+12.70) \\ &+ (1160-351)(7)(4.667+12.70) \\ &+ (918)(\frac{1}{2})(12.70)^2 \\ &+ (47.625)(\frac{1}{2})(\frac{1}{3})(12.70)^3 \\ &- (331.875)(\frac{1}{2})(\frac{1}{3})(12.70)^3 \\ &= 191,723 \text{ ft-lb/ft of wall} = 192 \text{ kip-feet per foot of wall}\end{aligned}$$

Some example designs which might be considered for this wall:

- 36-inch diameter tangent shaft wall, with each shaft reinforced to resist a nominal bending moment of 576 kip-feet.
- 42-inch diameter secant shaft wall, with shafts spaced at 36 inches c-c, and with unreinforced secondary shafts and reinforced primary shafts. Each reinforced shaft would be required to

provide structural strength for a 6-ft section of wall and therefore must be reinforced to resist a nominal bending moment of 1152 kip-ft.

The reinforcement required to provide the nominal moment resistance for each of the two cases above can be computed using the methods described in Chapter 16.

#### 12.3.5.4 Evaluation of Deformations

The magnitude of movement required to reach the minimum active pressure or the maximum passive pressure is a function of the wall height and the soil type. Some typical values of these movements are given in Table 12-3, which is reproduced from AASHTO Table C3.11.1-1.  $\Delta$  is the movement at the top of the wall required to reach minimum active or maximum passive pressure by tilting or lateral translation, and H is the height of wall above finished grade. These values are estimated for typical retaining walls with compacted backfill; it is possible that some contribution to movement is associated with compaction of the backfill near the wall and therefore movement for a drilled shaft wall constructed into in-situ soil strata could be lower. However, flexure of the drilled shaft wall may increase the lateral displacement relative to that of a more nearly rigid structure.

**TABLE 12-3 APPROXIMATE VALUES OF RELATIVE MOVEMENTS REQUIRED TO REACH ACTIVE OR PASSIVE EARTH PRESSURE CONDITIONS (Clough and Duncan, 1991).**

Type of Backfill	Values of $\Delta/H$	
	Active	Passive
Dense sand	0.001	0.01
Medium dense sand	0.002	0.02
Loose sand	0.004	0.04
Compacted silt	0.002	0.02
Compacted lean clay	0.010	0.05
Compacted fat clay	0.010	0.05

Note that shrink/swell movements of plastic clays associated with wet/dry cycles can affect wall movements in these soils. In addition, walls designed for active earth pressures in clay soils tend to accumulate additional movement due to creep.

The displacements indicated in Table 12-3 are the displacements required to develop active (or passive) earth pressures. These do not represent the anticipated displacement of the wall. If computed displacements appear to be inadequate to develop active earth pressures, then it is possible that higher earth pressures associated with at-rest conditions may apply.

In order to estimate deflections at the Service Limit State, an earth pressure diagram should be developed using service limit load and resistance factors; for the Service Limit State, the load and resistance factors,  $\lambda$  and  $\phi$ , are both equal 1.0. For cantilever walls, displacements can be estimated assuming that the drilled shaft acts as a beam which is fixed at the base, with the base taken at the point of zero shear using the earth pressure diagram associated with the Service Limit State and the beam subject to a distributed load equal to the earth pressures multiplied by the effective area of the drilled shaft. For this condition, it may be more appropriate to use at-rest earth pressures rather than active earth pressures unless computed displacements indicate that sufficient movement occurs to develop an active earth pressure condition.

The inclusion of transient surcharge loads for computation of lateral displacement is subject to the designer's judgment regarding the nature of any such loads and potential effect on long term lateral displacements.

#### **12.3.5.5 Seismic Design**

The effect of earthquake loading is most often evaluated using a pseudo-static approach in which earth pressures are amplified due to horizontal accelerations of the retained soil mass. Wall inertia effects are small by comparison and may be ignored. For this extreme event limit state, AASHTO recommends the use of a resistance factor of 1.0 and load factor of 1.0 on earth pressures induced by seismic loading. The equivalent static earth pressure forces may be estimated using the pseudo-static approach developed by Mononobe and Okabe and described in Appendix A to Chapter 11 of AASHTO 4<sup>th</sup> Edition, 2007.

#### **12.3.6 Design for Drilled Shaft Foundations with Lateral Movement of Soil Mass**

Drilled shaft foundations may be subjected to lateral movements of a soil mass for some conditions such as a foundation subject to lateral spreading during earthquake-induced liquefaction. In some cases, drilled shafts may be used with the intent to restrain the lateral movement of a soil mass as a remedial measure for an unstable slope. In these cases, the unstable soil mass can load the foundation with pressures as high as the maximum passive earth pressure within the shifting soil mass. Drilled shafts designed to resist these lateral pressures must be embedded below the unstable soil mass to sufficient depth for geotechnical strength, and must be designed with sufficient structural strength to resist the stresses imposed by the unstable soil mass.

Lateral earth pressures above the potential sliding surface may act on the exposed drilled shaft and the resultants from these pressures can be used to compute horizontal shear and overturning moment at the sliding surface. The drilled shaft below the sliding surface is then analyzed for geotechnical and structural strength and deformations using one of the methods described in previous sections. For groups of drilled shafts, possibly including an embedded cap, the resultant forces on the group are computed with the inclusion of group effects as described in Chapter 14.

In general, one would not design a structural foundation within an unstable slope without including remedial measures to improve overall stability of the slope. However, extreme event conditions such as liquefaction-induced lateral spreading may be a condition for which the foundation is designed to resist lateral forces from an overall stability failure. Note that liquefaction-induced lateral spreading may produce relatively low passive horizontal pressures within the liquefaction zone, but an intact overlying soil mass can contribute significant lateral pressures.

Lateral earth pressures can be as high as passive earth pressure for a drilled shaft within a large unstable soil mass. However, a lesser restraining force provided by a drilled shaft foundation may be sufficient to prevent a fully developed slope failure. Analyses of overall slope stability may be performed using a limit equilibrium approach such as the Modified Bishop, Simplified Janbu, or Spencer methods with an equivalent horizontal restraining force applied to the slope. In this case the lateral force that must be provided by the foundation above the slip surface (and transferred to the soil or rock below the slip surface) would be the lesser of the passive lateral earth pressure or the restraining force necessary for overall stability of the sliding soil mass.

AASHTO Section 11.6.2.3 requires that the evaluation of overall stability should be performed with a resistance factor of 0.65 in cases where the slope contains or supports a structural element.

Another approach to analysis of drilled shafts with lateral movement of a soil mass is to use the p-y method with a displacement offset of the p-y curves above the slip plane. In this manner, the analysis of shear resistance and bending moments in the shaft can be evaluated as a function of lateral soil movement above the slip plane. This approach can be particularly useful where drilled shafts are designed as a remedial slope stability measure and the slip plane is deep below the soil surface. The drilled shafts effectively act as shear dowels across the slip plane.

The results of the analyses shown in Figure 12-44 demonstrate the approach for a hypothetical slope failure composed of a deposit of clay overlying a rock formation, with the slip plane at the soil/rock interface. The behavior of the drilled shaft extending through the soil stratum into the rock is modeled by applying an offset of up to 3 inches to the p-y curves in the soil above the failure surface. The offset is applied with a transition to 0 inches offset over a thickness of 18 inches labeled in the figure as “shear zone”. As the soil movement increases, the shear and bending moment forces in the shaft increase as illustrated by the shear and moment curves for different soil displacements in Figure 12-44. The curves shown include nonlinear soil vs displacement relationships via the p-y curves, and nonlinear bending stiffness (moment-curvature) of the reinforced concrete drilled shaft as described in Section 12.3.3.2.

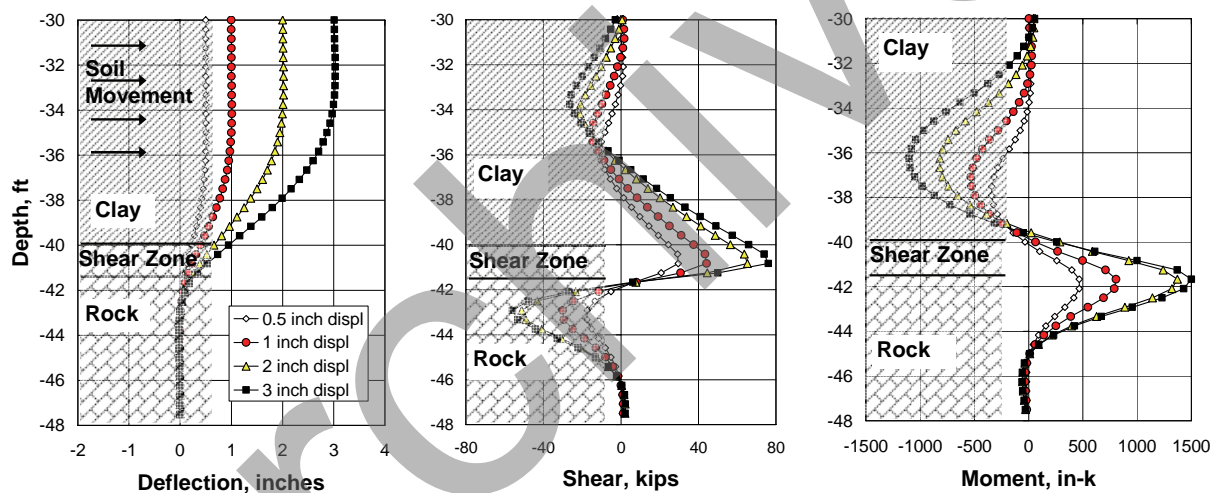


Figure 12-44 Analysis of Drilled Shafts in Moving Soil (Loehr and Brown, 2007)

This analysis approach provides a means to evaluate:

- Geotechnical strength of the socket below the shear plane. The shaft must extend to sufficient depth to provide the required shear force for overall stability.
- Geotechnical strength of the overall stability of the slope. The shear force provided by the drilled shaft can be applied as a restraining force for the limit equilibrium analysis of overall stability.
- Structural strength of the drilled shaft. The bending moments in the shaft associated with the shear force provide a means to evaluate structural strength at the conditions required for overall stability.

- Deformations of the slope. Estimates of slope movement associated with a remedial repair of a slope with marginal overall stability are likely to be approximate at best. The analysis provides a rational means of relating the restraining shear force to deformations of the slope.

As outlined above, a successful remedial design includes the restraining shear forces required to stabilize a slope mobilized as a shear force in the shaft by the shaft through the soil movement, and the maximum shear force which can be mobilized is at a magnitude which satisfies structural strength conditions for the shaft.

Note that the p-y criteria in widespread use for laterally loaded drilled shafts are generally based on short term loading conditions; in clay soils, it is likely that some creep-induced movements will relax soil pressures and/or increase soil displacements with time. However, the analyses of shear and moment in the drilled shaft are not very sensitive to the p-y response of the soil for a deep failure surface.

Additional details of the use of analysis of slopes using the p-y method are provided by Loehr and Brown (2007).

Lateral loading due to liquefaction-induced instability in a soil mass presents a special problem, in that the p-y curves for some soil layers may be affected by the high transient pore pressures. Methods for the evaluation of lateral spreading is described in MCEER/ATC-49-1, Liquefaction Study Report (2003), and this document provides a recommended step-by-step design approach. The most precise method of analysis that ensures compatibility of deformations between the soil and piles is identified as the p-y method using a computer program with the soil spreading deformations imposed onto the p-y springs as outlined above and illustrated in Figure 12-45.

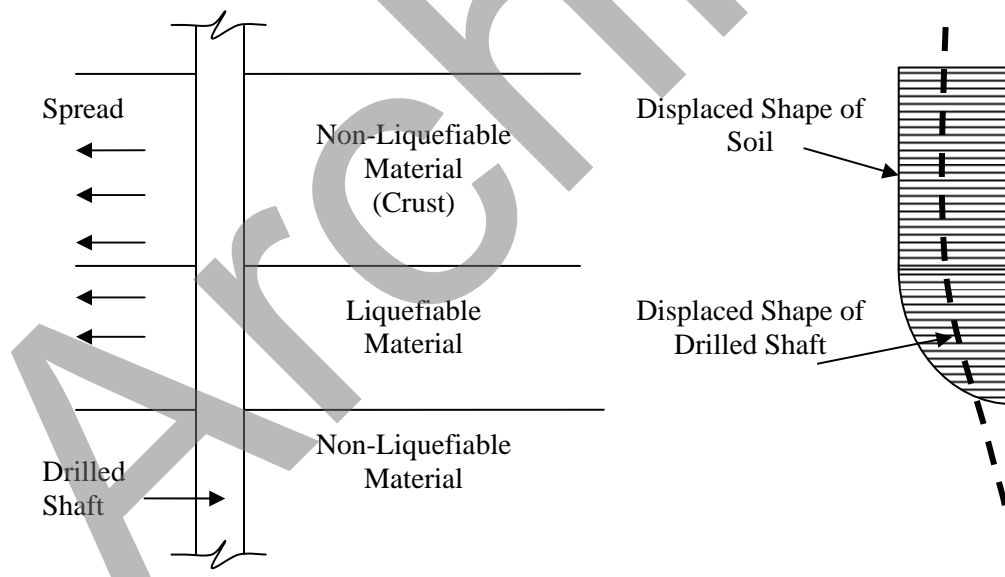


Figure 12-45 Spreading that Displaces Foundation with Soil

The analysis of lateral spreading is normally de-coupled from the analysis of foundation response due to structure inertial loading. This approach seems reasonable because the structural forces occur during the seismic event while the lateral spreading forces due to ground instability would typically be expected to



occur shortly afterward. However, recent centrifuge model tests by Brandenberg et al (2007) suggest that some inertial forces from the structure may contribute simultaneously with lateral spreading forces in some instances.

For a bridge structure founded on drilled shafts subject to liquefaction-induced lateral spreading, several issues must be considered:

- The magnitude of the lateral soil movement at the foundation location must be estimated, although at very large (unlimited) movements the load applied to the foundation approaches a passive earth pressure limit.
- The boundary conditions (restraint) at the top of column or shaft must be estimated. The top of column may be restrained by portions of the bridge structure extending to areas not affected by liquefaction.
- The soil resistance within liquefied zones must be assessed, as the p-y curves will be affected.

The analysis may be conducted as described previously, using a displacement offset applied to the p-y curves so that the soil movements drive the problem. Layers undergoing liquefaction may be modeled by adjusting the soil properties to account for the transient high pore water pressures. The soil undergoing liquefaction is at a residual strength condition. It is possible that overlying soil layers may be unaffected, liquefied, or somewhere in between due to elevated pore water pressures that have not achieved a liquefaction condition. At present, there is not a single consensus approach, but several approaches have been used to model soils for lateral spreading:

The recommendation outlined in the MCEER/ATC-49-1 guidelines is that the liquefied soil layer may be modeled using a soft-clay p-y formulation and assigned an undrained shear strength to approximate the residual strength of the soil (Wang and Reese, 1998). Rollins et al (2005) have measured resistance from large scale pile groups subjected to blast-induced liquefaction and found the soft clay formulation to overestimate the actual soil resistance at deformations up to 6 inches; an alternative p-y formulation is provided in that reference based upon these limited field tests.

Brandenberg et al (2007) obtained good agreement with the results of a series of centrifuge model tests by incorporating liquefaction behavior in sand layers using a p-multiplier of 0.05 and 0.30 in loose and dense sand, respectively. The p-multiplier is a scaling factor which is applied to the soil resistance of a p-y curve. This approach is easily incorporated into existing computer models by adding the p-multiplier in the same way that it would be applied for group effects.

Brown and Camp (2002) obtained similarly good agreement of blast-induced liquefaction of loose to medium dense silty sand and an 8 ft diameter drilled shaft by using a multiplier of 0.15 times the soil unit to model the reduced effective stress associated with the elevated pore water pressures. The effect (reduced maximum soil resistance) is very similar to that developed using a p-multiplier of a similar value.

Ashour and Norris (2003) use an effective stress approach with the strain wedge model to account for the generation of pore pressures and generate p-y curves.

## 12.4 SUMMARY

This chapter outlines methods for the analysis and design of individual vertical drilled shafts for lateral loads, including a simple example. The recommended method uses p-y curves to model the nonlinear relationship of soil resistance as a function of lateral displacement along the length of the shaft. This method has a history of use for transportation and offshore structures, and also provides information needed for structural design of drilled shafts (covered in detail in Chapter 16). The application of the method with LRFD design concepts is outlined, along with some guidelines for selection and use of appropriate p-y soil models for foundations.

In the overall design process, lateral loading conditions often dictate the diameter of the drilled shaft that will be required and therefore a consideration of this aspect of design is typically required early in the planning and preliminary design process. It is possible that lateral load requirements may control drilled shaft length; however, axial load demands are more likely to dictate final tip elevations for drilled shafts as outlined in Chapter 13.

## RESOURCES

*LPILE* and *GROUP* can be obtained from Ensoft, Inc., <http://www.ensoftinc.com/>

*FLPIER* can be obtained from the Bridge Software Institute at the University of Florida, <http://bsi-web.ce.ufl.edu/>

*DFSAP* can be obtained from the Washington State DOT Bridge Office at <http://www.wsdot.wa.gov/eesc/bridge/Software/index.cfm>

## CHAPTER 13

### GEOTECHNICAL DESIGN FOR AXIAL LOADING

With proper design and construction, drilled shafts provide a highly effective system to transmit axial compression and uplift loads to the ground. Design for axial loading requires analysis of strength and service limit states for compression and uplift and may also require evaluation of extreme event limit states, covered in Chapter 15. This chapter presents specific recommendations for design under axial compression and uplift loading through a step-by-step design procedure.

Design methods and equations presented herein are largely consistent with those presented in the AASHTO LRFD Bridge Design Specifications (AASHTO, 2007). The AASHTO specifications are based on the 1999 version of this manual (O'Neill and Reese, 1999). Where research has led to improved or alternative methods, both the updated and previous methods are discussed and compared in Appendix C.

#### 13.1 AXIAL LOAD TRANSFER – BASIC CONCEPTS

The mechanisms of load transfer from a deep foundation to the surrounding ground are fundamental to understanding the basis of design methods for axial loading. The basic load transfer mechanisms were identified through early research on drilled shafts (O'Neill and Reese, 1972) and driven piles (Vesic, 1977). For drilled shafts the general concepts are summarized by Kulhawy (1991) as follows. Figure 13-1 illustrates the load transfer behavior of a drilled shaft of length  $L$  and diameter  $B$  subjected to an axial compression load  $Q_T$  applied to the butt (top) of the shaft (Figure 13-1a). Figure 13-1b shows the general relationship between axial resistance and downward displacement. Three components of resistance are shown: (1) side resistance  $R_s$ , (2) base (tip) resistance  $R_b$ , and (3) combined (total) resistance. Figure 13-1c shows the idealized distribution of axial load as a function of depth ( $z$ ) for different displacements. As axial load on the shaft increases from zero, the shaft displaces downward and side resistance in shear is mobilized (Point A in Figure 13-1b). This transfer of load to the surrounding soil or rock results in decreasing load with depth as shown by the dashed curve in Figure 13-1c. At this point, load is transferred predominantly in side resistance and load transmitted to the base may be small. With increasing load, the full side resistance is mobilized (Point B), typically at a displacement of approximately  $\frac{1}{2}$  inch  $\pm$ . Further increases in load beyond Point B must be resisted by the base, until the maximum base and combined resistances are reached (Point C). The displacement required to mobilize the maximum base resistance varies, but research suggests that maximum resistance is reached at a displacement equivalent to about 4 to 5 percent of the shaft diameter for bearing in cohesive soil or rock and about 10 percent of the shaft diameter for bearing in cohesionless soils. Between Points B and C, side resistance may remain constant or change (increase or decrease) depending upon the stress-strain behavior along the interface between the shaft and soil or rock. In some cases the shaft continues to exhibit increasing resistance with continued downward displacement, thus a well-defined maximum total load is not achieved.

Several important behavioral aspects of drilled shafts are illustrated in Figure 13-1. The first is that side and base resistances develop as a function of shaft displacement, and the peak values of each occur at different displacements. Maximum side resistance occurs at relatively small displacement and is independent of shaft diameter. Maximum base resistance occurs at relatively large displacement and is a function of shaft diameter and geomaterial type. Design for service limit states must, therefore, account for differences in side and base resistance mobilization as a function of axial displacement.

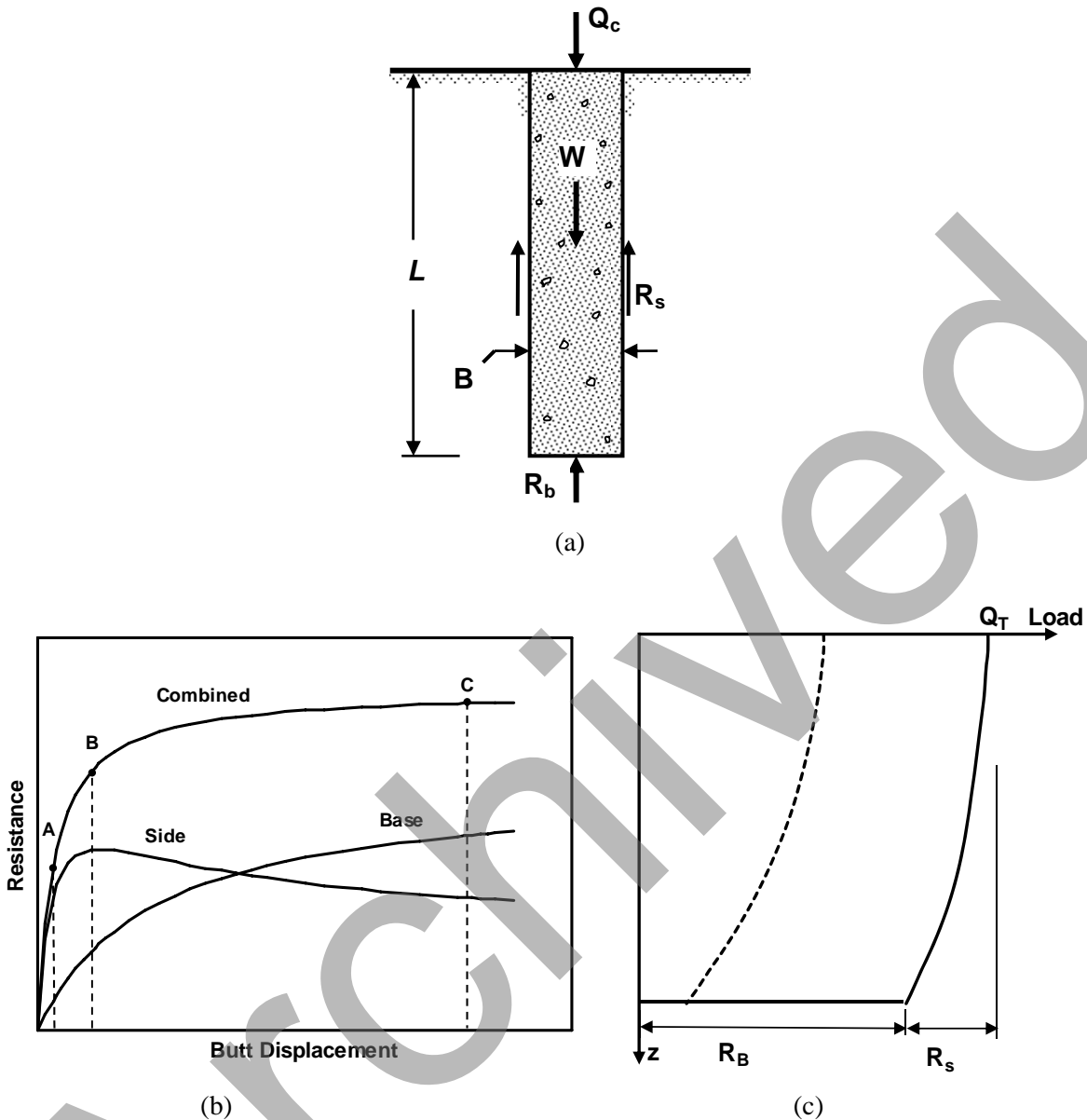


Figure 13-1 Generalized Load Transfer Behavior of Drilled Shaft in Compression

### 13.2 RELATIONSHIP TO OVERALL DESIGN PROCESS

Chapter 11 presents a roadmap for the overall design and construction process, as summarized in the form of the flowchart in Figure 11-1. The information presented in this chapter constitutes a more detailed treatment of Block 11 of Figure 11-1, “Establish Depth and Diameter for Axial Loads”. Several other steps in the overall process are interrelated with design considerations for axial loading and these are discussed in the following.

Block 3 of Figure 11-1 is entitled: “Determine Substructure Loads and Load Combinations at Foundation Level”. This step is carried out in consultation with the project structural engineer and in accordance with AASHTO specifications for design of highway bridges or other applicable design specifications.

AASHTO (2007) identifies axial compression and axial uplift of single drilled shafts as strength limit states to be satisfied and settlement control as a service limit state to be satisfied.

Factored axial force effects for each limit state to be evaluated are communicated by the project structural engineer to the foundation designer, based on structural modeling of the bridge or other structure using the applicable load combinations. As described in Chapter 10, AASHTO (2007) identifies twelve potential limit states, each consisting of different load combinations (see Table 10-2). Factored force effects transmitted to the foundations will vary for each limit state and for various scour conditions and it is important for the foundation designer to understand which limit states and associated axial force effects are applicable to the structure being designed. Not all of the limit states apply in every case.

The service limit state for axial loading is based on settlement criteria for the bridge or other structure. All applicable loads in the Service I Load Combination as specified by AASHTO (2007) are investigated. Most of the load factors are taken equal to unity for the Service I limit state evaluation (see Table 10-3). For drilled shafts in cohesive soils, transient loads can be omitted from settlement analysis, based on the assumption that the transient response of cohesive soils will not result in significant settlement.

Load factors for all limit states are given in Table 3.4.1-1 of the AASHTO specifications (AASHTO, 2007). A partial summary of load factors is also given in Tables 10-3 and 10-4 of this manual.

Block 8 of Figure 11-1 (Define Subsurface Profile for Analysis) involves establishing a design subsurface profile with specific geomaterial properties at each foundation location. Design methods for axial loading require the subsurface profile to be divided into a finite number of layers and a specific geomaterial type assigned to each layer. Block 9 of Figure 11-1 (Define Resistance Factors for Design) requires consideration of resistance factors based on the specific design equations applied to each limit state and the geomaterial type.

### **13.3 STEP-BY-STEP PROCEDURE: DESIGN FOR AXIAL LOAD**

A step-by-step design procedure is presented in LRFD format for design of drilled shafts under axial loading. The process is depicted in a simplified flow-chart in Figure 13-2. As noted above, this procedure is an expanded description of Block 11 of the overall design process of Figure 11-1; therefore each step is labeled as a sub-step of Block 11. The design steps are summarized as follows:

11-1. At each foundation location, divide the subsurface into a finite number of geomaterial layers; assign one of the following geomaterial types to each layer:

- Cohesionless soil
- Cohesive soil
- Rock
- Cohesive Intermediate Geomaterial

11-2. Review the strength and service limit states to be satisfied and the corresponding axial load combinations and load factors for each foundation. As discussed in the previous section, this step also corresponds to Block 3 in Figure 11-1.

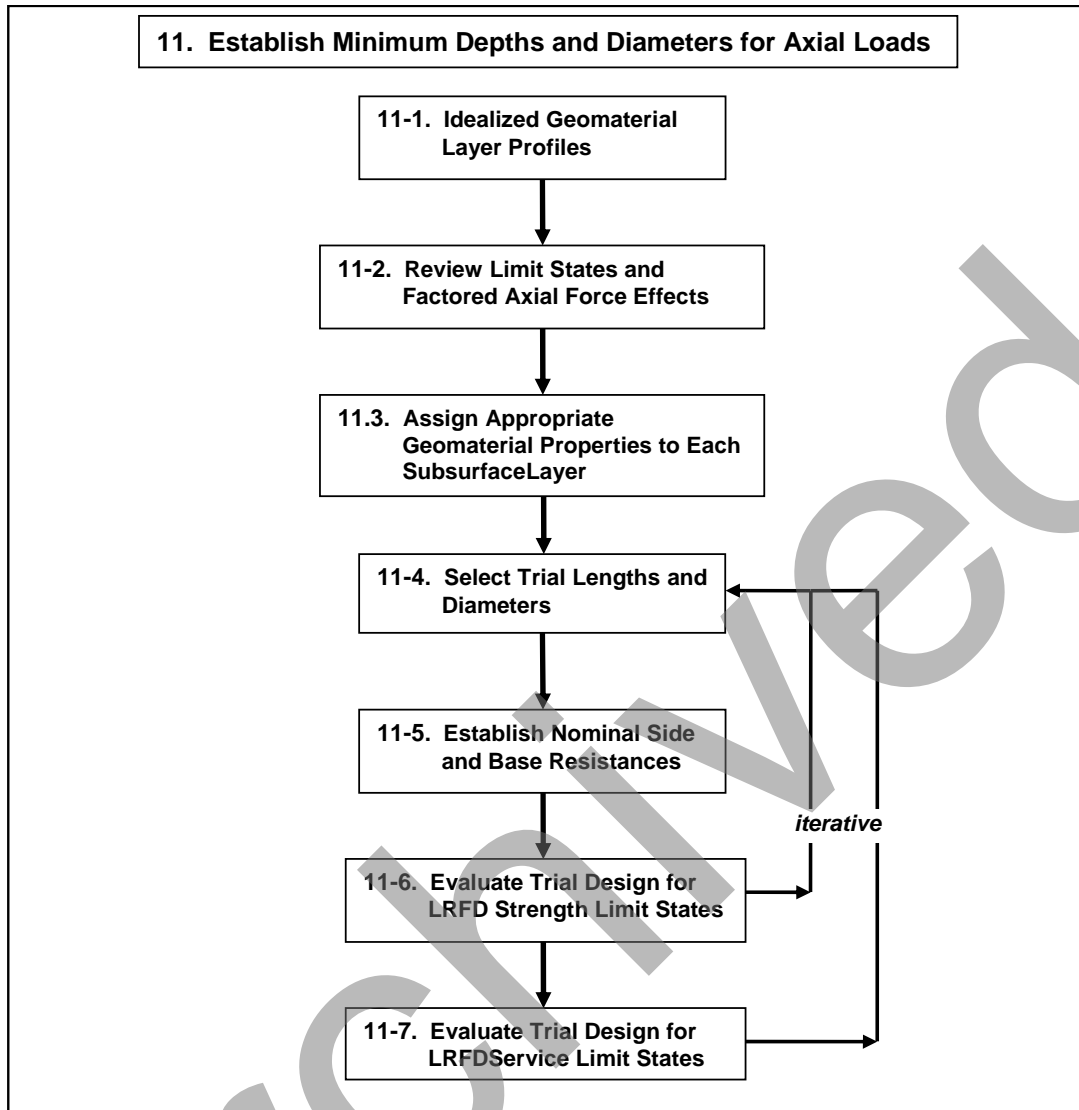


Figure 13-2 Flow Chart, Recommended Procedure for Axial Load Design

- 11-3. For each geomaterial layer established in Step 11-1 and for each limit state identified in Step 11-2, assign the appropriate geomaterial properties needed for evaluation of axial resistances. Identify the loading mode(s) to be analyzed for each geomaterial layer, *i.e.*, fully-drained or undrained.
- 11-4. For each drilled shaft, select trial lengths and diameters for initial analyses. As noted in Chapter 12, shaft diameter may be governed by lateral load considerations.
- 11-5. Compute values of nominal unit side resistance for all geomaterial layers through which the trial shaft extends and the nominal unit base resistance at the trial tip elevation.
- 11-6. Select appropriate resistance factors. Iterating from Step 11-4 as necessary, adjust the trial design to satisfy the following LRFD requirement for each strength limit state:

$$\sum \eta_i \gamma_i F_i \leq \sum \phi_i R_i$$

13-1

where the parameters in Equation 13-1 are defined in Section 10.2. Equation 13-1 can be stated as: the summation of factored axial loads may not exceed the summation of factored axial resistances.

- 11-7. Conduct load-deformation analysis for each trial design and iterate from Step 11-4 as necessary to satisfy the LRFD requirement for each service limit state. Service limit state evaluation for axial loading requires analysis of side and bases resistances that are mobilized at axial displacement corresponding to the tolerable deformation established for the structure being designed.

Results of the above procedure are combined with results of design for other applicable loading modes (lateral, extreme events, structural), and incorporated into the overall design procedure presented in Chapter 11. Details of each step are presented in the following sections.

### 13.3.1 Idealized Geomaterial Layer Profiles (Step 11-1)

A design zone is defined as an area at which one or more drilled shaft foundations will be installed and for which an idealized geomaterial layer profile will be developed. In the case of a bridge, a design zone might be defined by the location of a single pier to be supported on one or more drilled shafts. If a boring is made at each drilled shaft location, then each shaft may be assigned its own design zone. For each design zone an idealized profile is developed, as illustrated in Figure 13-3. Each layer within the zone is assigned a layer number  $i$ , thickness ( $\Delta z_i$ ), and geomaterial type. Criteria for assigning material types are as follows:

- (a) Cohesionless soil: materials classified as GW, GP, GM, SW, SP, SM, and ML. This includes all gravels and sands with less than 5 percent fines; gravels and sands with silty fines; and non-plastic silts.
- (b) Cohesive soil: materials classified as GC, SC, CL, CH, and MH with undrained shear strength of 5,000 psf (2.5 tsf) or less. These are clayey sands and gravels; lean and fat clay soils; and silts with liquid limit over 50.
- (c) Rock: cohesive, cemented geomaterial identified as rock on the basis of geologic origin.
- (d) Cohesive Intermediate Geomaterial (IGM): The term intermediate geomaterial (IGM) was first applied by O'Neill et al. (1996) in order to distinguish earth materials with strength properties that are intermediate between those of soil and rock. IGMs are defined on the basis of strength and are further categorized on the basis of whether the material is cohesionless or cohesive. Cohesionless IGMs are defined by O'Neill et al. as very dense granular geomaterials with SPT  $N_{60}$  values between 50 and 100. In this manual, cohesionless IGMs are grouped under "cohesionless soils". Cohesive IGMs are defined as materials that exhibit unconfined compressive strengths in the range of  $10 \text{ ksf} \leq q_u \leq 100 \text{ ksf}$ . Specific materials identified by O'Neill et al. as being cohesive IGMs include (1) argillaceous geomaterials such as heavily overconsolidated clays, clay shales, saprolites, and mudstones that are prone to smearing when drilled, and (2) calcareous rocks such as limestone and limerock and argillaceous geomaterials that are not prone to smearing when drilled. The term IGM was subsequently adopted in O'Neill and Reese (1999) and is used in the AASHTO (2007) LRFD specifications. Specific design equations are given herein for side and base resistances in cohesive IGMs.

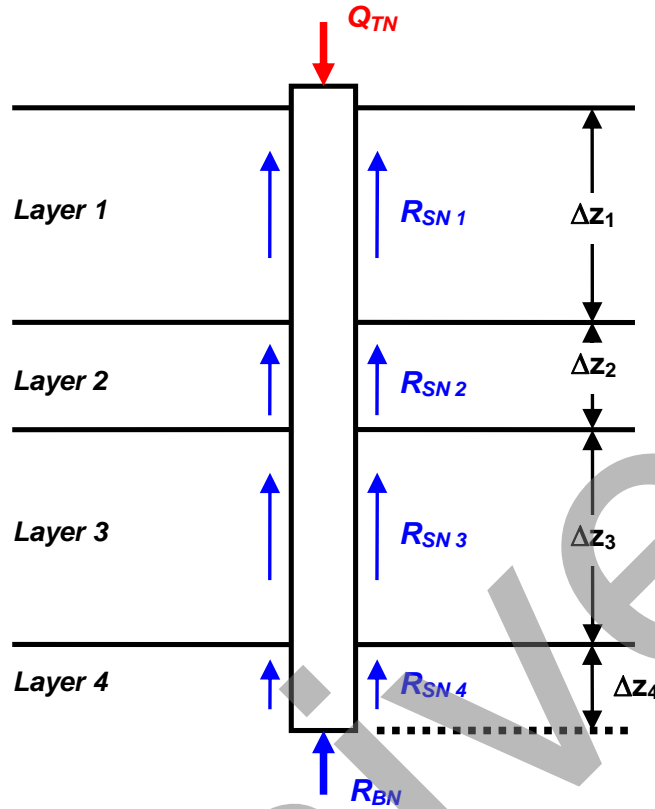


Figure 13-3 Idealized Geomaterial Layering for Computation of Compression Resistances

Some USCS classification groups are difficult to categorize as being cohesionless or cohesive for design purposes. Examples include dual classified groups such as SM-SC, ML-CL, and others. For these materials it may be necessary to measure the strength properties in laboratory direct shear or triaxial tests to determine whether the drained or undrained loading condition will govern its strength and, by inference, whether resistances of drilled shafts in those soil layers should be analyzed for drained or undrained loading. In addition, the wide range of geomaterials and geologic environments encountered in practice means there will always be materials that do not fit the models developed for routine foundation design. Strategies for dealing with some of these special or regionally important geomaterials are presented in Appendix B. Load testing and development of locally-calibrated resistance factors are recommended approaches for dealing with unusual or ‘non-textbook’ geomaterials.

Scour must be taken into account when developing idealized subsurface profiles. Section 10.3 notes that all drilled shaft resistances considered for strength and service limit states are to be evaluated under scour conditions corresponding to the *design* flood. Effects of scour that must be taken into account for drilled shaft design include: (1) changes in subsurface stress, (2) reduced embedment and therefore changes in axial and lateral resistances, and (3) possible changes in the structure response and the resulting foundation force effects (loading). Section 13.5 presents an overview of the basic definitions and concepts for evaluating scour. These concepts are applicable to the design of drilled shafts under both lateral and axial loading, and for evaluating scour under the *check* flood, which is treated as an extreme event and covered in Chapter 15. The design flood corresponds to a 100-year flood, or a smaller flood if it will cause scour depths deeper than the 100-year flood, while the check flood corresponds to a 500-year flood. Section 13.5.5 describes methods for evaluating effects of scour on axial resistances.



At this stage in the design process, it is recommended that a spreadsheet be established in which the first column identifies each geomaterial layer by number, and the second and third columns denote layer thicknesses and geomaterial types. In subsequent steps of the design, engineering properties can be added to the spreadsheet for each layer. Side and base resistances can be calculated or entered, and total resistances can be determined for trial designs.

### 13.3.2 Review Limit States and Factored Axial Loads (Step 11-2)

Block 3 of the overall design process is entitled “Determine Substructure Loads and Load Combinations at Foundation Level”. For axial loading, this step involves reviewing the limit states, load combinations and load factors, and scour conditions that pertain specifically to axial loading, as discussed in Section 13.2 of this chapter and in Chapter 10. This step requires direct communication between the structural engineer and foundation designer.

### 13.3.3 Geomaterial Properties and Loading Response Mode (Step 11-3)

For each strength limit state established in Step 11-2, the designer establishes whether the limit state will be evaluated for undrained loading, fully drained loading, or both. For each geomaterial layer, the designer then assigns the material properties needed to evaluate side resistances. Table 13-1 summarizes the geomaterial properties needed to evaluate drained and undrained resistances using the primary methods presented in Section 13.3.5 (Step 11-5).

**TABLE 13-1 GEOMATERIAL PROPERTIES REQUIRED FOR DRAINED AND UNDRAINED AXIAL RESISTANCES**

Geomaterial	Short-term resistance	Long-term (fully drained) resistance
Cohesionless soils (including materials classified previously as cohesionless IGM)	SPT N-values, $N_{60}$ and $(N_1)_{60}$ Average vertical effective stress ( $\sigma'_v$ ) for each layer Effective stress friction angle, $\phi'$	
Cohesive soils	Undrained shear strength, $s_u$	<sup>(1)</sup> Effective stress cohesion and friction angle, $c'$ and $\phi'$
Rock	Uniaxial compressive strength, $q_u$ RQD Geological Strength Index, GSI	
Cohesive IGM	Uniaxial compressive strength, $q_u$ RQD	<sup>(1)</sup> Effective stress cohesion and friction angle, $c'$ and $\phi'$

<sup>(1)</sup> Axial resistance of drilled shafts in cohesive soils or IGM for long-term fully-drained loading is not considered in AASHTO (2007) LRFD Specifications under the assumption that design for undrained loading is adequate for routine practice.

Side and base resistances of drilled shafts in cohesionless soils are evaluated under the assumption of fully drained response, with no need to distinguish between short-term and long-term conditions. Resistances provided by cohesive soil layers are evaluated under the assumption of undrained response to

short-term loading (end of construction) and fully drained response to long-term loading. Under most conditions encountered in practice, resistances provided by cohesive soils are evaluated under the assumption that the short-term, undrained resistance is critical, *i.e.*, less than the long-term, fully drained resistance. In these cases, resistances are evaluated in terms of the soil undrained shear strength,  $s_u$ . However, there are cases where a designer may wish to consider drained conditions. If a substantial portion of the shaft penetrates very heavily overconsolidated clay ( $OCR > 8$ ), where negative porewater pressures can develop in response to short-term loading, there could be good reason to consider designs for both drained and undrained conditions. The analysis resulting in the smaller value of resistance will govern the drilled shaft design.

It is common for a single drilled shaft to derive its resistance to axial loads from several different types of geomaterials, for example when the subsurface profile consists of multiple layers of both cohesive and cohesionless soils. The short-term resistance of the foundation is evaluated in terms of effective stress for cohesionless soil layers (same as long-term) but in terms of total stress for cohesive soil layers. As noted in the previous paragraph, it is assumed in most cases that the short-term, undrained resistance is critical for cohesive soil layers, and analysis is limited to this case. If the long-term, fully-drained response of the shaft is deemed critical, resistances of all geomaterial layers are evaluated in terms of effective stress.

Application of LRFD methodology is based on the use of mean values of engineering properties for each geomaterial layer providing axial resistance. When the parameters used to evaluate resistance (*e.g.*,  $N_{60}$ ,  $s_u$ ,  $q_u$ ) are presented in a spreadsheet format, computation of mean values, standard deviation, and coefficient of variation (COV%) is convenient and efficient. It is also useful to construct graphs showing the variation of each geomaterial property as a function of depth and to plot a linear trend line. The value at layer mid-depth (mean value) is the value selected for design. The COV must also be less than a specified value in order to apply the resistance factors presented in Table 10-5. A recommended upper limit on the COV of N-values within a single geomaterial layer is 45 percent. An upper limit on undrained shear strength of a cohesive soil layer (based on CU or UU triaxial tests) is 35 percent. Otherwise, additional data are required to reduce the variability associated with the geomaterial properties (reduce the COV) or the resistance factors must be reduced based on engineering judgment.

### 13.3.4 Trial Designs (Step 11-4)

This step involves selection of trial depths and diameters of drilled shafts to be evaluated for axial force effects associated with each limit state established in Step 11-2. If trial designs have been established on the basis of lateral loading (Chapter 12) these trial dimensions provide a starting point. Experience in drilled shaft design and thorough knowledge of the ground conditions are needed to make reasonable approximations for initial trial designs. Several rules of thumb and general principles for selecting initial shaft geometries include the following:

- Length to diameter ratios (L/B) are generally in the range of 3 to 30
- In soil, depths to 100 ft and diameters up to 8 ft are considered routine (for construction) in most cases
- Depths to 200 ft and diameters up to 12 ft are within the range of well-equipped specialty subcontractors
- Rock sockets up to 50 ft are possible (but not usually warranted); common diameter of sockets  $B \leq 5$  ft
- Rock sockets up to 8 ft in diameter are within range of well-equipped, experienced specialty subcontractors

- Deeper and larger diameter shafts are always possible, but may be at premium costs and may pose major construction challenges
- If depth can be limited to allow the dry method of construction, costs and inspection effort are generally more favorable
- Where boulders or rock fragments are present, a larger diameter may be more favorable for material removal
- Structural considerations may govern shaft dimensions when it is desirable to match the diameter of the shaft and the structural column (typically the shaft diameter is slightly larger than the column to allow for drilled shaft installation tolerance); reinforcement may be continuous between the shaft and column or it may be spliced; close consultation with the project structural engineer is required to address these issues
- Shaft diameter should provide adequate concrete cover for the steel reinforcing bars. Minimum cover ranges from 3 to 6 inches, depending on shaft diameter, as described in Chapter 8 and in accordance with project specifications (Chapter 18).
- Shaft diameters in soil overburden should be 6 inches larger than the required diameter of the rock socket to facilitate operation of rock drilling equipment
- For sign structures, the shaft diameter should be large enough to accommodate the bearing plate.

Sites underlain by rock often present a variety of design choices that can significantly affect cost and constructability. If rock exists within the practical depth of excavation, a decision must be made whether to place the base of the shaft on top of the rock surface, into the rock (a socket), or to "float" the drilled shaft above the rock formation. Where adequate resistance can be developed to satisfy all of the relevant limit states and where scour is not an issue, the most economical design usually is one that avoids excavation of rock by either floating the shaft or locating the tip at top of rock. An exception would be the case in which the drilled shaft would not develop adequate resistance even with a very large diameter (say, up to 12 ft) and rock is relatively close to the ground surface.

The decision of whether to bear on rock or socket into rock is based on (i) quality of the rock near its interface with the overburden material, (ii) whether the rock is sloping severely, and (iii) whether adequate resistance can be developed without a socket. If the rock is highly weathered, karstic, or sloping severely, or if the overburden can be scoured down close to the rock surface, a socket is usually used. Otherwise, restricting excavation into the rock can result in cost savings relative to using a socket. If the rock is massive and hard (for example,  $q_u \geq 5,000$  psi), socket excavation will proceed slowly and construction costs will be high. In such a case it may be reasonable to specify a drilled shaft of relatively large diameter and position its base on the surface of the rock, or perhaps 6 to 12 inches into the rock to allow for making a seal with a casing, rather than designing for a smaller-diameter socket.

A designer must often decide whether to utilize a single large-diameter shaft or divide the load among two or more shafts in a group. In general, the single shaft option is more cost effective but there are exceptions. For example, if access is difficult such as on a steep slope, equipment for installing smaller diameter shafts in a group may be more feasible and cost-effective than use of large equipment that may require construction of temporary retaining walls or other slope stabilization measures. In rock, multiple, small-diameter sockets may be more constructible and cost-effective than a single large-diameter socket. In some cases the only way to establish the most cost-effective design is to consider both single-shaft options and trial designs involving multiple shafts. These options can then be compared on the basis of cost and constructability. Further issues associated with groups of drilled shafts are discussed in Chapter 14.

### 13.3.5 Calculate Nominal Side and Base Resistances (Step 11-5)

This step involves calculation of the geotechnical resistances for axial compression loads. The methods presented herein were selected to be consistent with those presented in Article 10.8 of the 2007 AASHTO LRFD Bridge Design Specifications, unless research shows that improved methods supported by data from full-scale axial load testing warrants an updated approach.

Considering the two components of resistance for axial compression loading (side and base), the summation of factored resistances (right side of Equation 13-1) for evaluation of LRFD strength limit states is given by:

$$\sum \phi_i R_i = \sum_{i=1}^n \phi_{S,i} R_{SN,i} + \phi_B R_{BN} \quad 13-2$$

where:

$R_{SN,i}$  = nominal side resistance for layer  $i$ ,  
 $\phi_{S,i}$  = resistance factor for side resistance in layer  $i$ ,  
 $n$  = number of layers providing side resistance,  
 $R_{BN}$  = nominal base resistance, and  
 $\phi_B$  = resistance factor for base resistance.

Nominal side resistance for a specific geomaterial layer is the product of the nominal unit side resistance ( $f_{SN}$ ) and the cylindrical surface area over which side resistance develops, expressed as the product of the layer thickness ( $\Delta z_i$ ) and the shaft circumference, or:

$$R_{SN} = \pi B \Delta z_i f_{SN} \quad 13-3$$

where:

$B$  = shaft diameter,  
 $\Delta z_i$  = thickness of layer  $i$ , and  
 $f_{SN}$  = nominal unit side resistance.

Nominal unit side resistance is evaluated in terms of effective stress for cohesionless soil layers. Nominal unit side resistance in cohesive soil layers and cohesive IGMs is evaluated in terms of total stress for end-of-construction (undrained) conditions. If the long-term (fully-drained) side resistance in cohesive soil is deemed to be important, effective stress analysis should be conducted. Nominal unit side resistance in rock is evaluated in terms of uniaxial compressive strength.

Nominal base resistance is the product of the nominal unit base resistance ( $q_{BN}$ ) and the cross-sectional area of bearing at the shaft base ( $A_{base}$ ), or:

$$R_{BN} = \frac{\pi B^2}{4} q_{BN} \quad 13-4$$

Methods for evaluating unit side and base resistances are presented for each category of geomaterial.

### 13.3.5.1 Cohesionless Soils

#### Side Resistance

The nominal side resistance of a drilled shaft in cohesionless soil can be expressed as the frictional resistance that develops over a cylindrical shear surface defined by the soil-shaft interface. As illustrated in Figure 13-4, the unit side resistance is directly proportional to the normal stress acting on the interface. By Equation 13-3, nominal side resistance is then given by:

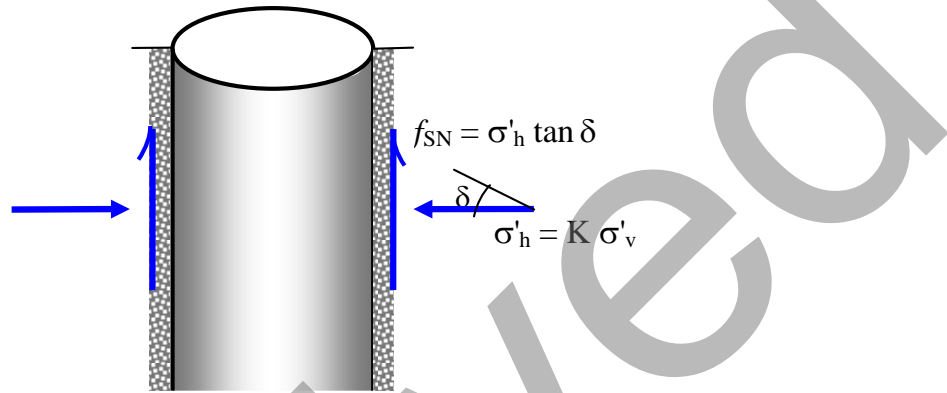


Figure 13-4 Frictional Model of Unit Side Resistance, Drilled Shaft in Cohesionless Soil

$$R_{SN} = \pi B \Delta z f_{SN} = \pi B \Delta z (\sigma'_v K \tan \delta) \quad 13-5$$

where:

$R_{SN}$  = nominal side resistance

$B$  = shaft diameter

$\Delta z$  = thickness of the soil layer over which resistance is calculated

$\sigma'_v$  = average vertical effective stress over the depth interval  $\Delta z$

$K$  = coefficient of horizontal soil stress ( $K = \sigma'_h / \sigma'_v$ )

$\sigma'_h$  = horizontal effective stress

$\delta$  = effective stress angle of friction for the soil-shaft interface

For convenience, the following terms may be combined:

$$\beta = K \tan \delta \quad 13-6$$

and

$$f_{SN} = \sigma'_v \beta \quad 13-7$$

in which  $\beta$  = side resistance coefficient (hence the term “beta method”) and  $f_{SN}$  = nominal unit side resistance. Several design models have been proposed for evaluating the  $\beta$  term in Equation 13-7. The approach currently recommended in AASHTO (2007) is the “O’Neill and Reese (1999)” method, in

reference to equations presented in the previous version of this manual. In this approach,  $\beta$  is calculated solely as a function of depth below the ground surface, without explicit consideration of soil strength or the in-situ state of stress. This approach is based on fitting a design curve to values of  $\beta$  back-calculated from field load tests. A more rational approach, as presented for example by Chen and Kulhawy (2002), is to evaluate separately values of  $K$  and  $\delta$  which are then combined to determine  $\beta$ . Results of research published over the past 15 years demonstrate that this approach can provide reliable estimates of side resistance and represents a rational method to incorporate soil strength and state of stress into design equations. It is recommended that designers employ this model, which is presented below. Additional commentary, including a comparison between the Reese and O'Neill method and the procedure presented herein, is given in Appendix C. It is noted further that this approach is applicable to all cohesionless soils, including those identified previously as cohesionless intermediate geomaterials.

The operative value of  $K$ , coefficient of horizontal soil stress, is a function of the in-situ (at-rest) value,  $K_o$ , and changes in horizontal stress that occur in response to drilled shaft construction, given by the ratio  $K/K_o$ . A rational first-order approximation is that  $K/K_o = 1$ , assuming there is no stress change induced by construction. For simple virgin loading-unloading of "normal soils" that are not cemented, the  $K_o$  value increases with overconsolidation ratio (OCR) and can be approximated according to (Mayne and Kulhawy, 1982):

$$K_o = (1 - \sin \phi') \text{OCR}^{\sin \phi'} \leq K_p \quad 13-8$$

$$\text{OCR} = \frac{\sigma'_p}{\sigma'_v} \quad 13-9$$

where  $\sigma'_p$  = effective vertical preconsolidation stress. Note that the value of  $K_o$  as given by Equation 13-8 is limited to an upper-bound value corresponding to the coefficient of passive earth pressure, which, for a cohesionless soil, is given by:

$$K_p = \tan^2 \left( 45^\circ + \frac{\phi'}{2} \right) \quad 13-10$$

A variety of methods have been proposed for evaluation of either  $K_o$  or  $\sigma'_p$  by correlations with in-situ test results. For a practical estimate based on the most commonly used in-situ test (SPT) the following correlation is suggested by Mayne (2007):

$$\frac{\sigma'_p}{p_a} \approx 0.47 (N_{60})^m \quad 13-11$$

where  $m = 0.6$  for clean quartzitic sands and  $m = 0.8$  for silty sands to sandy silts (*e.g.*, Piedmont residual soils), and  $p_a$  = atmospheric pressure in the same units as  $\sigma'_p$  (for example, 2,116 psf). Kulhawy and Chen (2007) suggest the following correlation provides a good fit for gravelly soils:

$$\frac{\sigma'_p}{p_a} = 0.15 N_{60} \quad 13-12$$

Substituting Equations 13-9 through 13-12 into Equation 13-6 leads to the following approximation of  $\beta$  for cohesionless soils:

$$\beta \approx (1 - \sin \phi') \left( \frac{\sigma'_p}{\sigma'_v} \right)^{\sin \phi'} \tan \phi' \leq K_p \tan \phi' \quad 13-13$$

where  $\sigma'_p$  is estimated by Equation 13-11 for sandy soils and Equation 13-12 for gravelly soils. The value of  $\beta$  at shallow depths should be limited to the value corresponding to a depth of 7.5 ft, which corresponds to a vertical effective stress of approximately 900 psf. At lower confining stress, the correlations for effective stress friction angle and preconsolidation stress have not been validated and it would be prudent to limit  $\beta$  to the values corresponding to this depth. The value of  $\beta$  evaluated by Equation 13-13 is substituted into Equation 13-7 for determination of unit side resistance and this value is substituted into Equation 13-5 for determination of nominal side resistance  $R_{SN}$  for each layer of cohesionless soil. This model accounts for site-specific variations in horizontal stress and soil strength in a rational manner. The approach is also adaptable to other in-situ methods that allow measurement of horizontal soil stress and its variation with depth, such as pressuremeter test (PMT) and flat plate dilatometer test (DMT). The principal limitation of this approach relates to its reliance on N-values and the correlations employed between N-values, friction angle, and preconsolidation stress. Furthermore, resistance factors have not been established for this method through a probability-based calibration study with AASHTO LRFD load factors. Calibration to allowable stress design (ASD) using a factor of safety of  $FS = 2.5$  yields a resistance factor for side resistance in cohesionless soils of  $\phi_S = 0.55$  as discussed in Chapter 10. Until the proper reliability-based calibration study is conducted, this value is recommended. Agencies are also encouraged to establish resistance factors based on local calibrations.

In the approach described above, it is assumed that no change in horizontal stress, and therefore no change in  $K$ , occurs as a result of construction. Experience demonstrates this assumption is valid for dry, slurry (wet-hole), and casing methods of construction with minimal sidewall disturbance, proper handling of slurry and casing, and prompt placement of concrete (Chen and Kulhawy, 2002). However, when these aspects of construction quality are not controlled properly, the coefficient  $K$  can be reduced to 2/3 of its initial in-situ value ( $K_0$ ), or lower in extreme cases of soil caving. Judgment and accurate knowledge of field realities are therefore needed to assess the applicability of the design equations to individual projects. The recommended approach is to take the necessary measures that will assure quality of construction, thereby justifying the use of the design equations presented above.

When permanent casing is used and extends through layers of cohesionless soil, the basic concepts presented above are valid, with proper consideration of differences in the interface shear strength. AASHTO (2007) states that no specific data are available, but that casing reduction factors of 0.60 to 0.75 are commonly used. A common practice is to specify permanent casing in subsurface zones where scour is expected, in which case side resistance may be neglected over this depth.

For each strength or service limit state considered, side resistance in cohesionless soils must account for scour resulting from the design flood. The most significant effect is that all material above the total scour line is assumed to be removed and unavailable for axial support. Changes in subsurface stress also occur in response to removal of soil, and these changes will affect side resistance calculated by the  $\beta$ -method. This issue is considered in Section 13.5.

Illustrative Example 13-1 on the following page demonstrates evaluation of unit side resistance by the  $\beta$ -method as presented above.

---

### Illustrative Example 13-1: Side Resistance in Cohesionless Soil Layer by $\beta$ -Method

For the subsurface profile shown in Figure 13-5, calculate the nominal unit side resistance for the layer of fine sand between depths  $z$  of 33 ft and 40 ft, using the  $\beta$ -method. The total unit weight of the soil is estimated to be 120 pcf.

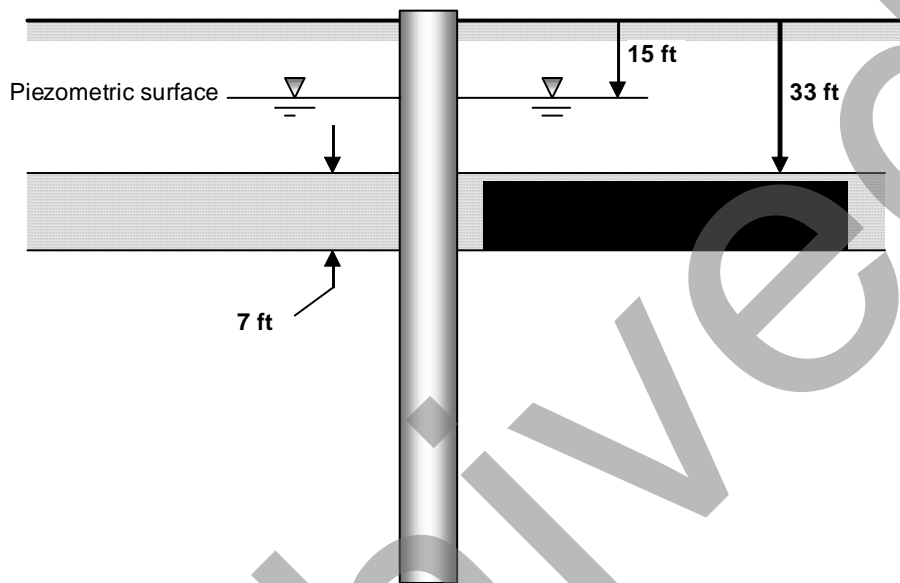


Figure 13-5 Subsurface Profile and Drilled Shaft for Illustrative Example 13-1

Because the geomaterial layer is “cohesionless soil” we are evaluating the fully-drained side resistance in terms of effective stress. At the center of the fine sand layer ( $z = 36.5$  ft):

$$\sigma'_v = 36.5(120) - (36.5-15)62.4 = 3,038 \text{ psf}$$

$$\phi' = \delta = 27.5 + 9.2 \log[23] = 40^\circ \quad \text{Eq. 3-8}$$

$$\sigma'_p \approx 2,116 \times 0.47 (27)^{0.6} = 7,185 \text{ psf} \quad \text{Eq. 13-11}$$

$$OCR = \frac{7,185}{3,038} = 2.37 \quad \text{Eq. 13-9}$$

$$K_o = (1 - \sin 40^\circ) 2.37^{\sin 40^\circ} = 0.62 \leq K_p (= 4.60) \quad \text{Eq. 13-8}$$

$$\beta = K \tan \delta = 0.62 \tan (40^\circ) = 0.52 \quad \text{Eq. 13-6}$$

$$\text{Unit side resistance: } f_{SN} = \sigma'_v \beta = 3,038 \text{ psf} (0.52) = \underline{\underline{1,580 \text{ psf}}} \quad \text{Eq. 13-7}$$


---



### Base Resistance

Base resistance in cohesionless soils develops as a function of downward displacement (Figure 13-1b). Observations from load tests show that the downward displacement required to mobilize the full base resistance varies widely. This behavior can be attributed to the influence of drilled shaft construction on soil properties and stresses beneath the base. The process of excavation releases some of the stress in the soil beneath the base. The magnitude of stress release increases with increasing depth and may allow heave, lateral flow, and possibly upward groundwater seepage, all of which will decrease soil strength and stiffness from the initial in-situ state. The level of cleanout may also affect base load-deformation behavior, particularly if loose excavated soils (cuttings) are present at the base. Bearing capacity theory for cohesionless soils provides an analytical solution for the maximum unit bearing stress that can be developed. However, when changes in soil properties as a result of stress release and cleanout are considered, theoretical evaluation of bearing capacity becomes less reliable. Therefore, direct empirical correlations between SPT N-values and mobilized base resistance determined from load tests provide a more pragmatic approach. The following correlation developed by Reese and O'Neill (1989) is recommended for routine design:

$$q_{BN} \text{ (tsf)} = 0.60 N_{60} \leq 30 \text{ tsf} \quad 13-14$$

in which  $q_{BN}$  = nominal unit base resistance and  $N_{60}$  is the average value between the base and two diameters beneath the base. Equation 13-14 is based on measured base resistances from compression load tests on drilled shafts with clean bases at settlements equal to five percent of the base diameter. The upper limit of 30 tsf corresponds to the largest values observed in the load tests used to develop the correlation. Note that the N-value to be used in Equation 13-14 is the field value, with no correction for overburden stress, although it is recommended that N-values correspond to 60 percent hammer efficiency. Equation 13-14 is also limited to cohesionless soils with SPT N-values of 50 blows per foot or less. In cohesionless soils with N-values exceeding 50, load testing is recommended; otherwise unit base resistance is limited to the upper-bound value indicated in Equation 13-14. Agencies are also encouraged to develop in-house correlations and to conduct calibration studies to establish resistance factors appropriate for local conditions and construction practices.

An important point is noted regarding the use of Equation 13-14 to define a strength limit state. Since the equation predicts the base resistance developed at a defined value of displacement, it could be argued that Equation 13-14 does not define a limit based on strength, but rather on displacement. Nevertheless, the calibration studies conducted by Barker et al. (1991), Paikowsky et al. (2004), and Allen (2005) are based on Equation 13-14. According to Allen (2005) the current resistance factor of  $\phi = 0.50$  specified in AASHTO (2007) was established on the basis of fitting to a factor of safety  $FS = 2.75$  with consideration of the reliability-based factors reported by Paikowsky et al. (2004).

As an alternative to the empirical relationship given by Equation 13-14, bearing capacity theory can be applied to the calculation of nominal base resistance of a drilled shaft bearing in cohesionless soil. The bearing capacity equation and its application to drilled shafts are presented in Appendix C. For the case of bearing in cohesionless soils, the deformation required for mobilization of the full base resistance can vary over a wide range as noted above. For this reason, values based on the simple expression of Equation 13-14 are recommended for routine design. The bearing capacity equations given in Appendix C are presented for informational purposes and for designers wishing to conduct sensitivity analyses or more in-depth studies of base resistance for a specific project.

As described in Sections 4.5 and 9.5 of this manual, the application of grout under pressure, applied at the base of the shaft after concrete has cured, is sometimes used to improve the base resistance of drilled shafts in cohesionless soils. At the present time there is no generally accepted method for calculating

design values of base resistance for shafts when base grouting is applied. However, some researchers have proposed design equations based on load testing and designers may find this information to be useful. A procedure developed by Mullins et al. (2006) is presented in Appendix C (Section C.3). Agencies wishing to use base grouting should consider developing local calibrations for the specific base grouting methods to be used on their projects and for local conditions, using calibration procedures described in Chapter 10. Load testing for field verification and/or for the purpose of developing calibrated resistance factors is highly recommended. No equations or resistance factors that account for base grouting are given in current AASHTO specifications.

### 13.3.5.2 Cohesive Soils

#### *Side Resistance*

Short-term undrained side resistance in cohesive soil layers is evaluated in terms of undrained shear strength. Equation 13-3 then becomes:

$$R_{SN} = \pi B \Delta z f_{SN} = \pi B \Delta z (\alpha s_u)_i \quad 13-15$$

where:

$R_{SN}$  = nominal side resistance,  
 $B$  = shaft diameter,  
 $\Delta z$  = thickness of the soil layer over which resistance is calculated,  
 $s_u$  = average undrained shear strength over the depth interval  $\Delta z$ ,  
 $\alpha$  = coefficient relating unit side resistance to undrained shear strength (hence the term “alpha method”), and  
 $f_{SN}$  = nominal unit side resistance.

Key terms to evaluate in Equation 13-15 are the mean undrained shear strength of the cohesive soil layer and the coefficient  $\alpha$ .

Evaluation of  $\alpha$  is as follows:

$\alpha = 0$  between the ground surface and a depth of 5 ft or to the depth of seasonal moisture change, whichever is greater

$\alpha = 0.55$  along remaining portions of the shaft for  $\frac{s_u}{p_a} \leq 1.5$

$\alpha = 0.55 - 0.1 \left( \frac{s_u}{p_a} - 1.5 \right)$  along remaining portions of the shaft for  $1.5 \leq \frac{s_u}{p_a} \leq 2.5$

$p_a$  = atmospheric pressure in the same units as  $s_u$  (2,116 psf or 14.7 psi in U.S. customary units).

The resistance factor given in Table 10-5 for application to the side resistance calculated using the  $\alpha$ -method as presented above is  $\phi = 0.45$ . The basis of this recommendation (Allen, 2005) is a combination of fitting to the ASD factor of safety (FS = 2.5) and taking into account the reliability-based analysis conducted by Paikowsky et al. (2004).

The practice of neglecting side resistance over the top 5 ft or depth of seasonal moisture change accounts for the potential loss of side resistance as soil expands and contracts in response to wetting and drying,

freezing and thawing, “gapping” caused by cyclic lateral loading, or any process occurring near the ground surface having the potential to soften the soil or eliminate contact between the shaft and soil. This recommendation is subject to modification based on local experience and judgment of the designer.

The previous version of this manual (Reese and O’Neill, 1999) and AASHTO (2007) recommend neglecting side resistance over a distance of one diameter above the base of drilled shafts where this portion of the shaft derives its resistance from a cohesive soil. The recommendation is based on numerical modeling that predicts a zone of tension at the soil-shaft interface in the zone immediately above the base. However, this recommendation is not supported by field load test data and the authors of this version recommend that side resistance should not be neglected over the bottom one diameter.

Illustrative Example 13-2 on the following page demonstrates the calculation of nominal side resistance for a drilled shaft in cohesive soil by the  $\alpha$ -method.

When permanent casing is used and extends through layers of cohesive soil, side resistance will generally be reduced relative to that of an uncased shaft. Reduction factors applied to steel piles compared to driven concrete piles range from 50 to 75 percent and can be used to provide an approximate range of reduction in cased drilled shafts, although no specific data are available to support recommendations for reduction factors.

An implicit assumption associated with use of the  $\alpha$ -method as described above is that design of drilled shafts in cohesive soils for short-term undrained loading by total stress analysis is adequate for routine design. There is no evidence or record of unsatisfactory performance to suggest otherwise. However, a designer may choose to consider the fully-drained side resistance for drilled shafts in very heavily overconsolidated clay ( $OCR > 8$ ), based on the concept that the long-term strength of these soils is lower than the short-term undrained strength. In this case, effective stress analysis is conducted in the same manner as described above for cohesionless soils, using Equation 13-5. The parameters used in Equation 13-5 are evaluated differently. It is normally assumed that effective stress cohesion ( $c'$ ) is zero in response to the drilling process. Values of effective stress friction angle ( $\phi'$ ) should be measured in laboratory triaxial tests, either consolidated-drained (CD) or consolidated-undrained (CU) with porewater pressure measurements. The interface friction angle can be taken equal to  $\phi'$ . The value of  $K$  can be taken equal to  $K_0$  and evaluated by appropriate in-situ measurements or on the basis of overconsolidation ratio as described in Chapter 3 (see Equation 3-15). No recommendation is made herein or in AASHTO (2007) for the resistance factor to apply to the fully-drained side resistance in cohesive soils.

### *Base Resistance*

Bearing capacity theory applied to the case of a deep foundation bearing on a cohesive soil, in terms of total stress analysis, yields the following approximate expression which is sufficient for design (O’Neill and Reese, 1999):

$$q_{BN} = N_c^* s_u \quad 13-16$$

where  $N_c^*$  = bearing capacity factor and  $s_u$  = mean undrained shear strength of the cohesive soil over a depth of  $2B$  below the base. For cases where the shaft depth is at least 3 times the diameter and the mean undrained shear strength is at least 2,000 psf, the bearing capacity factor can be taken as 9.0. For smaller values of undrained shear strength,  $N_c^*$  can be approximated as a function of undrained shear strength as given in Table 13-2. Linear interpolation can be used for values between those tabulated. Note that it is unusual to locate the base of a drilled shaft in cohesive soil with  $s_u$  less than 2,000 psf when compression loads are supported.

### Illustrative Example 13-2: Side Resistance in Clay

A trial drilled shaft is 5 ft in diameter and will be founded in dense sand and gravel, as shown in Figure 13-6. The overburden soil is stiff clay. Laboratory CU triaxial tests on undisturbed samples of the clay were plotted versus depth and a trend line was fitted to the results. The trend line is represented by the values of undrained shear strength ( $s_u$ ) shown in the figure. Calculate the nominal side resistance for the portion of the shaft in the clay.

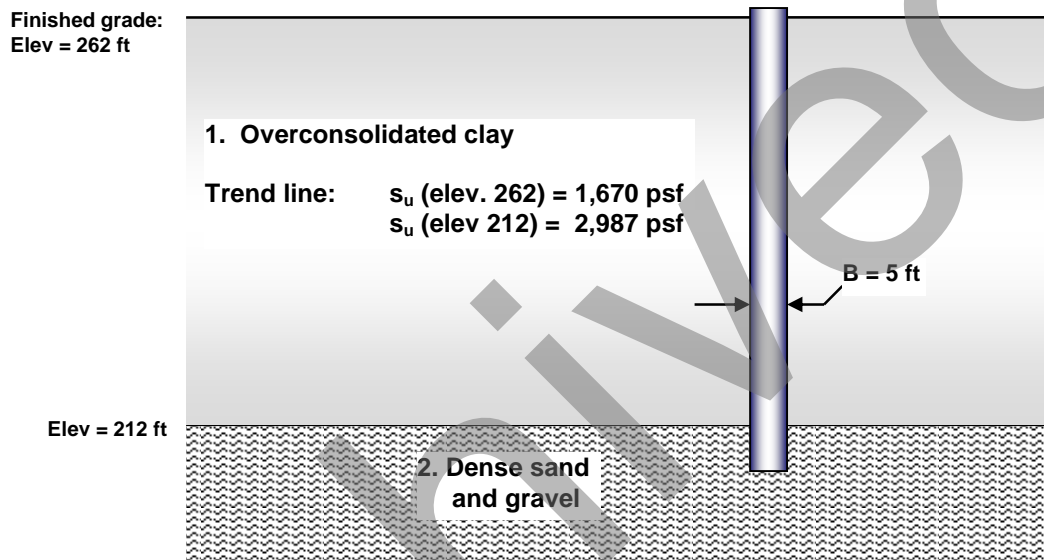


Figure 13-6 Soil Profile and Trial Shaft for Illustrative Example 13-2

The geomaterial layer is “cohesive soil” and the undrained side resistance is evaluated in terms of total stress. Layer thickness:  $\Delta z_1 = 262 - 212 = 50$  ft. For design, if the side resistance is neglected over a depth of 5 ft at the top of the shaft, the layer thickness is 45 ft and the average undrained shear strength is considered over this depth. At  $z = 5$  ft,  $s_u = 1,802$  psf and:

$$\text{Average } s_u = \frac{1,802 + 2,987}{2} = 2,395 \text{ psf} \quad s_u/p_a = 2,395 \text{ psf} / 2,116 \text{ psf} = 1.13 \leq 1.5$$

therefore:  $\alpha = 0.55$

Unit side resistance =  $0.55 (2,395 \text{ psf}) = 1,317 \text{ psf}$

Nominal side resistance, Layer 1:  $R_{SN,1} = \pi (5 \text{ ft}) (45 \text{ ft}) 1,317 \text{ psf} = 930,932 \text{ lb} = \mathbf{930.9 \text{ kips}}$

**TABLE 13-2 BEARING CAPACITY FACTOR  $N^*_c$**

Undrained shear strength, $s_u$ (lb/ft <sup>2</sup> )	$I_r \approx \frac{E_u}{3s_u}$	$N^*_c$
500	50	6.5
1,000	150	8.0
2,000	250 - 300	9.0

$E_u$  = Undrained Young's Modulus

For drilled shafts with depth of embedment less than three times the diameter ( $D < 3B$ ) the following expression applies:

$$q_{BN} = \frac{2}{3} \left[ 1 + \frac{1}{6} \left( \frac{D}{B} \right) \right] N^*_c s_u$$

13-17

where  $N^*_c$  is approximated from Table 13-2. Additional discussion on the application of bearing capacity theory to base resistance of drilled shafts in cohesive soils is given in Appendix C.

The resistance value of  $\phi = 0.40$  (Table 10-5) for base resistance by the above method is based on the report by Allen (2005) and was established by a combination of fitting to the ASD factor of safety (FS = 2.75) and taking into account the reliability-based analysis conducted by Paikowsky et al. (2004).

The practice of constructing belled shafts on transportation projects has become very rare. However, belled shafts could be considered in order to increase base resistance in cohesive soils by providing a larger tip bearing area. In the previous version of this manual O'Neill and Reese (1999) presented an empirical equation for establishing a reduced nominal base resistance for belled shafts in cohesive soils with bell diameters greater than 6 ft and base resistance determined by Equation 13-16 or 13-17. The relationship is presented in Appendix C. There is currently no basis for establishing a resistance factor for application to the reduced base resistance. If the use of belled shafts is under consideration, load testing is recommended for evaluation of base resistance.

A designer may wish to evaluate the fully-drained base resistance of drilled shafts in cohesive soils using effective stress analysis. As noted above for side resistance, fully-drained response may be considered for shafts bearing on heavily overconsolidated clay soils (OCR > 8). In this case base resistance can be analyzed in terms of bearing capacity theory as described in Appendix C. The analysis requires knowledge of the effective stress strength properties ( $c'$  and  $\phi'$ ) which should be measured by appropriate laboratory tests (CD or CU with pore water pressure measurements, triaxial compression). Effective stress analysis with bearing capacity theory is not addressed in current AASHTO (2007) specifications.

### 13.3.5.3 Rock

#### *Side Resistance*

Unit side resistance for shafts in rock may be evaluated on the basis of mean uniaxial compressive strength of the rock, as follows:

$$\frac{f_{SN}}{p_a} = C \sqrt{\frac{q_u}{p_a}} \quad 13-18$$

in which  $q_u$  = mean value of uniaxial compressive strength for the rock layer,  $p_a$  = atmospheric pressure in the same units as  $q_u$ , and  $C$  = a regression coefficient used to analyze load test results. Studies relating side resistance to rock compressive strength include those of Horvath and Kenney (1979), Rowe and Armitage (1987), Kulhawy and Phoon (1993), and others. The most recent regression analysis of available load test data is reported by Kulhawy et al. (2005) and demonstrates that the mean value of the coefficient  $C$  is approximately equal to 1.0. The authors recommend the use of Equation 13-20 with  $C = 1.0$  for design of “normal” rock sockets. A lower bound value of  $C = 0.63$  was shown to encompass 90% of the load test results. The authors note several important aspects of their analysis compared to earlier studies. First, only load test data exhibiting load-displacement curves to failure were used so that capacities were evaluated in a consistent manner. Failure is defined using the “L<sub>1</sub>-L<sub>2</sub>” method of load test interpretation described in Appendix C (see Figure C-4). Second, earlier correlation equations incorporated data from load tests on rock anchors. Analysis by Kulhawy et al. (2005) showed that these data constitute a separate population and should not be included with drilled shafts. Third, the authors emphasize the importance of using values of  $q_u$  determined from laboratory uniaxial compression tests in accordance with proper test procedures such as those given by ASTM and on specimens at field moisture contents. Estimating  $q_u$  from index tests such as the point load, Schmidt hammer, or others, may be inappropriate due to high levels of variability in correlations with  $q_u$ . Use of strength values from samples that have been allowed to dry from their field condition will lead to higher values of  $q_u$  and overestimation of foundation resistance. However, the value of  $q_u$  used in Equation 13-18 should not exceed the compressive strength of the drilled shaft concrete.

The term “normal” as used above applies to sockets constructed with conventional equipment and resulting in nominally clean sidewalls without resorting to special procedures or artificial roughening. Rocks that may be prone to smearing or rapid deterioration upon exposure to atmospheric conditions, water, or slurry, are outside the “normal” range and may require additional measures to insure reliable side resistance. Rocks exhibiting this type of behavior include clay shales and are discussed further as special geomaterials in Appendix B. Rock that cannot support construction of an unsupported socket without caving is also outside the “normal” and will likely exhibit lower side resistance than given by Equation 13-18 with  $C = 1.0$ .

The expression for unit side resistance in rock as given by O’Neill and Reese (1999), and adopted in the AASHTO (2007) LRFD specifications has the same form as Equation 13-18 but with a recommended value of the coefficient  $C = 0.65$ . This is referred to as the “Horvath and Kenney” method based on their 1979 paper. O’Neill and Reese (1999) also applied an empirical reduction factor  $\alpha_E$  to account for the degree of fracturing. The resulting expression is:

$$\frac{f_{SN}}{p_a} = 0.65 \alpha_E \sqrt{\frac{q_u}{p_a}} \quad 13-19$$

where the coefficient  $\alpha_E$  is determined as a function of the estimated ratio of rock mass modulus to modulus of intact rock ( $E_M/E_R$ ). This ratio is estimated from the RQD of the rock. The resulting relationship between RQD and  $\alpha_E$  is given in Table 13-3.

**TABLE 13-3 SIDE RESISTANCE REDUCTION FACTOR FOR ROCK**

RQD (%)	Joint Modification Factor, $\phi$	
	Closed joints	Open or gouge-filled joints
100	1.00	0.85
70	0.85	0.55
50	0.60	0.55
30	0.50	0.50
20	0.45	0.45

Considering the most recent research on side resistance in rock, in particular the work cited above by Kulhawy et al. (2005) that incorporates the original data of Horvath and Kenney (1979) plus additional data compiled over the ensuing 25+ years, Equation 13-18 with  $C = 1.0$  is recommended for routine design of rock sockets. For rock that cannot be drilled without some type of artificial support, such as casing or by grouting ahead of the excavation, the reduction factors given in Table 13-3 based on RQD are recommended for application to the resistance calculated by Equation 13-19. The resistance factor recommended with use of Equations 13-18 and 13-19 is  $\phi = 0.55$  based on fitting to ASD with a factor of safety  $FS = 2.5$ , as discussed in Chapter 10 and presented in Table 10-5.

Artificial roughening of rock sockets through the use of grooving tools or other measures can increase side resistance compared to normal sockets. Regression analysis of the available load test data by Kulhawy and Prakoso (2007) suggests a mean value of  $C = 1.9$  with use of Equation 13-18 for roughened sockets. It is strongly recommended that load tests or local experience be used to verify values of  $C$  greater than 1.0. However, the advantages of achieving higher resistance by sidewall roughening often justify the cost of load tests.

Advanced theoretical models of rock socket behavior that account for the mechanisms of shaft-rock interaction, such as adhesion, friction, dilatancy, roughness, and rock mass strength and stiffness, can be applied to socket design. For example, the computer program "ROCKET" developed through research by Seidel and co-workers (Seidel and Collingwood, 2001) models the complete load-displacement curve of rock sockets and accounts for the mechanisms of load transfer listed above. Additional rock mass properties are required as input, including rock mass modulus and socket roughness. For transportation agencies willing to invest in the required information and software, more advanced models can be a valuable design tool. However, for many foundation design cases, the only rock strength property available is the intact rock uniaxial compressive strength ( $q_u$ ), and therefore the foundation resistances typically are related empirically to  $q_u$  as presented above.

#### *Base Resistance*

Base resistance in rock is more complex than in soil because of the wide range of possible rock mass conditions. Various failure modes are possible depending upon whether rock mass strength is governed by intact rock, fractured rock mass, or structurally controlled by shearing along dominant discontinuity surfaces. In practice, it is common to have information on the uniaxial compressive strength of intact rock ( $q_u$ ) and the general condition of rock at the base of a shaft. Empirical relationships between nominal unit base resistance ( $q_{BN}$ ) and rock compressive strength can be expressed in the form:

$$q_{BN} = N_{cr}^* q_u \quad 13-20$$

where  $N_{cr}^*$  is an empirical bearing capacity factor for rock. Studies relating  $q_{BN}$  to  $q_u$  are reported by Zhang and Einstein (1998) and Prakoso and Kulhawy (2002). There is overlap in the data used in each study although the authors used different interpretations of load test results to establish  $q_{BN}$ . Prakoso and Kulhawy used a consistent definition of limiting base resistance, and limited the data to tests that exhibited failure according to the  $L_1$ - $L_2$  method as described in Appendix C (see Figure C-4). Results of the Prakoso and Kulhawy study are shown in Figure 13-7 in which the bearing capacity factor ( $N_{cr}^*$ ) is plotted against shaft diameter. The data base included 14 load tests at 9 sites in several rock types, mainly fine-grained sedimentary rocks. The mean value of  $N_{cr}^*$  is 3.38 with a coefficient of variation COV = 35.4%. A lower bound value of  $N_{cr}^* = 2.5$  incorporates most of the points shown in Figure 13-7 and is consistent with work by Rowe and Armitage (1987) in which a value of  $N_{cr}^* = 2.5$  is recommended for competent rock. When the data used by Zhang and Einstein are evaluated in the format of Equation Figure 13-20, they yield a mean value of  $N_{cr}^* = 3.56$  and a COV = 61.0%. Considering these three studies, a value of  $N_{cr}^* = 2.5$  is recommended for design when  $q_u$  is the sole parameter used for establishing  $q_{BN}$  and the following conditions are met:

1. The drilled shaft base is bearing on rock which is either massive or tightly jointed (no compressible seams or joints) to a depth of at least one diameter beneath the base,
2. It can be verified that no solution cavities or voids exist beneath the base, and
3. A clean base can be achieved and verified using conventional clean-out equipment.

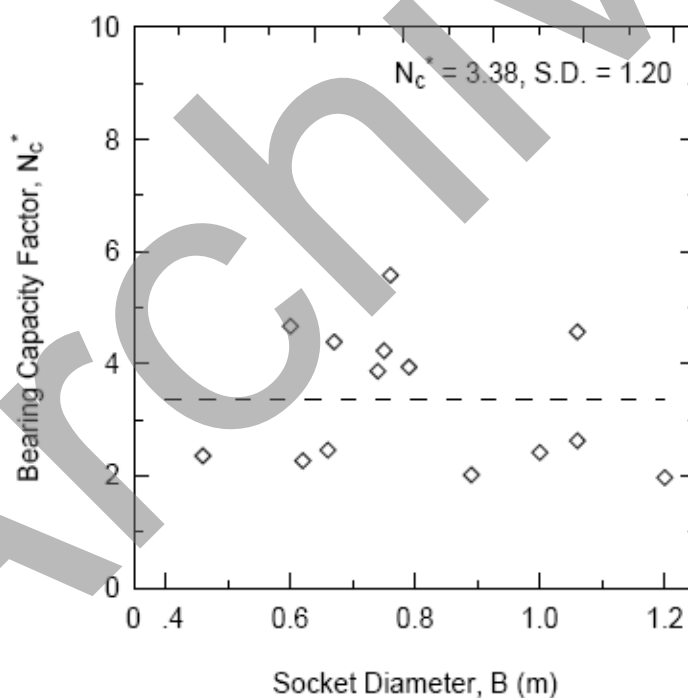


Figure 13-7 Base Resistance Factor for Rock (Prakoso and Kulhawy 2002)

Note that the use of Equation 13-20 with the recommended value of  $N_{cr}^* = 2.5$  is consistent with the previous version of this manual and is based on the original work by Rowe and Armitage (1987). The more recent research cited above validates the use of this equation for routine design in competent rock.



As discussed in Chapter 10, the LRFD resistance factor specified in AASHTO (2007) for use of Equation 13-20 with  $N_{cr}^* = 2.5$  is  $\phi = 0.55$ , based on fitting to an ASD factor of safety  $FS = 2.5$ . Values of  $N_{cr}^*$  greater than 2.5, which clearly are possible based on Figure 13-7, are justified when they can be verified by local experience or load testing.

When data are available on the spacing and condition of discontinuities in rock beneath the tip, the following method, which is covered by AASHTO (2007), can be applied. The method is described in the Canadian Foundation Engineering Manual (Canadian Geotechnical Society, 1995) and provides a more refined estimate of  $N_{cr}^*$  for shafts bearing on sedimentary rock with primarily horizontal discontinuities, where discontinuity spacing is at least 1 ft, and discontinuity aperture does not exceed 0.25 inch. The method is given by the following:

$$q_{BN} = 3q_u K_{sp} d \quad 13-21$$

in which:

$$K_{sp} = \frac{3 + \frac{s_v}{B}}{10 \sqrt{1 + 300 \frac{t_d}{s_v}}} \quad 13-22$$

$$d = 1 + 0.4 \frac{D_s}{B} \leq 3.4 \quad 13-23$$

where:

- $q_u$  = uniaxial compressive strength of the bearing rock,
- $s_v$  = vertical spacing between discontinuities;
- $t_d$  = aperture (thickness) of discontinuities;
- $B$  = socket diameter,
- $D_s$  = depth of socket (rock) embedment.

In this formulation, the quantity  $3K_{sp} d$  is equivalent to the base resistance factor  $N_{cr}^*$  of Equation 13-20. For the range of parameters over which this method is applicable, equivalent values of  $N_{cr}^*$  range approximately from 0.4 to 5.1. For rock that does not meet the criterion that vertical joint spacing is at least 1 ft, load testing is recommended to verify base resistance. The resistance factor recommended for this method is  $\phi = 0.50$  (see Table 10-5) and is based on fitting to ASD as reported by Barker et al. (1991).

Bearing capacity theory provides a framework for evaluation of base resistance for cases where the bearing rock can be characterized by its Geological Strength Index (GSI). This applies to intact (massive) rock or highly fractured rock. Massive rock can be defined, for purposes of bearing capacity analysis, as rock mass for which the effects of discontinuities are insignificant. Practically, if joint spacing is more than four to five times the shaft diameter, or if jointing is horizontal but the joints are tight (no compressible or gouge-filled seams) the rock can be treated as massive. Highly fractured rock describes a rock mass intersected by multiple sets of intersecting joints such that the strength is controlled by the overall mass response and not by failure along pre-existing structural discontinuities. This generally

applies to rock that can be characterized by the descriptive terms shown in Figure 3-10 (e.g., “blocky”, “disintegrated”, etc.). The approach is summarized from Turner (2006) as follows. Let:

$$A = \sigma'_{vb} + q_u \left[ m_b \left( \frac{\sigma'_{vb}}{q_u} \right) + s \right]^a \quad 13-24$$

where  $\sigma'_{vb}$  = vertical effective stress at the socket bearing elevation (tip elevation). The nominal base resistance is then given by:

$$q_{BN} = A + q_u \left[ m_b \left( \frac{A}{q_u} \right) + s \right]^a \quad 13-25$$

in which the coefficients  $s$ ,  $a$ , and  $m_b$  are the Hoek-Brown strength parameters for the intact or fractured rock mass determined as functions of GSI in Equations 3-26 through 3-28 and Table 3-8. An earlier version of Equation 13-25 is presented in AASHTO (2007) for the case of  $\sigma'_{vb} = 0$  and with the Hoek-Brown strength parameters based on correlation to Rock Mass Rating (RMR). As described in Chapter 3, GSI provides an improved correlation for rock mass engineering properties and should be used in place of RMR as the basis for estimating strength parameters. Equation 13-20 with  $N_{cr}^*$  equal to 2.5 can be used as an upper-bound limit to base resistance calculated by Equation 13-25, unless local experience or load tests can be used to validate higher values. Additional background on the derivation of Equation 13-25 and discussion on the application of this method are presented in Appendix C. Resistance factors have not been established for this method.

#### **Additional Design Considerations for Rock Sockets:**

A design decision to be addressed when using rock sockets is whether to neglect one or the other component of resistance (side or base) for the purpose of evaluating strength limit states. With regard to base resistance, AASHTO Article C.10.8.3.5.4a states “Design based on side-wall shear alone should be considered for cases in which the base of the drilled hole cannot be cleaned and inspected or where it is determined that large movements of the shaft would be required to mobilize resistance in end bearing” (AASHTO, 2007). The philosophy embraced in the above comment gives a designer the option of neglecting base resistance. However, before making this decision, careful consideration should be given to applying available methods of quality construction and inspection that can provide confidence in base resistance. A growing body of evidence suggests that good construction practices can result in adequate clean-out at the base of rock sockets, including those constructed by wet methods. Inspection tools, such as the Shaft Inspection Device (SID), probing tools, borehole calipers (see Section 19.2.4), and others, can be applied more effectively to ensure quality of rock sockets prior to concrete placement (Crapps and Schmertmann, 2002; Turner, 2006). Under most conditions, the cost of quality control and assurance is offset by the economies achieved in socket design by including base resistance. Several State DOT’s have utilized load testing to develop confidence in the use of base resistance in rock formations where base resistance had previously been neglected due to uncertainty.

Reasons cited for neglecting side resistance of rock sockets include (1) the possibility of strain-softening behavior of the sidewall interface, (2) the possibility of degradation of material at the borehole wall in argillaceous rocks, and (3) uncertainty regarding the roughness of the sidewall. Brittle behavior along the sidewall, in which side resistance exhibits a significant decrease beyond its peak value, is not commonly

observed in load tests on rock sockets. If there is reason to believe strain softening will occur, laboratory direct shear tests of the rock-concrete interface can be used to evaluate the load-deformation behavior and account for it in design. These cases would also be strong candidates for conducting field load tests. Investigating the sidewall shear behavior through laboratory or field testing is generally more cost-effective than neglecting side resistance in the design. Application of quality control and quality assurance through inspection is also necessary to confirm that sidewall conditions in production shafts are of the same quality as laboratory or field test conditions.

Materials that are prone to degradation at the exposed surface of the borehole and are prone to a “smooth” sidewall generally are sedimentary rocks such as shale, claystone, and siltstone. Degradation occurs due to expansion, opening of cracks and fissures combined with groundwater seepage, and by exposure to air and/or water used for drilling. Hassan and O’Neill (1997) note that in the most severe cases degradation results in a smear zone at the interface. Smearing may reduce load transfer significantly. As reported by Abu-Hejleh et al. (2003), both smearing and smooth sidewall conditions can be prevented in cohesive IGMs by using roughening tools during the final pass with the rock auger or by grooving tools. Careful inspection prior to concrete placement is required to confirm roughness of the sidewalls. Only when these measures cannot be confirmed would there be cause for neglecting side resistance in design. When new tools are introduced for drilling in rock, inspection of the sidewall for roughness is necessary to confirm that the method results in a rough interface.

Illustrative Example 13-3 demonstrates the calculation of side and base resistances in a rock-socketed drilled shaft. The example illustrates the large capacity contributed by base resistance in a relatively small rock socket. In order to take advantage of the available base resistance it would be important to specify proper base cleanout methods and to verify base conditions through appropriate inspection.

#### 13.3.5.4 Cohesive IGM (Fine-Grained Sedimentary Rock)

##### *Side Resistance*

For drilled shafts socketed into argillaceous rock (shale, claystone, siltstone etc.) Hassan et al. (1997) developed a design methodology based on detailed modeling, observations from load tests, and lab and field tests commonly used to characterize the compressive strength of weak clay shales that are difficult to sample and test by conventional means. O’Neill et al. (1996) applied the term “cohesive intermediate geomaterials” for the purpose of drilled shaft design in these materials. The design calculations are similar in form to the  $\alpha$ -method described above for cohesive soils, with modifications. The nominal unit side resistance is given by:

$$f_{SN} = \alpha \phi q_u \quad 13-26$$

where:

- $q_u$  = compressive strength of intact rock,
- $\phi$  = a correction factor to account for the degree of jointing, and
- $\alpha$  = empirical factor given in Figure 13-9.

---

### Illustrative Example 13-3. Evaluation of Socket Resistance for Trial Drilled Shaft Design

A drilled shaft is to be installed through soil and socketed into competent limestone. A trial design under consideration includes a socket 2 ft in diameter and 7.5 ft deep, as shown in Figure 13-8. Coring of the limestone shows RQD values ranging from 70 to 100. Uniaxial compression tests on intact core samples at natural water content yields an average uniaxial compressive strength of  $q_u = 870$  psi. Compute the nominal side and base resistances for the socketed portion of the trial shaft. Construction experience in this formation indicates the socket can be excavated with a rock auger and will remain stable without the use of casing.

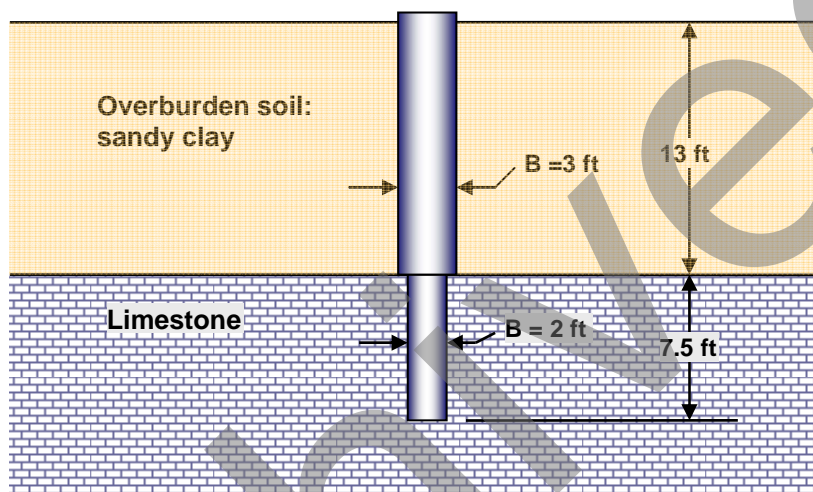


Figure 13-8 Ground Profile and Trial Shaft for Illustrative Example 13-3

Unit side resistance:

By Equation 13-18: 
$$f_{SN} = p_a \times C \sqrt{\frac{q_u}{p_a}} = 14.69 \text{ psi} \times 1.0 \sqrt{\frac{870}{14.69}} = 113.0 \text{ psi} = 16,279 \text{ psf}$$

Nominal side resistance: 
$$R_{SN, \text{socket}} = 16,279 \frac{\text{lb}}{\text{ft}^2} \times \pi \times 2 \text{ ft} \times 7.5 \text{ ft} = 767,130 \text{ lb} = \underline{767.1 \text{ kips}}$$

Unit base resistance:

By Equation 13-20: 
$$q_{BN} = N_{cr}^* q_u = 2.5 (870 \text{ psi}) = 2,175 \text{ psi} = 313,200 \text{ psf}$$

Nominal base resistance: 
$$R_{BN, \text{socket}} = 313,200 \frac{\text{lb}}{\text{ft}^2} \times \frac{\pi}{4} (2 \text{ ft})^2 = 983,947 \text{ lb} = \underline{983.9 \text{ kips}}$$

---

The method is applicable for the range of conditions shown in the figure, where  $E_m$  = modulus of the rock mass,  $\sigma_n$  = fluid pressure exerted by the concrete at the time of the pour,  $\sigma_p$  = atmospheric pressure in the same units as  $\sigma_n$ , and  $w_t$  = total vertical displacement required to mobilize the full side resistance, assumed to be 1 inch (25 mm). As indicated in Figure 13-9, the method is based on an assumed value of

interface friction angle  $\phi_{rc} = 30$  degrees. If it is known that a different value of interface friction applies, then the parameter  $\alpha$  can be adjusted by:

$$\alpha = \alpha_{Figure13-8} \frac{\tan \phi_{rc}}{\tan 30^\circ} \quad 13-27$$

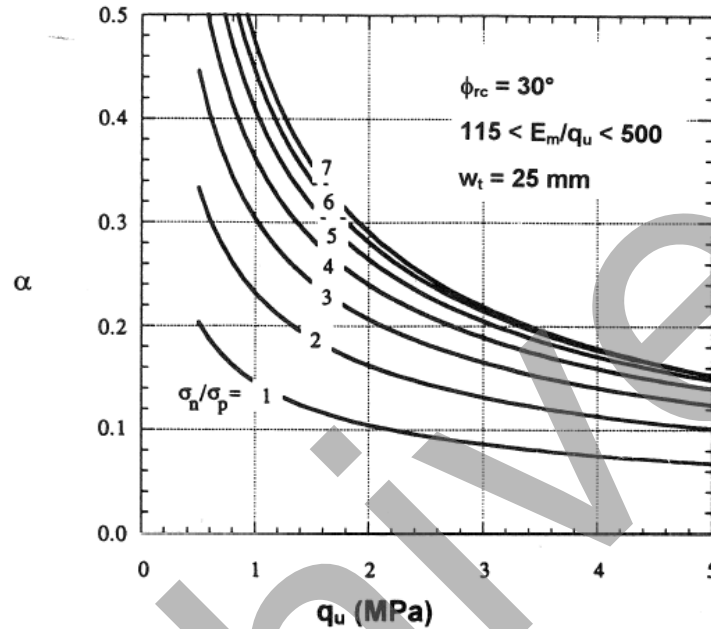


Figure 13-9 Factor  $\alpha$  for Cohesive IGM (O'Neill et al. 1996) (25 mm = 1 inch; 1 MPa = 20.9 ksf)

In order to estimate  $\alpha$  from Figure 13-9, the designer must first estimate the pressure transmitted by the fluid concrete at the middle of Layer  $i$ ,  $\sigma_n$ . If the slump of concrete with unit weight  $\gamma_c$  is kept at or above 7 inches as it is placed and the concrete is placed in the borehole at the rate of 40 ft per hour or greater, then  $\sigma_n$  at a depth of  $z_i^*$  below cutoff elevation of up to 40 ft can be estimated from Equation 13-30.  $\sigma_n$  at greater depths should be taken to be equal to the value at  $z_i^* = 40$  ft.

$$\sigma_n = 0.65 \gamma_c z_i^* \quad 13-28$$

In Equation 13-26,  $\phi$  (not to be confused with resistance factor) is a joint-effect factor that accounts for the presence of open joints that either are voided or contain soft gouge. The factor  $\phi$  can be estimated from Table 13-3 presented previously for jointed rock. Values cannot be recommended for materials with RQD values less than about 20 per cent. The existence of such a condition strongly suggests a need to conduct load tests to establish side resistance.

The resistance factor for the above method of  $\phi = 0.60$  (Table 10-5) is recommended by Allen (2005) on the basis of reliability calibration studies of Paikowsky et al. (2004).

In Equation 13-26,  $q_{u,i}$  is the design value for  $q_u$  in Layer  $i$ . This is often taken to be the mean value from uniaxial compression tests on intact cores of 2 inches in diameter or larger. For material in which it is not possible to obtain suitable core samples for lab testing, Cavusoglu et al. (2004) developed correlations

between  $q_u$  and results of the Texas Cone Penetration Test that are applicable to clay shales of the Eagle Ford Formation, commonly encountered in the Dallas area and other regions of Texas and Oklahoma. The existence of weaker material between the intact geomaterial that could be sampled is also considered through the factor  $\phi$ . Weak clay shales of the Denver Formation and other units encountered in Colorado can also be evaluated using the above method. For these units, correlations have been developed between rock compressive strength,  $q_u$ , and Standard Penetration Test N-values, and also directly between unit side resistance and N-values, as given by Abu-Hejleh et al. (2003). The correlations for these materials are presented in Appendix B.

### *Base Resistance*

The methods presented above for base resistance of shafts in rock are applicable to base resistance of shafts in argillaceous rock (shale, mudstone, siltstone), including materials classified as cohesive IGM by O'Neill et al. (1996). In particular, O'Neill et al. (1996) found that Equations 13-21 through 13-23 are applicable to cohesive IGMs when the criterion of being horizontally bedded sedimentary rock is satisfied and information on joint spacing and joint aperture thickness are available.

### **13.3.6 Evaluate Trial Design for Strength Limit States (Step 11-6)**

This step involves application of resistance factors to the nominal resistances determined in Step 11-5, followed by evaluation of each strength limit state established in Step 11-2, for each loading mode established in Step 11-3, and for each trial design (Step 11-4), to satisfy the strength limit state condition expressed by Equation 13-1:

$$\sum \eta_i \gamma_i F_i \leq \sum \phi_i R_i \quad 13-1$$

Recommended resistance factors for use with nominal resistances calculated by the methods described above are presented in Table 10-5. Note that when compressive resistances are determined on the basis of one or more static load tests, AASHTO (2007) allows for a resistance factor value as high as 0.70. The actual value selected is a matter of engineering judgment and should account for the number of load tests conducted and the level of subsurface variability. This issue is discussed in Chapter 10 (Section 10.4).

### **13.3.7 Evaluate Trial Design for Service Limit States (Step 11-7)**

Foundation settlement criteria are based on considerations that account for the function and type of structure, anticipated service life, and consequences of unacceptable movements on structural performance. Several studies have been conducted on tolerable settlement for bridges (Moulton et al., 1985, Barker et al., 1991) and these have led to some simple rule-of thumb criteria. For example, a tolerable angular distortion between adjacent foundations is often taken as 0.008 radians in simple spans and 0.004 radians in continuous spans. However, other factors may be taken into account, such as foundation costs, rideability, deck cracking, aesthetics, and others. Therefore, movement criteria are established on a site-specific basis and the foundation designer must work closely with the bridge structural engineer to establish settlement limits for each structure. According to a survey of transportation agencies reported by Paikowsky et al. (2004) tolerable settlement for bridge foundations typically ranges from 0.25 to 2.0 inches.

The serviceability limit state is defined by the axial load that results in the tolerable axial deformation,  $\delta_{\text{service}}$ . Once the tolerable axial deformations have been established, each trial design is analyzed for axial load-deformation behavior and evaluated against the LRFD criterion:

$$\sum \eta_i \gamma_i F_i \leq \sum \phi_i R_i$$

13-1

Resistances ( $R_i$ ) on the right side of Equation 13-1 are the values corresponding to the tolerable axial deformation and the resistance factors ( $\phi_i$ ) are *serviceability* values, currently taken as unity in the AASHTO Specifications (AASHTO, 2007). The load factors ( $\gamma_i$ ) on the left side of Equation 13-1 are for serviceability limit states, also currently taken equal to unity. The analysis required to evaluate a service limit state involves determination of the axial load that results in a specified value of axial deformation. Three methods are presented here. The first method is amenable to hand calculations and is based on observations from load tests. This method is useful for making settlement estimates for single drilled shafts in soil during preliminary design, or to determine that settlement will likely not be critical to the performance of the structure. The second method is based on numerical simulation of axial load transfer and requires an estimate of the load transfer function for each geomaterial layer through which the shaft derives its resistance. This method is normally executed with the use of computer software and is recommended for design of shafts in layered soil and rock profiles, for planning load tests, and in cases where settlement can potentially govern the design. A third method is presented for predicting settlement of shafts bearing on or socketed into rock or other very dense geomaterials. This method is based on approximations derived from elasto-plastic solutions and is amenable to spreadsheet calculations. The first method is presented below followed by an illustrative example. A general overview is then presented for the second and third methods, with further details given in Appendix D.

#### *Cohesionless and Cohesive Soils, Simple Method*

A simple method for estimating the load-deformation behavior of drilled shafts in axial compression is based on modeling the average behavior observed from field load testing. For this purpose, load test data are presented in normalized form, in which axial force is normalized by the nominal resistance (summation of predicted side and base resistances) and plotted against displacement ( $\delta$ ) normalized by shaft diameter,  $B$ . A normalized load-displacement curve representing the average observed behavior can then be used as a very approximate guide for estimating axial displacements under service load conditions. The principal limitation of this approach is that “average” curves developed in this manner are based on data that typically exhibit large degrees of variability (scatter). Axial deformation predicted from the resulting curve does not represent a rigorous analysis based on site-specific soil properties, but rather a crude first-order estimate considering average behavior. The advantage of this approach lies in its simplicity and ease of use. It is most suitable for conducting preliminary analyses of trial designs or as a means of conducting service limit state checks to establish whether axial deformation is likely to be of significant concern.

In the previous version of this manual (O’Neill and Reese, 1999), normalized load-deformation curves, referred to as load transfer curves, were presented separately for side resistance and base resistance. Analysis of axial deformation required iterating between the two figures. The curves presented herein, based on Chen and Kulhawy (2002), combine the side and base resistances into single curves representing both components of axial resistance. The model was developed primarily as a way to provide consistent interpretation of load test results. The data used to develop the curves include the load test data used by O’Neill and Reese (1999) plus additional load test data collected by the method’s developers. The resulting curves are easier to use and incorporate a larger amount of load test data.

Figure 13-10 presents normalized load-displacement curves for drilled shafts in soil under axial compression. Two curves are shown to differentiate between undrained loading in cohesive soils (dashed line) and drained loading in cohesionless soils (solid line). The figure is adapted from Chen and Kulhawy

(2002) based on analysis of a worldwide database of compression load tests on straight-sided shafts. The analysis for cohesionless soils is based on 46 data points while the curve for cohesive soils is based on 56 data points. The model is explained further in Appendix C (see Figure C-4). In Figure 13-10 each load-displacement curve is defined by the following three regions:

1. From the origin to a normalized displacement ( $\delta/B$ ) of 0.4% the behavior is linear. The upper end of this region corresponds to a normalized axial compressive force of 50%.
2. Between normalized displacements of 0.4% and 4.0% the response is nonlinear as the shaft yields. The normalized axial force at  $\delta/B = 4.0\%$  is considered the interpreted failure load or “failure threshold”.
3. Beyond the failure threshold is the final linear region. For cohesive soils this final region is represented by a constant resistance corresponding to a normalized axial force of 100%. For cohesionless soils the shaft resistance continues to increase in response to the large displacement required to mobilize base resistance.

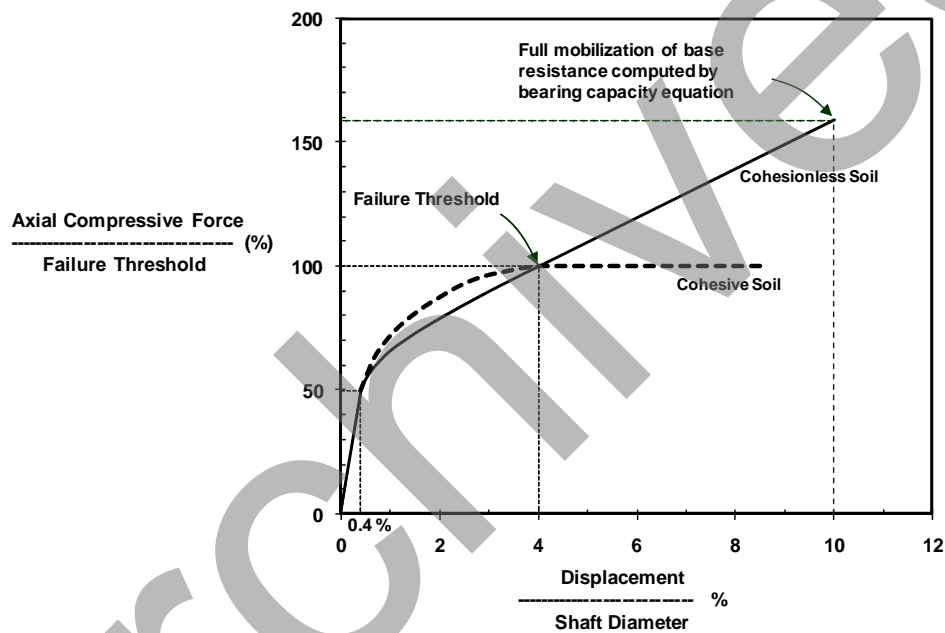


Figure 13-10 Normalized Load-Displacement Curve, Drilled Shaft in Axial Compression (Adapted from Chen and Kulhawy, 2002)

In developing the average curves shown in Figure 13-10, Chen and Kulhawy (2002) considered the axial force acting on the shaft to consist of the force applied to the butt (top) of the shaft plus the weight of the shaft ( $W$ ). For cohesive soils, the failure threshold, or nominal axial resistance, corresponds to mobilization of the full available side resistance ( $R_{SN}$ ) plus the full available base resistance ( $R_{BN}$ ). In cohesionless soils, the failure threshold is the force corresponding to mobilization of the full side resistance ( $R_{SN}$ ) plus the base resistance corresponding to  $\delta/B = 4.0\%$  ( $R_{BN\ 4.0\%}$ ). The reader will note that nominal base resistance in cohesionless soils is calculated in this manual using the empirical correlation given by Equation 13-14, in terms of  $N$ -value. That relationship was developed using base resistance corresponding to 5 percent normalized displacement. To use the cohesionless soil curve depicted in Figure 13-10, therefore, the base resistance calculated by Equation 13-14 must be corrected to a normalized displacement of 4 percent. This requires multiplying the base resistance from Equation 13-14 by a factor of 0.71. This number is simply the ratio of tip resistances mobilized at 4 percent and 5 percent normalized displacements, respectively.



Additional limitations of Figure 13-10 are that the data used in its development include drilled shafts with diameters ranging from 1 ft to 6.5 ft, depths ranging from 16 ft to 200 ft, and depth to diameter ratios ranging from 5.8 to 56.4. Use of the curves shown in the figure should be limited to drilled shafts with geometries falling within these ranges. In the analysis of field load tests used to develop Figure 13-10, shaft displacements were taken as the measured butt displacement and therefore incorporate elastic compression of the concrete shaft.

Figure 13-10 can be used to make a first-order estimate of the settlement of straight-sided shafts in soils as follows:

1. The failure threshold is computed as the sum of nominal side and base resistances calculated in Step 11-6:

$$\text{failure threshold} = R_{SN} + R_{BN} = Q_c + W \quad 13-29$$

in which  $R_{SN}$  and  $R_{BN}$  are nominal side and base resistances, respectively,  $Q_c$  is the compressive force applied at the top of the shaft, and  $W$  = weight of the drilled shaft. The weight term is the effective weight of the foundation, given by the total weight above the water table and the buoyant weight below the water table.

2. In Equation 13-29, the nominal resistances  $R_{SN}$  and  $R_{BN}$  for shafts in cohesive soils are calculated using the equations presented in Section 13.3.5.2. For cohesionless soils,  $R_{SN}$  is calculated using the beta method as presented in Section 13.3.5.1, while the base resistance is calculated by multiplying by 0.71 the value obtained by the use of Equation 13-14, as explained above (corresponding to nominal base resistance at 4.0% normalized settlement).
3. Divide the tolerable settlement,  $\delta_{\text{service}}$ , by the shaft diameter to obtain the normalized displacement ( $\delta_{\text{service}}/B$ ) expressed as a percentage.
4. Enter Figure 13-10 with the normalized displacement from Step 2 and, using the appropriate curve, determine the corresponding normalized axial force.
5. Divide the normalized force by 100% and multiply by the “failure threshold” load to obtain the Axial Compressive Force. This force =  $R_{\text{service}} + W$ , where  $R_{\text{service}}$  = applied axial compressive force corresponding to the tolerable settlement. Subtract the shaft weight from the Axial Compressive Force to obtain  $R_{\text{service}}$ .
6. Substitute the value  $R_{\text{service}}$  into the right-hand side of Equation 13-1 to evaluate the service limit state criterion (*i.e.*, a service limit state check).

The methods used by Chen and Kulhawy (2002) to calculate the other components of resistance are:  $\beta$ -method for side resistance in cohesionless soils;  $\alpha$ -method for side resistance in cohesive soils; and bearing capacity theory for base resistance in cohesive soils. These are the methods presented in Section 13.3.3; however, there are differences in the equations for  $\alpha$  given in this manual and those used to develop the curve for cohesive soil. The figure is still suitable for making simple, approximate calculations of axial load-deformation behavior, keeping in mind that both curves represent average behavior and are not to be considered as rigorous analytical predictions.

Figure 13-10 is also a reasonable tool for making preliminary estimates of load-settlement behavior for shafts in mixed soil profiles. In calculating the failure threshold, the nominal base resistance must account for the soil type providing base resistance. This will also determine which of the two curves (cohesionless soil or cohesive soil) to use for evaluation of settlement.

The following example is presented to illustrate the application of this method to a trial drilled shaft design in cohesionless soil.

---



---

**Illustrative Example 13-4      Strength and Service Limit State Evaluation of Trial Shaft in Cohesionless Soil**

In this example, a trial drilled shaft design is checked for Strength Limit State I and Service Limit State I loading conditions. It is assumed that structural modeling of the superstructure, incorporating the trial foundation design, has been conducted and the factored axial force effects and tolerable settlement provided by the structural engineer are as follows:

Strength Limit State I, compression loading:	$\Sigma \eta\gamma F = 1,050$ kips
Service Limit State I:	tolerable axial settlement = 1.5 inch
	under nominal compressive load = 765 kips

In the first part of this example, factored side and base resistances are computed, based on idealized subsurface conditions. In the second part, Figure 13-10 is used to evaluate the load-settlement response of the trial design to check the service limit state.

**Subsurface profile:** Based on borings performed at the location of the bridge pier, the idealized subsurface profile is shown in Figure 13-11. The profile consists of two geomaterial layers, a top layer consisting of silty sand (SM) from the ground surface to a depth of 18 ft underlain by a deep deposit of dense sandy gravel. The groundwater table (piezometric surface) is 22 ft below the ground surface. For purposes of computing side resistance, four layers will be used, as shown in Figure 13-11. The silty sand will be subdivided into two layers, one extending from the surface to a depth of 7.5 ft. This layer is selected to accommodate the limiting value of  $\beta$  at shallow depths, as described in Section 13.3.5.1. The gravel is subdivided into two layers to accommodate the differences in effective stress computations for soil above versus below the water table. All resistances are evaluated in terms of effective stress.

**Trial shaft dimensions:**                      Diameter = 60 inches (5 ft), depth = 45 ft

For illustrative purposes, it is assumed that Standard Penetration Test N-values have been corrected for effective overburden stress and the average value determined for each layer. Average values of both the uncorrected ( $N_{60}$ ) and corrected ( $(N_1)_{60}$ ) numbers are presented below. Also, an average unit weight is assumed for each layer.

Depth Interval (ft)	Layer Thickness (ft)	Average $N_{60}$	Average $(N_1)_{60}$	Total Unit Weight, $\gamma_t$ (lb/ft <sup>3</sup> )
0 - 7.5	7.5	15	29	112
7.5 - 18	10.5	21	21	115
18 - 22	4.0	45	43	120
22 - 46	23.0	52	38	125

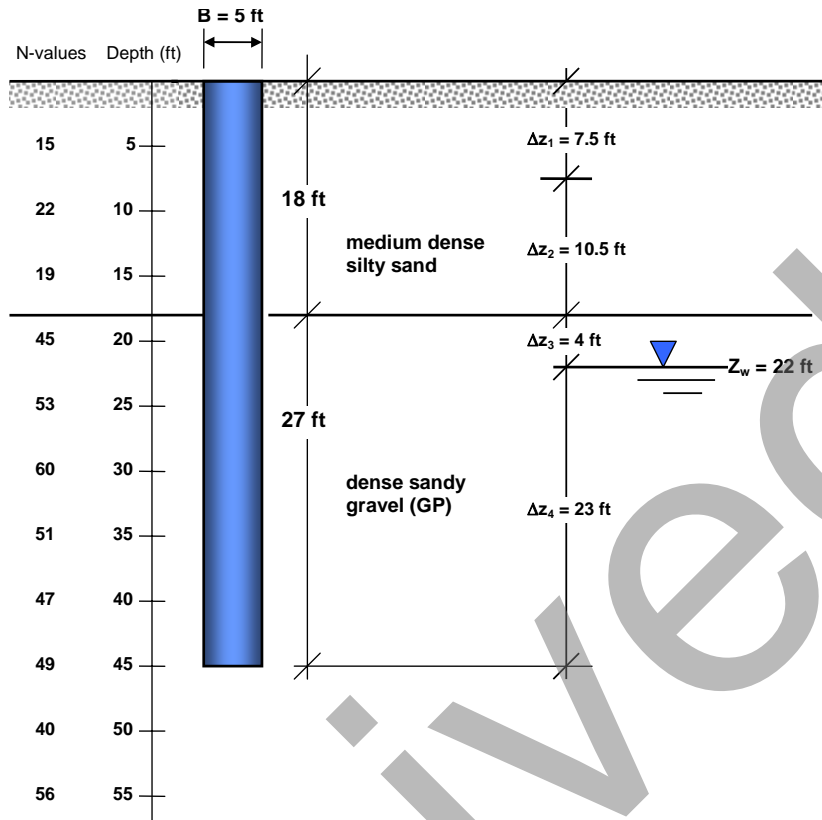


Figure 13-11 Idealized Subsurface Profile and Drilled Shaft Trial Dimensions, Illustrative Example 13-4

**Calculations:**

Side Resistance:

Layer 1.

$$\sigma'_v \text{ @ mid-depth} = 3.75 \text{ ft} \times 112 = 420 \text{ psf}$$

Evaluation of  $\beta$  at  $z = 7.5$  ft:

$$\sigma'_v \text{ @ } 7.5 \text{ ft} = 7.5 \text{ ft} \times 112 = 840 \text{ psf}$$

$$\phi' = 27.5 + 9.2 \log[29] = 41^\circ$$

by: Eq. 3-8

$$\sigma'_p \approx 2,116 \times 0.47 (15)^{0.8} = 8,679 \text{ psf}$$

Eq. 13-11

$$OCR = \frac{8,679}{840} = 10.33$$

Eq. 13-9

$$K_o = (1 - \sin 41^\circ) 10.33^{\sin 41^\circ} = 1.59 \leq K_p (= 4.81)$$

Eq. 13-8

$$\text{Where } K_p = \tan^2(45^\circ + \phi/2)$$

Eq. 13-10

$$\beta = K \tan \delta = 1.59 \tan (41^\circ) = 1.38 \quad \text{Eq. 13-6}$$

$$\text{Unit side resistance: } f_{SN} = \sigma'_v \beta = 420 \text{ psf} (1.38) = 581 \text{ psf} \quad \text{Eq. 13-7}$$

Nominal side resistance, Layer 1:

$$R_{SN,1} = \pi B \Delta z f_{SN} = \pi (5 \text{ ft}) (7.5 \text{ ft}) 581 \text{ psf} = 68,417 \text{ lb} = \underline{68.4 \text{ kips}} \quad \text{Eq. 13-5}$$

Layer 2:

$$\sigma'_v \text{ @ mid-depth} = 7.5(112) + 5.25(115) = 1,444 \text{ psf}$$

Evaluation of  $\beta$  at  $z = 12.75 \text{ ft}$  (mid-depth)

$$\phi' = 27.5 + 9.2 \log[21] = 40^\circ \quad \text{by: Eq. 13-8}$$

$$\sigma'_p \approx 2,116 \times 0.47 (21)^{0.8} = 11,360 \text{ psf} \quad \text{Eq. 13-11}$$

$$OCR = \frac{11,360}{1,444} = 7.87 \quad \text{Eq. 13-9}$$

$$K_o = (1 - \sin 40^\circ) 7.87^{\sin 40^\circ} = 1.35 \leq K_p (= 4.51) \quad \text{Eq. 13-8}$$

$$\text{Where } K_p = \tan^2(45^\circ + \phi/2) \quad \text{Eq. 13-10}$$

$$\beta = K \tan \delta = 1.35 \tan (40^\circ) = 1.13 \quad \text{Eq. 13-6}$$

$$\text{Unit side resistance: } f_{SN} = \sigma'_v \beta = 1,444 \text{ psf} (1.13) = 1,632 \text{ psf} \quad \text{Eq. 13-7}$$

Nominal side resistance, Layer 2:

$$R_{SN,2} = \pi B \Delta z f_{SN} = \pi (5 \text{ ft}) (10.5 \text{ ft}) 1,632 \text{ psf} = 269,172 \text{ lb} = \underline{269.2 \text{ kips}} \quad \text{Eq. 13-5}$$

Layer 3:

$$\sigma'_v \text{ @ mid-depth} = 7.5(112) + 10.5(115) + 2(120) = 2,288 \text{ psf}$$

Evaluation of  $\beta$  at  $z = 20 \text{ ft}$  (mid-depth)

$$\phi' = 27.5 + 9.2 \log[43] = 43^\circ \quad \text{by: Eq. 3-8}$$

$$\sigma'_p \approx 2,116 \times 0.15 (45) = 14,283 \text{ psf} \quad (\text{for gravelly soils}) \quad \text{Eq. 13-12}$$

$$OCR = \frac{14,283}{2,288} = 6.24 \quad \text{Eq. 13-9}$$

$$K_o = (1 - \sin 43^\circ) 6.24^{\sin 43^\circ} = 1.12 \leq K_p (= 5.17) \quad \text{Eq. 13-8}$$

$$\text{Where } K_p = \tan^2(45^\circ + \phi/2) \quad \text{Eq. 13-10}$$

$$\beta = K \tan \delta = 1.12 \tan (43^\circ) = 1.03 \quad \text{Eq. 13-6}$$

$$\text{Unit side resistance: } f_{SN} = \sigma'_v \beta = 2,288 \text{ psf } (1.03) = 2,345 \text{ psf} \quad \text{Eq. 13-7}$$

Nominal side resistance, Layer 3:

$$R_{SN,3} = \pi B \Delta z f_{SN} = \pi (5 \text{ ft}) (4 \text{ ft}) 2,345 \text{ psf} = 147,358 \text{ lb} = \underline{147.4 \text{ kips}} \quad \text{Eq. 13-5}$$

Layer 4:

$$\sigma'_v \text{ @ mid-depth} = 7.5(112) + 10.5(115) + 4(120) + 11.5(125-62.4) = 3,247 \text{ psf}$$

Evaluation of  $\beta$  at  $z = 33.5$  ft (mid-depth)

$$\phi' = 27.5 + 9.2 \log[38] = 42^\circ \quad \text{by: Eq. 3-8}$$

$$\sigma'_p \approx 2,116 \times 0.15 (52) = 16,505 \text{ psf} \quad \text{Eq. 13-12}$$

$$OCR = \frac{16,505}{3,247} = 5.08 \quad \text{Eq. 13-9}$$

$$K_o = (1 - \sin 42^\circ) 5.08^{\sin 42^\circ} = 0.98 \leq K_p (= 5.05) \quad \text{Eq. 13-8}$$

$$\text{Where } K_p = \tan^2(45^\circ + \phi/2) \quad \text{Eq. 13-10}$$

$$\beta = K \tan \delta = 0.98 \tan (42^\circ) = 0.88 \quad \text{Eq. 13-6}$$

$$\text{Unit side resistance: } f_{SN} = \sigma'_v \beta = 3,247 \text{ psf } (0.88) = 2,872 \text{ psf} \quad \text{Eq. 13-7}$$

Nominal side resistance, Layer 4:

$$R_{SN,4} = \pi B \Delta z f_{SN} = \pi (5 \text{ ft}) (23 \text{ ft}) 2,872 \text{ psf} = 1,037,698 \text{ lb} = \underline{1,037.7 \text{ kips}} \quad \text{Eq. 13-5}$$

Side resistances of the four layers are summed to obtain the nominal side resistance for the trial shaft:

$$R_{SN} = \Sigma R_{SN,i} = 68.4 + 269.2 + 147.4 + 1,037.7 = \underline{1,523 \text{ kips}}$$

Base resistance:

Referring to Figure 13-10, the base of the shaft is founded in dense sandy gravel. The average  $N_{60}$  value over the depth interval between the base and two diameters below the base is:

$$\text{average } N_{60} = \frac{49 + 40 + 56}{3} = 48$$

Nominal unit base resistance at downward displacement of 5 percent of shaft diameter (3 inches):

$$q_{BN} \text{ (tsf)} = 0.60 N_{60} = 0.60 (48) = 28.8 \text{ tsf} (< 30 \text{ tsf, o.k.}) = 57,600 \text{ lb/ft}^2 \quad \text{Eq. 13-14}$$

Nominal base resistance:

$$R_{BN} = \frac{\pi}{4} (5 \text{ ft})^2 \times 57,600 \frac{\text{lb}}{\text{ft}^2} = 1,130,973 \text{ lb} = \underline{\underline{1,131 \text{ kips}}} \quad \text{Eq. 13-4}$$

#### Check on Strength Limit State I:

By Equation 13-29:

$$\sum \phi_i R_i = \sum_{i=1}^n \phi_{S,i} R_{SN,i} + \phi_B R_{BN} = 0.55(1,523 \text{ kips}) + 0.50(1,131 \text{ kips}) = \underline{\underline{1,403 \text{ kips}}}$$

Limit state check performed by substituting factored force effects and factored resistances into Equation 13-1:

$$\sum \eta_i \gamma_i F_i \leq \sum \phi_i R_i$$

$$1,050 \text{ kips} < 1,403 \text{ kips}$$

Strength Limit State I is satisfied by the trial design

Service Limit State Calculations: using the step-by-step procedure described above

1. By Equation 13-29: failure threshold =  $R_{SN} + R_{BN} = Q_c + W$

where:

$$R_{SN} = 1,523 \text{ kips}$$

$$R_{BN} = 0.71 (1,131 \text{ kips}) = 803 \text{ kips}$$

$$W = \frac{\pi}{4} (5 \text{ ft})^2 [22 \text{ ft}(150 \text{ pcf}) + 23 \text{ ft}(150 - 62.4 \text{ pcf})] = 104,356 \text{ lb} = 104 \text{ kips}$$

$$\text{Failure Threshold} = 1,523 + 803 = 2,326 \text{ kips}$$

2. normalized tolerable displacement:  $\frac{\delta_{\text{tolerable}}}{B} = \frac{1.5 \text{ inch}}{60 \text{ inch}} 100\% = 2.5\%$

3. entering Figure 13-10 with  $\delta/B = 2.5\%$ , normalized axial load = 80%

4.  $R_{\text{service}} + W = 0.80 (2,326 \text{ kips}) = 1,860.8 \text{ kips}$

5.  $R_{\text{service}} = 1,860.8 \text{ kips} - 104.4 \text{ kips} = 1,756.4 \text{ kips}$

6. Service limit state check:  $\sum \eta_i \gamma_i F_i \leq \sum \phi_i R_i$

$765 \text{ kips} < 1,756 \text{ kips}$

Service Limit State I is satisfied by the trial design

Finally, the designer may wish to estimate the expected settlement under the service load. This can be done using Figure 13-10, as follows:

Axial compressive force = Service I axial force +  $W = 765 + 104.4 = 869.4 \text{ kips}$

Normalized axial force = axial compressive force / failure threshold =  $869.4 \text{ kips} / 2,326 \text{ kips} = 0.374$   
 = 37.4 percent

Entering Figure 13-10 with normalized axial force = 37.4%:

Normalized displacement =  $0.4\% \times (37.4/50) = 0.30\%$

Settlement = normalized displacement times shaft diameter =  $0.003 \times 60 \text{ inches} = \underline{\underline{0.18 \text{ inch}}}$

Expected settlement is well within the tolerable settlement of 1.5 inch

### *Numerical Simulation of Load Transfer*

For drilled shafts in layered subsurface profiles and/or where a large number of potential loading cases and trial designs are to be analyzed, numerical simulation of axial load-deformation response provides a practical design tool. In this approach, the drilled shaft and surrounding geomaterials are idealized as a set of linear and nonlinear springs, as illustrated in Figure 13-12. The concrete shaft is modeled by a linear spring to represent its elastic compression or extension in response to axial load. The stiffness of the shaft (spring) is normally constant with depth, although it can be varied. Each geomaterial layer is replaced by a nonlinear spring representing the axial load transfer by development of side resistance. This relationship is expressed in terms of the shear stress developed along the interface ( $t$ ) and the relative movement between the shaft and geomaterial ( $z$ ). The mechanism representing this  $t$ - $z$  curve consists of a cantilever spring and friction block, as shown in Figure 13-12b. A single nonlinear spring is also applied to represent the base load transfer in terms of unit base resistance ( $q$ ) versus base displacement ( $w_b$ ). The  $t$ - $z$  and  $q$ - $w_b$  curves, shown in Figure 13-12c, can be represented by analytical functions.

Based on the model shown in Figure 13-12, a differential equation can be written that satisfies equilibrium and compatibility between the load and deformation at any point along the shaft. Additional details, including the governing differential equation, are presented in Appendix D. The governing differential equation with appropriate mathematical functions to model the  $t$ - $z$  and  $q$ - $w_b$  curves and boundary conditions (axial load) can then be solved numerically, usually through a finite difference scheme, to obtain a simulated load-deformation curve for the axially loaded drilled shaft. Commercially available computer software is generally used for this purpose.

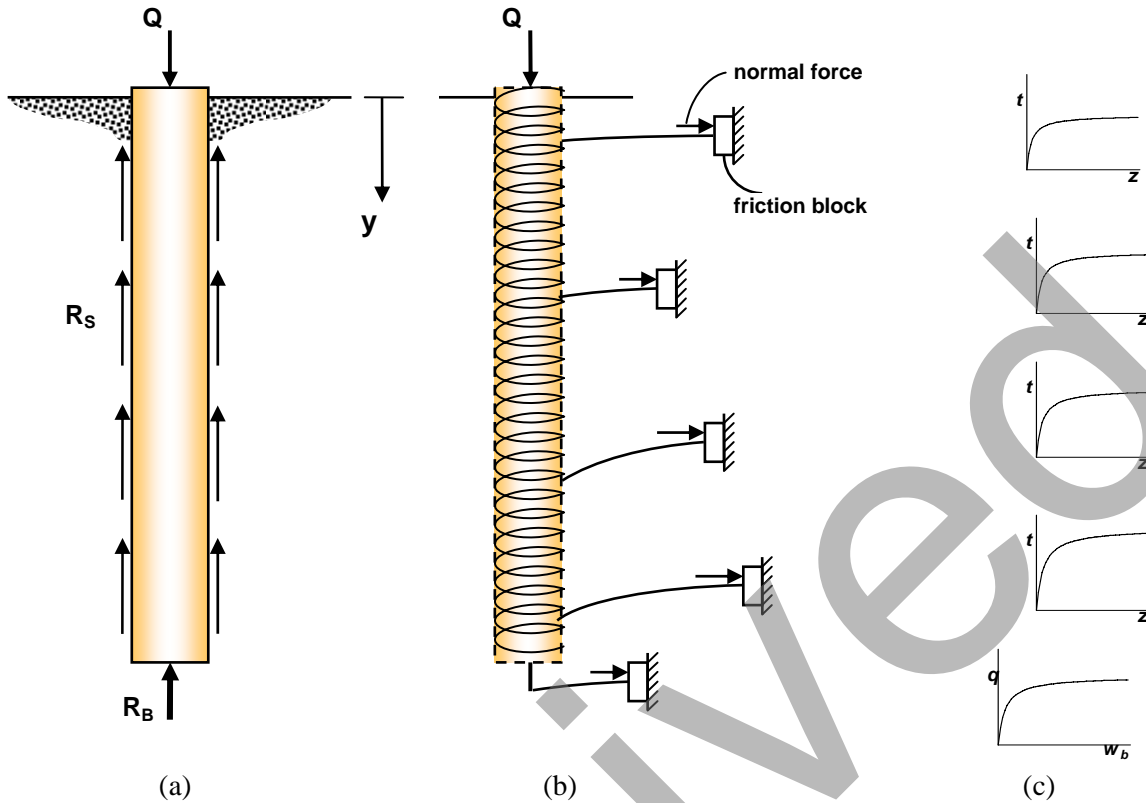


Figure 13-12 Mechanistic Model of Axially Loaded Drilled Shaft (after Reese et al., 2006)

The accuracy of computer-generated solutions to this problem depends entirely on the accuracy of the  $t$ - $z$  and  $q$ - $w_b$  curves (load transfer curves) used as input. When using commercial software, the user normally has the option of inputting load transfer curves developed specifically for the site conditions, or using load transfer curves generated internally by the program based on soil type (cohesive or cohesionless) and nominal unit side resistance ( $f_{NS}$ ) for each layer. It is emphasized that research has not yet advanced to the point that load transfer curves can be predicted with confidence for all conditions encountered in practice. Additionally, the load transfer behavior of some geomaterials may be sensitive to construction practices. On major projects, it is advisable to conduct one or more field load tests during the design phase, with instrumentation to measure load transfer curves. The computer program can then be calibrated by modifying the input information to achieve agreement with the measured curves. The calibrated, site-specific curves can then be used to analyze trial designs, which may vary from the test shaft in geometry and stiffness.

#### Approximate Closed-Form Solutions

Several researchers have developed approximate solutions to the load-displacement behavior of drilled shafts embedded in stiff materials, such as rock or very dense geomaterials, that agree well with more advanced analytical models based on theories of elasticity and plasticity, finite element analysis, and detailed back-analysis of field load tests. The resulting closed-form solutions offer the advantage of being easily implemented in a spreadsheet format, thus providing a convenient desktop tool for the foundation designer. The equations are too detailed for presentation in this chapter and are given in Appendix D. A brief overview of the available methods and their applicability is given below.



The basic problem is depicted in Figure 13-13 and involves predicting the relationship between an axial compression load ( $Q_c$ ) applied to the top of a socketed drilled shaft and the resulting axial displacement at the top of the socket ( $w_c$ ). The concrete shaft is modeled as an elastic cylindrical inclusion embedded within an elastic rock mass. The cylinder of depth  $D$  and diameter  $B$  has Young's modulus  $E_c$  and Poisson's ratio  $\nu_c$ . The rock mass surrounding the cylinder is homogeneous with Young's modulus  $E_r$  and Poisson's ratio  $\nu_r$  while the rock mass beneath the base of the shaft has Young's modulus  $E_b$  and Poisson's ratio  $\nu_b$ . The shaft is subjected to a vertical compressive force  $Q_c$  assumed to be uniformly distributed over the cross-sectional area of the shaft resulting in an average axial stress  $\sigma_b = 4Q_c/(\pi B^2)$ .

Approximate closed-form solutions are given in Appendix D for the cases of:

1. Rock socketed shafts by Carter and Kulhawy (1988);
2. Shafts in dense cohesionless soils with SPT N-values > 50 by Mayne and Harris (1993), and
3. Shafts socketed into weak argillaceous rocks (cohesive IGM) by O'Neill et al. (1996). The required input parameters for each method are discussed.

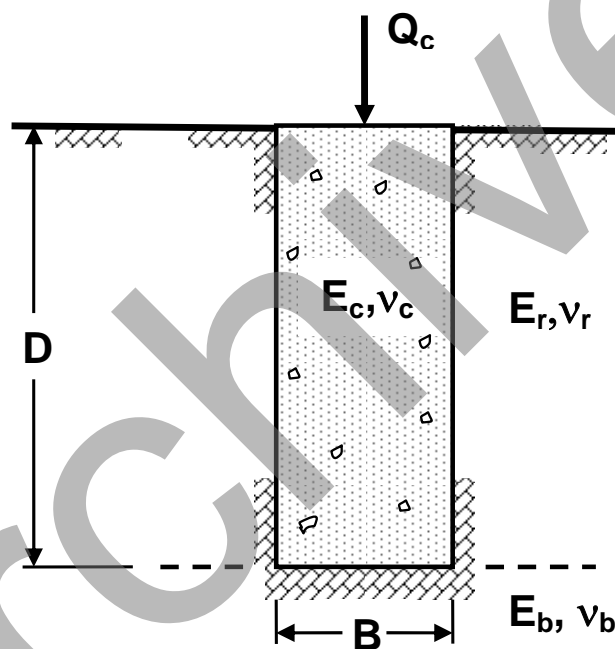


Figure 13-13 Axially Loaded Shaft in Rock or Very Hard Geomaterial, Elastic Analysis

### 13.3.8 Final Trial Design for Axial Compression

The step by step procedure presented above is implemented through an iterative process. Trial designs (Step 11-4) are evaluated for LRFD strength limit states (Steps 11-5 and 11-6) and service limit states (Step 11-7). If a trial design fails to satisfy one or more of the required limit states, or if the trial design greatly exceeds all of the required limit states and a more economical design is possible, dimensions of the trial design are modified and re-analyzed through Steps 11-5, 11-6, and 11-7. This process is continued until all applicable limit states for axial compression satisfy the LRFD criterion (Equation 13-1). For compression, this portion of design for axial loading constitutes completion of the step-by-step procedure depicted in Figure 13-2, which constitutes Block 11 of the overall design process, as discussed in Section 13.2.

## 13.4 DESIGN FOR UPLIFT

Loads acting on deep foundations supporting transportation structures may include uplift. A typical uplift case occurs when a foundation for a bridge pier consists of multiple shafts beneath a footing or pile cap. Structural force effects transmitted to the top of footing may consist of nominal axial compression,  $Q_N$ , and nominal bending moment,  $M_N$ , as shown in Figure 13-14. The moment is resisted by the force couple provided by uplift resistance of drilled shafts on one side of the footing and compressive resistance provided by shafts on the opposite side. In Figure 13-14, the clockwise moment transmitted to the footing results in uplift of shafts on the left side and compression of shafts on the right side. When the combined effects of axial compression and moment acting on the entire foundation are considered for an individual shaft, the net force may be uplift.

Other conditions leading to uplift include construction loads induced during erection of concrete segmental girder bridges, vehicular loading on adjacent spans of continuous girders, extreme event loads such as seismic and impact, and others. In all of these cases, the drilled shaft must be evaluated for applicable limit states under the uplift force effects.

As illustrated in Figure 13-15, a drilled shaft loaded in uplift is resisted by the weight of the shaft and the side resistance that develops over the cylindrical surface at the interface between the concrete shaft and the geomaterial layers along the sides. The design process follows the same general steps presented in Section 13.2 for axial compression, as summarized in the flowchart of Figure 13-2. For each design zone an idealized profile is developed, as illustrated in Figure 13-15. Each layer within the zone is assigned a layer number  $i$ , thickness ( $\Delta z_i$ ), and geomaterial type.

Strength limit states to be satisfied and the corresponding uplift loads and load factors for each foundation are established in consultation with the project structural engineer and in accordance with Section 3 of the AASHTO LRFD Bridge Design Specifications (AASHTO, 2007). For each limit state, appropriate strength properties for each geomaterial layer are assigned. Trial lengths and diameters are selected for analyses. Values of nominal unit side resistance are then computed for each geomaterial layer through which the trial shaft extends. AASHTO Specifications (2007) require the “uplift resistance of a single straight-sided drilled shaft to be estimated in a manner similar to that for determining side resistance for drilled shafts in compression”. Therefore, nominal unit side resistances are computed by the same methods presented in Section 13.3.5 for axial compression loading. In the previous edition of this manual (O’Neill and Reese, 1999) side resistance equations are the same for uplift and compression, but with reduction factors applied for uplift. In the current LRFD specifications (AASHTO, 2007) this issue is addressed by applying lower resistance factors to the computed nominal side resistances for uplift than for compression. The recommended resistance factors are 0.10 less than those for compression, as described by Allen (2005).

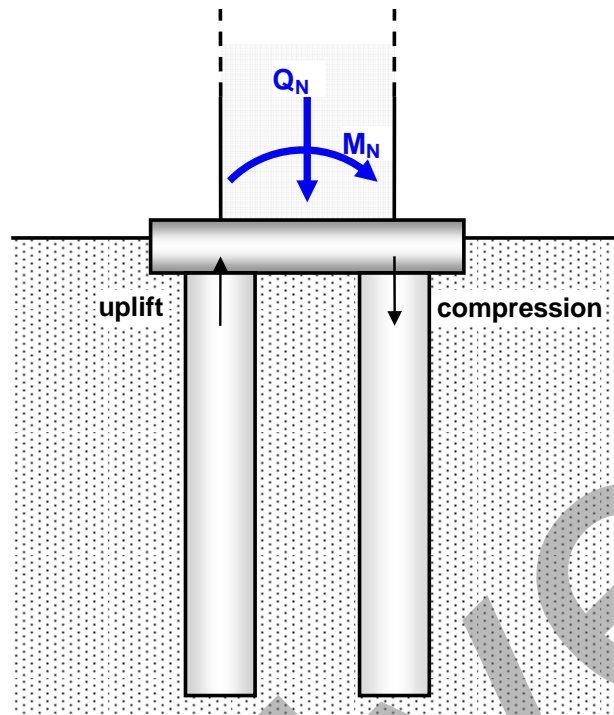


Figure 13-14 Typical Loading Combination Resulting in Uplift

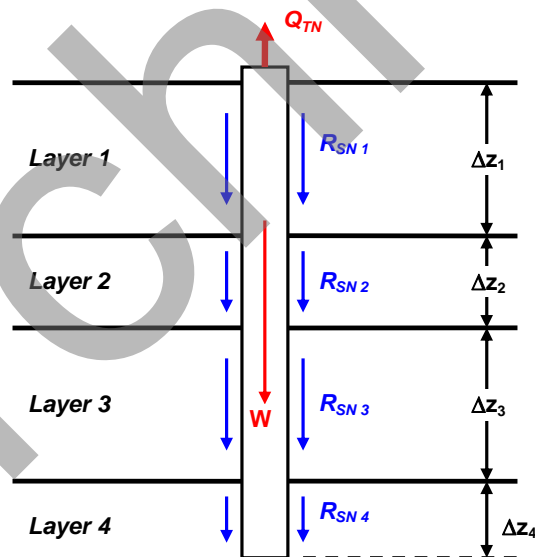


Figure 13-15 Forces and Idealized Geomaterial Layering for Computation of Uplift Resistance

Resistance to uplift may develop at the base of a drilled shaft, as negative porewater pressure (suction) develops in response to the void created between the base of the shaft and underlying ground. In cohesionless soils, any suction would dissipate rapidly, but in cohesive soils (clay), tip suction could be substantial under short-term undrained loading. However, prediction of tip suction for design purposes is not sufficiently reliable and therefore no attempt will be made to incorporate base resistance into design for uplift loading in this manual.

For design purposes the weight of the drilled shaft is treated as a (negative) force effect on the left side of Equation 13-1, rather than as a component of resistance. Accordingly, resistance to axial uplift loading consists only of side resistance and evaluation of the LRFD strength limit state is given by:

$$\sum \phi_i R_i = \sum_{i=1}^n \phi_{S,i} R_{SN,i} \quad 13-30$$

where:

$R_{SN,i}$  = nominal side resistance for layer  $i$ ,  
 $\phi_{S,i}$  = resistance factor for layer  $i$ , and  
 $n$  = number of layers providing side resistance.

Resistance factors for uplift are summarized in Table 10-5 and discussed in Section 10.4. The values presented are less by 0.10 than the equivalent resistance factors for compression, as discussed by Allen (2005) and adopted in the AASHTO Specifications (2007). This approach does not meet the objective of LRFD to establish uniform levels of safety for the various components of a bridge or other structure but is considered an interim procedure pending completion of reliability-based calibration of uplift resistance factors.

Where side resistance values are established on the basis of one or more static uplift load tests conducted at the site of the proposed bridge or other structure, current AASHTO Specifications (2007) allow a resistance factor of 0.60, for all geomaterials. Considerable judgment should be exercised in applying this value, based on the degree to which conditions at the site of production shafts match the conditions of the load test. Factors such as the overall stratigraphy, soil and rock properties, shaft dimensions, and construction method should be essentially similar in order to justify direct application of the load test results to production shafts. Otherwise, a lower resistance factor should be applied. The degree to which the resistance is lowered is based on engineering judgment. If the uplift load is caused by an extreme event, such as earthquake, ice loading, or vessel impact, the resistance value can be taken as 0.80.

The trial design is then evaluated for each applicable strength limit state, using the general form of the LRFD equation:

$$\sum \eta_i \gamma_i F_i \leq \sum \phi_i R_i \quad 13-1$$

where the term on the left-hand side of Equation 13-1 represents the summation of factored uplift force effects, including the buoyant weight of the drilled shaft, and the term on the right-hand side represents the summation of factored resistances given by Equation 13-32. Iterations are made as necessary until the trial design satisfies Equation 13-1.

Uplift resistance of a belled shaft in cohesive soil, though not common in design, is addressed in Appendix C.

## 13.5 DESIGN FOR SCOUR

### 13.5.1 Background and Definitions

Bridge scour is the loss of soil by erosion due to flowing water around bridge supports. Total scour at a highway crossing is comprised of three components:

1. Long-term aggradation and degradation of the river bed
2. General scour at the bridge
  - a. Contraction scour
  - b. Other general scour
3. Local scour at piers or abutments

Aggradation is the gradual and general accumulation of sediments on the river bottom, while degradation is the gradual and general removal of sediments from the riverbed; these are processes predicted to occur without the presence of the bridge. General scour is a lowering of the streambed across the channel at the bridge. General scour may be uniform across the bed or non-uniform and may be caused by contraction or other processes. Contraction describes narrowing of the channel created by the approach embankments and piers of the bridge. Other mechanisms of general scour include flow around a bend where the scour may be concentrated near the outside of the bend. General scour is distinguished from long-term degradation in that general scour may be cyclic and/or related to the passing of a flood.

Local scour is the erosion of material around obstacles to the water flow. It is caused by the localized acceleration of flow and the resulting vortices induced by the obstructions. Local scour occurs at bridge piers and abutments.

Total scour is the sum of long-term degradation, general scour, and local scour. Figure 13-16 illustrates the components of scour that may affect bridges supported on deep foundations. Effects of scour that must be taken into account for drilled shaft design include: (1) changes in subsurface stress, (2) reduced embedment and therefore changes in axial and lateral resistances, and (3) possible changes in the structures response and the resulting foundation force effects (loading).

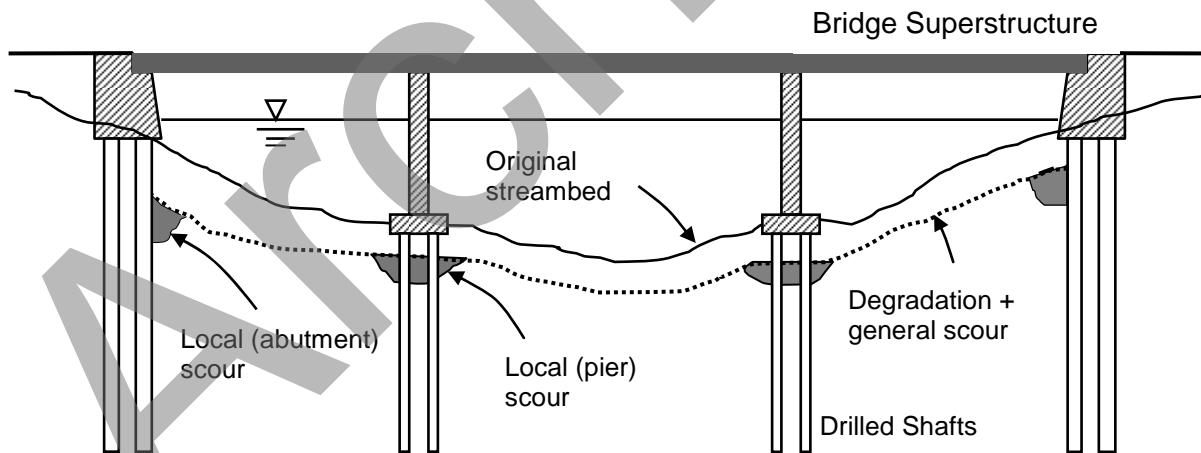


Figure 13-16 Components of Scour Affecting Bridge Supports on Deep Foundations

### 13.5.2 Design Philosophy for Scour

The FHWA document “Evaluating Scour at Bridges” (Richardson and Davis, 2001), commonly known as HEC-18, presents practical methods for analysis of scour and general procedures for design of bridges

susceptible to scour. The following paragraphs state the general approach to bridge scour as given in HEC-18 and consistent with AASHTO (2007) specifications.

Bridge foundations should be designed to withstand the effects of scour without failing for the worst conditions resulting from floods equal to the 100-year flood, or a smaller flood if it will cause scour depths deeper than the 100-year flood (the *design* flood). Bridge foundations should be checked to ensure that they will not fail due to scour resulting from the occurrence of a superflood in order of magnitude of a 500-year flood (the *check* flood). The check flood is an extreme event; the design flood is not an extreme event. Scour due to the design flood is considered for all strength and service limit states for which the bridge is designed.

The approach to design for scour is based on the following concepts:

1. The foundation should be designed by an interdisciplinary team of engineers with expertise in hydraulic, geotechnical, and structural design.
2. Hydraulic studies of bridge sites are a necessary part of a bridge designed over water. These studies should address both the effects of the bridge on the waterway and calculations of scour at the bridge foundations. The scope of the analysis should be commensurate with the complexity of the channel hydraulics and the consequences of failure.
3. Consideration must be given to the limitations and gaps in existing knowledge when using currently available formulas for estimating scour. The designer needs to apply engineering judgment in comparing results obtained from scour computations with available hydrologic and hydraulic data to achieve a reasonable and prudent design. Such data should include:
  - a. Performance of existing structures during past floods
  - b. Effects of regulation and control of flood discharges
  - c. Hydrologic characteristics and flood history of the stream and similar streams
  - d. Whether the bridge is structurally continuous
4. The principles of economic analysis and experience with actual flood damage indicate that it is almost always cost-effective to provide a foundation that will not fail, even from a very large flood event or superflood.

### 13.5.3 Analysis and Prediction of Scour

The overall process for addressing scour at bridge sites involves the following three stages of assessment and analysis:

- 1) A stream stability and geomorphic assessment is conducted. This process is described in HEC-20 (Lagasse et al., 2001).
- 2) A scour analysis is conducted in accordance with HEC-18 (Richardson and Davis, 2001).. This stage also involves foundation design and is most relevant to drilled shaft design. A flow chart of the scour analysis procedure is shown in Figure 13-17. For existing bridges determined to be scour critical, a new bridge design can be developed or the process can proceed to Stage 3.
- 3) A plan of action is developed to undertake bridge scour and stream instability countermeasures. This final stage does not apply to new designs and is therefore not relevant to drilled shaft design.

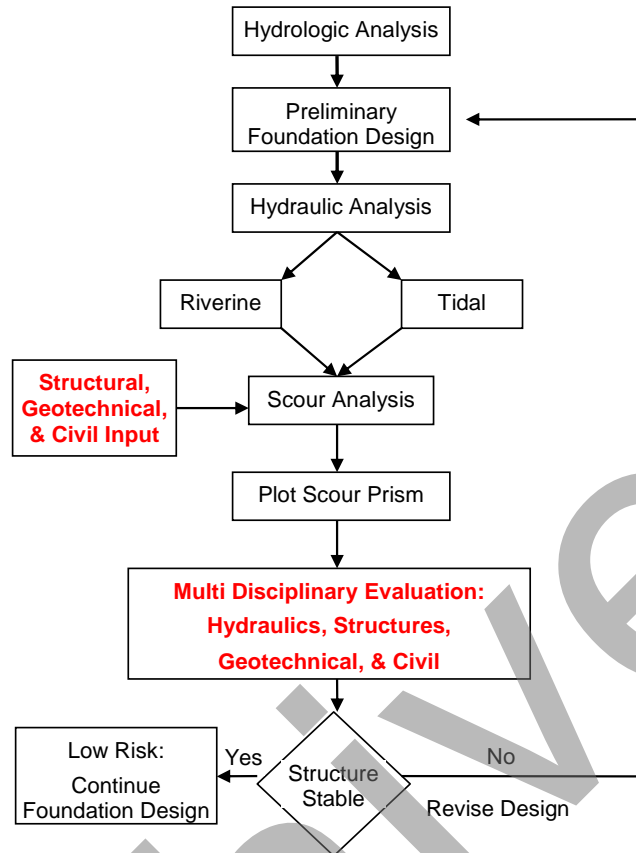


Figure 13-17 Flow Chart for Hydrology, Hydraulics, and Scour Analysis by HEC-18 (Adapted from Richardson and Davis, 2001)

Figure 13-17 also indicates the interaction that is required between hydraulic, geotechnical, structural, and civil engineers. The hydrologic and hydraulic analyses typically are conducted by a hydraulic specialist, but with structural and geotechnical input. Geotechnical information required at this stage includes subsurface profiles based on borings and geophysical tests, classification of geomaterials according to the Unified Soil Classification System, and evaluation of the erodibility of subsurface units. Soil erodibility and methods for its evaluation are covered in Section 3.2.1.3 of this manual. Structural input includes the number, location, and geometry of bridge piers and abutments. Civil engineers provide information on the station limits of the approach embankments, and the location and size of any hydraulic structures to be constructed through the embankments. Based on the scour analysis, a scour prism is developed for each pier and abutment. The design team then conducts a multidisciplinary evaluation of the bridge. Geotechnical input to this evaluation requires analysis of strength, service, and extreme event limit states of the deep foundations assuming a subsurface profile that accounts for the scour prism. If the bridge is determined to be stable, the trial design is considered low risk and is acceptable. If not, the design can be modified or measures can be taken to counter the effects of scour, such as lengthening the bridge or increasing bridge spans. Generally, the foundations are designed for the predicted scour, rather than relying on ancillary measures, such as rip-rap armour protection, to reduce or prevent scour at the foundation locations, since the long-term effectiveness of such measures is typically unreliable.

The detailed methods and equations used to determine total scour, consisting of degradation, general scour, and local scour, are given in HEC-18 and are not be repeated herein. The principal output resulting

from scour analysis, and the result that is most relevant to drilled shaft design, is the scour prism, which is a graphical representation of the total volume of material removed by scour.

### 13.5.4 Application to Drilled Shaft Design

AASHTO Specifications (2007) require evaluation of bridge foundations for two scour conditions: (1) the *design* flood scour condition is assumed for foundation strength and service limit state evaluations and (2) the *check* flood scour condition is assumed for extreme limit state evaluation. The commentary under Article 10.5.5.2.1 states:

“Scour design for the design flood must satisfy the requirement that the factored foundation resistance after scour is greater than the factored load determined with the scoured soil removed. The resistance factors will be those used in the Strength Limit State, without scour.”

Therefore, the resistance factors given in Table 13-5 are used for strength limit state analysis of foundations under scour resulting from the design flood (100-year flood as described above). Design for the check flood, an extreme event, is addressed in Chapter 15.

For each strength or service limit state evaluation, all material in the scour prism above the total scour line is assumed to be removed and unavailable for axial or lateral support. Changes in subsurface stress also occur in response to removal of soil, and these stress changes may affect foundation resistances to both axial and lateral loads. Stress changes will vary depending on whether scour occurs over a large area (degradation and general scour) or a small area (local scour).

Figure 13-8 shows a single drilled shaft at a bridge support where scour analysis produces the scour prism as indicated by the shaded area. The original, pre-scour streambed elevation is shown (elevation of point A). The streambed is lowered to the elevation of point B based on the predicted degradation plus general scour. A local scour hole is predicted around the pier. The depth of the local scour hole,  $y_s$ , is computed using methods prescribed in HEC-18. A top width value ( $w$ ) of 2.0 times the depth of local scour on each side of the pier is suggested for practical applications (Richardson and Davis, 2001).

Vertical stress at any depth along the shaft can be estimated as follows. At the top of the embedded length of the shaft (Point C) the vertical stress is equal to zero. At a depth of embedment equal to  $1.5 y_s$  or greater, assume the vertical stress is controlled by the streambed elevation B. Assume a linear variation in vertical stress over the depth  $1.5 y_s$ . In other words, the effect of local scour on stress diminishes linearly over a depth equal to 1.5 times the scour hole depth,  $y_s$ .



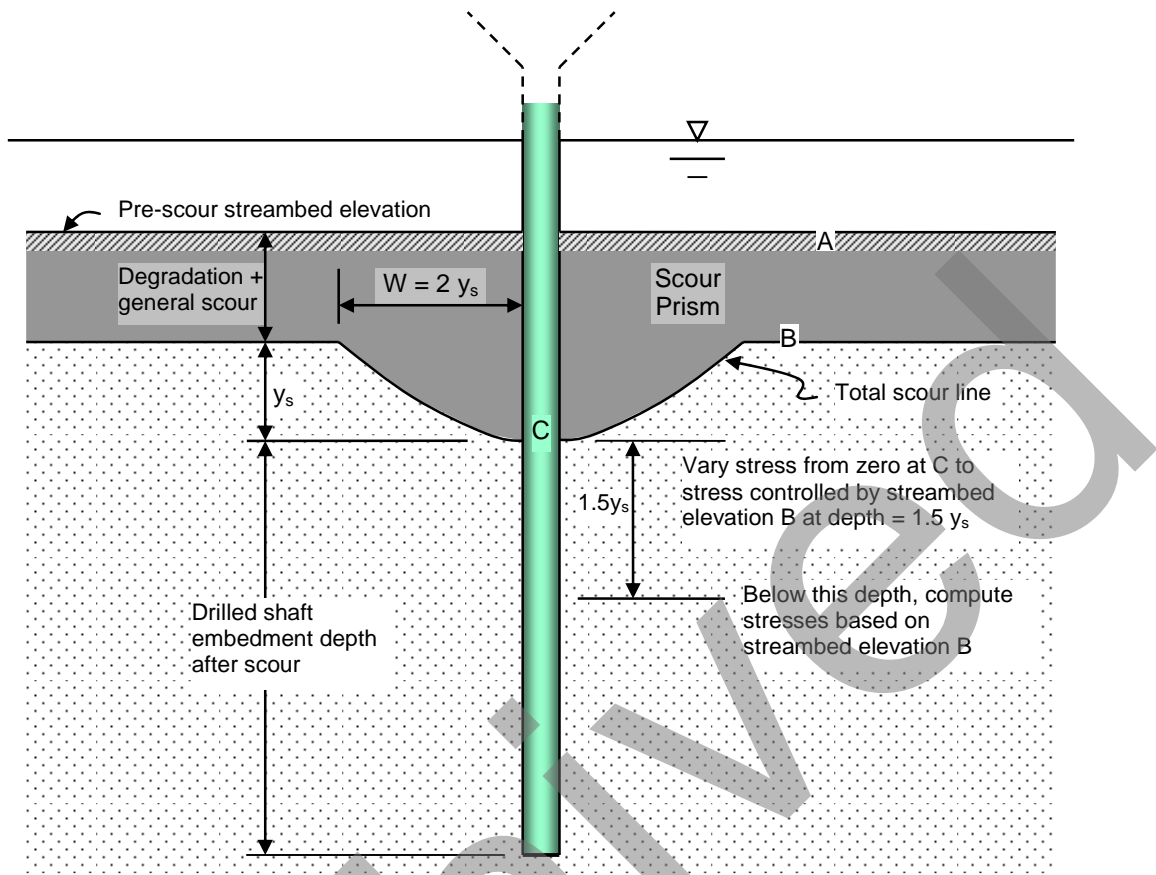


Figure 13-18 Illustration of Scour Prism and Effects on Drilled Shaft

### 13.5.5 Effects of Scour on Axial Resistance

The state of effective stress corresponding to the scour conditions, described above, can be incorporated into analysis of side resistance in cohesionless soils using the beta-method equations presented in Section 13.3.5.1. Horizontal effective stress is evaluated by considering the effects of unloading on the coefficient of horizontal soil stress,  $K$ . This requires calculation of the degree of overconsolidation resulting from scour unloading, which can be evaluated by Equation 13-9:

$$OCR = \frac{\bar{\sigma}_{v,pre-scour}}{\bar{\sigma}_{v,post-scour}} \quad 13-9$$

where:

- OCR = overconsolidation ratio due to unloading by scour
- $\bar{\sigma}_{v,pre-scour}$  = vertical effective stress based on the pre-scour streambed elevation (point A)
- $\bar{\sigma}_{v,post-scour}$  = vertical effective stress after scour, calculated as described above

The post-scour ratio of horizontal to vertical effective stress ( $K$ ) can be estimated as a function of the soil friction angle ( $\phi$ ) and OCR by Equation 13-8:

$$K = (1 - \sin \phi) \text{OCR}^{\sin \phi} \quad 13-8$$

The value of  $K$  computed in this manner is then used in Equation 13-5 to determine the nominal side resistance for cohesionless soil layers.

$$R_{SN} = \pi B \Delta z (\sigma'_v K \tan \delta) \quad 13-5$$

If a soil layer below the total scour line was overconsolidated prior to scour, to a value of OCR greater than the value calculated by Equation 13-9, the larger value of OCR should be used to calculate  $K$  for application to Equation 13-5.

Nominal side resistance in cohesive soils is normally calculated by the  $\alpha$ -method (Section 13.3.5.2). Undrained shear strength ( $s_u$ ) measured by laboratory CU triaxial tests on undisturbed samples is the recommended method for establishing design values of strength. In cohesive soils, the undrained shear strength and resulting unit side resistance can be assumed to be unchanged due to changes in effective overburden stress caused by scour. Similarly, the strength and nominal axial resistances provided by rock are assumed to be unchanged due to effects of scour.

Additional issues to be considered by foundation designers in connection with scour include:

- Drilled shaft design may require consideration of column action because of the increase in unsupported shaft length after scour.
- Local scour holes at piers and abutments may overlap one another in some instances. If local scour holes overlap, the scour is indeterminate and may be deeper. The top width of a local scour hole on each side of the pier ranges from 1.0 to 2.8 times the depth of local scour. A top width value of 2.0 times the depth of local scour on each side of a pier is suggested for practical applications.
- Placing the top of a shaft-supported footing or cap below the streambed at a depth equal to the estimated long term degradation and contraction scour depth will minimize obstruction to flood flows and resulting local scour. Even lower footing elevations may be desirable for shaft supported footings when the drilled shafts could be damaged by erosion from exposure to river or tidal currents. However, in deep water situations, it may be more cost effective to situate the pile cap at or above the mudline and design the foundation accordingly.
- Stub abutments positioned in the embankment should be founded on drilled shafts or piles extending below the elevation of the thalweg including long term degradation and contraction scour in the bridge waterway to assure structural integrity in the event the thalweg shifts and the bed material around the abutment foundations scours to the thalweg elevation. Thalweg is defined as the lowest elevation of the streambed.

## 13.6 DOWNDRAG

### 13.6.1 Occurrence

Downdrag refers to the downward-acting force transferred to a deep foundation by surrounding soil that undergoes downward vertical deformation (settlement). Load transfer is by shearing stress that develops at the soil-shaft interface. Briaud and Tucker (1997) present an overview of the downdrag problem and

note that downdrag has been reported to have caused “extreme movements, differential settlements, and extensive damage to various structures” including highway bridges.

Downdrag occurs in response to *relative* downward deformation of the surrounding soil to that of the shaft, and will not develop if downward movement of the drilled shaft in response to axial compression forces exceeds the vertical deformation of the soil. The magnitude of relative movement required to develop the full side resistance, and therefore full downdrag, is approximately 0.4 to 0.5 inches. It is prudent in making designs to assume that full downdrag will occur if any relative downward movement of the soil is anticipated.

The potential for downdrag is greatest when the soils in the upper zones of the subsurface profile can settle and where the lower portion of the shaft is founded in a relatively rigid material such as hard/dense soil or rock, as illustrated in Figure 13-19. Examples of soils that will undergo settlement after drilled shaft construction include loose sand, soft to medium stiff clay, recently-placed fill, and soils subjected to earthquake-induced liquefaction.

Settlement may occur in a sand stratum of low initial relative density in response to cyclic loading, which can be caused by an earthquake, traffic vibrations, or seasonal fluctuations in the groundwater level. The presence of a surface loading would contribute to the settlement. When a drilled shaft extends through a soft clay layer the tendency for settlement may be minimal if there is no surface loading; however, the addition of a fill such as an approach embankment or lowering of the groundwater level could induce considerable consolidation settlement that may continue long after the drilled shafts have been installed. Evidence is available to show that virtually any fill will settle to some extent with time under its own weight, particularly if it is not well compacted.

The cases described above are typical of ground conditions leading to downdrag. However, any condition that results in relative downward movement of the ground relative to the drilled shaft has the potential to cause downdrag. Briaud and Tucker (1997) suggest the following criteria for identifying when downdrag may occur. If any one of these criteria is met, downdrag should be considered in the design:

1. Total settlement of the ground surface will exceed 4 inches.
2. Settlement of the ground surface after deep foundations are installed will exceed 0.4 inch.
3. The height of the embankment to be placed on the ground surface exceeds 6 ft.
4. Thickness of the compressible soil layer exceeds 30 ft.

Bridge abutments, shown in Figure 13-20, represent a commonly encountered downdrag situation for transportation projects. A typical construction sequence consists of drilled shaft installation, construction of the abutment, and placement of fill. Settlement of the fill soil along the sides of the abutment, or along the drilled shafts if they are placed through fill, is likely. Settlement may also occur in the native soil under the load of the new fill. Consolidation of clay layers can also induce lateral loading on vertical drilled shafts because the soil may squeeze laterally toward the right in the figure.

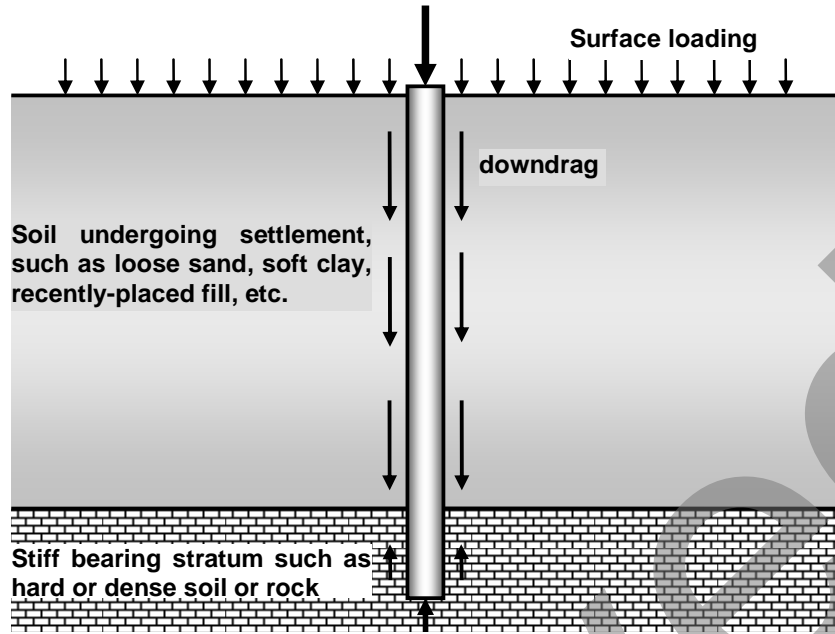


Figure 13-19 Downdrag on a Drilled Shaft Caused by Soil Settlement

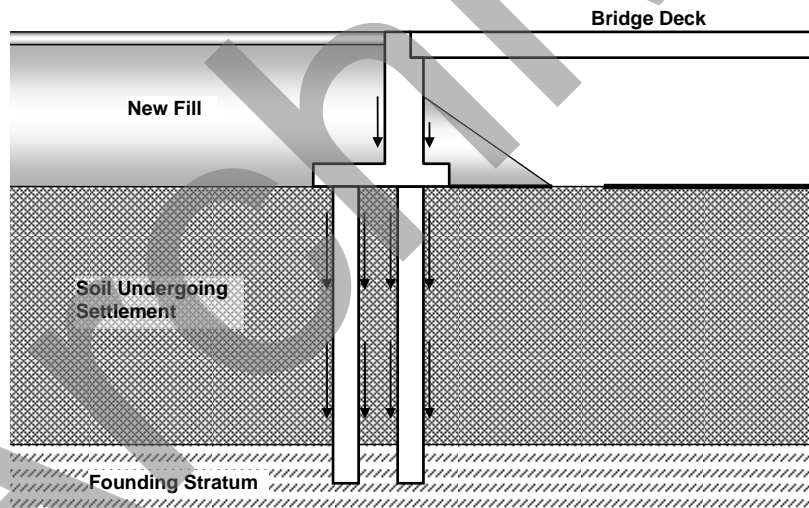


Figure 13-20 Common Sources of Downdrag at Drilled Shaft Supported Bridge Abutments

### 13.6.2 Downdrag – Basic Concepts

The response of a drilled shaft to downdrag is complex because it involves soil-structure interaction under conditions of vertically-deforming soil layers and a vertically-deforming shaft. The relative movement of the shaft to that of the soil as a function of time and depth must be known in order to evaluate correctly the magnitude of downdrag. As stated by Tomlinson (1980): "The calculation of the total negative skin friction or drag-down force on a pile is a matter of great complexity, and the time factor is of importance."

For many routine or small projects, the detailed information necessary for rigorous analyses may not be available, or the detailed analytical methods needed for proper assessment may not be warranted. Nevertheless, the downdrag problem must be recognized and dealt with, and approximate solutions based on simple concepts have been developed that can lead to useful and cost-effective designs.

A fundamental concept of deep foundation response to downdrag is the “neutral plane”, defined as the depth above which the drilled shaft is subjected to downdrag and below which the shaft develops axial resistance to the downward forces, consisting of applied compressive loads and downdrag (Fellenius, 2006). Establishment of the neutral plane is an essential step in any analytical procedure used to evaluate limit states under downdrag. For some ground conditions, the neutral plane may be a straightforward matter, for example, the case illustrated by Figure 13-16, in which the founding stratum is clearly defined as being a relatively stiff material (*e.g.*, rock) that will limit the vertical displacement of the shaft relative to the downward movement that will occur in the overlying soil. For this case, the neutral plane coincides with the contact between the compressible soil layer and the stiff founding stratum. However, the more general case involves some uncertainty in the exact location at which relative movement of the shaft to that of the soil changes the direction of side resistance from negative to positive. A simple procedure based on hand calculations is presented below to make this determination, and more rigorous analytical procedures requiring numerical analyses are briefly described and referenced.

### 13.6.3 Analysis of Downdrag

Evaluation of limit states under downdrag requires analysis to establish the depth of the neutral plane and calculation of downdrag forces transferred above the neutral plane. If there is a well-defined depth corresponding to a contact between a weak or soft overlying soil that will settle and an underlying strong layer that will resist deformation, it may be satisfactory to assume the neutral plane to be at the surface of the strong layer. The downdrag load can be computed by integrating the maximum load transfer based on the shear strength of the soil obtained from either total or effective stress calculations. The maximum load along the shaft would occur at the top of the strong layer and would be the sum of the downdrag force and the compressive force transmitted at the top of the drilled shaft. Structurally, the shaft would need to be designed for that load.

A more general analysis accounts for the downward shaft displacement needed to mobilize side and base resistances, thus causing the neutral plane to move upward into the settling soil layer. The basic concept is illustrated in Figure 13-21. A drilled shaft extends through one or more strata of soil expected to undergo settlement, and into underlying soil layers not expected to undergo settlement (Figure 13-21a). Load transfer curves, in terms of unit side or base resistance versus relative movement between the shaft and geomaterial, are assumed. A simple hand solution is possible if the side load-transfer curves are assumed to be fully plastic, as shown in Figure 13-21b. Elastic-plastic or nonlinear load-transfer curves can be used, but a numerical solution by computer is then necessary using the methods described in Appendix D (the  $t$ - $z$  curve method). The load transfer curve for base resistance is assumed to be linear, *i.e.*, a simple spring.

The relative movement of the drilled shaft with respect to the soil is first assumed to be as shown in Figure 13-21c, with the neutral plane selected at the contact between the upper compressible soil and the underlying non-settling strata. A negative sign indicates the soil is moving downward with respect to the drilled shaft (downdrag) and a positive sign indicates the drilled shaft is moving downward with respect to the soil (load transfer from the shaft to the soil). With these assumptions, the distribution of load along the drilled shaft is as shown in Figure 13-21d. It follows that the maximum load in the drilled shaft occurs at the contact between the settling and non-settling strata (the assumed neutral point). Considering, however, that downward displacement of the shaft is necessary to mobilize the base

resistance, and that the shaft undergoes elastic shortening, the neutral point cannot occur at the interface between the layers but must move upward, as shown in Figure 13-21e. A revised distribution of load along the drilled shaft is shown in Figure 13-21f.

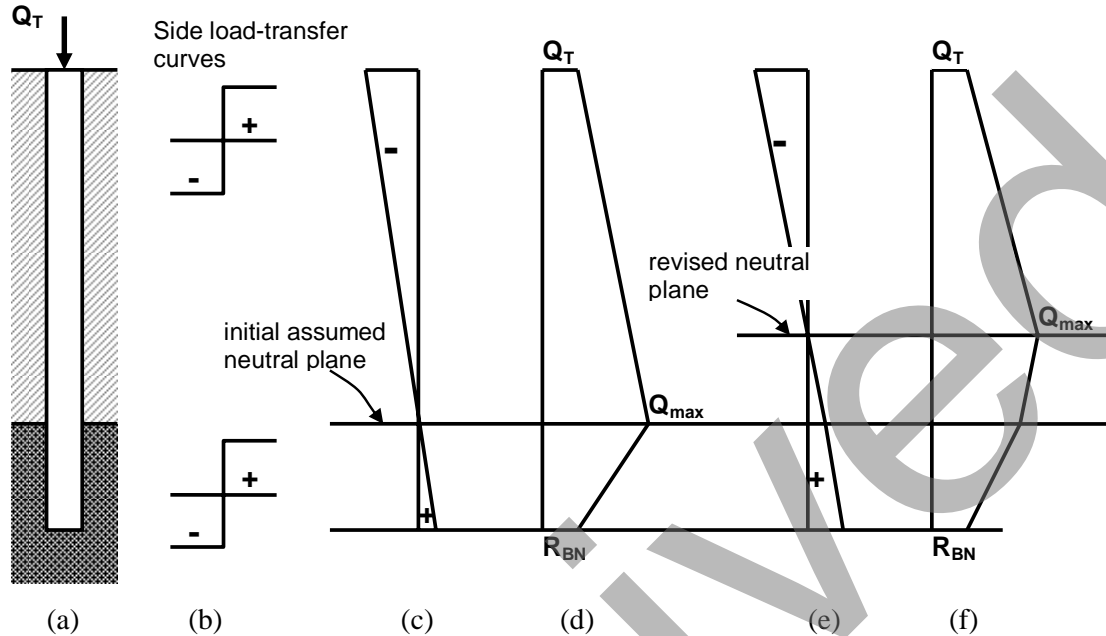


Figure 13-21 Mechanics of Downdrag. (a) example problem; (b) load transfer curves; (c) relative movement of drilled shaft with respect to geomaterial (neutral point assumed at bottom of settling stratum); (d) distribution of load along drilled shaft; (e) revised estimate of relative movement of drilled shaft with respect to geomaterial; (f) revised estimate of distribution of load along drilled shaft

Based on the mechanics described above, the following iterative procedure can be used to approximate the position of the neutral surface.

1. From the geomaterial profile, estimate as accurately as possible the magnitude of the downward movement of the settling soil. The downward movement is needed as a function of depth through the stratum. Detailed procedures for analyzing the settlement behavior of approach fills for bridges are presented in Chapter 7 of the FHWA Manual on Soils and Foundations (Samtani and Nowatzki, 2006). For time-dependent settlement (consolidation) assume end of consolidation settlement. Also assume that settlement varies linearly with depth from a maximum value at the ground surface to zero at the interface between the compressible (settling) soil layer and the underlying dense or stiff layer.
2. Establish the geometry of the drilled shaft (trial design) and its corresponding axial stiffness (AE).
3. Select load transfer curves for all of the layers the drilled shaft will penetrate. If a linear curve is selected for load transfer in base resistance and fully plastic curves are selected for load transfer in side resistance, a hand solution can be made without difficulty. Alternatively, the numerical modeling procedure described in Appendix D can be adopted ( $t$ - $z$  curve method), in which case nonlinear curves can be used, but a numerical computer solution is required.
4. Select a value of base settlement ( $w_b$ ) and calculate the distribution of load along the drilled shaft. This involves calculation of nominal side and base resistances ( $R_{SN}$  and  $R_{BN}$ ) that develop below the

assumed neutral plane and corresponding to the selected value of  $w_b$ , and the downdrag load ( $Q_D$ ) assumed to be transferred above the assumed neutral plane. Calculate the nominal head load ( $Q_T$ ) as the difference between the nominal resistance (side and base) and downdrag loads, as follows:

$$Q_T = R_{SN} + R_{BN} - Q_D \quad 13-31$$

The maximum load ( $Q_{max}$ ) is the sum of the head load and downdrag load and occurs at the neutral plane as shown in Figure 13-21d, or:

$$Q_{max} = Q_T + Q_D \quad 13-32$$

5. Calculate the displacement of the shaft ( $w_n$ ) at the elevation of the assumed neutral plane as the sum of the base displacement and the elastic compression of the shaft, by:

$$w_n = w_b + \frac{(Q_{max} + R_{BN}) \times L_{socket}}{2AE} \quad 13-33$$

in which  $L_{socket}$  = length of shaft embedment below the assumed neutral plane. Note that in Equation 13-33, the term  $(Q_{max} + R_{BN})/2$  represents the average compressive force acting in the shaft below the neutral plane.

6. Determine the distance of the new neutral plane above the assumed neutral plane. If the compressible layer is homogeneous and the settlement can be assumed to vary linearly (as described in Step 1), the following approximation can be made:

$$z_n = \frac{w_n}{\frac{w_{ground}}{\Delta z_s}} \quad 13-34$$

in which  $z_n$  = distance of new neutral plane above its assumed initial position,  $w_n$  = settlement of the drilled shaft at the elevation of the neutral plane by Equation 13-34 (sum of base displacement and elastic shortening),  $w_{ground}$  = settlement of the ground surface, and  $\Delta z_s$  = thickness of the compressible soil layer. If the compressing soil is not homogeneous and settlement is non-uniform, more rigorous methods may be required (described below).

7. Using the new neutral plane, re-calculate the distribution of load on the shaft (Step 4), settlement of the shaft at the neutral plane (Step 5), and the new location of the neutral plane (Step 6). Repeat Steps 4-6 until reasonable convergence is achieved, typically in 2 to 3 iterations.

Convergence can be achieved after only a few trials if the shaft is elastic and if the load transfer functions are simple. If the shaft moves down a sufficient amount, downdrag may disappear completely. However, downward displacement of the shaft must be within the serviceability limit state criterion.

A hand solution using the procedure outlined above, based on fully-plastic side load-transfer curves, provides a practical, conservative analysis of the downdrag problem and may be sufficient in many cases. A computer program is also available for performing the downdrag calculations. The program, PILENEG, was developed in coordination with the NCHRP report by Briaud and Tucker (1997) and is

available from: <http://ceprofs.tamu.edu/briaud>. A more precise solution can be obtained using numerical solutions with nonlinear  $t$ - $z$  curves. However, caution is advised. The accuracy of the solution is not guaranteed to be any better because of the uncertainties involved in estimating settlement of the compressible soil layers as well as uncertainties associated with the assumed  $t$ - $z$  curves. The computer solution may be applied to best advantage by performing parametric studies that enable the designer to develop an improved understanding of the important elements of the downdrag problem. Furthermore, guidance can be obtained from field observations that may be useful in performing updated estimates of settlement and downdrag loading for a particular foundation.

### 13.6.4 Downdrag Forces

In the analysis outlined above, the designer must select values of shearing stress imposed by the settling soil layers, referred to herein as nominal unit downdrag,  $f_{ND}$ . The methods described in Section 13.3.5 for calculating nominal unit side resistances are applicable to the downdrag problem and are recommended. These include the  $\beta$ -method for cohesionless soils, the  $\alpha$ -method for short-term undrained conditions in cohesive soils, and effective stress analysis for long-term conditions in cohesive soils.

Some mechanisms responsible for soil settlement, such as densification of granular soils and consolidation of cohesive soils, also result in increases in soil shear strength. Prediction of the soil shear strength properties under conditions that will exist *after* settlement is needed in order to evaluate the maximum downdrag forces. For total stress analysis in cohesive soils, the  $\alpha$ -method, based on undrained shear strength, can be used to determine nominal unit downdrag (see Section 13.3.5.2). A rational approach is to conduct consolidated-undrained (CU) triaxial compression tests on representative samples of the cohesive soil. Consolidation pressures should correspond to vertical effective stresses to which the cohesive soil will be consolidated under field conditions. Since this stress will vary with depth in the soil profile, it will be necessary to conduct multiple tests over the range of expected stresses and to apply the corresponding measured undrained shear strength over the corresponding depth along the shaft to evaluate downdrag. O'Neill and Reese (1999) recommend using a value of  $\alpha = 1.0$ , based on the assumption that consolidation of the cohesive soil will negate the effects of disturbance and remolding caused by construction.

Fundamentally, the nominal unit downdrag transmitted to a shaft by cohesive soil at end-of-consolidation settlement is related to the fully-drained shear strength, rather than the undrained shear strength. Using effective stress analysis, the nominal unit downdrag is given by:

$$f_{ND} = a' + K \sigma'_v \tan \delta' \quad 13-35$$

where:

- $f_{ND}$  = nominal unit downdrag,
- $a'$  = effective stress adhesion,
- $K$  = coefficient of horizontal soil stress,
- $\sigma'_v$  = vertical effective stress, and
- $\delta'$  = effective stress friction angle for the soil-shaft interface.

Values of the effective stress cohesion ( $c'$ ) and friction angle ( $\phi'$ ) are measured in laboratory triaxial tests, either consolidated-drained (CD) or consolidated-undrained (CU) with porewater pressure measurements. The effective stress adhesion can be taken equal to  $c'$  and the interface friction angle can be taken equal to



$\phi'$ . The value of  $K$  can be taken equal to the in-situ value,  $K_o$ , which must be evaluated in terms of the soil overconsolidation ratio (see Equation 3-15).

Downdrag forces on drilled shaft groups are considered in Chapter 14.

### 13.6.5 Evaluation of Limit States Under Downdrag

For evaluation of all strength limit states, current AASHTO LRFD specifications (2007) include the downdrag force (DD) as a component of the permanent load with a load factor of  $\gamma = 0.35$  (minimum) and  $\gamma = 1.25$  (maximum). Commentary in AASHTO (2007), Section C.3.11.8, states that the maximum load factor is used when investigating maximum downward forces, and the minimum load factor is utilized when investigating possible uplift loads.

Following the approach outlined in AASHTO (2007), the factored downdrag force, acting in combination with the other factored axial force effects at the head of the shaft, is included in the evaluation of each strength limit state for which the bridge is designed. For compression, the positive (upward-directed) side and base resistances developed below the neutral plane are factored using the resistance factors presented in Table 10-5. Each strength limit state is then evaluated according to the basic LRFD equation (Equation 13-1), which takes the following form:

$$\sum \eta_i \gamma_i F_i + \gamma_p (DD) \leq \sum_{i=1}^n \phi_{S,i} R_{SN,i} + \phi_B R_{BN} \quad 13-38$$

in which the first term on the left equals the summation of factored axial force effects obtained from structural modeling of the bridge or other structure. In the second term,  $\gamma_p$  = load factor for downdrag (= 1.25 for compression) and DD = downdrag force. Resistances on the right include the summation of factored side resistances for the layers below the neutral plane plus factored base resistance. Both geotechnical and structural strength limits are to be checked for each applicable strength limit state.

The response of a drilled shaft to downdrag in combination with the other forces acting at the head of the shaft is complex, and a realistic evaluation of actual limit states that may occur requires careful consideration of two issues: (1) drilled shaft load-settlement behavior, and (2) the time period over which downdrag occurs relative to the time period over which non-permanent components of load occur. When these factors are taken into account, it may be appropriate to consider different downdrag forces for evaluation of geotechnical strength limit states than for structural strength limit states. Issue number (2) above leads to the conclusion that the load combinations for geotechnical strength limit states should generally be limited to permanent load only, for cases involving downdrag. These issues are addressed in the following paragraphs.

The *geotechnical* strength limit state of a drilled shaft loaded in compression and with its base bearing in soil is defined at a downward displacement of approximately 4% of the shaft diameter (see Figure 13-10). A rational approach to evaluating this strength limit state will incorporate the force effects occurring at this magnitude of downward displacement. This will include the factored axial force effects transmitted to the head of the shaft, plus the downdrag forces occurring at a downward displacement equal to 4% of the shaft diameter. In many cases, this amount of downward displacement will reduce or eliminate downdrag. For soil layers that undergo settlement exceeding 4% of the shaft diameter, downdrag forces are likely to remain and should be included, with a load factor of 1.25. This approach requires the

designer to predict the magnitude of downdrag force occurring at a specified downward displacement. This can be accomplished using the simple hand calculation procedure described above in Section 13.6.3, or several software tools identified at the end of this section.

Additionally, components of load that exist over time periods which are short, relative to the time period over which downdrag forces develop, can be neglected for the purpose of evaluating geotechnical strength limit states which include downdrag. The rationale behind this recommendation is that force effects associated with downdrag develop over a relatively long period of time, on the order of months to years. Non-permanent loads, such as live load, temperature changes, etc., occur over periods of hours or possibly days. Axial force effects caused by non-permanent loads that result in downward movement of the drilled shaft will eliminate downdrag over the period of their application. Even when downdrag is caused by a large magnitude of settlement, but occurs over a long time period of time, the downdrag force can be completely reversed by a relatively small magnitude of downward displacement in response to short-term loading. This leads to the following recommendations:

- when downdrag forces are determined to exist at a downward displacement of 4% of the shaft diameter, evaluation of drilled shafts for the geotechnical strength limit state in compression should be conducted under a load combination that is limited to permanent loads only, including the calculated downdrag force (DD) at a settlement equal to 4% of the shaft diameter. This applies to all of the AASHTO strength limit states listed in Table 10-2. This case is likely to occur when the soil layers causing downdrag undergo relatively large magnitudes of settlement (i.e., greater than 4% of the shaft diameter).
- when analysis of a shaft subjected to downdrag shows that the downdrag force would be eliminated in order to achieve a downward displacement of 4% of the shaft diameter, evaluation of geotechnical strength limit states in compression should be conducted under the full load combination corresponding to the relevant strength limit state, including the non-permanent components of load, but not including downdrag.

The *structural* strength limit state under downdrag should be considered carefully for a drilled shaft with its tip bearing in stiff material, such as rock or hard soil, which would be expected to limit settlement to very small values. This corresponds to the condition illustrated in Figure 13-19. In this case, the full downdrag force could occur in combination with the other axial force effects, because downdrag will not be reduced if there is little or no downward movement of the shaft. Therefore, the factored force effects resulting from all load components, including full downdrag with the maximum load factor of 1.25, should be used to check the structural strength limit state of the drilled shaft. The maximum axial force effect in the shaft occurs at the neutral plane, as shown in Figure 13-21e.

It was noted in Section 10.4 that the most common strength limit states applicable to the design of drilled shafts are Strength I and Strength IV. The Strength IV load combination is for high ratio of dead load to live load and is often evaluated in the design of long-span bridges. This load combination is of particular interest when downdrag forces exist. Examination of Tables 10-3 and 10-4 (AASHTO Load Combinations and Load Factors) shows that for Strength IV, the permanent load factor ( $\gamma_p$ ) applied to bridge components and attachments (DC) is 1.5, compared to 1.25 for the other strength limit states. When the factored downdrag force, at settlement of 4% of shaft diameter, is combined with the higher factored force effects associated with Strength IV, this could be a critical load combination for evaluating the geotechnical strength limit state of drilled shafts. Similarly, for shafts bearing in rock that will limit settlement, the full factored downdrag combined with the factored permanent load force effects of the Strength IV load combination could be a critical case for evaluating the structural strength limit state of the drilled shafts.

Downdrag is also included in the load combination for Service I limit state. In most cases involving large downdrag forces acting on shafts bearing in soil, settlement, not strength, will be the critical design consideration. Settlement analysis of drilled shafts under downdrag forces can be performed by several different methods. A simple first-order approximation can be made as described above in connection with estimating the position of the neutral surface, by Equation 13-33. More rigorous methods include the computer program cited above by Briaud and Tucker (1997) and available from: <http://ceprofs.tamu.edu/briaud>; software based on the analysis methods of Fellenius (2006) and available from UniSoft, Ltd. at: <http://www.unisoftltd.com/>; or numerical solutions using the t-z curve method (Appendix D). A load factor value of 1.0 is applied to the downdrag force for Service I limit state evaluation.

A downdrag force induced by settlement of sandy soil layers following liquefaction during earthquakes is to be applied to drilled shafts in combination with the force effects resulting from Extreme Event I load combination (earthquake). This case is addressed in Chapter 15. In accordance with Section 3.11.8 of AASHTO (2007), liquefaction-induced downdrag is not to be combined with downdrag induced by consolidation settlement.

### 13.6.6 Strategies to Address Downdrag

To address the potentially negative impacts of downdrag, the capacity of the drilled shafts can be increased by increasing the diameter, length, or number of shafts. Alternatively, measures can be taken to reduce downdrag. Some of the measures identified by Briaud and Tucker (1997) for driven piles are applicable to drilled shafts, including:

- Preloading of the soil to induce settlement of the ground prior to drilled shaft construction, thereby reducing settlement that will take place after drilled shaft construction. Procedures for designing a preload program are given by Samtani and Nowatzki (2006). Wick drains are often used in conjunction with preloading in order to shorten the time required for consolidation. Additional information on wick drains is available in "Prefabricated Vertical Drains" (Rixner et al., 1986) and in "Ground Improvement Methods" (Elias et al., 2004).
- Use of lightweight materials as structural fill in place of conventional fill to reduce surface loading and thereby minimize settlement of compressible soil layers. Effective materials for this application include geofoam, foamed concrete, wood chips, blast furnace slag, and expanded shales. Additional information on lightweight fills is available in Elias et al. (2004).
- Use of permanent steel casing, with or without surface coating, to reduce soil adhesion within the zone of downdrag.
- Prevent direct contact between the drilled shaft and compressible soils expected to cause downdrag. This approach may be limited to cases in which lateral loading is not significant. Load transfer through side shear can be eliminated or minimized by using permanent double casing in the upper portions of the shaft and filling the annular space between the casings with a material that essentially eliminates shear load transfer, such as styrofoam beads.

For an individual case, both approaches (change the drilled shaft design versus the application of measures to reduce settlement) should be considered and the solution selected on the basis of cost, constructability, and other project requirements.

## 13.7 DESIGN FOR EFFECTS OF EXPANSIVE SOIL

This section addresses uplift of drilled shafts caused by the swelling of expansive soil or rock. Expansive geomaterials are those that exhibit large volume increases in response to the addition of water. Fine-grained soils containing the smectite clay minerals (*e.g.*, montmorillonite) or very heavily-overconsolidated fine-grained soils at low in-situ moisture content are most likely to exhibit expansive behavior. Drilled shafts may be installed under conditions of low moisture content. If additional moisture becomes available during or subsequent to construction, swelling can generate significant stress increases at the soil-shaft interface. The resulting shear stress acts upward on the drilled shaft. Fine-grained sedimentary rocks composed of expansive clay minerals (clay-shales, compaction shales) may cause similar effects, as well as rocks composed of crystalline hydrates such as gypsum.

### 13.7.1 Occurrence and Identification of Expansive Soils

Soils and rock exhibiting expansive behavior are common throughout much of the United States. Locations where expansive geomaterials are most prevalent include (1) Texas and along the Gulf Coast States, (2) the Appalachian states, (3) the Southwest, and (4) the Great Plains (Krohn and Slosson, 1980). Peck, et al. (1974) report that swelling soils are "especially prevalent in a belt extending from Texas northward through Oklahoma, into the upper Missouri valley, and on through the western prairie provinces of Canada. In many parts of this belt, considerations of swelling dominate the design of foundations of structures." There are probably about twenty States in the United States where expansive clays present a problem to some degree (Gromko, 1974).

The design of drilled shafts in expansive soils requires special care to ensure there are no undesirable movements of the foundation. The first step is to determine whether the soil in the design zone is expansive. A number of techniques are useful for identifying potentially expansive geomaterials, including:

- Observation of existing structures near the site,
- Identification of the clay minerals in the geomaterial (smectites, particularly those with sodium as the predominant exchangeable cation, are especially prone to swelling)
- Performance of swell pressure or volume-change tests (swell tests) using undisturbed specimens recovered from the site, and
- Use of published correlations with index properties of the soil.

Snethen et al. (1977) conducted a study for the U.S. Army Corps of Engineers in which methods based on the use of index properties were evaluated. The classification method resulting from this study is termed the "WES (Waterways Experiment Station) Classification Method" and is summarized in Table 13-4. The variable  $\tau_{nat}$  in Table 13-4 refers to the in-situ total soil suction, which can be measured using the filter paper suction test as prescribed in ASTM D 5298 (ASTM, 1996). Potential swell can also be determined by a laboratory oedometer test (ASTM D 4546). In this procedure, an undisturbed specimen at its in-situ water content is placed in the oedometer and subjected to a load corresponding to the in-situ overburden stress, followed by inundation and measurement of swell, followed by incremental loading to compress the specimen approximately back to its original volume.

At sites where geomaterials near the surface are classified as having a "high" swell potential, according to Table 13-4, drilled shafts should be designed explicitly considering the forces exerted on the drilled shaft by the expansive geomaterials. At sites with geomaterials having a "low" swell potential, explicit

consideration of the effects of the expansive soil is not usually necessary because the design requirements for reinforcing and for shaft penetration derived from compression or uplift loading from the structure are usually sufficient to overcome any effects of expansive soils. In "marginal" geomaterials, the designer should rely on local history of the performance of bridges and buildings in order to decide whether to consider effects of expansive geomaterials explicitly.

**TABLE 13-4 METHOD OF IDENTIFYING POTENTIALLY EXPANSIVE SOILS  
(SNETHER, ET AL., 1977)**

Liquid Limit (%)	Plasticity Index	$\tau_{nat}$ (tsf)	Potential Swell (%) <sup>a</sup>	Potential Swell Classification
< 50	< 25	< 1.5	< 0.5	low
50 – 60	25 - 35	1.5 – 4.0	0.5 – 1.5	marginal
> 60	> 35	> 4.0	> 1.5	high

<sup>a</sup> vertical swell of a confined sample with vertical pressure equal to overburden pressure, expressed as a percentage of specimen original height

### 13.7.2 Estimating the Zone of Seasonal Moisture Change

It is usually assumed that swelling only occurs down to the depth at which seasonal moisture change occurs, although there can be exceptions to that situation. Therefore, a critical step in the analysis of a drilled shaft subjected to uplift from expansive geomaterial is the determination of the thickness of the stratum that will swell or, in other terms, the depth below which there is no seasonal change in moisture content. No definitive method exists for establishing the zone of seasonal moisture change. However, Stroman (1986), as reported in O'Neill and Reese (1999), reports the following useful procedure. Core samples from a soil boring are examined to determine the depth to which the soil is jointed, perhaps slickensided, and blocky in structure. There may also be a change in color that is evident at the bottom of the zone of seasonal moisture change. The soil has probably been dried and subsequently wetted in that zone. Stroman further noted that useful information on the penetration of wetting and drying could be obtained by making extremely careful determinations of moisture content and by plotting these values as a function of depth. The water contents will frequently reflect a more erratic nature in the zone of seasonal moisture-content change. O'Neill and Poormoayed (1980) also describe a method wherein liquidity indexes obtained from samples recovered over two or more seasons are plotted versus depth. The liquidity index will be rather scattered in the zone of seasonal moisture change but will approach a constant value within the zone of stable moisture.

In some profiles the surface zone of seasonal moisture change may overlie a stable but moisture deficient clay or clay-shale. This type of profile is illustrated in Figure 13-22. The stable but moisture-deficient zone is sufficiently deep to be beyond the influence of seasonal rains, high temperatures, and similar effects. However, installation of a drilled shaft through the lower moisture-deficient geomaterial may provide a conduit for moisture from the surface directly into the moisture-deficient zone, which may then swell. Drilled shafts that have poor contact between the sides and the surrounding geomaterial (*e.g.* shafts constructed with temporary casing and low-slump concrete) are especially vulnerable to this process. Johnson and Stroman (1984) describe a case where long-term swelling in a situation such as this apparently severed a reinforced drilled shaft in tension more than 30 ft below the ground surface.

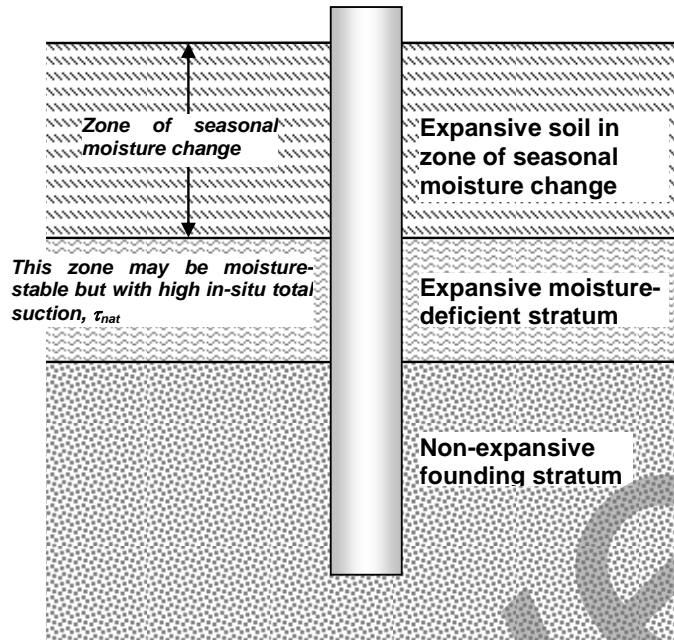


Figure 13-22 Idealized Example of a Drilled Shaft in Expansive Ground

### 13.7.3 Design Solutions

A conservative approach is strongly advised when designing drilled shafts in expansive geomaterials. The concept is similar to that used in designing drilled shafts for downdrag except that the shearing forces on the sides of a drilled shaft above the depth of seasonal moisture change (or the depth to which swelling is judged to occur) are directed upward and, if those shearing loads exceed the applied compressive load, the shearing resistances in the stratum below the expansive soil are directed downwards. The neutral point is assumed to be at the bottom of the zone of expansion.

The following general steps are recommended in making a design of a drilled shaft in expansive soil or rock:

1. Identify the expansive geomaterial The method presented in Table 13-4 is recommended for routine design. It is possible that a relatively accurate identification can be made from a field reconnaissance and from liquid limit and plasticity index. If there is any doubt about the potential swell of the soils at the site, it will be advisable to perform soil suction tests and swell tests in the oedometer on undisturbed specimens obtained from representative borings using methods described in Chapter 2. It is important to perform such tests under the driest moisture conditions that are expected during the construction season since total suction ( $\tau_{nat}$ ) can change considerably from season to season, and total suction largely determines how much swell will occur.

2. Estimate the depth of the expansive zone. The thickness of the expansive zone near the surface can be found approximately by use of the techniques given previously. The soil profile may be such that the depth of the expansive zone is evident and the founding stratum below that zone is non-expansive. On the other hand, as illustrated in the soil profile shown in Figure 13-22, expansive, moisture-deficient soil or rock may exist below the zone of seasonal moisture change. A prudent design for a ground profile similar to that illustrated in Figure 13-22 would be based on the assumption that all of the geomaterials identified as having a “high” swell potential will exert uplift on the drilled shaft. However, this approach

may be overly conservative in many cases, especially where potentially expansive soils extend well below the estimated actual zone of expansion, as determined by seasonal moisture change or limited to the maximum swell pressure.

3. Estimate the amount of swell (optional) Several procedures have been proposed for estimating the magnitude of swell for a specific soil profile (see Wray 1997). Because of the large number of factors that affect the prediction and because of the complex nature of the problem, the amount of swell can be predicted only within broad limits. For design of drilled shafts, detailed analysis of the magnitude of swell as a function of depth is not normally warranted nor is it necessary. The approach recommended herein is to identify soil layers having “high” swell potential and then design the shaft assuming that swell-induced uplift loading will occur in those layers. If a more detailed analysis of swell is deemed necessary, the reader is referred to the above reference or Fredlund and Rahardjo (1993).

4. Estimate the uplift force The uplift force is limited by the maximum unit shearing stress that can be transferred at the soil-shaft interface. The limiting shear stress can be evaluated on the basis of total stress using the  $\alpha$ -method as presented in Section 13.3.5.2. A reasonable procedure is to assume that the full undrained shear strength ( $s_u$ ) of the expansive soil will act in uplift on the drilled shaft. This corresponds to application of the  $\alpha$ -method with  $\alpha = 1.0$ . The undrained shear strength should be evaluated at the water content of the soil or rock after it absorbs all the water possible under the overburden pressure corresponding to the depth below finished grade.

In theory, effective stress methods can also be applied to analyze uplift forces. This requires accurate knowledge of the state of effective stress at the soil-shaft interface under conditions of swell and of the effective stress strength properties for the unsaturated soil. Methods for laboratory measurement of strength properties of unsaturated soils are given by Fredlund (1997), but are not considered routine for evaluating foundation side resistance as there are no data to validate this approach for predicting uplift forces on drilled shafts caused by expansive soils.

5. Execute the design Three possible procedures that can be employed are presented below for the design of a drilled shaft in expansive soil. Procedures A and B employ methods to eliminate or at least minimize the transfer of uplift forces from the expansive material to the drilled shaft. The approach employed in Procedure C is to design the shaft structurally and geotechnically to withstand the tensile forces induced by uplift caused by swelling soil.

Procedure A This procedure is based on isolating the drilled shaft from the expansive geomaterial by the use of a permanent casing. An oversized hole is excavated to the top of the founding stratum (to a point below the expansive soil), a permanent casing is placed, and then the drilled shaft is installed up to the level of the bottom of this casing. A second casing of smaller diameter is then set inside of the outer casing and the remainder of the shaft is concreted inside the inner casing. The inner casing, which serves as a form, can be made of a lightweight material such as a corrugated steel tube. Sometimes it is removed after the concrete has set. Ordinarily, this procedure works best where the outside casing can be placed down into inert soil (such as sand) or rock so that any water that enters the annular space between the inner and outer casings is not exposed to potentially expansive geomaterials (such as clay). No special calculations are necessary except to compute the resistance and deformation of the drilled shaft below the outside casing in relation to the appropriate structural load combinations and insuring that the penetration and diameter are adequate.

Kim and O'Neill (1996) describe long-term field experiments in which two concentric lengths of pressed-fiber tubing separated by layers of asphalts of varying consistencies were used to isolate surficial expansive soil from drilled shafts. This process can be used where clay exists below the permanent casing by placing the concentric casing to a close tolerance against the expansive soil, or backfill can be placed outside of the outside tube if necessary, and its use obviates the need for temporary casing. Although the

expansive soil contacts the outside of the casing and the concrete is formed against the inside, the method was found to reduce uplift forces by up to 90 per cent when compared to the forces generated against a shaft that was not protected from the expansive clays in this way. This behavior was a result of the low shear strength of the asphalt inserts when sheared relatively slowly.

**Procedure B** Raba (1977) and his associates in San Antonio, Texas, have successfully used the procedure shown in Figure 13-23. The excavation is made to the full depth into rock or other stable bearing stratum. Concrete is poured to the top of the bearing stratum, Point A in Figure 13-23. A structural shape, such as a steel H-pile, is embedded into the fresh concrete so that the top of the steel section extends above the ground surface. This becomes the point of attachment of the drilled shaft to the superstructure. The space around the steel member within the expansive zone is filled with weak concrete to complete the foundation. The portion of the steel member that extends through the expansive zone can be coated with an asphaltic layer, if desired, to ensure that minimal uplift forces are transmitted through the weak concrete. The weak concrete cracks when uplift forces generated by expansive soil occur, eliminating the transfer of significant shearing loads to the steel section if asphaltic layers are applied. The process of properly applying asphaltic layers can be tricky, especially in hot weather, so the design of the asphalts and handling methods should be done by experts.

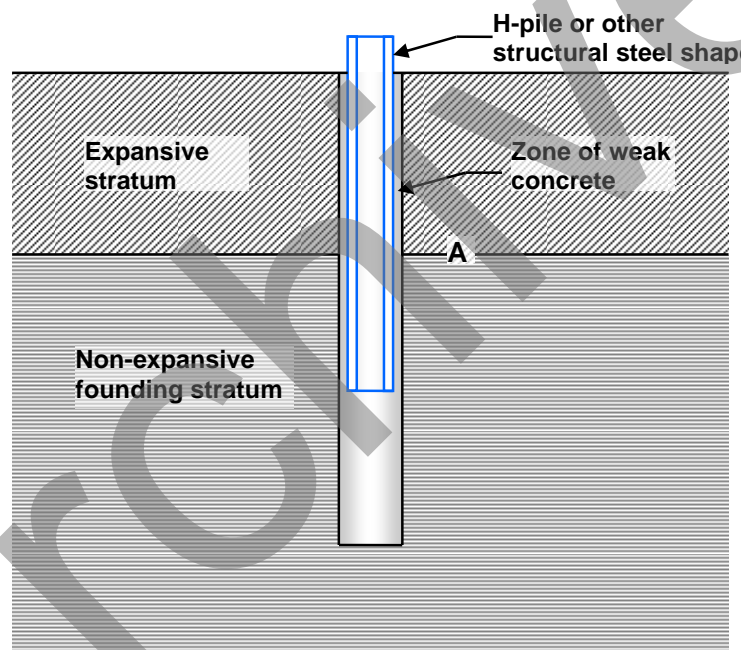


Figure 13-23 Use of Embedded Structural Shape with Weak Concrete, Procedure B

**Procedure C.** The most frequently used approach is to design each drilled shaft to withstand the uplift forces expected to be imposed by the expansive materials, as illustrated in Figure 13-24. For evaluation of limit states, the uplift forces are treated as a load. The uplift force ( $Q_{UN}$ ) and axial load transmitted to the top of the shaft ( $Q_{TN}$ ) must be resisted by the side resistance provided by embedment into the non-expansive founding strata ( $R_{SN}$ ). Structurally, the steel reinforcing is designed to withstand the maximum expected tensile force, assumed to occur at the elevation of Point A (the assumed neutral point, which is located at the base of the zone of expansive geomaterial). The LRFD equations to be evaluated are summarized as follows.



The general form of the LRFD equation is given by:

$$\sum \eta_i \gamma_i F_i \leq \sum \phi_i R_i \quad 13-1$$

where the term on the left side represents the summation of factored loads and the term on the right side represents the summation of factored resistances.

The summation of factored uplift resistances for evaluation of LRFD limit states is as given previously (Section 13.4):

$$\sum \phi_i R_i = \sum_{i=1}^n \phi_{S,i} R_{SN,i} \quad 13-30$$

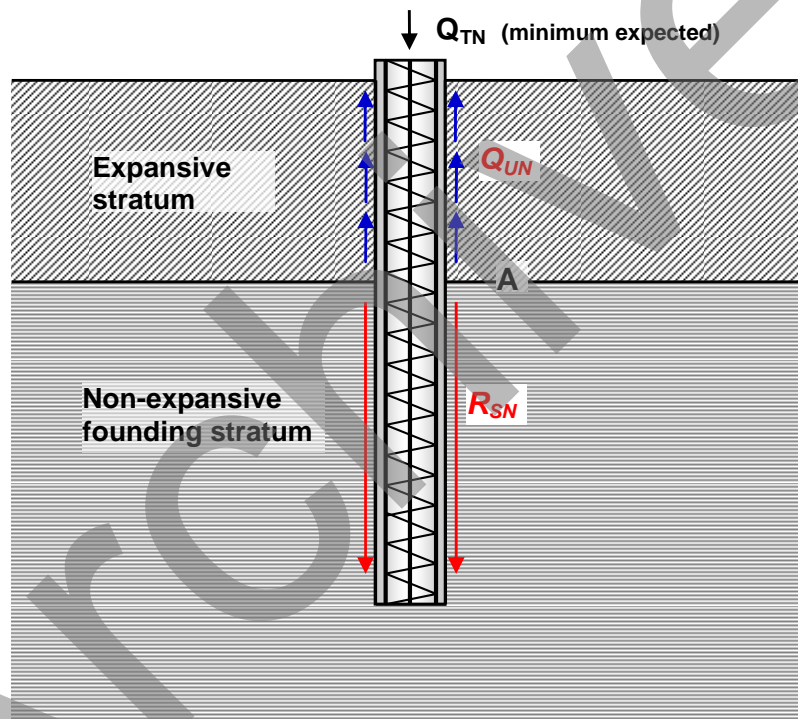


Figure 13-24 Axial Force Effects and Resistances for Design of Drilled Shafts by Procedure C

where:

- $R_{SN,i}$  = nominal side resistance for layer  $i$ ,
- $\phi_{S,i}$  = resistance factor for layer  $i$ , and
- $n$  = number of layers providing side resistance.

As described in Section 13.4 (uplift), nominal unit side resistances are calculated using the methods given in Section 13.3.5 for axial compression. The resistance factors for uplift given in Table 10-5 are applied to the nominal resistances and then added to obtain the summation of factored resistances.

Axial force effects to be included on the left side of Equation 13-1 are the nominal load transmitted from the structure to the top of the drilled shaft,  $Q_{TN}$ , plus the nominal uplift force resulting from the expansive geomaterial,  $Q_{UN}$ , calculated in Step 4 above, plus the buoyant weight of the drilled shaft,  $W$ . The load factors applied to the nominal top load ( $\gamma_T$ ) and shaft weight ( $\gamma_P$ ) will depend upon the strength, service, or extreme event limit state load combination being evaluated and will be determined in consultation with the project structural engineer. AASHTO (2007) does not specify a load factor to be applied to the nominal uplift force resulting from expansive soil or rock. It is assumed herein that the maximum load factor applied to downdrag forces is applicable to the uplift case, or  $\gamma_U = 1.25$ . Substituting the applicable loads and resistances into Equation 13-1 yields the following expression for LRFD evaluation of uplift due to expansive materials:

$$1.25Q_{UN} \pm \gamma_T Q_{TN} - \gamma_P W \leq \sum_{i=1}^n \phi_i R_{SN,i} \quad 13-36$$

where all terms are defined above. In Equation 13-36, the sign of the nominal load acting at the top of the shaft ( $Q_{TN}$ ) is negative if acting downward (compression) and positive if acting upward (uplift). Engineering judgment is required in selecting the value of nominal head load that will exist during the period in which uplift loading from expansive geomaterials can develop. The maximum uplift force on the shaft may occur when compressive loads are minimum, which is possible during construction. If the uplift forces from swelling develop in a relatively short period of time after drilled shaft construction and this occurs in combination with a delay in the construction of the substructure/superstructure, a value of  $Q_{TN}$  equal to zero may be appropriate. Kim and O'Neill (1996) report that full uplift loading from cracked, swelling clays can be exerted on drilled shafts within a few days of heavy rains following a prolonged period of dry weather. One might expect the most severe case to be uplift from swelling soil combined with uplift loading at the top of the shaft; however, the direction of interface shearing stress in the expansive material will reverse direction (changing from a load to a resistance) prior to reaching the strength limit state in uplift. However, for this case the service limit state needs to be evaluated to verify that upward displacement of the drilled shaft is within acceptable limits.

Structurally, the shaft is designed to resist the maximum axial tensile force resulting from expansive geomaterials, which is assumed to occur at Point A in Figure 13-24. For this case, the forces and load factors on the left side of Equation 13-1 are the same as those considered above, that is, the factored force transmitted from the structure to the top of the drilled shaft, plus the factored uplift force resulting from the expansive geomaterial, minus the factored weight of the drilled shaft. Structural resistance is provided by the tensile strength of the longitudinal reinforcing bars, leading to the following LRFD equation:

$$1.25Q_{UN} \pm \gamma_T Q_{TN} - \gamma_P W \leq \phi f_y A_s \quad 13-37$$

where:

the sign of  $Q_{TN}$  is negative when acting downward (compression) and  
 $\phi$  = resistance factor for reinforcing steel in tension,  
 $f_y$  = nominal yield strength of longitudinal steel reinforcing bars, and  
 $A_s$  = cross-sectional area of all steel reinforcing bars.

The methods described above have been applied successfully to individual drilled shafts that are subjected to uplift loads from expansive soils. Very little is known about the performance of closely-spaced groups

of drilled shafts in highly expansive soils, so that if it is necessary to design groups of drilled shafts in expansive geomaterials, they should be designed conservatively. For example, any group action, such as was considered for downdrag loading, could be neglected, and each drilled shaft within the group could be designed for expansive geomaterial loading as if it were an isolated shaft.

For the case of a belled shaft in uplift, the bell can be designed as an embedded anchor. A simple method for this case is presented in Appendix C.

A final point should be considered when constructing transportation facilities on sites with expansive soils. The underside of any structural members connecting drilled shafts near the final grade elevation, such as footings, caps, or beams, should have sufficient clearance above the ground surface to avoid uplift from swelling ground. A generous estimate of the amount of swell should be made for determining the necessary distance of the gap between the structure and ground surface.

### **13.8 Summary**

Design for axial loading is one of the major steps in the overall process of design and construction of drilled shafts, as outlined in Chapter 11. In this chapter, the concepts and methods for LRFD design of single drilled shafts under axial loading are presented. For each category of geomaterial, equations are given for calculating nominal values of side and base resistance. Examples are presented to illustrate the application of LRFD limit state checks to the design of drilled shafts under axial compression. An idealized model of load-settlement behavior, based on load test observations, is presented for evaluating the load-settlement behavior of drilled shafts in soil, providing designers with a tool for evaluation of the Service I limit state. More rigorous methods for analyzing load-displacement behavior are covered in Appendix C.

An approach for evaluating scour caused by the design flood and its effects on foundation resistances is summarized. Basic principles are also presented for design of drilled shafts under uplift and for moving ground conditions associated with downdrag and expansive soils.

Archived

This page is intentional left blank.

## CHAPTER 14

### DESIGN OF GROUPS OF DRILLED SHAFTS

#### 14.1 INTRODUCTION

Although one of the advantages of drilled shaft foundations is the small footprint afforded by the use of a single shaft foundation under a single column, there are many occasions in which groups of drilled shafts as shown in Figure 14-1 might be used. The design of drilled shaft groups is not substantially different from the design of other types of deep foundations, except that the use of battered shafts is relatively rare. Also, there are some considerations related to the unique aspects of construction of drilled shafts, and drilled shafts tend to be larger in diameter and stronger in flexure than groups of other types of deep foundations. Drilled shafts can sometimes be used in closer spacing if required by specific constraints of a project site.



Figure 14-1 Group of Drilled Shafts During Construction of the Benetia-Martinez Bridge near San Francisco

This chapter outlines methods for designing groups of drilled shafts based on the techniques described in the previous chapters for designing individual shafts. The focus of this chapter is on the specific considerations used to account for group effects in axial and lateral loading, and the computation of loads to individual shafts due to combined axial, shear, and overturning moments applied to groups of shafts.

## 14.2 GROUP VERSUS SINGLE SHAFT FOUNDATION

The use of groups of drilled shafts should be considered in cases where foundation loads make single shaft foundations unusually large and particularly costly. As illustrated in Figure 14-2, large overturning moments are most effectively resisted using groups of shafts because of the efficient moment resistance produced by the axial resistance of widely spaced shafts within a group. Because of the need for large, heavy equipment to install single shaft foundations larger than 8 ft in diameter, groups of smaller diameter shafts may be more cost effective in many circumstances.

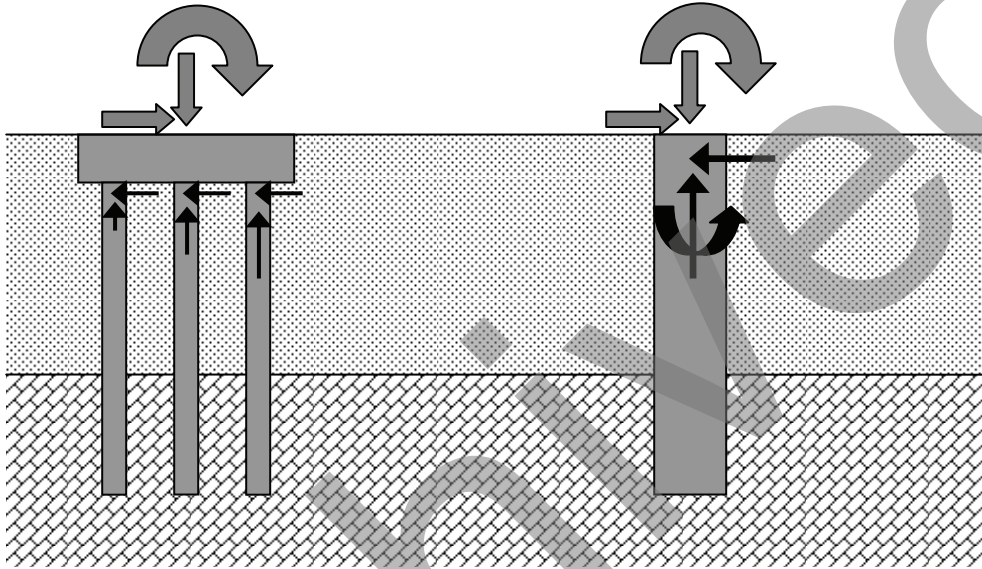


Figure 14-2 Group Versus Single Shaft

Group foundations are less advantageous where the cost or difficulty associated with construction of a pilecap may be significant. In areas where the foundation footprint must be limited in order to fit in or around existing structures, group foundations can present access problems. For over-water foundations, the construction of a cap can be a major expense and more time-consuming to construct. In addition, scour may be less severe with a smaller footprint of a single shaft compared to a group.

In individual cases where the relative advantages of a group or single shaft foundation are not obvious, the designer is encouraged to prepare a preliminary or conceptual design of both alternatives for evaluation of costs, risks, schedule considerations, and other factors. Local chapters of contractor trade associations are typically available for consultation on constructability and cost issues. Many state DOT agencies have regular meetings with such groups for consultation on these issues and upcoming projects.

## 14.3 CONSIDERATIONS FOR SPACING

A minimum spacing of 3 diameters center to center between shafts (2 diameters clear space) is typical of routine practice within the industry. There are occasions where 2.5 diameters on center (1.5 diameters clear) can be advantageous, although the efficiency of the group against overturning moment is reduced

as the shaft spacing is reduced. At close spacings, the sequencing of construction operations must be planned so as to avoid the potential for communication between shafts during excavation and concrete placement. In addition, the drilling of a hole less than 3 diameters on center from an adjacent existing shaft can result in a reduction in lateral stress and/or loosening of the ground around that shaft in some types of materials. Advancement of a casing ahead of the shaft excavation is one means to avoid these adverse effects.

In any case, group effects must be considered at a center to center spacing of less than 4 diameters for axial resistance and less than 5 diameters for lateral resistance.

#### 14.4 GROUP EFFECTS ON AXIAL RESISTANCE

The resistance of a drilled shaft group to vertical load is not necessarily the sum of the axial resistance of the individual shafts within the group. In shaft (or pile) groups, the zone of influence from an individual drilled shaft may intersect with other shafts, depending on the shaft spacing, as illustrated in Figure 14-3. Evaluations of shaft group strength (geotechnical strength limit state) should also consider potential block failure of the group, and the potential contribution of the cap to bearing capacity of the shaft group system (termed occasionally as a pile raft). The designer should be aware that settlement of a shaft group may often exceed that which would be predicted based upon a single drilled shaft analysis.

Besides the effect of overlapping zones of influence, effects of construction on ground conditions in and around the group can be significant. Excavated deep foundation elements (such as drilled shafts and continuous flight auger piles), generally tend to decrease the effective stress of the surrounding soil, or at best maintain it at the at-rest ( $K_o$ ) condition. Changes in effective stress are more pronounced in cohesionless soils. Poorly controlled shaft construction can result in soil loosening during drilling and adversely reduce the lateral stress around previously installed shafts. Some techniques used for drilled shaft construction, such as casing driven in advance of the excavation, may result in densification rather than loosening. In comparison, some types of deep foundations such as driven displacement piles may tend to increase the relative density and effective stress of the surrounding soil.

Effects of construction on ground conditions are less significant in stable geologic formations such as rock, cemented sands, stiff clays, and cohesive intermediate geomaterials such as marl or shale. Although these materials tend to stand in an open hole with less tendency to loosening during the short period of excavation for a drilled shaft, it is important to note the macro-structure of the formation including the potential for geologic discontinuities which can result in communication between shafts during construction. Uncemented sand layers, seams of weathered or decomposed rock, water-bearing fracture zones, and solution cavities can lead to difficulties during installation of closely spaced shafts. These features require careful control of construction operations and sequencing in order to avoid unpredictable adverse consequences to drilled shaft performance.

Note that load cases with significant overturning moments are likely to control the maximum load for design of individual drilled shafts in the group. Often a quick check of group effects for the load case with maximum overall group load will verify that the design of the individual drilled shaft is controlled by overturning as described in Section 14.6 of this chapter.

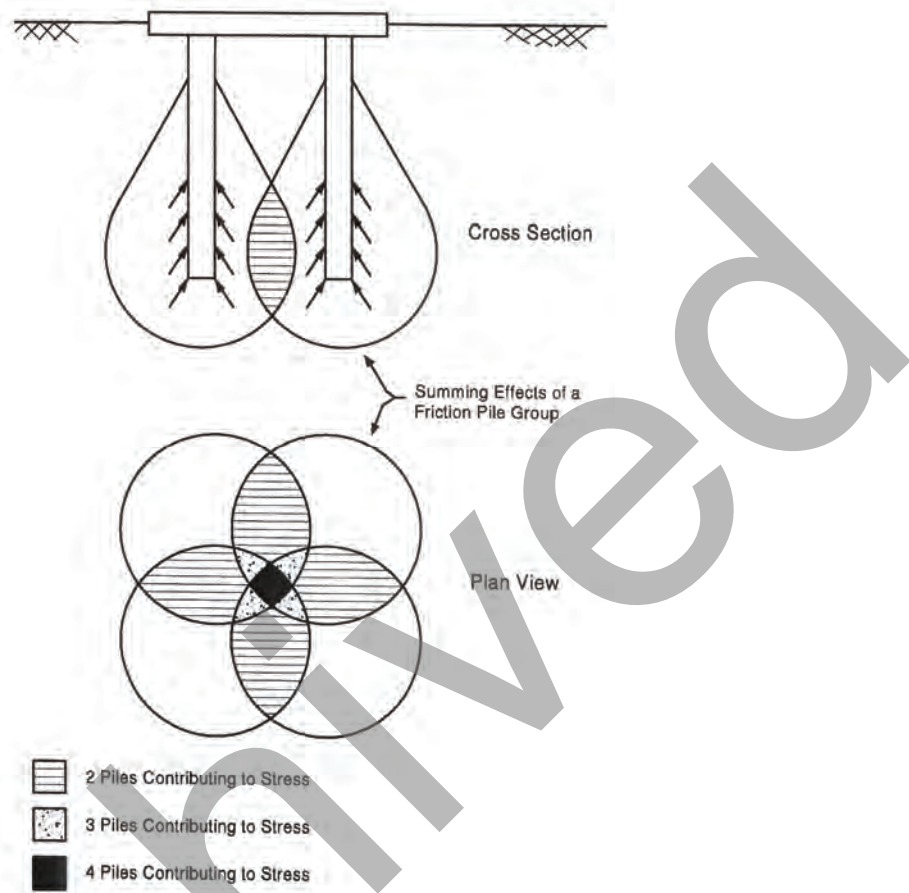


Figure 14-3 Overlapping Zones of Influence in a Frictional Pile Group (after Bowles, 1988)

#### 14.4.1 Group Effects on Strength (Geotechnical Strength Limit State)

The efficiency of a pile group ( $\eta_g$ ) is often defined as:

$$\eta_g = \frac{R_{ng}}{\sum_{i=1}^n R_{n,i}} \quad 14-1$$

where  $R_{ng}$  is the nominal resistance of the shaft group, and  $R_{n,i}$  is the nominal resistance of a single drilled shaft “ $i$ ” in the shaft group with a total of  $n$  shafts in the group.

The overlapping zones of influence from individual drilled shafts in a group, and the tendency for the pile cap to bear on the underlying soils (if in contact) tend to cause the drilled shafts and pile cap system and the soil surrounding the drilled shafts to act as a single unit and exhibit a block type failure mode. The group capacity should be checked to see if a block-type failure mode controls the group capacity, as will be discussed subsequently.



Block failure mode for drilled shaft groups generally will only control the design for drilled shaft groups in soft cohesive soils or cohesionless soils underlain by a weak cohesive layer. Note that closer spacing of the drilled shafts in the group will also tend to increase the potential for the block failure mode.

#### 14.4.1.1 Cohesive Geomaterials

For cohesive geomaterials in which the installation of the foundations is not considered to have a significant effect on the in-situ soil and state of stress, the resistance for the geotechnical strength limit state should be determined from the lesser of a block failure mode or the sum of the individual shaft resistances. That is, the efficiency cannot exceed 1.0 as shown in Equation 14-2. The nominal resistance of the block ( $R_{Block}$ ) is estimated as described to follow, while the individual drilled shaft nominal resistance ( $R_{n,i}$ ) is estimated as described in Chapter 13.

$$\eta_g = \frac{R_{Block}}{\sum_{i=1}^n R_{n,i}} \leq 1 \quad 14-2$$

The resistance of the block failure ( $R_{Block}$ ) mode can be simply estimated as the sum of the side shear contribution from the peripheral area of the block, as shown in Figure 14-4, and the bearing capacity contribution from the block footprint area:

$$R_{Block} = f_{max} \cdot [2 \cdot D \cdot (Z + B)] + q_{max} \cdot (Z \cdot B) \quad 14-3$$

where:  $D$ ,  $Z$ , and  $B$  are the depth, length, and width of the block, respectively. The nominal unit side resistance of the block,  $f_{max}$ , is conservatively computed as if the peripheral surface of the block is a drilled shaft and the base resistance,  $q_{max}$ , is computed using the appropriate procedure for cohesive materials as outlined in Chapter 13. However, the nominal unit base resistance of the block must take into account that the zone of influence for the block is deeper than for a single drilled shaft. This effect may be included by assuming a zone of influence below the block to a depth of approximately 2 to 3 times the block length  $Z$ , and determining  $q_{max}$  by the conventional bearing capacity methods presented in Chapter 13 for this deeper zone of influence.

#### 14.4.1.2 Cohesionless Soils

The current AASHTO provisions for group efficiencies for drilled shafts in cohesionless soils (AASHTO 10.8.3.6.3) states that regardless of cap contact with the ground:

$$\begin{aligned} \eta &= 0.65 \text{ for a center-to-center spacing of 2.5 diameters,} \\ \eta &= 1.0 \text{ for a center-to-center spacing of 4.0 diameters or more, and} \end{aligned}$$

the value of  $\eta$  must be determined by linear interpolation for spacing between 2.5 and 4 diameters.

There is evidence that the recommended values are most likely conservative for drilled shafts in cohesionless soils in circumstances where the pile cap is in firm contact with the ground and contributes significantly to the bearing capacity, and/or when the cohesionless soil is not loosened by the installation process.

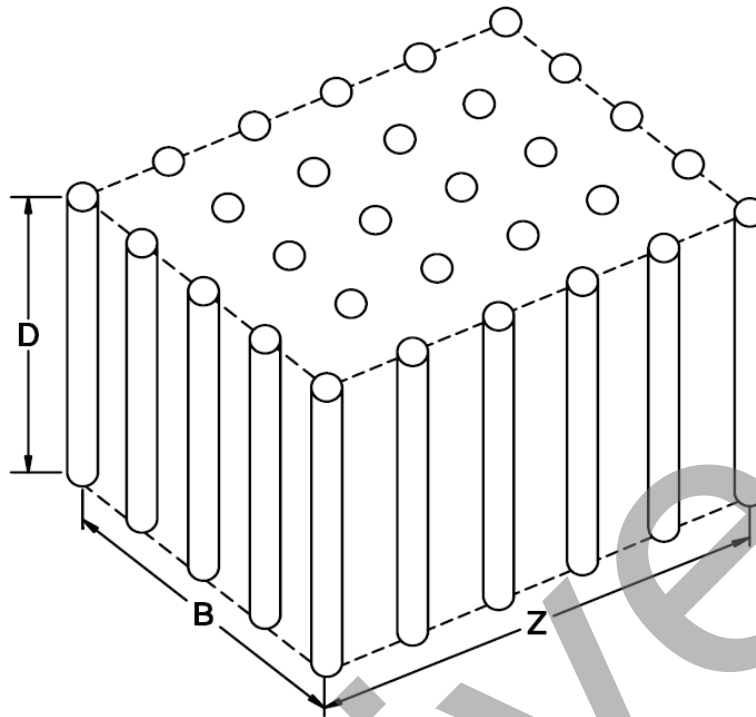


Figure 14-4 Block Type Failure Mode (after Tomlinson, 1994)

Results from small-scale field tests in cohesionless soils from diverse locations around the world suggest that an efficiency of 1.0 or greater may be obtained with pile center-to-center spacing of approximately 3 to 4 diameters. Note that a typical center-to-center spacing of 3 pile diameters would result in a recommended efficiency of 0.76 using the AASHTO provisions cited above.

Studies of drilled shaft groups in cohesionless soils include Garg (1979), Liu et al. (1985), Senna et al. (1993) and Ismael (2001). The shafts did not exceed the range in diameter of 5 to 13 inches, and in length from 8 to 24 times their respective diameter in all four cited studies. Note that all four of the studies were performed in either dry sand or sand with fines above the water table. Efficiencies for groups in clean sands below the water table may be lower than reported in the cited studies due to a greater potential for relaxation of lateral stress.

Garg (1979) conducted model tests of under-reamed shafts compression tested in moist, poorly graded silty sand with SPT-N values ranging from 5 to 15. The efficiency ( $\eta$ ) versus the ratio of Spacing to Diameter ( $S/B_{shaft}$ ) for 2 and 4 pile groups, both with and without the cap in contact with the ground, are shown in Figure 14-5. Note that the efficiency of a group with its pile cap in contact with the ground is consistently higher than its respective group with the cap not in contact with the ground.

Liu et al. (1985) conducted model axial compression tests in moist alluvial silty sand, with a measure of the soil density un-reported. The group effects on side shear and end bearing contributions of the 9 pile groups (3 x 3) are shown in Figure 14-6 versus the ratio of spacing to diameter (spacing/ $B$ ), both with and without the cap in contact with the ground. Note that the cap in contact with the ground results in lower side shear efficiencies but higher end bearing efficiencies than with the cap not in contact with the ground for comparable spacing to diameter ratios.

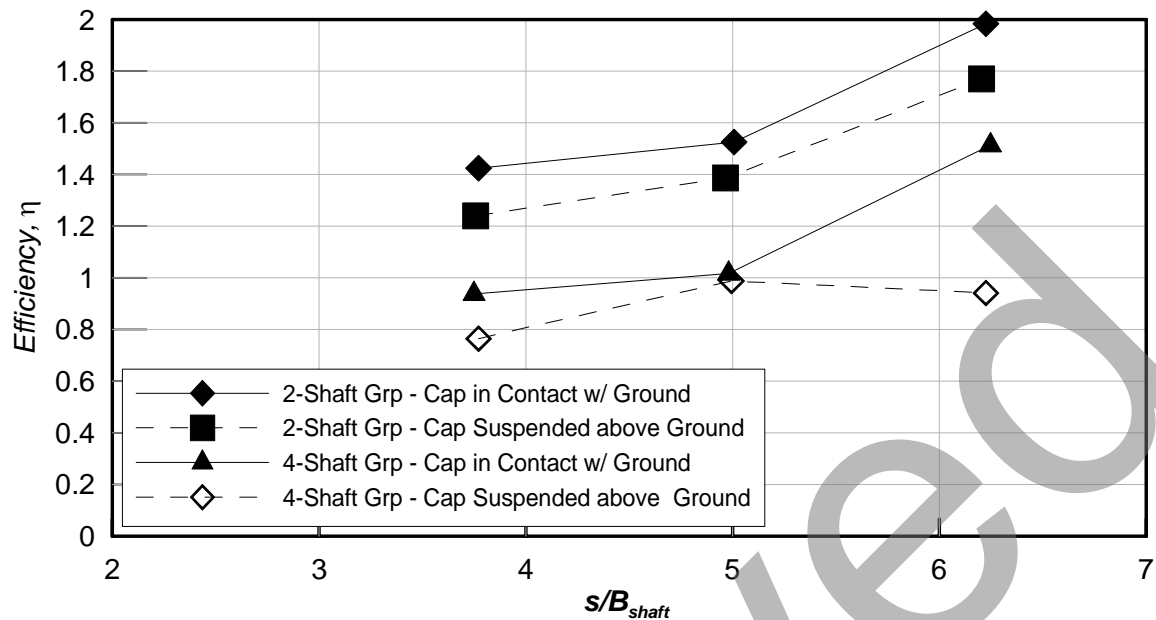


Figure 14-5 Efficiency ( $\eta$ ) versus Center-to-Center Spacing ( $s$ ), Normalized by Shaft Diameter ( $B_{shaft}$ ), for Under-Reamed Model Drilled Shafts in Compression in Moist, Silty Sand. (Modified after Garg, 1979).

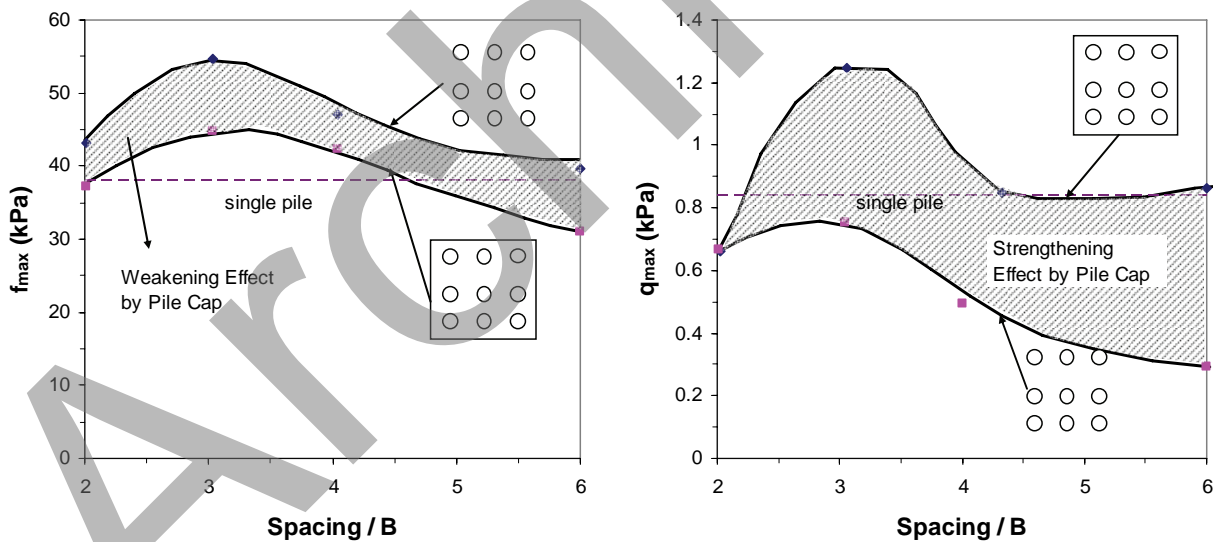


Figure 14-6 Relative Unit Side and Base Resistances for Model Single Shaft and Typical Shaft in a Nine-Shaft Group in Moist Alluvial Silty Sand (Liu et al., 1985). 100 kPa  $\approx$  1 tsf

Senna et al. (1993) conducted model axial compression tests in clayey sand with SPT  $N$ -values ranging from approximately 4 at the surface to as high as 18 at the tip depths (19.7 ft). Four different group configurations were tested and compared to a single pile response with the resulting efficiencies as shown in Table 14-1. Note that all groups had center-to-center spacings of 3 diameters, and all caps were in contact with the ground.

**TABLE 14-1 EFFICIENCY ( $\eta$ ) FOR MODEL DRILLED SHAFTS SPACED 3 DIAMETERS CENTER-TO-CENTER IN VARIOUS GROUP CONFIGURATIONS IN CLAYEY SAND (Senna et al, 1993)**

Configuration	2 x 1 Pile Bent	3 x 1 Pile Bent	3 Triangular Pile Group	4 Square Pile Group
Efficiency	$\eta = 1.1$	$\eta = 1.1$	$\eta = 1.04$	$\eta = 1.0$

Ismael (2001) performed a series of tests on groups of bored piles in a weakly cemented sand in Kuwait with spacings of 2 and 3 diameters on center. He concluded that group efficiencies of 1.2 and 1.9 respectively were observed, with the cap in contact with the ground surface. Strain gauge measurements led Ismael to conclude that the effect of the cap bearing on the soil contributed only a small amount to the resistance and that the overlapping stress in the ground actually increased the resistance of the piles within the group by increasing the frictional resistance at the pile/soil interface.

Results of finite element studies of groups of bored piles in an elastoplastic material with a Drucker-Prager yield surface to simulate a  $c-\phi$  soil were reported by Katzenbach and Moormann (1997). These studies provide a model of the effect of stress overlap absent any installation effects on the soil strength properties or state of stress. The FE model results suggest that piles at a spacing of  $3D$  on center are capable to provide resistance in excess of the maximum resistance mobilized by a single standing pile, albeit at relatively large displacement (Figure 14-7). The pile resistance shown on Figure 14-7 for model 1 is at  $3D$  center-to-center spacing and at  $6D$  spacing for model 2. Note that both models of groups mobilize less resistance at small vertical displacement, and thus serviceability (settlement) is affected differently than the geotechnical strength limit state.

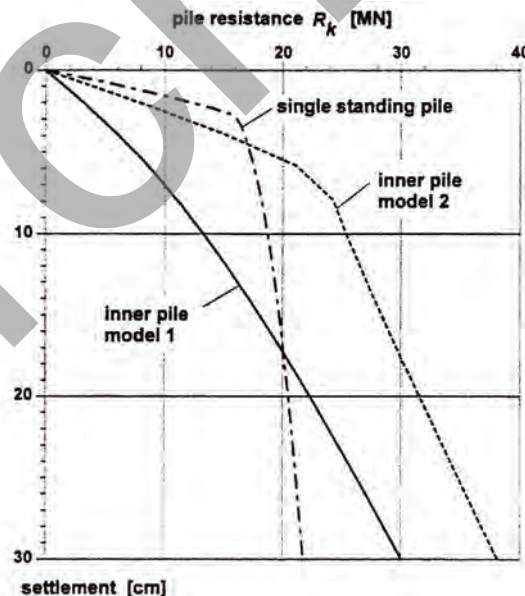


Figure 14-7 Axial Resistance from FE Model Results of Bored Pile Groups (Katzenbach and Moormann, 1997). 1 MN  $\approx$  225 kips; 2.54 cm  $\approx$  1 inch.

While these studies have limitations with respect to drilled shaft design in cohesionless soils, they suggest that there may be circumstances in which the AASHTO specifications would result in a conservative estimate of group resistance at the geotechnical strength limit state. The potential adverse group effects of drilled shaft installation in cohesionless soil are more likely to occur if there are reductions in lateral stress and/or reductions in soil relative density. For granular soils with considerable fines or light cementation, it may be worthwhile to include an evaluation of group effects into the test shaft program. Effects of drilled shaft installation on soil density or stress could be reflected in post-construction in-situ tests (SPT or CPT) within the shaft group. Likewise, verification tests of an interior shaft should provide a representative indication of a typical shaft within a group after installation of the entire group. If reliable interpretations from a well conceived testing program can verify that negative group effects are less severe than indicated by the AASHTO recommendations for drilled shafts, then an alternate approach may be justified on a project-specific basis.

#### **14.4.1.3 Drilled Shaft Group in a Strong Layer with a Weak Underlying Layer**

If a weak formation is present below the foundation layer, the group efficiency should be checked to ascertain whether a group efficiency of less than 1 is warranted. The group efficiency may be checked as described in Section 14.4.1.1, where the individual drilled shaft nominal resistance ( $R_{n,i}$ ) is estimated as described in Chapter 13 and the block extends to the weak layer. It should be noted that a weak layer below the shaft group will, in most cases, present a significant consideration from the standpoint of group settlement as outlined in Section 14.6. Settlement considerations may require that minimum drilled shaft penetration be achieved to an elevation below the compressible layer.

#### **14.4.2 Settlement of Shaft Groups (Serviceability Limit)**

The development of resistances with displacements of individual shafts was discussed in general in Chapter 13. Where groups of drilled shafts are subject to significant vertical loading, the settlement of a shaft group is likely to be significantly greater than the settlement of an individual shaft at the same average load, especially for cases where the soils below the shaft bearing layer are compressible.

The greater settlement of the shaft group is attributed to a deeper zone of influence for the group than that for a single shaft, as illustrated in Figure 14-8.

Settlement of shaft groups can be attributed to a combination of elastic compression of the shafts, and settlement of the surrounding soils. Settlement of the surrounding soils will primarily consist of nearly instantaneous compression for purely cohesionless soils, and primarily time dependant consolidation for purely cohesive soils. Note that layered systems of soils may contain appreciable amounts of both immediate compression and consolidation settlements.

It is worth noting that designers who must consider the effects of pile foundation settlements should carefully consider the magnitude and timing of the application of those loads and their effect on the structure. For instance, the dead load of the column, pier cap, and perhaps other portions of the bridge structure may be in place and settlement due to these loads may be complete before the final connections of any settlement-sensitive portions of the structure are made. It may be that only settlements from the additional loads imposed after the girder bearing plates are set are the movements with significant consequences to the structure.

Simplified methods for estimating pile group settlement are presented in the following sections. The methods presented were formulated for use with driven pile groups, and are considered to be generally representative of drilled shaft group settlements. The deeper zone of influence for a deep foundation group is unlikely to be significantly affected by the type of the deep foundation elements, although differences in individual pile or drilled shaft stiffness and mobilization of capacity can affect settlements to some degree.

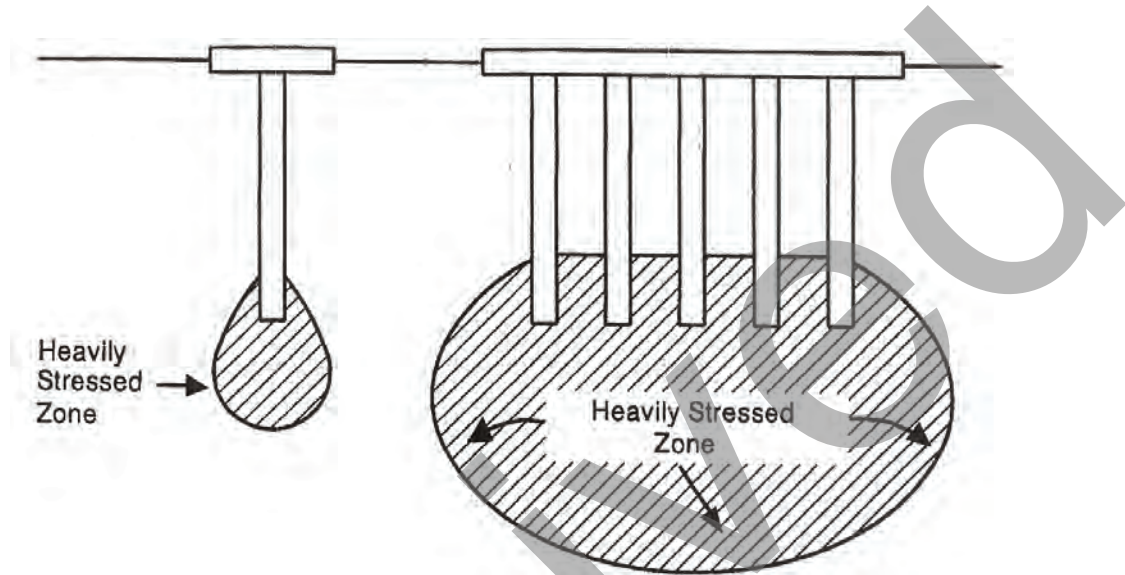


Figure 14-8 Deeper Zone of Influence for End Bearing Shaft Group (after Tomlinson, 1994)

#### 14.4.2.1 Elastic Compression of the Shaft

Elastic compression of the drilled shaft is a function of the imposed load, the shaft stiffness, and the load transfer characteristics from the shaft to the surrounding soil. For many practical problems, a drilled shaft may be considered “rigid” if its stiffness ratio ( $SR$ ) as defined in Equation 14-4, is less than approximately 0.010 ( $SR \leq 0.010$ ). In such cases, the elastic shortening of the shaft is likely to be very small compared to the settlements related to the soil in which the drilled shaft is embedded. Otherwise, elastic compression should be estimated and included in settlement calculations, as well as subtracted from shaft displacement when determining the mobilization of either side or base resistance at values less than the strength limit.

$$SR = \left( \frac{L}{B} \right) \cdot \left( \frac{E_{soil}}{E_{pile}} \right) \quad 14-4$$

where:  $L$  = shaft embedment depth;  
 $B$  = shaft diameter;  
 $E_{soil}$  = average Young’s modulus of the soil; and  
 $E_{pile}$  = Young’s modulus of the drilled shaft.

The elastic compression of a shaft ( $\Delta$ ) may be calculated as the sum of elastic compression of “ $n$ ” shaft segments as follows:

$$\Delta = \sum_{i=1}^n \frac{Q_i \cdot L_i}{A_i \cdot E_i} \quad 14-5$$

$L_i$ ,  $A_i$ , and  $E_i$  are the length, average cross-sectional area, and average composite modulus, respectively, for each of the shaft segments.  $Q_i$  is the average axial load at the shaft segment. The load at the top shaft segment would be the total imposed load to that individual shaft, and would reduce in magnitude down to the mobilized end bearing load at the shaft tip in accordance with the load transfer response of the shaft to soil system. If downdrag or uplift are present, the load distribution would be as described in Chapter 13.

The load imposed to the individual drilled shaft could become a complex solution if the pile cap were to provide a contribution to the total capacity of the shaft group system (i.e. a pile raft), and the group was subject to eccentric effects. However, to estimate the load imposed to the individual shaft for purposes of elastic compression calculations, it may be sufficient to simply divide the total load of the shaft group by the number of shafts.

For many practical problems, an estimate of elastic shortening may be made using simplified assumptions regarding the load distribution in the pile. For example, a constant load transfer rate (i.e. a uniform unit side shear along the entire length of the pile) and axial load supported entirely in side friction would result in a triangular distribution of load in the shaft versus depth ranging from the maximum load at the shaft top to 0 load at the shaft toe. For this condition, the elastic compression may be computed as:

$$\Delta = \left( \frac{1}{2} \right) \cdot \frac{Q_{\max} \cdot L_{\text{shaft}}}{A_{\text{shaft}} \cdot E_{\text{shaft}}} \quad 14-6$$

An upper bound (other than the possibility of downdrag) is represented by a shaft acting as a free standing column with no load transfer along the entire length of the shaft and the total maximum imposed load to the shaft supported in end bearing. For this condition, Equation 14-7 provides an upper bound estimate of elastic shortening in the pile. Note that downdrag or soil swell conditions could present a more significant pile load, and for such a case  $Q_{\max}$  would be determined as described in Chapter 13.

$$\Delta_{\max} = \frac{Q_{\max} \cdot L_{\text{shaft}}}{A_{\text{shaft}} \cdot E_{\text{shaft}}} \quad 14-7$$

Equations 14-6 and 14-7 can be used to quickly estimate the potential magnitude of elastic shortening and determine if more complete evaluation of load distribution is justified for the purpose of computing settlement.

#### 14.4.2.2 Compression Settlement in Cohesionless Soils

Meyerhof (1976) recommended that the compression settlement of a pile group ( $S_{\text{group}}$ ) in a homogeneous sand deposit (not underlain by a more compressible soil at greater depth) be conservatively estimated by the correlations to either SPT  $N$ -values (blows/ft) or to CPT  $q_c$  (tip bearing). Note that if the group were to be underlain by cohesive deposits, time dependent consolidation settlements would be needed as described in the following section. The method proposed by Meyerhof (1976) does not distinguish 60 percent hammer efficiency for the  $N$ -values. However, the 60 percent correction is recommended.

For SPT  $N$ -values in cohesionless soils:

for sands: 
$$S_{group} = \frac{4 \cdot p_f \cdot I_f \cdot \sqrt{B}}{N_{60}'}$$
 14-8

for silty sands: 
$$S_{group} = \frac{8 \cdot p_f \cdot I_f \cdot \sqrt{B}}{N_{60}'}$$
 14-9

For CPT  $q_c$  values in cohesionless saturated soils:

$$S_{group} = \frac{p_f \cdot I_f \cdot B}{2 \cdot q_c}$$
 14-10

where:

- $S_{group}$  = estimated total settlement (inches);
- $p_f$  = foundation pressure (ksf), group load divided by group area (plan view);
- $B$  = width of drilled shaft group (ft.);
- $D$  = drilled shaft embedment depth below grade (ft.);
- $I_f$  = influence factor for group embedment =  $1 - [D/(8B)] \geq 0.5$ ;
- $N_{60}'$  = average corrected SPT  $N$ -value (bpf) within a depth  $B$  below the shaft tip;
- $q_c$  = average static cone tip resistance (ksf) within a depth  $B$  below the shaft tip.

#### 14.4.2.3 Consolidation Settlement in Cohesive Soils

Consolidation settlement of cohesive soils is generally associated with sustained loads and occurs as excess pore pressure dissipates (primary consolidation). For purposes of discussion in this section, the time rate of settlement will not be addressed directly. Design for a total magnitude of settlement for the full sustained dead load on the structure would represent a conservative approach to settlement in cohesive soils. For most structures, a portion of the dead load will be in place (pile cap, column, pier cap, etc.), and consolidation for that portion of the load may be nearly complete, before settlement-sensitive portions of the structure (above the girder bearing plates) are in place. Should computed settlements for total sustained dead load be found to significantly affect the design, it may be prudent to evaluate the time rate of the settlement for construction loads to more accurately assess the post-construction settlements. Time rate of primary consolidation is a topic covered in most geotechnical texts and in FHWA training materials (e.g., Cheney and Chassie, 2002).

The consolidation settlement is driven by the load exerted on the shaft group and resulting stress distribution in the soil below and around the shaft group. The actual stress distribution in the subsurface can be affected by many factors including the soil stratigraphy, relative shaft/soil stiffness, shaft to soil load transfer distribution, pile cap rigidity, and the amount of load sharing between the cap and the drilled shafts. For most practical problems, a simplified model of stress distribution is sufficient to estimate shaft



group settlements. The equivalent footing method is presented below as a simplified method to estimate vertical stress with depth in the soil below the drilled shaft group.

Terzaghi and Peck (1967) proposed that pile group settlements could be evaluated using an equivalent footing situated  $1/3$  of the pile embedment depth ( $D$ ) above the pile toe elevation, and this equivalent footing would have a plan area of the pile group width ( $B$ ) by the pile group length ( $Z$ ). The pile group load over this plan area is then the bearing pressure transferred to the soil through the equivalent footing. The same load is then assumed to spread within the frustum of the pyramid of side slopes of 1(horizontal): 2(vertical), thus reducing the bearing pressure with depth as the area increases ( $P_d$  as a function of depth). This concept is illustrated in Figure 14-9.

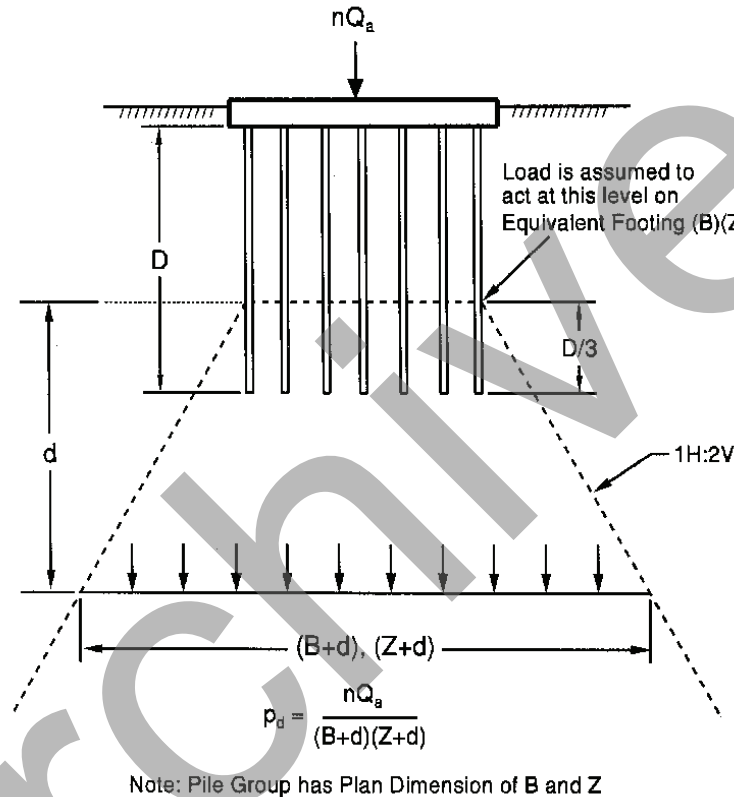


Figure 14-9 Equivalent Footing Concept for Pile Groups (after Terzaghi and Peck, 1967).

In some cases the depth of the equivalent footing should be adjusted based upon soil stratigraphy and load transfer mechanism to the soil, rather than fixing the equivalent footing at a depth of  $1/3 D$  above the shaft toe for all soil conditions. Figure 14-10 presents the recommended location of the equivalent footing for a variety of load transfer and soil resistance conditions.

The cohesive soils below the equivalent footing elevation are broken into layers, and the total consolidation settlement is the sum of the consolidation settlement of all the layers. Note that multiple laboratory curves may need to be generated to accommodate the different layers depending on the soil consistency and maximum past pressures. The settlement of each layer may be calculated as presented in Equations Figure 14-11 through Figure 14-13. A generic example of this consolidation curve is shown in Figure 14-11 to illustrate the terms in these equations.

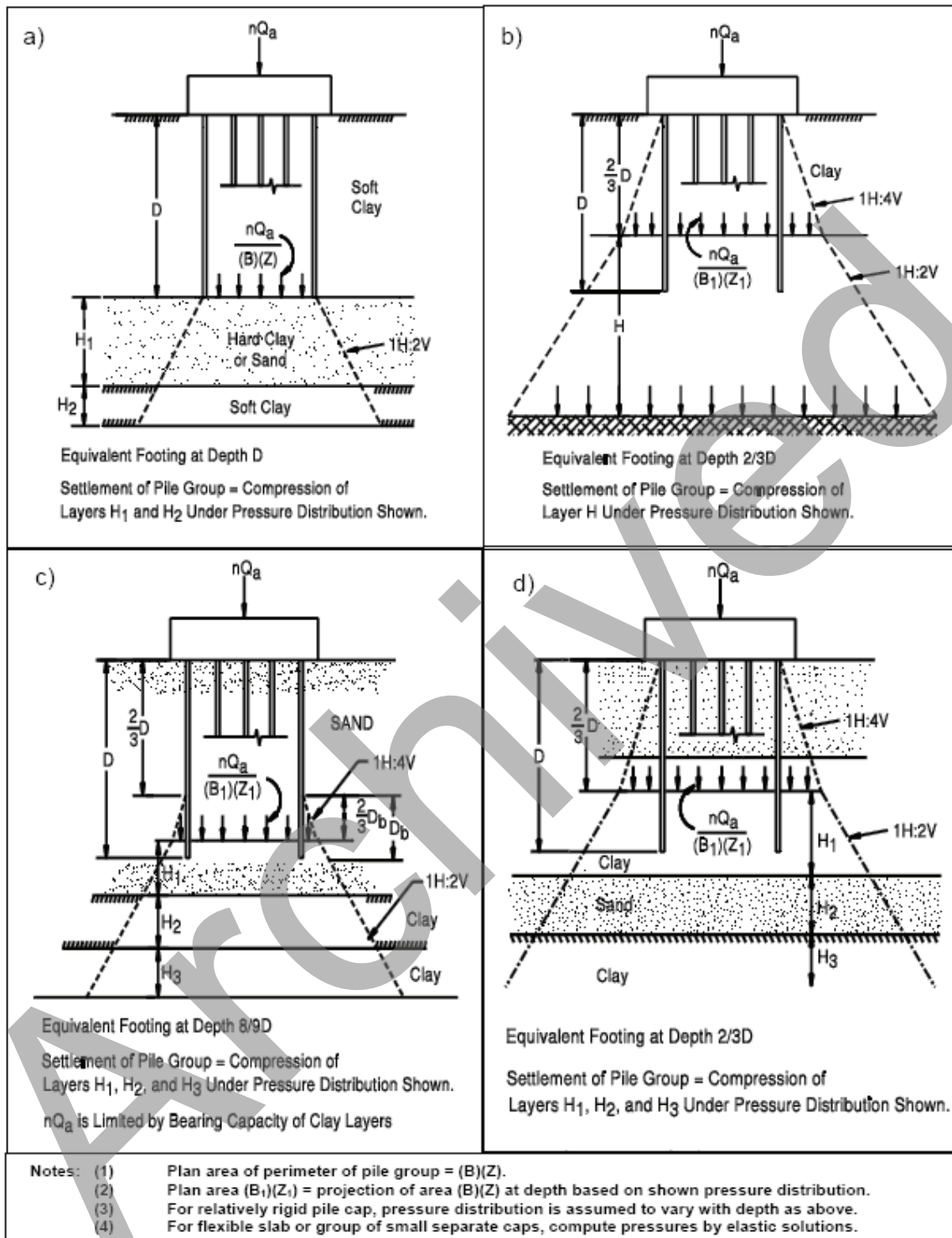


Figure 14-10 Pressure Distribution Below Equivalent Footing for Pile Group (adapted from Cheney and Chassie, 2002).

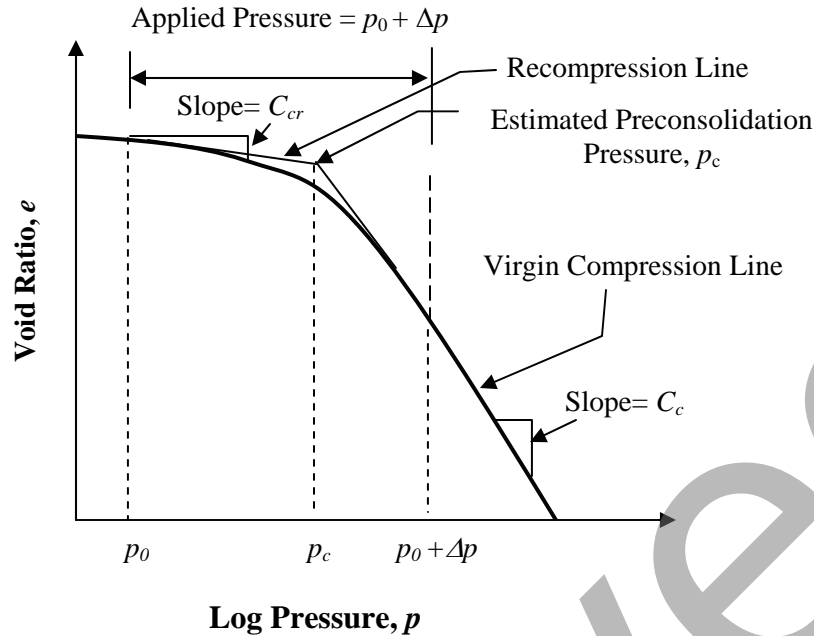


Figure 14-11 Typical  $e$  versus  $\text{Log } p$  Curve from Laboratory Consolidation Testing.

The settlement for an overconsolidated cohesive soil layer ( $S_i$ ) where the pressure after application of the foundation load is greater than the soil preconsolidation pressure ( $p_o + \Delta > p_c$ ):

$$S_i = H \cdot \left[ \frac{C_{cr}}{1 + e_0} \log \left( \frac{p_c}{p_o} \right) \right] + H \cdot \left[ \frac{C_c}{1 + e_0} \log \left( \frac{p_o + \Delta p}{p_c} \right) \right] \quad 14-11$$

The settlement for an overconsolidated cohesive soil layer ( $S_i$ ) where the pressure after the foundation pressure increase is less than the soil preconsolidation pressure ( $p_o + \Delta < p_c$ ):

$$S_i = H \cdot \left[ \frac{C_{cr}}{1 + e_0} \log \left( \frac{p_o + \Delta p}{p_o} \right) \right] \quad 14-12$$

The settlement for a normally consolidated cohesive soil layer ( $p_o = p_c$ ):

$$S_i = H \cdot \left[ \frac{C_c}{1 + e_0} \log \left( \frac{p_o + \Delta p}{p_o} \right) \right] \quad 14-13$$

where:

- $S_i$  = total settlement for layer  $i$ ;
- $H$  = original thickness of stratum or layer;
- $C_c$  = Compression index;
- $C_r$  = Recompression index;
- $e_0$  = Initial void ratio;

- $p_o$  = effective overburden pressure at midpoint of stratum prior to pressure increase;  
 $p_c$  = estimated preconsolidation pressure;  
 $\Delta p$  = average change in pressure.

Note that if the soil were underconsolidated ( $p_o > p_c$ ), as from the placement of substantial fill on the site, the consolidation process due to loads imposed prior to placement of the foundation would still be continuing. This condition would result in an additional downdrag load to the shaft group as discussed in Chapter 13.

### 14.4.3 Group Effects in Rock and Cohesive IGM

Because of the great axial resistance provided by individual drilled shaft foundations in rock and strong cohesive IGM, large groups of drilled shafts are not often required for typical transportation structures founded in these materials. Where groups of drilled shafts are employed, the methods for evaluation of geotechnical strength described for cohesive soils may be used for design; however, because the strength of the rock or IGM mass is usually greater than the strength at the shaft/rock interface, group effects would rarely be expected to control design. Superposition of stresses from adjacent drilled shafts may result in increased deformations of groups of shafts relative to that of isolated individual drilled shafts subject to similar loads; however, settlements of drilled shafts founded on rock and cohesive IGM are usually very small and group effects are not usually significant for transportation structures.

## 14.5 GROUP EFFECTS IN LATERAL LOADING

When laterally loaded drilled shafts are used in closely-spaced groups, a given shaft will deflect further under a given system of loads than if loaded when the neighboring shafts are not present, and bending stresses will increase beyond those that occur when neighboring shafts are not present. It is therefore important to consider group effects due to loading when shaft spacing is less than about six diameters in any direction.

### 14.5.1 P-multiplier Concept

Brown et al. (1987) showed that the behavior of a pile within a 3 X 3 group of free-headed laterally loaded piles with a 3-diameter spacing could be modeled with the same software that is used to analyze a single laterally loaded pile or drilled shaft, provided the p-y curves were scaled with a "p- multiplier,"  $P_m$ . That is, all of the values of soil resistance p are multiplied by a factor that is less than 1, the multiplier, depending upon the location of the shaft within the group and the spacing of the shafts within the group. That is, all along the p-y curve:

$$p_{group\ shaft} = P_m p_{single\ shaft} \quad 14-14$$

This factor reflects a dominant physical situation that develops within a laterally loaded group of drilled shafts or piles: The drilled shafts in the leading row push into the soil in front of the group. The soil reacting against any drilled shaft in this "front row" is relatively unaffected by the presence of the other drilled shafts in the group and only a minor adjustment needs to be made to the p-y curves. However, the shafts in the rows that "trail" the front row are obtaining resistance from soil that is being pushed by the

shafts into the voids left by the forward movement of the drilled shafts in front of them. This phenomenon causes the value of soil resistance,  $p$ , on a  $p$ - $y$  curve to be reduced at any given value of lateral deflection,  $y$ , relative to the value that would exist if the drilled shafts in the forward row were not there. In addition, the presence of all of the shafts in the group produces a mass movement of the soil surrounding the shafts in the group, which reduces the  $p$ -value for a given displacement,  $y$ , to varying degrees for all drilled shafts in the group.

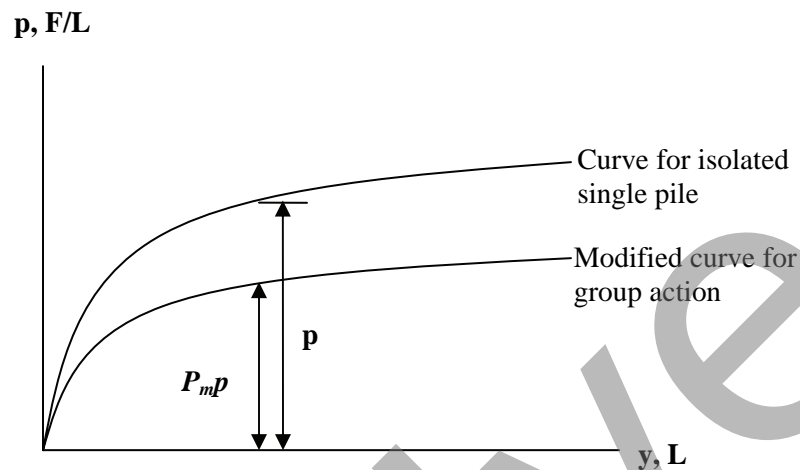


Figure 14-12 The P-Multiplier Concept (Brown, 1987)

Subsequent to these initial field tests, there have been a number of field loading tests, centrifuge model tests, and finite element modeling of simulated tests, the results of which validate the general concept and understanding that the behavior is dominated by row position (Brown et al, 1988; Brown and Shie, 1991; McVay et al, 1995; Pinto et al., 1997; Ruesta et al, 1997; Rollins et al, 1998; Ashford and Rollins, 1999; Brown et al, 2001). A range of values of  $P_m$  have been observed and reported, which suggest the following trends:

1. The greatest reduction in soil resistance occurs between the first row and trailing rows; differences between trailing rows are generally small.
2. Variations in  $P_m$  related to soil type are relatively minor; there is some evidence that the effect of row position is somewhat more pronounced in sands than in clays, but differences related to soil type may be less significant than differences related to installation effects and typical spatial variability of soil properties.
3. Installation of driven displacement piling may influence the distribution of soil resistance within a group in sands because of densification (i.e., higher  $P_m$  in trailing rows than would otherwise be expected), and the effects observed in such field tests would not be expected in groups of drilled shafts.
4. The focus of experimental research on group effects has been at relatively large displacements, as would be anticipated for extreme event loadings. The effects are less pronounced and  $P_m$  values are closer to unity at relatively small lateral shaft displacements of less than one inch.
5. Limited experimental data on groups of piles loaded at a velocity comparable to extreme events such as seismic or vessel impact suggest that  $P_m$  values are similar to those obtained from static loading at similar displacement.

For general design of foundations composed of groups of drilled shafts, the  $P_m$  values provided in Table 14-2 are suggested.

**TABLE 14-2 RECOMMENDED P-MULTIPLIER,  $P_m$ , VALUES FOR DESIGN BY ROW POSITION**

Pile Spacing (c-c)	<i>Design P-multiplier, <math>P_m</math></i>			
	3D	4D	5D	$\geq 6D$
Lead Row	0.7	0.85	1.0	1.0
2 <sup>nd</sup> Row	0.5	0.65	0.85	1.0
3 <sup>rd</sup> and higher Rows	0.35	0.5	0.7	1.0

### 14.5.2 Use of P-multiplier in Computer Codes

If the shaft heads are restrained in any way, moments will develop at the shaft heads that will cause the cap to rotate and to induce compressive and tensile loads in the shafts, such that the sum of the shaft-head moments is resisted by the sum of the push-pull couples in the shafts within the group and possibly partly by soil resistance against the cap. The cap rotation will also serve to relieve somewhat the moments applied to the shaft heads. The engineer can ignore this effect and design using the solutions from the single-shaft computer code, or he or she can use a computer code that considers all of the interactions among the shafts in the group, including this effect.

It should be noted that the p-multiplier approach described above is empirical and based on models which have been calibrated to experiments that are thought to represent typical foundation problems. As an alternative to the p-y method for very complex problems of soil-structure interaction, software now exists that will permit the nonlinear analysis of drilled shafts or groups of drilled shafts using the finite element method (FEM) with relative ease on a high-end PC or a workstation, for example ABAQUS (Hibbett et al., 1996). FEM analysis may be justified when the soil or rock conditions, foundation geometry or loading of the group is unusual.

#### 14.5.2.1 Computer Codes for Analysis of Groups of Shafts

Hoit et al. (1997) describe FBPIER, a computer code that is capable of considering coupled effects of the drilled shafts and pilecap in addition to much more complex three-dimensional group configurations, three-dimensional loading conditions, caps with flexibility, the soil resistance against the cap and similar features. Ensoft, Inc. offer a similar code, called GROUP, that performs the calculations in two or three dimensions. Both codes have the capability of allowing for the consideration of lateral group action within the group through the use of p-multipliers, and both run in a user-friendly Windows environment. Space does not permit the description of these computer codes here; however, the reader is encouraged to obtain and review the literature cited above in preparation for the analysis of complex drilled shaft groups with lateral loads.

The values provided in Table 14-2 may be input into a computer code such as FBPIER or GROUP so that row-specific modification of p-y curves are imposed on individual shafts within the group for the analysis.

The computer code DFSAP (available from the Washington State DOT) uses the strain wedge method to generate relationships of lateral soil resistance against drilled shaft foundations. This method estimates group effects on the lateral soil resistance using overlapping passive soil wedges; accordingly, externally applied scaling effects as described in the previous section are not applied.

### 14.5.2.2 Analyses of Single Shafts for Group Model

Alternatively, the approach outlined by Brown and Bollmann (1993) may be used with multiple separate analyses of single shafts in order to compute the overall group response and the distribution of shear and moment to individual shafts within the group. The results from a computer analysis of a single drilled shaft can be used to compute a lateral load versus deflection response as indicated on Figure 14-13; at a given deflection, the total lateral resistance of the entire group will be the sum of the lateral resistances of the individual shafts at that deflection. Note that the variation in lateral load between drilled shafts in the group is less significant than the variation in P-Multipliers between rows.

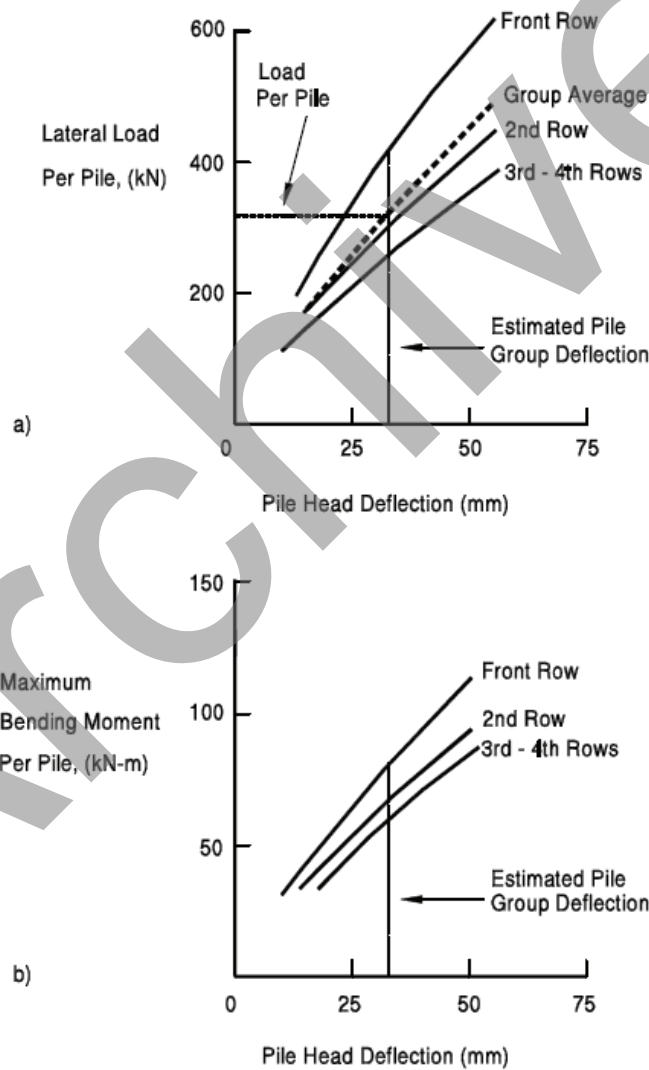


Figure 14-13 Example Plots of Lateral Load Response by Row Position. 25.4 mm = 1 inch; 1 kN-m = 0.738 ft-kips

An alternative and simpler approach is to analyze the response of shafts in the group using an average  $P_m$  value for all of the shafts within the group. The average  $P_m$  value is computed by using a weighted average for all of the shafts based on the individual  $P_m$  values given in Table 14-2. Analyses and experimental data suggest (Brown et al, 2001) that this simpler approach:

1. captures the overall group stiffness to lateral loading with sufficient accuracy for design, given the numerous other uncertainties in real-world behavior
2. allows analyses of multi-directional loading with a single model without the need to adjust row-dependent  $P_m$  variables
3. can accommodate variation in maximum bending moment in any shaft within the group by using a simple overstress allowance above the maximum bending moment computed for the average shaft. For shafts at various center-to-center spacing, the maximum bending moment for any shaft within the group would be no greater than the computed maximum bending moment for the average shaft multiplied by the following:
  - 3D c-c, use  $M_{\max} = 1.2 \times M_{\max, \text{average}}$
  - 4D c-c, use  $M_{\max} = 1.15 \times M_{\max, \text{average}}$
  - 5D c-c, use  $M_{\max} = 1.05 \times M_{\max, \text{average}}$

In general and for simplicity, all of the shafts within a group will be designed to include the same reinforcement.

### 14.5.3 Strain Wedge Approach

The strain wedge model (Ashour et al, 1998) was described in Chapter 12 (Section 12.3.3.4.9) as an alternative approach to modeling the lateral soil resistance acting against a drilled shaft. With this model, the estimated geometry of the overlapping passive soil wedges provide a means of computing the effects of drilled shaft spacing on the lateral soil resistance. The computer code DFSAP referenced in Chapter 12 is presently the only available code which incorporates the strain wedge model. The reader should refer to the documentation available with this software for a complete description of the assumptions, computational procedures, and features associated with this approach.

## 14.6 COMBINED LOADING AND COMPUTATION OF LOAD DISTRIBUTION TO GROUP

Efficient design of groups of drilled shafts requires analysis of group behavior in order to determine the distribution of forces to the individual shafts from combined loadings. An efficient group will distribute forces such that the resistance of all of the shafts in the group is utilized for the most critical load conditions.

For groups of shafts subjected to combined axial, lateral, and overturning forces, calculation of load distribution to the group may use one of the following approaches (in order of increased complexity):

- Simple static equilibrium (if the group can be modeled as a determinate frame)
- Elastic solution (model the individual shaft resistance with springs and the cap as a rigid body)
- Nonlinear solution (using a nonlinear computer code such as GROUP or FBPIER)



The simple static or elastic solutions are suitable for routine design, but may overestimate load concentrations to some individual shafts within the group for extreme event load cases where deflections are large. In such cases a nonlinear solution may be used to better represent the vertical, transverse, and rotational stiffness of the group, and more realistically model conditions at or approaching the geotechnical strength limit state condition.

The following sections provide an overview of the simple solutions that can be performed by hand, and a general description of the use of nonlinear computer solutions for shaft group problems.

### 14.6.1 Simple Static Equilibrium

For very simple group arrangements, it is possible to compute individual loads on the shafts within the group using equations of static equilibrium. This approach presumes a weighted average  $p$ -multiplier as described in Section 14.5.2.2. For purposes of this simple static analysis, the rotational restraint provided by the shaft head to rotation of the cap is ignored (inclusion of this component would make the problem statically indeterminate), and the moment applied to the cap is assumed to be resisted solely by shaft axial forces. Axial stiffness of all shafts in the group is assumed to be the same.

For example, consider a simple four shaft group in a 2 x 2 arrangement with a two-dimensional loading condition as shown on Figure 14-14. Shaft spacing,  $s$ , is 3D center to center ( $D =$  shaft diameter) and the cap has thickness,  $t$ , and weight,  $W_c$ . The lateral loading,  $Q_x$ , is in the  $x$  direction and the vertical loading,  $Q_z$ , in the  $z$  direction, with an applied overturning moment,  $M_{xz}$ , in the  $x$ - $z$  plane. The shaft resistances are modeled as an axial resistance,  $R_{zi}$ , which may vary with position, and a horizontal resistance,  $R_x$ , which is assumed as equal for all shafts. The moment at the head of each shaft is ignored.

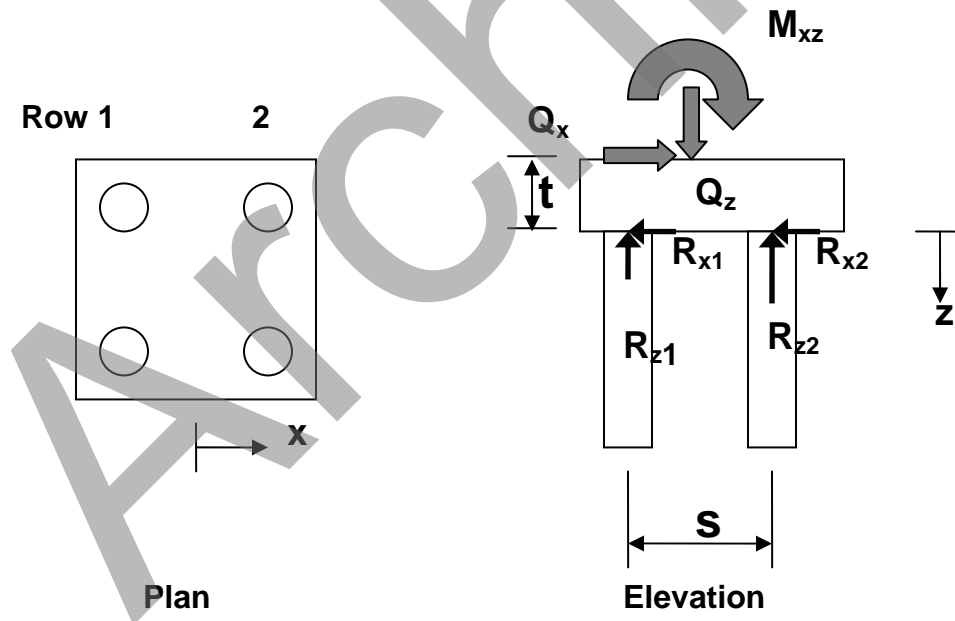


Figure 14-14 Simple Static Analysis of a 2 x 2 Group

For these simplifying assumptions, the resulting forces can be computed by statics. Force equilibrium in the x-direction:

$$Q_x = \sum R_x ; \quad 14-15$$

Therefore, since there are four shafts in the group:

$$R_x = Q_x/4 \quad 14-16$$

Since the axial stiffness of all the shafts is the same, force equilibrium in the z-direction is:

$$Q_z + W_c = \sum R_{zi}, = 2(R_{z1}) + 2(R_{z2}) \quad 14-17$$

Rearranging Equation 14-17:

$$R_{z1} = (Q_z + W_c)/2 - R_{z2} \quad 14-18$$

Summing moments about the top of row 1:

$$M_{xz} + (Q_z + W_c)(1.5D) + (Q_x)(t) = 2(R_{z2})(3D) \quad 14-19$$

Therefore, Equation 14-19 can be rearranged to:

$$R_{z2} = [M_{xz} + (Q_z + W_c)(1.5D) + (Q_x)(t)]/6D \quad 14-20$$

And Equation 14-20 can be substituted into Equation 14-18:

$$R_{z1} = (Q_z + W_c)/2 - [M_{xz} + (Q_z + W_c)(1.5D) + (Q_x)(t)]/6D \quad 14-21$$

Consider the following example:

- 2 x 2 group of 4-ft diameter shafts (D=4 ft, s = 12 ft)
- Cap is 20 ft by 20 ft, 4 ft thick,
- $W_c = (20)(20)(4)(0.15 \text{ k/cu.ft.}) = 240 \text{ kips}$
- $Q_z = 1500 \text{ kips}$
- $Q_x = 120 \text{ kips}$
- $M_{xz} = 1800 \text{ kip-ft}$

The forces on individual shafts are then:

$$\begin{aligned} R_{z2} &= [M_{xz} + (Q_z + W_c)(1.5D) + (Q_x)(t)]/6D \\ &= [1800 + (1500+240)(6) + (120)(4)]/24 \\ &= 530 \text{ k/shaft} \end{aligned}$$

$$\begin{aligned} R_{z1} &= [M_{xz} + (Q_z + W_c)(1.5D) + (Q_x)(t)]/6D - (Q_z + W_c)/2 \\ &= (1500+240)/2 - [1800 + (1500+240)(6) + (120)(4)]/24 \\ &= 340 \text{ k/shaft} \end{aligned}$$

$$R_x = Q_x/4 = 30 \text{ k/shaft (average)}$$

Design for individual shafts would then be performed for an axial load demand of 530 kips and a lateral load demand of 30 kips. For the lateral analysis, the analysis of a single shaft would be performed using an average P-multiplier from Table 14-2:

$$P_m = [2(0.7) + 2(0.5)]/4 = 0.6$$

And the computed maximum moment in the shaft for the single shaft analysis would be multiplied by 1.2 to account for variation within the group (Section 14.5.2.2) for 3D center-to-center shaft spacing.

### 14.6.2 Simple Elastic Solution

For most group arrangements, it is possible to compute group deflections and individual loads on the shafts within the group by hand using a simple elastic solution. With this approach, the axial, transverse, and rotational stiffness of each shaft is modeled as a simple elastic spring. The cap is typically assumed to deform as a rigid body. The shafts may be modeled each with different lateral stiffness or by using the same stiffness based on analyses with a weighted average p-multiplier as described in Section 14.5.2.2. The rotational restraint provided by the shaft head to rotation of the cap can be included in the model, although the rotational stiffness from this source is typically much smaller than the stiffness resulting from the axial shaft forces times their moment arm.

For example, consider a simple six shaft group in a 2 x 3 arrangement with a two-dimensional loading condition as shown on Figure 14-15. Shaft spacing,  $s$ , is 3D center to center ( $D$  = shaft diameter) and the cap has thickness  $t$  and weight,  $W_c$ . The lateral loading,  $Q_x$ , is in the  $x$  direction and the vertical loading,  $Q_z$ , in the  $z$  direction, with an applied overturning moment,  $M_{xz}$ , in the  $x$ - $z$  plane.

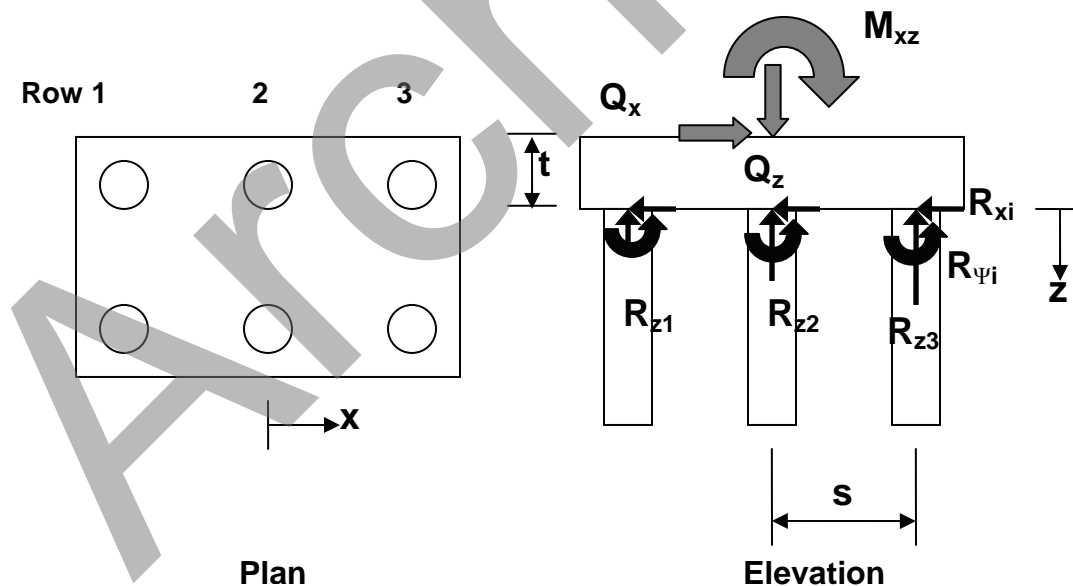


Figure 14-15 Simple Static Analysis of a 2 x 3 Group

The shaft forces are modeled as an axial resistance,  $R_{zi}$ , and a horizontal resistance,  $R_{xi}$ , each of which may vary with position and are assumed to be a linear function of shaft head displacements,  $\Delta_{zi}$  and  $\Delta_{xi}$ , in the z and x directions, respectively, in accordance with the stiffnesses in the x and z directions:

$$R_{xi} = k_{xi}\Delta_{xi} \quad 14-22$$

$$R_{zi} = k_{zi}\Delta_{zi} \quad 14-23$$

The moment at the head of each shaft,  $R_{\psi_i}$ , is assumed to be a linear function of cap rotation,  $\Psi_{zz}$ , in accordance with the rotational stiffness of an individual shaft:

$$R_{\psi_i} = k_{\psi_i} \Psi_i \quad 14-24$$

The translational and rotational stiffness of the group about the bottom center of the cap (center of coordinate system, located here for convenience) can be defined by summing the individual shaft stiffnesses as outlined below. The equations shown are for simple groups composed of vertical drilled shafts only; battered shafts require consideration of the x and z components of the axial and transverse shaft stiffness due to the difference in the local (shaft) axes and the global axes.

For a group of vertical shafts, the total resistance of the group in the x and z directions is:

$$R_{Gx} = \sum k_{xi}\Delta_{xi} \quad 14-25$$

$$R_{Gz} = \sum k_{zi}\Delta_{zi} \quad 14-26$$

and the moment resistance of the group in the z-x plane is:

$$R_{G\Psi} = \sum k_{\psi_i} \Psi_i + \sum k_{zi}\Delta_{zi}x_i \quad 14-27$$

where  $x_i$  is the x-coordinate of the top of the shaft as indicated on Figure 14-15.

Note that the simple solution described above ignores cross-coupling stiffness terms for individual shafts; i.e., the cross terms between rotation and translation of an individual shaft at the head. For typical shaft groups, these terms would be relatively insignificant and small compared to the accuracy with which other parameters are known.

Individual shaft displacements and rotations are related to the group displacements and rotations as follows:

$$\Delta_{xi} = \Delta_{Gx} \quad 14-28$$

$$\Delta_{zi} = \Delta_{Gz} + \Psi_G x_i \quad 14-29$$

$$\Psi_i = \Psi_G \quad 14-30$$

Substituting Equations 14-28 through 14-30 into Equations 14-25 through 14-27 provides:

$$R_{Gx} = [\sum k_{xi}]\Delta_{Gx} \quad 14-31$$

$$\begin{aligned} R_{Gz} &= [\sum k_{zi}] \{ \Delta_{GZ} + \Psi_G x_i \} \\ &= [\sum k_{zi}] \{ \Delta_{GZ} \} + [\sum k_{zi} x_i] \{ \Psi_G \} \end{aligned} \quad 14-32$$

$$\begin{aligned} R_{G\psi} &= \sum k_{\psi i} \Psi_G + \sum k_{zi} (\Delta_{GZ} + \Psi_G x_i) x_i \\ &= \sum k_{zi} (\Delta_{GZ}) x_i + \sum k_{\psi i} \Psi_G + \sum k_{zi} (\Psi_G x_i) x_i \\ &= [\sum k_{zi} x_i] (\Delta_{GZ}) + [\sum k_{\psi i} + \sum k_{zi} (x_i)^2] \Psi_G \end{aligned} \quad 14-33$$

The solution is obtained by substituting the applied forces for the resistance (R) terms in Equations 14-31 through 14-33 and solving the three simultaneous equations for the group displacements. These equations can be expressed in matrix form as:

$$\begin{bmatrix} \sum k_{xi} & 0 & 0 \\ 0 & \sum k_{zi} & \sum k_{zi} x_i \\ 0 & \sum k_{zi} x_i & \sum k_{\psi i} + \sum k_{zi} (x_i)^2 \end{bmatrix} \begin{Bmatrix} \Delta_{GX} \\ \Delta_{GZ} \\ \Psi_G \end{Bmatrix} = \begin{Bmatrix} F_{Gx} \\ F_{Gz} \\ M_G \end{Bmatrix} \quad 14-34$$

or, alternatively:

$$\begin{bmatrix} K_X & 0 & 0 \\ 0 & K_Z & K_{Z\psi} \\ 0 & K_{\psi Z} & K_{\psi} \end{bmatrix} \begin{Bmatrix} \Delta_{GX} \\ \Delta_{GZ} \\ \Psi_G \end{Bmatrix} = \begin{Bmatrix} F_{Gx} \\ F_{Gz} \\ M_G \end{Bmatrix} \quad 14-35$$

where the stiffness matrix terms are as indicated.

The force vectors are the net resultant applied forces at the center of the coordinate system as used to develop the equations (bottom center of the cap). Note that since there are no batter shafts, then the first equation (top row) is uncoupled from the other two and the calculations are simplified.

The following example demonstrates, consistent with the illustration on Figure 14-15:

- 2 x 3 group of 4-ft diameter shafts (D=4 ft, s = 12 ft)
- Cap is 20 ft by 32 ft in plan, 5 ft thick,
- $W_c = (20)(32)(5)(0.15 \text{ k/cu.ft.}) = 480 \text{ kips}$
- $Q_z = 2500 \text{ kips}$
- $Q_x = 180 \text{ kips}$
- $M_{xz} = 1800 \text{ kip-ft}$

Analyses of an individual shaft subject to lateral loading were performed using LPILE with a full moment connection to the cap assumed at the top of the shaft. For simplicity, the LPILE analyses have been performed using an average P-multiplier (Table 14-2):

$$P_m = [2(0.7) + 2(0.5) + 2(0.35)]/6 = 0.52$$

The analyses determined that an individual drilled shaft would deflect approximately 0.25 inches for a lateral force at the top of 30 kips and the shaft head restrained against rotation (fixed head condition). Therefore, the individual shaft stiffness against horizontal translation is:

$$k_{xi} = 30/0.25 = 120 \text{ kips per inch}$$

and the group stiffness term,  $K_x$  is:

$$K_x = \sum k_{xi} = 120(6) = 720 \text{ kips per inch}$$

The analyses determined that an individual drilled shaft would rotate approximately 0.002 in/in for an overturning moment at the top of 100 kip-ft. Therefore the individual shaft stiffness against rotation is:

$$k_{\psi_i} = 100/0.002 = 50,000 \text{ kip-ft per inch/inch}$$

Analyses of axial deformation under short term loading of individual shafts following the procedures outlined in Chapter 13 indicate that an axial deformation of around 0.125 inches is anticipated for an axial load on an individual shaft of 400 kips. Therefore, the individual shaft stiffness against vertical displacement is:

$$k_{zi} = 400/0.125 = 3200 \text{ kips per inch}$$

The remainder of the group stiffness terms are:

$$K_z = \sum k_{zi} = 3200(6) = 19,200 \text{ kips per inch}$$

$$K_{z\psi} = K_{\psi z} = \sum k_{zi}x_i = 3200(2)(-24\text{ft}) + 3200(2)(+24\text{ft}) = 0 \text{ k-ft/in.}$$

$$\begin{aligned} K_{\psi} = \sum k_{\psi_i} + \sum k_{zi}(x_i)^2_i &= (50,000)(6) + 3200(2)(-24)^2 + 3200(2)(24)^2 \\ &= 300,000 + 3,686,400 + 3,686,400 = 7,672,800 \text{ k-ft/(in/in)} \end{aligned}$$

Note that the rotational stiffness contribution ( $\sum k_{\psi_i}$ ) related to the individual shaft head rotational stiffness is more than an order of magnitude smaller than the rotational stiffness contribution of the axial force couples.

The forces on the group are as follows.

$$Q_x = 180 \text{ kips}$$

$$Q_z + W_c = 2980 \text{ kips}$$

$$M_{xz} + Q_x(t) = 1800 + 180(5) \text{ kip-ft} = 2700 \text{ kip-ft}$$

The terms in Equation 14-35 can now be shown as:

$$\begin{bmatrix} 720 & 0 & 0 \\ 0 & 19,200 & 0 \\ 0 & 0 & 7,672,800 \end{bmatrix} \begin{Bmatrix} \Delta_{Gx} \\ \Delta_{Gz} \\ \Psi_G \end{Bmatrix} = \begin{Bmatrix} 180 \\ 2,980 \\ 2,700 \end{Bmatrix}$$

and the solution for the displacement vector is:

$$\Delta_{GX} = 180/720 = 0.25 \text{ inches}$$

$$\Delta_{GZ} = 2980/19,200 = 0.155 \text{ inches}$$

$$\Psi_G = 2700/7,672,800 = 0.000352 \text{ inch/inch}$$

So the individual shaft displacements can be determined using Equations 14-28 and 14-29:

$$\Delta_{xi} = \Delta_{Gx} = 0.25 \text{ inches, all shafts Rows 1-3}$$

$$\Delta_{zi} = \Delta_{Gz} + \Psi_G x_i$$

$$\Delta_{z1} = 0.155 \text{ in} + 0.000352 (-24 \text{ ft})(12 \text{ in/ft}) = 0.054 \text{ inches, Row 1}$$

$$\Delta_{z2} = 0.155 \text{ in} + 0.000352 (0)(12 \text{ in/ft}) = 0.155 \text{ inches, Row 2}$$

$$\Delta_{z3} = 0.155 \text{ in} + 0.000352 (24 \text{ ft})(12 \text{ in/ft}) = 0.256 \text{ inches, Row 3}$$

The individual shaft forces can be determined using Equations 14-22 and 14-23:

$$R_{xi} = k_{xi}\Delta_{xi} = (120 \text{ k/in})(0.25 \text{ in}) = 30 \text{ kips, all shafts Rows 1-3}$$

$$R_{zi} = k_{zi}\Delta_{zi}$$

$$R_{z1} = (3200 \text{ k/in})(0.054 \text{ in}) = 173 \text{ kips/shaft, Row 1}$$

$$R_{z2} = (3200 \text{ k/in})(0.155 \text{ in}) = 496 \text{ kips/shaft, Row 2}$$

$$R_{z3} = (3200 \text{ k/in})(0.256 \text{ in}) = 819 \text{ kips/shaft, Row 3}$$

So, the maximum axial load per shaft for design is 819 kips. The lateral shaft design should be completed using an analysis of a single shaft with a lateral force of 30 kips and a rotation of 0.000352 at the shaft head, and a p-multiplier,  $P_m = 0.52$ . The maximum computed bending moment in the shaft should be multiplied by 1.2 to account for variation in load distribution to the shafts within the group.

### 14.6.3 Nonlinear Computer Solution

For three dimensional loadings of a group of drilled shafts, a computer code is very useful in performing the length computations needed to determine the distribution of forces to the individual drilled shafts. There are a number of available computer codes which can be used for this purpose, and the use of a computer can provide a powerful analysis tool so that the design engineer can quickly optimize the layout of individual drilled shafts within a group for maximum efficiency.

Computer codes such as those described in Section 14.5.2.1 include the capability to account for nonlinear effects in the axial and lateral soil resistance, nonlinear flexural response of the drilled shaft to bending moments, and group effects on the lateral soil resistance. Some codes may include the lateral soil resistance provided by an embedded cap. However, many of the issues related to group effects on axial resistance described in Section 14.4 (particularly those related to settlement of groups of drilled shafts) are not addressed in typical computer codes used for structural analysis of bridge foundations.

Powerful three dimensional nonlinear finite element codes used in geotechnical engineering may be useful for computation of settlement of groups of drilled shafts, but the use of these tools for bridge foundations is not common practice. Settlement does not often control the design of bridge foundations as might be the case for a high rise building or a pile-supported embankment.

The capabilities of computer software are rapidly evolving, and many general purpose codes used for structural analysis are incorporating features for nonlinear analysis of foundation elements. A model which incorporates multiple piers and multiple nonlinear foundations can be very useful in the analysis of extreme event loads such as vessel impacts or a train derailment, because a portion of a large transient load which is applied to one foundation can be redistributed through the structure to other foundations. A more efficient and cost-effective design often results from the use of these more sophisticated analytical tools.

A description of the capabilities and characteristics of individual computer codes is beyond the scope of this manual, and the reader should refer to the documentation to understand the features of specific software used for analysis.

## **14.7 SUMMARY**

This chapter has provided an overview of the considerations for the design of groups of drilled shafts. Although drilled shafts are often used to greatest advantage by utilizing a single drilled shaft at each individual column locations to avoid the need for a cap, extremely large diameter drilled shafts may be costly or inefficient. Groups of drilled shafts are seen to provide capabilities to support much larger foundation loads, particularly where large overturning moments are applied. The effects of spacing and group dimensions on axial and lateral soil resistance are described in this chapter, along with methods of analysis used to incorporate group effects. The analytical methods described in this chapter demonstrate how the analyses may be performed to determine the distribution of loads to the drilled shafts within a group and thereby design the layout of the group and the individual drilled shafts within the group for the computed forces.

In many cases, the large controlling load cases which may necessitate the use of a group of drilled shafts are derived from consideration of extreme event loadings. Chapter 15, which follows, provides a discussion of the design of drilled shafts for extreme events.



## CHAPTER 15

### DESIGN FOR EXTREME EVENTS

Extreme-Event Limit States refer to events with return periods in excess of the design life of the bridge or other structure. There are generally five such limit states that may affect either the force effects transmitted to the drilled shafts or drilled shaft resistances:

- Scour resulting from the occurrence of a superflood in order of magnitude of a 500-year flood (the *check* flood).
- Earthquakes
- Loading from ice
- Collision by floating vessels
- Collision by vehicles

As noted in Section 10.3, scour resulting from the 100-year flood (the *design* flood) is evaluated as part of all Strength Limit States and Service Limit State I and is not considered an extreme event. Only scour due to the check flood, an extreme event, is addressed in this chapter.

#### 15.1 DESIGN FOR EXTREME EVENT SCOUR

Bridge foundations should be checked to ensure that they will not fail due to scour resulting from the occurrence of a superflood in order of magnitude of a 500-year flood (the *check* flood). The check flood is treated in AASHTO (2007a) as an extreme event. The commentary under Article 10.5.5.3.2 states:

“The foundation shall be designed so that the nominal resistance remaining after the scour resulting from the check flood (see Article 2.6.4.4.2) provides adequate foundation resistance to support the unfactored Strength Limit States loads with a resistance factor of 1.0. For uplift resistance of piles and shafts, the resistance factor shall be taken as 0.80 or less. The foundation shall resist not only the loads applied from the structure, but also any debris loads occurring during the flood event.”

According to the above statement, there is no separate load combination corresponding to extreme event scour. The load combinations considered are those corresponding to the strength limit states for which the bridge is designed. These load combinations are given in Table 10-3. Design for extreme event scour under the check flood is distinguished from design for scour under the design flood by the following:

- (1) the scour prism resulting from the 500-year check flood will be different, generally deeper, than scour resulting from the 100-year design flood
- (2) loads used for structural modeling, which determines foundation force effects, are unfactored for evaluation under the check flood; scour under the design flood is incorporated into normal strength limit state design with load factors as specified in Tables 10-3 and 10-4.
- (3) Resistance factors are taken equal to 1.0 (0.80 for uplift and lateral geotechnical resistance) for extreme event scour; resistance factors for the design flood scour are those given in Table 10-5 for normal evaluation of strength limit states

As described in Chapter 10, design for geotechnical lateral stability is based on a “pushover” analysis procedure (presented in Chapter 12) intended to provide a check on the ability of a drilled shaft to

withstand the factored loads without becoming unstable and to ensure a ductile lateral response. This method is not included in current AASHTO specifications. The resistance factor of  $\phi = 0.80$  is consistent with the value used for lateral geotechnical stability under Extreme Events I and II.

General aspects of scour are described in Chapter 13 (Section 13.5), including definitions of the various components of scour and the interdisciplinary approach to addressing scour at bridges by hydraulic, structural, geotechnical, and civil engineers as presented in HEC-18 (Richardson and Davis, 2001). All of that information is applicable to scour associated with the check flood. Similarly, the methods described in Chapters 12 and 13 for calculating specific components of drilled shaft resistances under scour are also applicable to extreme event scour under the check flood. This includes assuming all material above the total scour line is removed and unavailable for axial or lateral support. Changes in subsurface stress that occur in response to scour, and the resulting effects on side resistance, are described in Section 13.5.5.

When evaluating extreme event limit states for earthquake and impact (Extreme Event Cases I and II), it is reasonable to account for the possibility of these events occurring in combination with scour. AASHTO (2007a) does not address the combination of scour and other extreme events. However, NCHRP Report 489 (Ghosn et al., 2003) provides some guidance on this topic. Recommendations based on the NCHRP report are presented in the final section of this chapter (Section 15.4).

## 15.2 DESIGN FOR EARTHQUAKE

Design of bridges and other transportation structures to withstand the effects of earthquakes is a major challenge. When considered in detail, the response of the total system consisting of seismically generated ground motions, structural foundations, and superstructure, is complex. Seismic ground motions are transmitted to the superstructure through kinematic interaction with the foundations. The superstructure mass is accelerated, resulting in the generation of inertial forces. The inertial forces must be transmitted back through the foundations and to the ground. A rigorous analysis of the complex interaction between the earthquake-induced ground motions, the foundations, and the structure is not practical for most bridges, although it is necessary under some conditions. For routine design of bridges, simplified pseudo-static methods of analysis and less complex dynamic response spectral analysis methods have been developed and these methods are summarized herein for application to design of drilled shafts. More complex rigorous methods are outlined in the references cited below:

FHWA-NHI-99-012	Geotechnical Earthquake Engineering Reference Manual	Kavazanjian et al. (1998)
FHWA/RD-86-101, 102, and 103	Seismic Design of Highway Bridge Foundations, 3 Volumes	Lam and Martin (1986)
NCHRP Report 472	Comprehensive Specification for The Seismic Design of Bridges	ATC/MCEER Joint Venture (2002)

### 15.2.1 Framework for Analysis of Earthquake Effects

The focus of this manual is on the structural and geotechnical information needed to establish loads and resistances of drilled shafts under earthquake effects, in accordance with current AASHTO LRFD Bridge Design Specifications. The current specifications (AASHTO, 2007a) address earthquake effects in several sections, including Chapter 3 (Loads), Chapter 4 (Structural Analysis), and Chapter 10

(Foundations). In 2007, two documents were approved by AASHTO that significantly change the specifications. The first is “Updated Seismic Provisions to LRFD Specifications” (AASHTO, 2007b). This update changes the return period of the design earthquake from 500 years to 1,000 years. The change in return period necessitates the use of updated maps for selecting seismic accelerations and a revised classification system for evaluation of subsurface site conditions. These updates allow for an improved spectral shape for determination of the seismic response coefficient.

The second approved document is “Guide Specifications for LRFD Seismic Bridge Design” (AASHTO, 2007c). These Guide Specifications are an alternate, stand-alone set of provisions for the seismic design of highway bridges. The major difference between these provisions and those in the update (above) is the methodology used for determining design forces. Elastic methods of analysis are used to calculate earthquake demands, but if these demands exceed the elastic strength (implicit capacity) of the columns, a nonlinear static analysis (a ‘pushover’ analysis) must be used, as a minimum, to determine design forces. The pushover analysis method explicitly models various displacement limit states and calculates member and component forces at each limit state, including collapse if required. Design forces at the earthquake displacement, calculated using the design response spectrum, can be found using the same pushover curve. Since the methodology focuses on displacements, it is often referred to as ‘displacement-based’. By contrast, the current LRFD Specifications (including the updates) are ‘force-based’. The Guide Specifications (AASHTO, 2007c) also adopt the same 1,000 year return period for the design earthquake as the updated provisions (AASHTO, 2007b). In this manual, primary emphasis is on the updated 2007 seismic provisions. Aspects of the Guide Specifications relevant to drilled shafts are also discussed, and major differences between the updated and Guide specifications are identified in Section 15.2.4.

### 15.2.1.1 Equivalent Static Analysis by AASHTO Specifications

The updated seismic provisions (AASHTO, 2007b) are applicable to “bridges of conventional slab, beam girder, box girder, and truss superstructure construction with spans not exceeding 500 ft.” Bridges with spans exceeding 500 ft or of other types of construction require Owner-specified provisions.

The AASHTO method for establishing the nominal seismic loads acting on the superstructure is a “force-based approach”. That is, the *force* generated on the superstructure in response to earthquake-induced ground shaking is taken as the product of *mass* and *acceleration*. This calculation is implemented as follows:

$$P_e(x) = C_{sm} W \quad 15-1$$

Where:

- $P_e(x)$  = Equivalent static horizontal seismic force acting on the superstructure
- $C_{sm}$  = Elastic seismic response coefficient (dimensionless)
- $W$  = Equivalent weight of the superstructure

Design loads transmitted to the foundations are then determined by structural analysis of the bridge model subjected to Extreme Event Load Combination I, which includes the seismic force effects by Equation 15-1 (denoted by *EQ*) plus permanent load, live load, water load, and friction.

The seismic hazard, design ground motions, and site response are taken into account through the single dimensionless coefficient,  $C_{sm}$ .  $C_{sm}$  is determined by constructing a *design response spectrum*, a graphical representation of  $C_{sm}$  versus the period of vibration. The response spectrum is determined as a function of the expected peak horizontal ground acceleration (*PGA*), the short-period spectral acceleration

coefficient ( $S_s$ ), the long-period spectral acceleration coefficient ( $S_l$ ), the site conditions, and the vibration period of the bridge. The peak acceleration coefficients given by AASHTO correspond to a 7 percent probability that the horizontal acceleration will be exceeded during a 75-year period. This corresponds to an earthquake with a return period of approximately 1,000 years.

The overall procedure used to evaluate earthquake force effects on drilled shaft foundations is summarized in the flowchart of Figure 15-1, which consists of four general steps. These steps are outlined in the following discussion. The purpose of this summary is to provide bridge and foundation engineers with a common framework for evaluating earthquake effects on drilled shafts. Most of the steps outlined below are carried out by the project structural engineer, but with input on geotechnical site characteristics which are provided by geo-professionals.

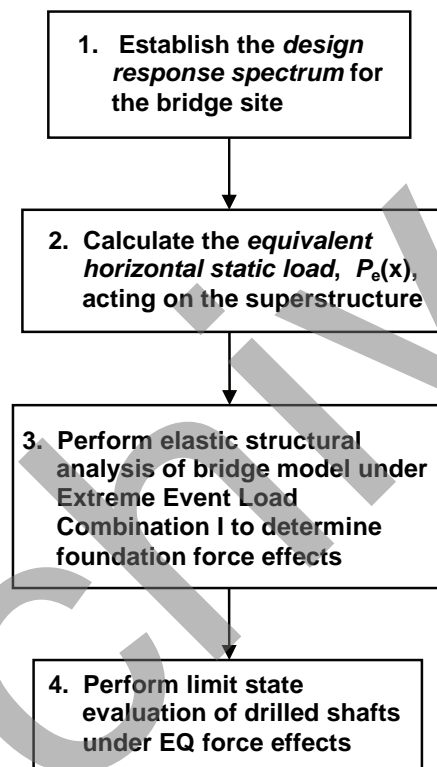


Figure 15-1 Flowchart of Major Steps for Analysis of Drilled Shafts for Earthquake Effects

### Step 1. Establish the Design Response Spectrum

The horizontal peak ground acceleration coefficient,  $PGA$ , is determined on the basis of site location from published contour maps of the United States. The coefficient is given as a percentage of acceleration due to gravity. Values of the short-period and long-period spectral acceleration coefficients ( $S_s$  and  $S_l$ ) are also determined from published contour maps. The published maps, as well as a software tool for developing the design response spectrum, were developed for AASHTO by the U.S. Geological Survey and are available on the following website: <http://earthquake.usgs.gov/research/hazmaps/design/> (USGS, 2010). The coefficients are given on the basis of the latitude and longitude of the bridge site, or by the zip code of the site. In lieu of the national ground motion maps for determination of the spectral coefficients, approved state ground motion maps may be used.

The subsurface profile is assigned to one of six classes (A through F) on the basis of stiffness as determined by the average shear wave velocity in the upper 100 ft of the ground profile. Alternatively, SPT N-values or undrained shear strengths of cohesive soils may be used to classify sites as indicated in Figure 15-1. AASHTO (2007b) provides equations for calculating weighted average values of shear wave velocity, N-value, and undrained shear strength.

Site Factors ( $F_{pga}$ ,  $F_a$ , and  $F_v$ ) are determined on the basis of Site Class (A through F) and the spectral response parameters  $PGA$ ,  $S_s$ , and  $S_1$ , as given in Table 15-2.

**TABLE 15-1 SEISMIC SITE CLASSIFICATION BASED ON SUBSURFACE PROFILE**

Site Class	Soil Type and Profile	$V_s$ (ft/sec)	SPT N-Value	$s_u$ (ksf)	Additional Criteria
A	Hard rock	> 5,000			
B	Rock	2,500 – 5,000			
C	Very dense soil and soil rock	1,200 – 2,500	> 50	> 2.0	
D	Stiff soil profile	600 – 1,200	15 - 50	1.0 – 2.0	
E	Soil profile	< 600	< 15	< 1.0	> 10 ft of soft clay <sup>(1)</sup>
F	Soil profiles requiring site-specific evaluation	> 10 ft of peat or highly organic clays (OH) > 25 ft of high plasticity clay (PI > 75) > 120 ft of soft-medium stiff clay			

$V_s$  = average shear wave velocity, upper 100 ft of the subsurface profile

N = average SPT N-value (blows/ft), upper 100 ft of the subsurface profile

$s_u$  = average undrained shear strength, upper 100 ft of subsurface profile

(1) soft clay defined as soil with PI > 20,  $w\%$  > 40, and  $s_u$  < 0.5 ksf

**TABLE 15-2 SEISMIC SITE FACTORS (after AASHTO, 2007b)**

Site Class	Site Factor $F_{pga}$					Short-Period Site Factor, $F_a$					Long-Period Site Factor, $F_v$				
	Value of Peak Ground Acceleration Coefficient (PGA) <sup>(1)</sup>					Value of Spectral Acceleration Coefficient at 0.2 seconds ( $S_s$ ) <sup>(1)</sup>					Value of Spectral Acceleration Coefficient at 1.0 seconds ( $S_1$ ) <sup>(1)</sup>				
	≤ 0.10	0.2	0.3	0.4	≥ 0.5	≤ 0.25	0.50	0.75	1.00	≥ 1.25	≤ 0.10	0.2	0.3	0.4	≥ 0.5
A	0.8	0.8	0.8	0.8	0.8	0.8	0.8	0.8	0.8	0.8	0.8	0.8	0.8	0.8	0.8
B	1.0	1.0	1.0	1.0	1.0	1.0	1.0	1.0	1.0	1.0	1.0	1.0	1.0	1.0	1.0
C	1.2	1.2	1.1	1.0	1.0	1.2	1.2	1.1	1.0	1.0	1.7	1.6	1.5	1.4	1.3
D	1.6	1.4	1.2	1.1	1.0	1.6	1.4	1.2	1.1	1.0	2.4	2.0	1.8	1.6	1.5
E	2.5	1.7	1.2	0.9	0.9	2.5	1.7	1.2	0.9	0.9	3.5	3.2	2.8	2.4	2.4
F <sup>(2)</sup>	*	*	*	*	*	*	*	*	*	*	*	*	*	*	*

<sup>(1)</sup> Use straight-line interpolation for intermediate values of PGA,  $S_s$ , and  $S_1$

<sup>(2)</sup> Site specific geotechnical investigation and dynamic site response analysis should be performed for all sites in Class F

The design response spectrum is constructed on the basis of three points defined by the parameters  $PGA$ ,  $S_s$ , and  $S_1$  and scaled using the Site Factors  $F_{pga}$ ,  $F_a$ , and  $F_v$ , as illustrated in Figure 15-2. A ground motion software tool is also available at the USGS website noted above. The software allows the user to perform all of the steps given above, including generation of the design response spectrum.

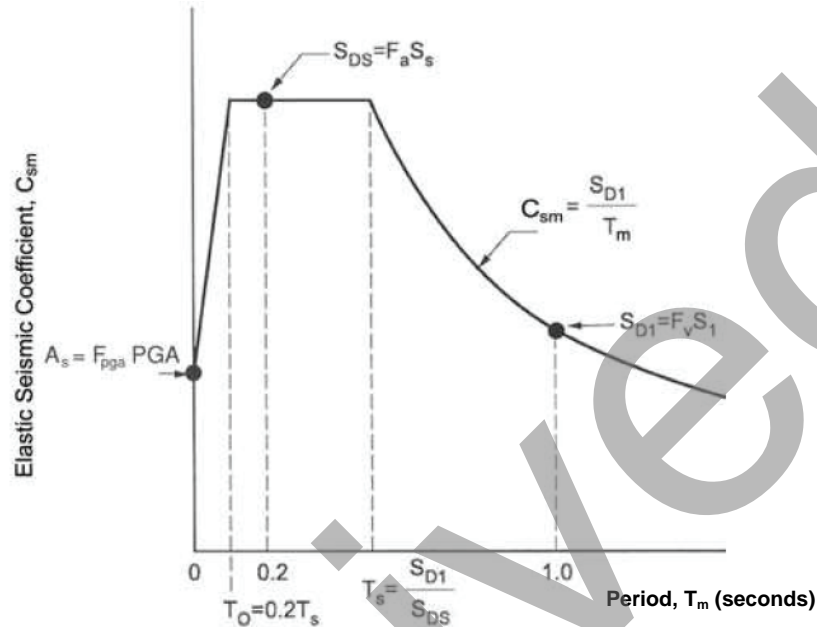


Figure 15-2 Response Spectrum for Determination of Seismic Response Coefficient (AASHTO, 2007b)

The procedure described above, based on national ground motion maps, is a general approach applicable to most sites. For sites that satisfy any of the following conditions, a site-specific analysis is required to develop the design response spectrum: (i) site is within 6 miles of an active fault; (ii) site conditions are determined to be Class F; (iii) long-duration earthquakes are expected in the region; or (iv) the importance of the bridge is such that a lower probability of exceedance (longer return period) should be considered. Detailed procedures for constructing a site-specific response spectrum are beyond the scope of this manual and the reader is referred to AASHTO (2007b) for general guidelines.

## Step 2. Calculate the Equivalent Horizontal Static Load, $P_e(x)$ , Acting on the Superstructure

Determine the period of vibration,  $T_m$  (seconds), for the  $m^{\text{th}}$  vibration mode of the bridge. This determination is carried out by the structural engineer and should be based on the nominal, unfactored mass of the structure.

The elastic seismic response coefficient is then calculated by:

$$C_{sm} = A_s + (S_{DS} - A_s) \frac{T_m}{T_o} \quad 15-2$$

in which all of the terms are associated with the design response spectrum (Figure 15-2) and are defined as follows:

- $A_s$  = value of  $C_{sm}$  corresponding to a period of zero seconds =  $F_{pga}$ (PGA)
- $S_{DS}$  = maximum value of  $C_{sm}$ , corresponding to a period of 0.2 seconds =  $F_A S_s$
- $T_m$  = period of vibration for the  $m^{\text{th}}$  mode of vibration (seconds)
- $T_o$  = reference period used to define spectral shape =  $0.2T_s$  (seconds)
- $T_s$  =  $S_{D1}/S_{DS}$  (seconds)
- $S_{D1}$  = value of  $C_{sm}$  corresponding to a period of 1 second =  $F_v S_1$
- $S_{DS}$  = value of  $C_{sm}$  corresponding to a period of 0.2 seconds =  $F_a S_s$
- $F_{pga}, F_v, F_a$  = seismic site factors as shown on Table 15-2
- $S_s$  = short-period (0.2 seconds) spectral acceleration coefficient
- $S_1$  = long-period (1 second) spectral acceleration coefficient

The equivalent static force and its distribution on the superstructure,  $P_e(x)$ , are then calculated by the structural engineer using one of three methods described in Article 4.7.4.3 of the AASHTO Specifications (2007a). These methods are: (1) single-mode spectral method, (2) uniform load method, and (3) multi-mode spectral method. Refer to AASHTO (2007a) for the detailed calculations associated with each of these methods. The seismic force  $P_e(x)$  is assumed to act in any lateral direction.

### Step 3. Structural Analysis

Based on the scaled acceleration coefficient  $S_{D1}$  the bridge is assigned to one of four seismic zones in accordance with Table 15-3. The zone designations reflect the variation in seismic risk in different areas of the U.S. and are used to permit different requirements for methods of analysis and design for earthquake effects. In general, seismic analysis is not required for bridges in Zone I or for single-span bridges regardless of seismic zone. However, the AASHTO provisions include minimum requirements for horizontal connection forces for Zone 1 bridges.

**TABLE 15-3 SEISMIC RISK ZONES**

Acceleration Coefficient	Seismic Zone
$S_{D1} \leq 0.15$	1
$0.15 \leq S_{D1} \leq 0.30$	2
$0.30 \leq S_{D1} \leq 0.50$	3
$0.50 < S_{D1}$	4

For bridges in Zones 2, 3, and 4, elastic structural analysis of the bridge is carried out under the Extreme Event Load Combination I. This load combination includes the permanent loads, live loads, water loads, and the seismic horizontal loading  $P_e(x)$  (see Table 10-3). Seismic load  $P_e(x)$  should be assumed to act in any lateral direction. The elastic seismic force effects on each of the principal axes of a component resulting from analyses in the two principal directions are then combined to form two load cases as follows: (1) 100 percent of the absolute value of the force effects in one of the directions combined with 30 percent of the absolute value of the force effects in the second direction, and (2) 100 percent of the absolute value of the force effects in the second direction combined with 30 percent of the absolute value of the force effects in the first direction. These analyses determine the resulting member force effects, including forces transmitted to the foundations. The case resulting in the largest force effect on the foundations is selected for design of the drilled shafts.

Modeling of the support conditions at the connection between the drilled shafts and the supported bridge may take several forms, both of which require the input of geotechnical engineers. One approach is to

establish a “depth of fixity” and model the bridge as being fixed at this depth. This approach is considered adequate for bridges in Seismic Zones 2 and 3, for sites classified as A, B, C, or D. The other approach is to model the foundation support through a set of equivalent linear springs to represent each degree of freedom. This method requires input from geotechnical engineers in order to select appropriate spring constants, most commonly based on  $p$ - $y$  analysis of trial designs to account for lateral and rotational spring coefficients, and  $t$ - $z$  analysis for vertical spring coefficients. Use of springs to model foundation lateral response is strongly recommended for bridges in Seismic Zone 4, for sites classified as E or F in Seismic Zones 2 and 3, and can be applied to any site.

Elastically computed force effects for substructure components and connections are divided by response modification factors ( $R$ -factors), as specified in Article 3.10.7 of AASHTO (2007b). Application of the  $R$ -factors, which are greater than 1.0, is based on the philosophy that it is uneconomical to design a bridge to resist large earthquakes elastically. Columns are assumed to deform inelastically, reducing the loads transmitted to substructure elements and connections. Seismic design forces for foundations (drilled shafts) are determined by using  $R$ -factors equal to one-half of the values specified in Article 3.10.7 for Seismic Zone 2, or  $R$ -factors equal to 1.0 for Seismic Zones 3 and 4 or for bridges classified as critical in Seismic Zone 2.

Design forces for foundations, including single drilled shafts or shaft-supported footings or caps, may be taken as the lesser of: (1) forces determined by elastic structural analysis of the bridge under Extreme Event Load Combination I, with the seismic force effects as determined above, or (2) the force effects at the base of the columns corresponding to column plastic hinging. Determination of inelastic hinging forces is presented in Article 3.10.9.4.3 of AASHTO (2007a).

#### **Step 4. Limit State Design of Drilled Shafts Under EQ Force Effects**

Force effects resulting from structural analysis (Step 3) are resolved into axial, lateral, and moment components at the top of each shaft. For groups with a cap, Section 14.6 discusses solutions for determining the force effects transmitted to each shaft in the group. Since the structural analysis of the bridge is carried out using factored loads under Extreme Event Load Combination I, the resulting calculated force effects acting on the foundations are factored.

The trial design is then checked against limit state criteria for axial and lateral loading. For lateral load and moment, the analysis is conducted in accordance with the methods presented in Chapter 12. A resistance factor of 0.80 is used for geotechnical lateral resistance, as discussed in Chapter 10. For axial loading, resistances are calculated by the methods presented in Section 13.3.5. A resistance factor of 1.0 is used for compression and a resistance factor of 0.8 is used for uplift of single drilled shafts.

#### **15.2.2 Time-History Analysis**

For bridges in Seismic Zone 4 classified as critical or for bridges that are geometrically complex or close to an active fault, AASHTO requires a step-by-step time-history structural analysis of the bridge. This more rigorous analysis requires development of a site-specific time history of the earthquake input accelerations. Structural models and analysis of the bridge may be elastic or inelastic and the most rigorous models account for coupled dynamic soil-structure interaction (SSI), including both kinematic and inertial effects and damping. For conventional highway bridges, a coupled 3-D analysis of the ground, deep foundations, and superstructure is generally not feasible. The approach usually adopted involves substructuring the analysis. Dynamic SSI analysis is conducted separately to determine foundation impedances. These impedances are then incorporated into the model of the superstructure as equivalent massless springs and the dynamic response of the structure is calculated using the site-specific



free-field ground motions (Wilson, 2004). Force effects on the foundations determined from the structural analysis are taken as the design loads applied at the top elevation of drilled shaft foundations.

Foundation design under the conditions described above is not standardized and the SSI analyses are normally carried out by specialists with in-depth knowledge of the numerical methods incorporated into the computer programs utilized for this purpose (for example, see Hadjian et al., 1992; Gazetas et al., 1992; Norris, 1994; Abghari and Chai, 1995). It is emphasized that while these more elaborate procedures may be warranted, they involve their own approximations and do not eliminate the uncertainties that are inherent in modeling of the soil-foundation-structure system, the specified ground motions, and material properties (Norris, 1994). An additional concern is that axial and lateral resistances of drilled shafts under earthquake cyclic loading may be affected (decreased) compared to resistances under static loading. General guidance on the effects of cyclic axial loading on side resistance of drilled shafts is given by McManus and Turner (1996). The interested reader is referred to the references cited above for further discussion of the issues and methods involved in seismic soil-foundation-structure interaction.

### 15.2.3 Effects of Liquefaction

In addition to the loads and deformations resulting directly from seismic ground motion, liquefaction at a bridge site may affect drilled shaft resistances and may cause secondary effects that impose additional loads. The following processes may require evaluation for their effects on drilled shaft performance:

#### Liquefaction.

Loss of shear strength and stiffness in saturated loose to medium dense cohesionless soil that results from a buildup of porewater pressure in response to cyclic shearing generated by seismic ground motions.

#### Lateral Spreading.

Lateral displacement of surficial blocks of soil as a result of liquefaction in a subsurface layer. Inertial forces generated by the earthquake combined with liquefaction may trigger a lateral spread, which may then continue under gravitational loads. Lateral spreading has been observed on slopes as gentle as 5 degrees.

#### Liquefaction-Induced Lateral Flow.

Lateral displacement of a slope that occurs under the combination of gravity load and excess porewater pressure (without inertial loading from earthquake). Lateral flow often occurs after the cessation of earthquake loading.

Direct and secondary effects of the processes defined above on drilled shaft foundations include:

- Temporary decreases in axial and lateral resistances over the depth(s) of embedment corresponding to liquefied soil layers
- Post-liquefaction settlement and the resulting downdrag on drilled shafts
- Horizontal forces imposed by soil undergoing lateral flow or lateral spread

Assessment of liquefaction potential is required by AASHTO (2007b) for sites in Seismic Zone 4. The first step is to identify soils that may be susceptible to liquefaction, generally saturated, loose to medium-dense sands and non-plastic silts, but also some gravelly and clayey soils. If it is determined that liquefaction-susceptible soils are present, procedures for assessment of liquefaction potential are carried

out. Simple empirical methods based on SPT and CPT tests (*e.g.*, Seed and Idriss, 1982) as well as analytical methods involving cyclic laboratory tests can be applied. These methods are presented in detail in Geotechnical Engineering Circular No. 3 (Kavazanjian et al., 1997) and in Appendix A10 of the AASHTO Specifications (2007a). The analyses account for expected ground accelerations and site conditions through the design response spectrum, which should be the same response spectrum used for structural analysis of the bridge and foundations.

If the assessment of liquefaction potential identifies subsurface zones where liquefaction is likely, the following principles will govern the design of drilled shaft foundations:

- Axial resistance is assumed to be zero in all geomaterials above the elevation corresponding to the greatest predicted depth of liquefaction, in accordance with Article 10.7.4 of AASHTO (2007b). Drilled shafts must, therefore, be sufficiently deep to develop adequate resistance in the geomaterials below the zone of liquefaction.
- Lateral resistance provided by soils that undergo liquefaction is assumed to be a lower-bound value corresponding to the liquefied state. This is based on the observation that saturated soils typically possess some “residual” shear strength even when in the liquefied state. Selection of  $p$ - $y$  curves should be based on soil strength properties corresponding to the liquefied state, which can be approximated by several methods, including: (1) cyclic laboratory shear tests that simulate liquefaction, or (2) empirically estimated residual shear strength from SPT  $N$ -values. 15-3 shows an empirical relationship given by Seed and Harder (1990) between the liquefied residual shear strength and  $N$ -values corrected for 60 percent hammer efficiency and overburden stress,  $(N_1)_{60}$ , and further corrected for percent fines, where:

$$(N_1)_{60-cs} = (N_1)_{60} - N_{corr} \quad 15-3$$

Additional discussion on the limitations and application of Equation 15-3 is given by Kavazanjian et al. (1997). Selection of  $p$ - $y$  curves for liquefied soil layers is covered in greater detail in Section 12.3.6 of this manual.

- Soil layers undergoing liquefaction and all soils layers above the zone of liquefaction are assumed to undergo settlement that may result in downdrag on drilled shafts. The magnitude of settlement can be approximated by procedures given by Tokimatsu and Seed (1987) and described in Kavazanjian et al (1997). The downdrag forces should be calculated using unit side resistance values corresponding to the residual (liquefied) shear strength in the zone of liquefaction (Figure 15-3). For geomaterial layers above the zone of liquefaction, downdrag forces should be based on side resistance values corresponding to a nonliquefied state. The resulting downdrag forces ( $DD$ ) are included as a component of the permanent loads in Extreme Event Load Combination I. The load factor for liquefaction-induced downdrag forces is 1.0. Downdrag forces associated with settlement by other causes (*e.g.*, consolidation) are not used in extreme event limit state analyses.

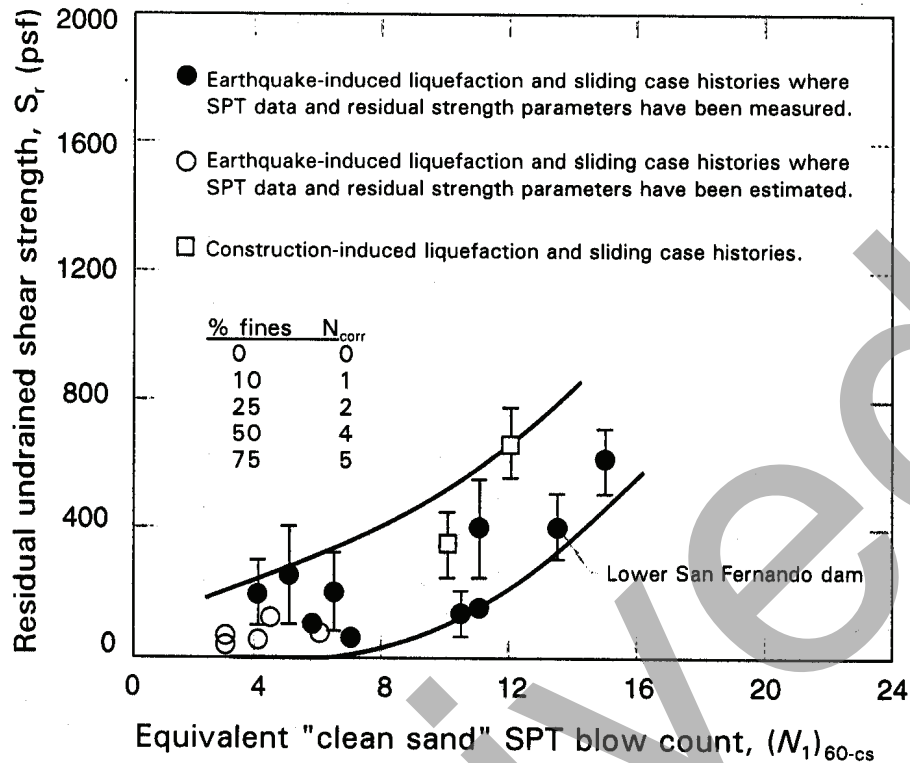


Figure 15-3 Relationship Between Corrected Blow Count and Undrained Residual Strength ( $S_r$ ) from Case Studies (Harder and Seed, 1990)

The AASHTO provision to account for liquefaction-induced downdrag as part of Extreme Event I loading is based on the assumption that settlement occurs during the earthquake. It may be more reasonable to assume that settlement and the resulting downdrag occur after the earthquake, as excess porewater pressures dissipate. In this case, post-liquefaction downdrag should be considered for strength and service limit states.

- If liquefaction and lateral flow or lateral spreading are predicted to occur for Seismic Zone 4, a detailed evaluation of the effects of lateral flow or lateral spreading on foundations should be performed. The approach involves four basic elements:
  1. A stability analysis, with residual strengths of soils in liquefied zones
  2. A Newmark sliding block analysis
  3. Assessments of the passive forces that can ultimately develop against the foundations as liquefaction induces lateral spread
  4. Assessment of the likely plastic mechanisms that may develop in the foundations and substructure.

The basic idea of this approach, as described in NCHRP Report 472 (ATC/MCEER Joint Venture, 2002), is to determine the expected magnitude of lateral soil movement and to assess the structure's ability to accommodate this movement or limit it. Also note that this approach allows the development of ultimate plastic rotation (hinging) in the drilled shafts, which implies the acceptance of foundation damage and

possibly the need for replacement or repair following the design earthquake. Design options range from (a) acceptance of the deformations with significant damage to the drilled shafts and columns if deformations are large, to (b) designing the shafts to resist the forces generated by lateral flow or spreading. Between these options are a range of mitigation measures to limit the amount of movement to tolerable levels for the desired performance objective. Analysis of drilled shafts subjected to lateral loading associated with liquefaction and lateral spread is addressed briefly in Section 12.3.3.5.2 of this manual.

#### 15.2.4 Discussion of the AASHTO Guide Specifications for LRFD Seismic Bridge Design

Bridge design for seismic loading can be conducted in accordance with the provisions in either the updated 2007 seismic specifications (AASHTO, 2007b) or the recently approved Guide Specifications (AASHTO, 2007c). As noted, the principal overall difference between the two sets of provisions is that the existing specification is a force-based approach, while the Guide Specifications employ a displacement-based approach. In terms of the analytical procedures, the differences relate mostly to structural analysis. The overall procedure encompasses a demand analysis and a displacement capacity verification. Structural modeling of the bridge is conducted to estimate the lateral displacement of each bridge bent under Extreme Event Load Combination I, referred to as the displacement “demand”,  $\Delta_D$ . The computed demand is compared to the displacement “capacity”,  $\Delta_C$ , which is the displacement at which the earthquake-resisting elements achieve their inelastic capacity, defined in most cases by plastic hinge rotation in individual elements of piers or bents. The design criterion in terms of displacements is that:

$$\Delta_D < \Delta_C$$

15-4

Structural components not participating as part of the primary energy dissipating system (*i.e.*, components other than the columns undergoing flexural hinging above ground) are designed to be “capacity protected” meaning that these members are designed to carry the maximum shear and moment from plastic hinging of the columns elastically. These components include the superstructure, joints and cap beams, spread footings, pile caps, and foundations. The objective of these provisions for conventional design is that inelastic by plastic hinges in the columns.

The Guide Specifications are more explicit in identifying earthquake resisting elements (ERE) that can be incorporated into bridge designs. The ERE’s are categorized as (i) permissible, (ii) permissible with Owner’s Approval, and (iii) not recommended. One of the ERE’s identified in category (ii) is in-ground hinging of piles and shafts. This represents an exception to the overall philosophy of restricting hinging to above-ground locations as described above. In this approach, some limited inelastic deformation is permitted below ground level. The amount of permissible deformation is restricted to ensure that no long-term serviceability problems occur from the amount of cracking that is permitted in the shaft. In addition, plastic deformation of drilled shafts is acceptable for design against liquefaction-induced lateral flow or lateral spreading, as described previously. Analysis that accounts for plastic deformation of drilled shafts requires close cooperation between geotechnical and structural engineers. The analysis is conducted using methods described in Chapter 12 for lateral loading, usually the p-y curve method, and must incorporate the nonlinear relationship between moment and flexural rigidity of the reinforced concrete shaft based on assumed cracking of the concrete.

The Guide Specifications define Seismic Design Categories (SDC), A through D, which correspond to Seismic Zones 1 through 4 in the current specifications. For normal bridges in SDC D (equivalent to Seismic Zone 4) an inelastic quasi-static pushover analysis (IQPA), commonly referred to simply as a “pushover” analysis, is required to determine reliable displacement capacities ( $\Delta_C$ ) of the structure and its

components. This procedure is a key element of the Guide Specifications because it provides additional information on expected deformation demands of columns and foundations. A structural model of the bridge is subjected to a static horizontal force which is applied incrementally. At each load increment, deformations and member forces are calculated. The analysis continues through inelastic stages, allowing the identification and location of plastic hinges in the structure. The analysis is carried through to structural collapse, allowing identification of collapse mechanisms and providing an improved understanding of bridge performance under seismic loading.

Modeling of support conditions at foundations for the purpose of structural modeling as specified in the Guide Specifications can involve several different approaches, which are basically the methods described previously in connection with the force-based approach. The Guide Specifications state that “the flexibility of a drilled shaft shall be represented using either the estimated depth of fixity or soil springs in a lateral pile analysis”. Soil springs are required for pushover analysis and bi-linear springs are recommended in the pushover analysis if there is particular concern with depth of the plastic hinge and effective depth of fixity. For essential or critical bridges in SDC D, nonlinear time-history analysis of the bridge is required. This provision is the same as given in the current specifications (AASHTO, 2007b) and is discussed in Section 15.6.3 of the specifications.

The Guide Specifications specify a load factor of  $\gamma_p = 1.0$  for all permanent loads in Extreme Event Load Combination I. The load factor for live load ( $\gamma_{EQ}$ ) can range from 0.0 to 0.5. It is usually taken as zero, except where heavy truck traffic, high average daily traffic, or long structure length are anticipated, in which case  $\gamma_{EQ}$  may be taken as 0.5. Additional discussion on differences between the current AASHTO Specifications (AASHTO, 2007a,b) and the Guide Specifications (2007c) is given in Buckle et al. (2006).

### 15.3 DESIGN FOR EFFECTS OF ICE AND COLLISIONS

Bridges may be designed to withstand the effects of ice, collision by vehicles, or collision by vessels such as ships or barges in navigable waterways. Each of these is considered as a separate loading case in the AASHTO Specifications (2007a) under Extreme Event Load Combination II. The procedures for calculating loads associated with these events do not require geotechnical input (unlike earthquake loading); therefore, no attempt will be made to present details of the methods, except to the extent necessary to understand the resulting force effects on drilled shaft foundations. Once the foundation force effects are determined, drilled shaft resistances are determined according to the methods given in Chapters 12 (Lateral), 13 (Axial), and 14 (Group) with appropriate resistance factors for extreme event loading.

#### 15.3.1 LRFD Framework for Extreme Event II

Extreme Event II addresses load combinations relating to ice load (*IC*) and collision by vehicles (*CT*) and vessels (*CV*). The other loads included in this combination are permanent loads (*DL*), live loads (*LL*), water load (*WA*), and friction (*FR*). As presented in Table 10-3, permanent load and live load each are comprised of several load sources. Table 10-3 also specifies the load factors for each component, leading to the following summation of factored loads for Extreme Event II:

$$\Sigma \gamma F = \gamma_p DL + 0.5 LL + 1.0 WA + 1.0 FR + 1.0[IC \text{ or } CT \text{ or } CV] \quad 15-5$$

in which values of  $\gamma_p$  for individual components of permanent load are given in Table 15-4. The last term in Equation 15-5 indicates that each of the three force effects (*IC*, *CT*, and *CV*) is considered separately (not combined) and that the load factor for these extreme events is 1.0.

Resistance factors for drilled shafts under extreme event load combinations, including design to resist ice or vehicle and vessel impact loads, are taken equal to 1.0, except for uplift, for which the resistance factor is taken as 0.80 or less, and for geotechnical lateral stability for which the resistance factor is 0.80.

### 15.3.2 Determination of Force Effects on Drilled Shafts

Three methods of structural analysis may be used by bridge engineers to determine the overall structural stability of a bridge and the member force effects under Extreme Event Load Combination II.

1. Linear elastic analysis with impact treated as an equivalent static force
2. Nonlinear inelastic analysis with impact treated as an equivalent static force
3. Dynamic analysis of the structure under a dynamic impact load, with elastic or inelastic response

#### Force Effects due to Ice Loads (*IC*)

Ice forces are assumed to act directly on bridge piers (substructure). Loads are analyzed as occurring due to one of the following actions: (1) dynamic forces that occur when a moving ice floe strikes a bridge pier, (2) static pressure due to thermal expansion of ice sheets, (3) pressure resulting from hanging dams or ice jams, and (4) static uplift force resulting from adhering ice in waters of fluctuating level. Equations for estimating the magnitude and location of ice forces acting on bridge piers are given in Section 3.9 of the AASHTO specifications (AASHTO, 2007a).

Dynamic forces computed in connection with impact by moving ice are generally used by structural engineers in a dynamic analysis of the bridge model. The structural designer may incorporate the dynamic response of the deep foundations supporting the pier into the structural analysis, because damping may be a critical parameter for predicting the pier (and bridge) response. It has been shown by Montgomery et al. (1980) that flexible piers and pier components (including foundations) may cause considerable amplification of dynamic ice forces due to resonant ice-structure interaction at low levels of structural damping. Drilled shafts can be used to advantage in this situation by providing relatively high flexural rigidity and higher damping than driven piles.

Loads caused by the action of items (2) and (3) above are treated as static lateral forces acting directly on bridge piers and are used by structural engineers in a static analysis of the bridge, from which the nominal force effects acting on individual structural members are determined. Lateral forces on a bridge pier will cause lateral and moment force effects at the head of drilled shafts and may also result in axial forces (compression and uplift) when transmitted to a drilled shaft-supported footing or cap.

Static vertical uplift forces can be transmitted to bridge piers, and possibly to sections of drilled shafts that extend above the mudline, by ice that adheres to the pier or shaft and then is subjected to rising water levels (sometimes referred to as “ice jacking”) For a circular pier or a drilled shaft, the vertical uplift force ( $F_v$ ) in kips can be estimated as:

$$F_v = 80.0t^2 \left( 0.35 + \frac{0.03R}{t^{0.75}} \right) \quad 15-6$$

where:

t = Ice thickness (ft)  
R = Radius of the pier or drilled shaft (ft)

The resulting force on the drilled shaft is treated as a static uplift load as a component of ice load (*IC*) with a load factor of 1.0, as part of Extreme Event Load Combination II.

Force Effects due to Vehicle Collision (*CT*)

This load case is applied only to bridges that are not crash-protected. Protection may be provided by an embankment or by crashworthy barriers located at least 10 ft from the component being protected. For bridge piers that are not protected, the potential effects of a collision by a truck or rail car are taken into account by applying an equivalent horizontal static force of 400 kips to the pier. For individual pier shafts, the 400 kip force is applied as a point load located 4 ft above the ground. For wall piers the load can be applied as a point load or distributed over an area deemed appropriate on the basis of the dimensions of the vehicle expected to collide and the dimensions of the structure, not to exceed 5 ft wide by 2 ft high. The force effects on drilled shaft foundations are calculated by static analysis of the structural model of the bridge with foundation support modeled by the “depth of fixity” or through the use of representative linear springs.

Force Effects due to Vessel Collision (*CV*)

A useful reference on this topic is the AASHTO Guide Specification and Commentary for Vessel Collision Design of Highway Bridges (AASHTO, 1991).

Collision of a ship or barge with a bridge can be a severe loading event and the possibility of bridge collapse is considered under this extreme event. The first step in analyzing a bridge for vessel collision is to select the design vessel to be used in calculating collision loads. The design vessel is determined by a risk assessment that involves analyzing the annual frequency of collapse for each pier or span component subject to collision. The analysis is probability-based and accounts for characteristics of the waterway, the bridge, and the types of vessels expected to use the waterway.

Once the design vessel is selected, loading caused by a vessel collision is evaluated in terms of the head-on impact force of the vessel on a pier, as illustrated in Figure 15-4, and given by:

$$P_s = 8.15V\sqrt{DWT} \quad 15-7$$

where:

$P_s$  = Equivalent static impact force (tons)  
 $V$  = Vessel impact velocity (ft/sec)  
 $DWT$  = Deadweight tonnage of the vessel (tons)

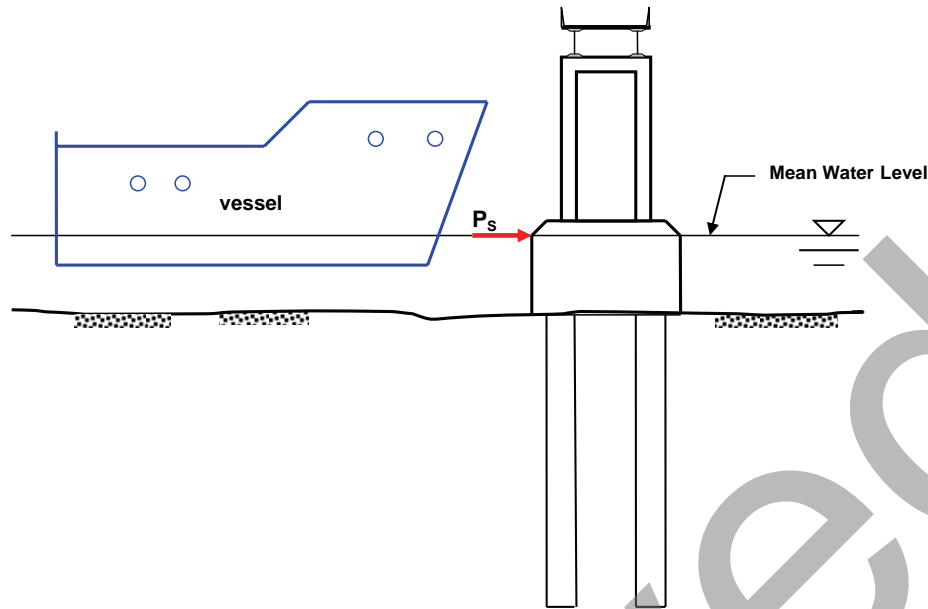


Figure 15-4 Design Impact Force, Ship Colliding with Bridge Pier

Force effects on structural components are then determined by static structural analysis of the bridge model. Two separate cases are analyzed: (1) 100 percent of the design impact force ( $P_s$ ) is applied to the pier in a direction parallel to the alignment of the channel, and (2) 50 percent of the design impact force is applied in the direction perpendicular to the centerline of the channel alignment. For each case, the load is applied according to the following criteria. For overall stability, the design impact force is applied as a concentrated force on the substructure at the elevation of mean high water level, as shown in Figure 15-4. To evaluate local collision forces, the design impact force is applied as a vertical line load distributed uniformly over the length of the ship's bow. Foundations are designed for the force effects calculated for all of the above load cases, and the most critical case governs the final design. A similar analysis is conducted for the case of a barge colliding with a bridge pier (substructure).

Ship collision may also occur against exposed portions of a bridge superstructure. Several potential superstructure loading cases are considered by AASHTO, including impact by the bow, the deck house, and the mast of the ship. In each case, the resulting equivalent horizontal static force is expressed as a function of  $P_s$ , as given by Equation 15-7, and various modification factors as given in Article 3.14.10 of the AASHTO Specifications (2007a). The resulting force effects transmitted to the foundations are determined by structural analysis of the bridge model. In the structural model, the design impact force is applied as an equivalent static force transverse to the impacted superstructure component in a direction parallel to the alignment of the centerline of the navigable channel.

In most cases, structural designers will analyze the force effects of vessel impact by static structural analysis of the bridge model. AASHTO Specifications (2007a) provide the designer with the option of designing the bridge to withstand the effects of collision in either elastic or inelastic manner. If the structural response is assumed to be inelastic, then inelastic behavior and redistribution of forces is permitted in superstructure and substructure components, provided the structure possesses sufficient ductility and redundancy to prevent collapse. Presumably, this provision allows plastic hinging in drilled shaft foundations, similar to provisions for earthquake loading as described previously. If drilled shafts are designed for inelastic response by development of plastic hinging, the geotechnical and structural engineers must work together closely to develop appropriate soil-structure interaction models that predict



the location of plastic hinging. The methods described in Chapter 12 for lateral loading response, such as the  $p$ - $y$  curve method, would typically be used for this purpose.

On very large or critical bridges, or for very large vessels, a dynamic structural model may be used to evaluate the effects of vessel collision and the resulting force effects on drilled shaft foundations. In these cases, the dynamic response of the foundations may be required to establish appropriate spring and damping coefficients for representation of the foundations in the structural model. Detailed description of dynamic soil-structure interaction is beyond the scope of the manual and the reader is referred to Hadjian et al. (1992) and Wilson (2004) for additional guidance.

#### 15.4 DESIGN FOR COMBINED EXTREME EVENTS

NCHRP Report 489 (Ghosn et al., 2003) describes a study of the various combinations of extreme events applicable to bridge design. The authors make several recommendations for updating the AASHTO LRFD Bridge Design Specifications. Although not adopted by AASHTO at the time of this writing (2009), the recommendations provide a rational framework for design of drilled shafts under combined extreme events, in particular for addressing scour in combination with other extreme events.

Ghosn et al. (2003) proposed four new Extreme Event limit states for design of bridges. The proposed limit states and associated load combinations are presented in Table 15-4.

**TABLE 15-4 LOAD COMBINATIONS AND LOAD FACTORS FOR EXTREME EVENT LIMIT STATES PROPOSED BY GHOSN ET AL. (2003)**

Load Combination  Limit State	$PL$	$LL$	$WA$	$WS$	$WL$	$FR$	$TCS$	$TG$	$SE$	Use one of these at a time				$SC^{(1)}$
										$EQ$	$IC$	$CT$	$CV$	
Extreme Event III	$\gamma_p$	1.75	1.00	-	-	1.00	-	$\gamma_{TG}$	$\gamma_{SE}$	-	-	-	-	1.80
Extreme Event IV	$\gamma_p$	-	1.00	1.40	-	1.00	-	$\gamma_{TG}$	$\gamma_{SE}$	-	-	-	-	0.70
Extreme Event V	$\gamma_p$	-	1.00	-	-	1.00	-	-	-	-	1.00	1.00	1.00	0.60
Extreme Event VI	$\gamma_p$	-	1.00	-	-	1.00	-	-	-	1.00	-	-	-	0.25

- $PL$  permanent load
- $LL$  live load
- $WA$  water load and stream pressure
- $WS$  wind load on structure
- $WL$  wind on live load
- $\gamma_p$  load factor for permanent loads
- $\gamma_{SE}$  load factor for settlement (see AASHTO 2007 Article 3.4.1)
- $\gamma_{TG}$  load factor for temperature gradient (see AASHTO 2007 Article 3.4.1)
- (1) Values listed are multipliers to be applied to the total scour depth associated with the design (100-year) flood.
- $FR$  friction
- $TG$  temperature gradient
- $SE$  settlement
- $EQ$  earthquake
- $TCS$  uniform temperature, creep, and shrinkage
- $IC$  ice load
- $CT$  vehicular collision force
- $CV$  vessel collision force
- $SC$  scour

This table is similar in format to Table 10-3, except for an additional column on the far right. This column is labeled ‘ $SC$ ’ for scour. The values in this column are multipliers to be applied to the total scour depth associated with the *design* flood (100-year flood). The four proposed limit states are described as follows:

- Extreme Event III: Load combination relating to live load and scour
- Extreme Event IV: Load combination relating to wind loads in the presence of scour
- Extreme Event V: Load combination relating to ice load, collision by vessels or vehicles in the presence of scour
- Extreme Event VI: Load combination relating to earthquakes with scour

Force effects on the drilled shaft foundations are determined through structural modeling of the bridge under the load combinations given in Table 15-4 and in accordance with the methods described in the previous sections of this chapter for earthquake, ice, and collision. Resistance factors for drilled shafts under all extreme event load combinations are taken equal to 1.0, except for uplift, for which the resistance factor is taken as 0.80 or less, and for geotechnical lateral stability for which the resistance factor is 0.80.

The approach described above for combining extreme events is recommended as a preliminary guideline until more definitive AASHTO specifications are developed.

## 15.5 SUMMARY

The basic framework for design of drilled shafts under various extreme events is outlined. Design of drilled shafts for the extreme event scour, associated with the 500-yr flood event (the check flood), must account for the decrease in side and lateral resistances resulting from the removal of soils, and possible changes in force effects resulting from an increase in the unsupported length of pier columns and foundations. Design for earthquake and vehicle or vessel impact is dictated by the force effects generated by seismic or impact loads applied to the bridge or other structure. The processes used by bridge structural designers to determine seismic and impact forces are summarized. The resulting force effects transmitted to the foundations can, in some cases, be extremely large and may control the design of drilled shafts.

Resistance factors used for drilled shaft design under extreme event limit states are generally taken as 1.0, except for uplift and lateral geotechnical strength, in which case the resistance factors are 0.80.

## CHAPTER 16

### STRUCTURAL DESIGN

#### 16.1 INTRODUCTION

This chapter describes the process for structural design of drilled shafts. The methods are generally in accordance with the AASHTO LRFD 2007 Bridge Design Specifications (AASHTO, 2007a), with 2009 Interims.

As discussed in Chapter 11, structural design of drilled shaft foundations (Block 12 of Figure 11-1) is not a linear process, as might be implied by the simplified format of Figure 11-1. The complete structural design typically requires numerous iterations in order to achieve an optimal design (adjusting shaft diameter, length, group configuration, etc.), or to accommodate constructability concerns. A flow chart expanding from Block 12 of Figure 11-1 is shown on Figure 16-1 to outline the structural design sequence.

The following points are important with regard to the material presented in this chapter.

1. Drilled shafts are treated as reinforced-concrete beam-columns for structural design purposes.
2. The position taken in this manual is to require a minimum reinforcement because of the potential for unforeseen loading (tension or flexure due to wind loads, uplift due to expansive clay, and similar loadings).
3. The methods presented herein are based on the load and resistance factor design (LRFD) procedure that was first described in Chapter 10.
4. Some of the requirements for minimum amounts of steel reinforcement depend upon the location of the section being analyzed relative to: (a) the depth at which the shaft is 'laterally supported' and (b) the depth of 'moment fixity'. AASHTO (2007), Section C.10.8.3.9.3, defines laterally supported as:
  - Below the zone of liquefaction or seismic loads,
  - In rock, or
  - 5.0 ft below the ground surface or the lowest anticipated scour elevation

As stated in C.10.8.3.9.3: "Laterally supported does not mean fixed. Fixity would occur somewhat below this location and depends on the stiffness of the supporting soil". The depth of moment fixity is not defined in AASHTO (2007) Specifications. A working definition of moment fixity found to be useful by the authors is: the depth below which the moment is equal to or less than 5 percent of the maximum moment in the shaft. The distribution of moment as a function of shaft depth would be determined through analysis of the shaft under lateral or moment loading, for example by the p-y method of analysis described in Chapter 12.

Readers can refer to textbooks (Ferguson, 1988; Wang and Salmon, 1985) for detailed information on design of reinforced concrete beam-columns.

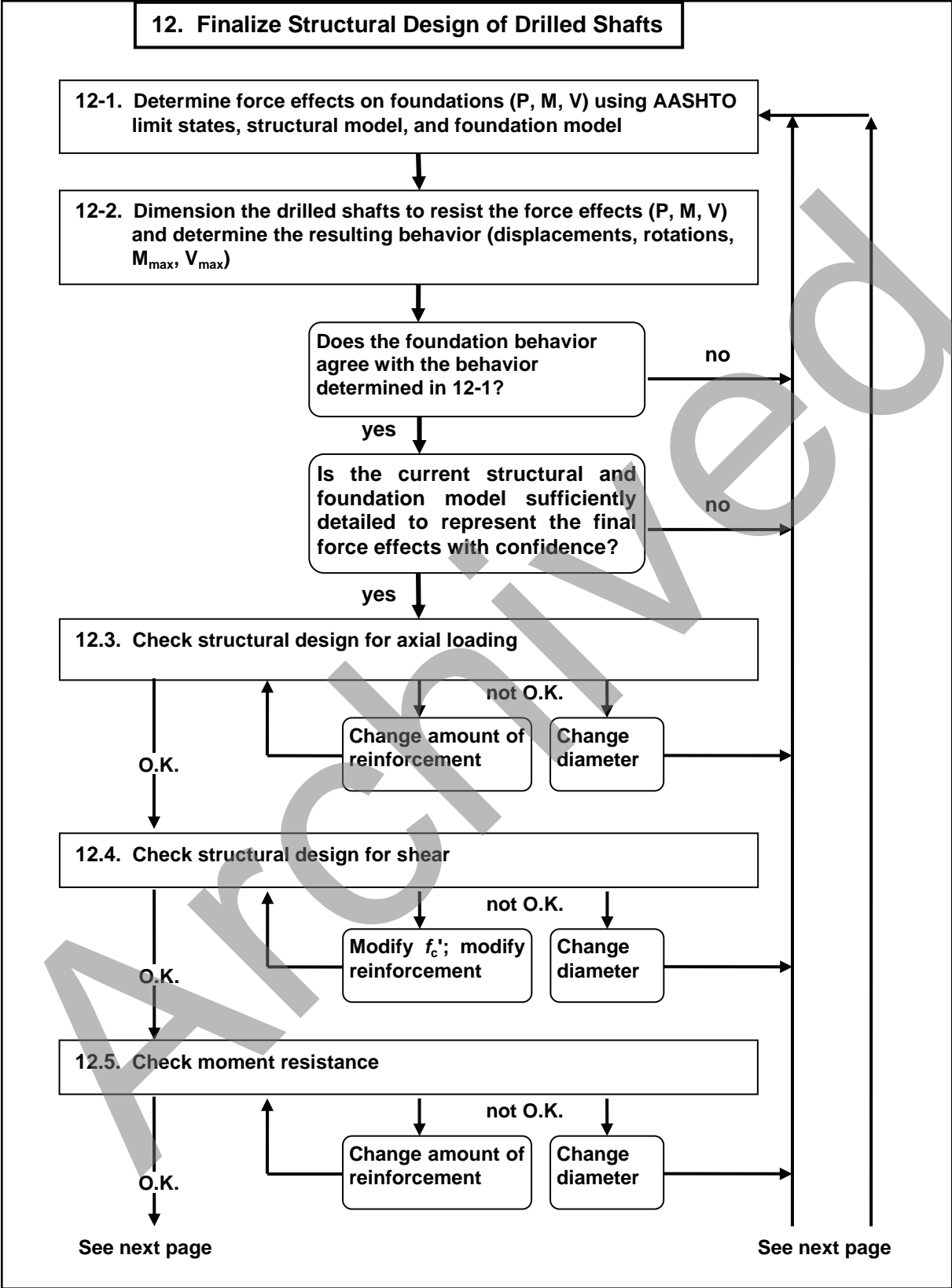


Figure 16-1 Flow Chart for Structural Design

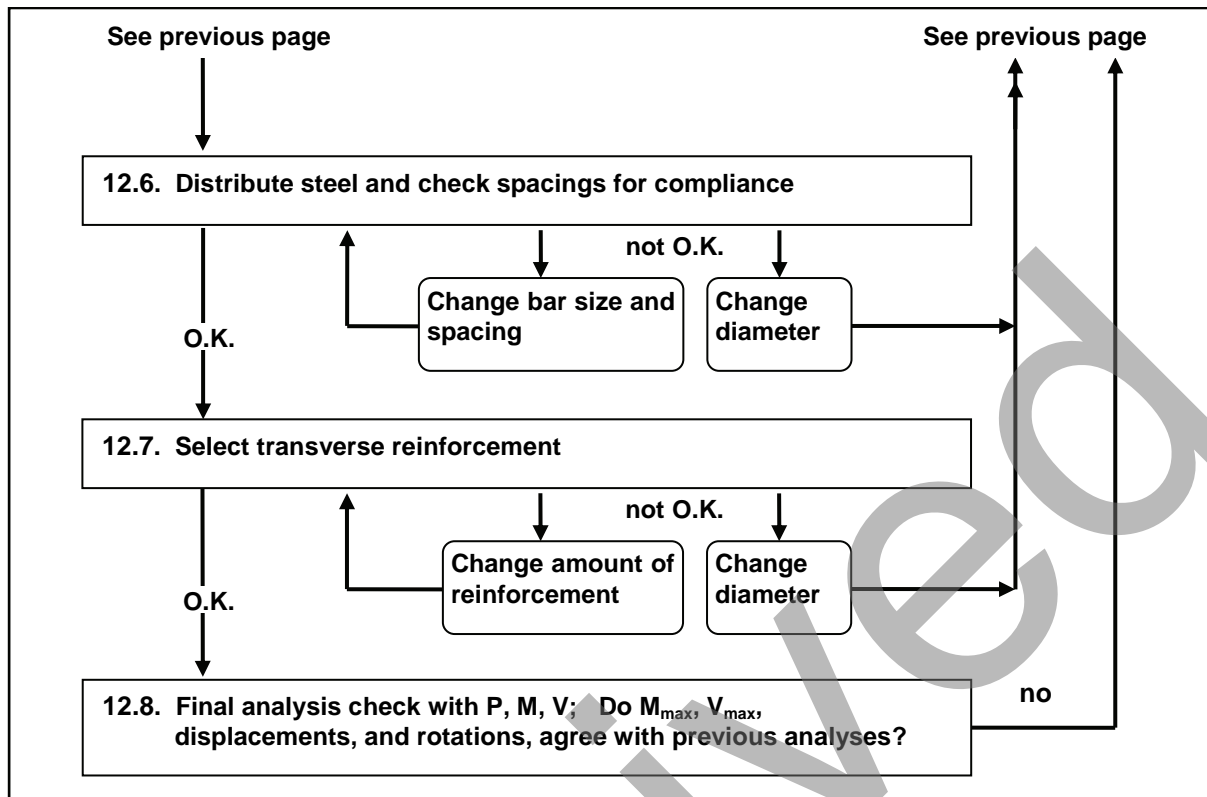


Figure 16-1 Flow Chart for Structural Design (Continued)

## 16.2 MATERIAL PROPERTIES

Structural materials including concrete, reinforcing steel, and casings are discussed previously (*i.e.* Chapters 6, 8, and 9). Unless otherwise noted, materials and material properties should be in accordance with the provisions of the current AASHTO LRFD Specifications (2007). Structural considerations of these material properties are discussed hereafter.

### 16.2.1 Concrete

Drilled shafts are generally designed with concrete having a specified compressive strength,  $f'_c$ , of 3.5 ksi to 5.0 ksi. Note that AASHTO (5.4.2.1) prohibits the use of concrete with a specified compressive strength less than 2.4 ksi for structural applications (including drilled shafts).

Concrete for drilled shafts shall be normal weight. The modulus of elasticity for concrete,  $E_c$ , can be approximated by Equation 16-1:

$$E_c = 1820\sqrt{f'_c} \quad (\text{AASHTO C5.4.2.4.-1}) \quad 16-1$$

Refer to AASHTO 5.4.2 and Chapter 9 of this manual for additional requirements for drilled shaft concrete.

### 16.2.2 Reinforcing Steel

Reinforcing steel for drilled shafts will generally be AASHTO M31 (ASTM A615) Grade 60, with a minimum yield strength of 60 ksi. The use of reinforcing steel with yield strengths less than 60 ksi is not recommended. Bars with yield strengths less than 60 ksi should be used only with the approval of the owner.

The use of reinforcing steel conforming to ASTM A706, “Low Alloy Steel Deformed Bars for Concrete Reinforcement”, should be considered where improved ductility is needed or where welding is required.

The modulus of elasticity,  $E_s$ , for reinforcing steel can be assumed to be 29,000 ksi.

Refer to AASHTO 5.4.3 and Section 8.3 of this manual for additional information on drilled shaft reinforcing steel.

### 16.2.3 Casings

Steel for permanent casings should generally conform to the values shown in Table 16-1.

**TABLE 16-1 MINIMUM YIELD STRENGTHS FOR PERMANENT STEEL CASING**

<b>Standard</b>	<b>Minimum Yield Strength (<math>f_y</math>)</b>
ASTM A36	36 ksi
ASTM A242	50 ksi for thickness $\leq 1/2$ " 46 ksi for $3/4$ " < thickness $\leq 1 1/2$ " 42 ksi for $1 1/2$ " < thickness $\leq 4$ "
ASTM A252 Grade 2	36 ksi
ASTM A252 Grade 3	45 ksi

The modulus of elasticity,  $E$ , for steel casings can be assumed to be 29,000 ksi.

The thickness of casings should be shown in the contract documents as “minimum”. The minimum thickness of casings should be that required for reinforcement or for strength required during driving. The latter is a function of both the site conditions and the driving equipment. AASHTO Specifications (2007) require the contractor to furnish casings of greater than the design minimum thickness, if necessary, to accommodate the contractor’s choice of driving equipment. Readers are referred to Chapter 6 for more information on this topic.

### 16.3 MINIMUM AND MAXIMUM AMOUNT OF LONGITUDINAL STEEL REINFORCEMENT

AASHTO (5.7.4.2) specifies a range for the amount of steel reinforcement allowed in the cross-section of a drilled shaft. The maximum allowable area of longitudinal reinforcing steel,  $A_s$ , is 8.0% of the gross cross-sectional area of the shaft  $A_g$ , or:

$$\frac{A_s}{A_g} \leq 0.08 \quad (\text{AASHTO 5.7.4.2-1}) \quad 16-2$$

In addition, AASHTO (5.10.11.3 and 5.10.11.4.1) limits the longitudinal reinforcement for Seismic Zones 2, 3 and 4 to not more than 6.0%. Typical amounts of reinforcement are between one and two percent but may be greater than 3% in high seismic zones. Construction of drilled shafts with longitudinal reinforcement greater than 4% is difficult, and should be avoided if at all possible. Difficulties with construction of drilled shafts with the higher percentages of longitudinal reinforcement include the flow of concrete through the rebar cage to the outside faces of the shaft.

The minimum amount of longitudinal reinforcement is affected by both the strength of steel and concrete. In the portions of the drilled shaft that behave as a column, defined as any portion of the shaft above the depth at which the shaft is laterally supported (defined on page 16-1), the minimum longitudinal reinforcement amount is determined as:

$$\frac{A_s f_y}{A_g f_c} \geq 0.135 \quad (\text{AASHTO 5.7.4.2-3}) \quad 16-3$$

In which  $f_y$  = yield strength of the longitudinal steel bars. Furthermore, the minimum longitudinal reinforcement area in the portions of the shaft that behave as a column should be not less than 1% of the gross concrete area of the shaft. Below the section where the drilled shaft behaves as a column (*i.e.*, is laterally supported) nominal longitudinal reinforcement may be provided. However, 0.5% of the gross concrete area of the pile is suggested as a practical minimum.

The longitudinal reinforcing bars should be evenly distributed among not less than 6 bars in a circular arrangement. The minimum size of longitudinal bars is No. 5 (AASHTO 5.7.4.2).

Per AASHTO 5.13.4.5.2, the clear distance between parallel longitudinal reinforcing bars shall be not less than 5 times the maximum aggregate size or 5.0 inches, whichever is greater. However, recent research has indicated that, for drilled shafts constructed using tremie concrete, the proper flow of concrete through the rebar cage cannot be assured unless the clear spacing is equal to or greater than 10 times the maximum aggregate size. When necessary, vertical reinforcing bars should be bundled in order to maximize the clear space between vertical reinforcement bars. For drilled shafts constructed by the dry method, a clear spacing of 5 times the maximum aggregate size, with a minimum of 5.0 inches, is sufficient.

#### 16.4 MINIMUM AMOUNT OF TRANSVERSE STEEL REINFORCEMENT

Transverse reinforcement in drilled shafts shall meet all of the following (minimum) requirements:

- Shear design requirements. See Section 16.7.2 of this manual (below) and AASHTO Article 5.8.
- Minimum requirements for transverse reinforcement determined in accordance with AASHTO Article 5.7.4.6 (see Equation 16-4, below), Note that this requirement applies to all Seismic Zones

- Minimum confinement requirements for seismic design, determined in accordance with AASHTO Articles 5.10.11.4.1d, 5.10.11.4.1e and 5.13.4.6. Note that the transverse reinforcement requirements specified for Seismic Zones 3 and 4 under Sections 5.10.11.4.1d and 5.10.11.4.1e also apply to Seismic Zone 2, per AASHTO Article 5.10.11.3.

For all seismic zones, from the top of the drilled shaft to a depth of at least 3.0 diameters below the calculated depth of moment fixity, the minimum transverse reinforcement can be determined using Equation 16-4:

$$\rho_s \geq 0.45 \left( \frac{A_g}{A_c} - 1 \right) \frac{f_c'}{f_{yh}} \quad (\text{AASHTO 5.7.4.6-1}) \quad 16-4$$

Where:  $\rho_s$  = Ratio of spiral or seismic hoop reinforcement to total volume of concrete core  
 $A_g$  = Gross area of column section (in<sup>2</sup>)  
 $A_c$  = Area of the concrete core measured to the outside diameter of the spiral (in.)  
 $f_c'$  = Specified strength of concrete at 28 days (ksi)  
 $f_{yh}$  = Specified yield strength of spiral or hoop reinforcement (ksi)

In addition, for Seismic Zones 2, 3, and 4, from the top of the drilled shaft to a depth of at least 3.0 diameters below the calculated depth of moment fixity, the minimum transverse reinforcement can be determined using Equation 16-5:

$$\rho_s \geq 0.12 \frac{f_c'}{f_y} \quad (\text{AASHTO 5.10.11.4.1d-1}) \quad 16-5$$

where:  $\rho_s$  = Ratio of spiral or seismic hoop reinforcement to total volume of concrete core  
 $f_c'$  = Specified strength of concrete at 28 days (ksi)  
 $f_y$  = Specified yield strength of spiral or hoop reinforcement (ksi)

For Seismic Zones 2, 3 and 4, the maximum pitch of spiral reinforcement or spacing of seismic hoops shall be 4.0 inches down to a depth of at least 3.0 diameters below the depth of moment fixity and 9.0 inches below that depth (AASHTO Article 5.13.4.6.2b). For Seismic Zone 1, the maximum pitch of spiral reinforcement or spacing of seismic hoops shall be 6.0 inches down to a depth of at least 3.0 diameters below the depth of moment fixity and 12.0 inches below that depth (AASHTO Article 5.13.4.5.2). In all cases, spirals or seismic hoops shall not be smaller than #3 bars.

The clear distance between parallel transverse reinforcing bars should not be less than five times the maximum aggregate size or 5.0 inches, whichever is greater (AASHTO 5.13.4.5.2). In seismic zones this can be a challenge because high steel ratios are often dictated by the earthquake force effects. An effort should be made to meet the minimum 5-inch spacing requirement by bundling the longitudinal bars, as necessary.

A typical layout for longitudinal and transverse reinforcement in a drilled shaft is shown in Figure 16-2.



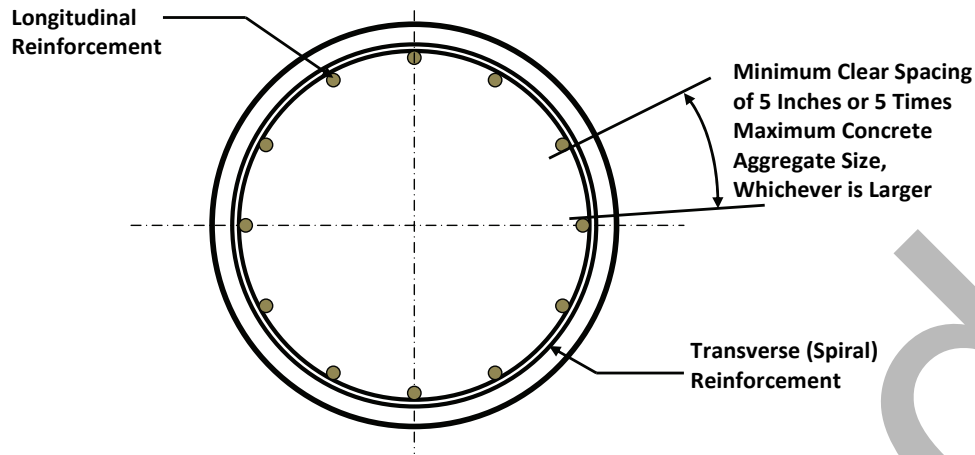


Figure 16-2 Transverse (Confinement) Reinforcement Details (AASHTO Figure C5.10.11.4.1d-1)

## 16.5 CONCRETE COVER AND CAGE CENTERING DEVICES

Recommended minimum concrete covers to the primary (longitudinal) reinforcing steel (including rebars protected by epoxy coating) for drilled shafts are as follows:

- 3.0 inches for shafts  $\leq 3'-0"$  diameter
- 4.0 inches for  $> 3'-0"$  but  $< 5'-0"$  diameter
- 6.0 inches for shafts  $\geq 5'-0"$  diameter

The cover required for transverse reinforcement may be less than required for longitudinal bars by no more than 0.5 inch. Transverse reinforcement larger than 0.5 inch diameter would thus necessitate greater cover than specified above for longitudinal bars.

The above minimum concrete covers are for concrete with water-to-cementitious material ratios (W/CM) between 0.40 and 0.50. For W/CM ratios equal to or greater than 0.50, the cover requirements must be increased by a factor of 1.2. For W/CM ratios less than or equal to 0.40, the cover requirements may be decreased by a factor of 0.8. The modification factors of 1.2 and 0.8 are in recognition of the changes in concrete permeability resulting from higher and lower values of W/CM ratio. However, low W/CM ratios can lead to constructability problems because the flow characteristics and ability of concrete to pass through the rebar cage generally decrease at low W/CM ratios.

Centering devices must be used with drilled shaft construction to maintain alignment of the steel reinforcing cages and maintain the required minimum concrete cover. The centering devices are often plastic “wheels” installed around the transverse reinforcement. The wheels must be oriented such that they roll along the borehole wall without scraping into the soil.

## 16.6 CASES WITH AXIAL LOAD ONLY

### 16.6.1 Axial Compression

For some applications, the force effects transmitted to drilled shafts are predominately axial compression with zero to small moment and shear. Structurally, this can be designed for axial compression only.

Examples of this case include the lower portion of a drilled shaft deeper than 3.0 diameters below the equivalent depth of fixity. Any eccentricity of the axial load is ignored explicitly (although included implicitly) in this computation.

Equation 16-6 can be utilized in LRFD for calculating the factored nominal structural resistance of a short, reinforced concrete column subjected only to compressive axial load.

$$P_r = \phi P_n = \phi \beta [0.85 f'_c (A_g - A_s) + A_s f_y] \quad (\text{AASHTO 5.7.4.4}) \quad 16-6$$

Where:  $P_r$  = Factored axial resistance of an axially loaded short column (drilled shaft)  
 $P_n$  = Nominal axial resistance  
 $\phi$  = Resistance factor (see below)  
 $\beta$  = Reduction factor, 0.85 for spiral reinforcement, and 0.80 for tie reinforcement.  
 $f'_c$  = Specified minimum compressive strength of concrete,  
 $A_g$  = Gross area of section  
 $A_s$  = Total area of longitudinal reinforcement  
 $f_y$  = Specified yield strength of reinforcement

The resistance factor,  $\phi$ , is equal to 0.75 for compression-controlled sections with either spiral or ties used for transverse reinforcement. An exception is for the case of extreme event seismic loading in Seismic Zones 2, 3 and 4, where  $\phi$  is taken as 0.90 for sections with either spiral or ties as transverse reinforcement (reference AASHTO 5.5.4.2, 5.10.11.3 and 5.10.11.4.1b).

In executing a preliminary design to obtain the approximate cross-sectional area and longitudinal steel schedule, a reasonable percentage of steel of from 1 to 4 percent (preferably not more than 2% to 2.5%) of the gross column section area,  $A_g$ , can be assumed. If the drilled shaft is subjected to an axial load having an eccentricity larger than is permitted in the construction specifications for horizontal position of the drilled shaft, or if force effects include shear or moment, a lateral load analysis should be carried out. Note that an eccentric axial load will generate bending and therefore the shaft must be designed as a beam-column. Depending on the level of load eccentricity and the magnitudes of the lateral loads, the structural resistance for axial loading (alone) should be well in excess of the factored axial load so that the section will also be found to be safe under moment.

### 16.6.2 Tension Members

Drilled shafts subjected to uplift force effects, either from load combinations applied to the bridge or from expansive soils, can be regarded as tension members and the axial forces are assumed to be resisted by the steel elements only. The LRFD equation for structural strength in tension is:

$$P_r = \phi P_n = \phi (f_y A_{st}) \quad (\text{AASHTO 5.7.6.1-1 and 5.6.3.4.1-1}) \quad 16-7$$

Where:  $P_r$  = Factored axial resistance in tension  
 $P_n$  = Nominal axial resistance in tension  
 $\phi$  = Resistance factor = 0.90  
 $f_y$  = Specified yield strength of steel reinforcement  
 $A_{st}$  = Total area of longitudinal steel reinforcement

## 16.7 CASES WITH AXIAL LOAD AND BENDING MOMENT

### 16.7.1 General Concepts

When a cross-section of an axially loaded drilled shaft is subjected to a bending moment from any source, there is a corresponding decrease in its axial structural resistance. The decrease can be explained by referring to Figure 16-3. The curve in Figure 16-3a shows the combinations of maximum axial load and maximum bending moment that the cross section of the drilled shaft can carry at the structural limit state. Points inside the curve, called an "interaction diagram", give combinations of axial load and moment that can be sustained; points on the curve, or outside of it, define a structural limit state. Interaction diagrams for a given cross section can be generated using several commercially available computer programs, for example LPILE (Ensoft, Inc., 2004), spColumn (formerly PCAColumn; Structure Point Software, 2010), and others.

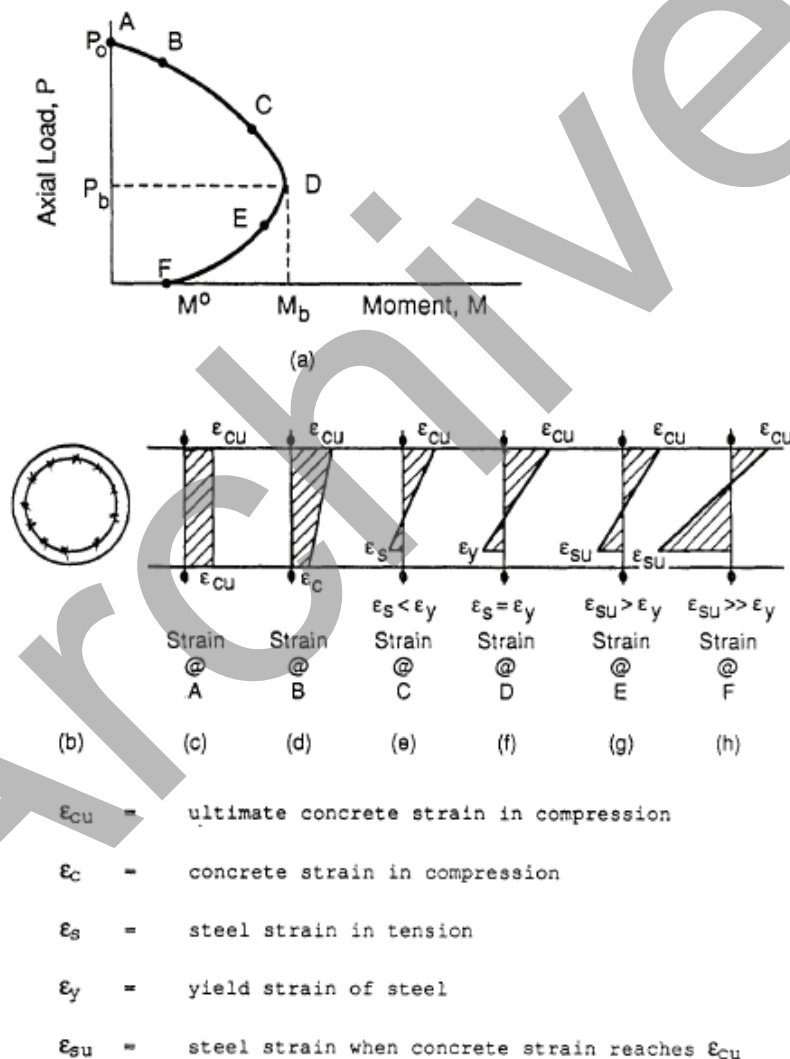


Figure 16-3 Interaction Diagram for a Reinforced Concrete Column

Although Figure 16-3 treats the case of combined axial compression and bending, the concepts presented in this section are equally valid and applicable to a reinforced concrete beam-column (drilled shaft) subjected to combined axial tension and bending.

Figure 16-3b shows a schematic of a drilled shaft cross section that is being analyzed to obtain the interaction diagram. The diagrams in parts (c) through (h) of Figure 16-3 illustrate the assumed distribution of strain in the cross section when it is subjected to different combinations of axial compressive load and bending moment, represented by the points on the interaction curve A, B, C, D, E and F, respectively. When failure occurs due to axial load only ( $P_o$  as at point A in Figure 16-3a), a uniform compressive strain  $\epsilon_{cu}$  exists across the entire cross section (Figure 16-3c), where  $\epsilon_{cu}$  is the compressive strain that causes crushing in the concrete (0.003). When failure occurs with a lesser axial load combined with a small amount of bending moment, as at point B, the strain distribution on the cross section is no longer uniform. The top-fiber strain reaches the value of  $\epsilon_{cu}$  whereas the bottom-fiber strain is reduced, but may still be compressive as in Figure 16-3d, if the moment is not large.

For a condition where bending moment is increased further and axial load decreased further, as represented by point C, part of the cross section is subjected to tension, which is taken by steel reinforcement if, for simplicity, it is assumed that the concrete is a material that cannot resist tension. This is a stage when sufficient tension is not developed to cause yielding of the steel, and the failure is still by crushing in the concrete. Proceeding to the state represented by point D, the failure combination of axial load and bending moment is such that the ultimate strain  $\epsilon_{cu}$  in the concrete and tensile yield strain  $\epsilon_y$ , in the steel are simultaneously reached. This stage is known as the balanced condition, and  $M_b$  and  $P_b$  are the moment and axial load resistances of the section at the balanced condition. At any failure combination between points A and D on the curve, failure is caused by crushing in the concrete before the steel yields.

Tensile yielding in the steel can occur with a lesser bending moment than that at the balanced condition if the compression is removed by decreasing the axial load. This stage is represented by the lower portion, DF, of the curve. Since the axial load is less, the steel yields before the ultimate concrete strain,  $\epsilon_{cu}$  is reached. With further bending, the concrete compressive strain reaches  $\epsilon_{cu}$  and failure occurs. At point F the section is subjected to bending moment only ( $M_o$ ), and failure occurs well after the steel yields.

Because the resistance of a cross section with given properties of steel and concrete depends upon the percentage of reinforcement and the position of the steel with respect to the centroidal axis, a set of interaction diagrams needs to be drawn for each drilled shaft cross section that is analyzed.

The nominal resistance interaction diagram, shown as the solid line in Figure 16-3 and Figure 16-4, should be obtained for all critical sections of the drilled shaft. Computer programs for lateral analyses typically include options for generating this interaction diagram for specified cross-sections. The factored resistance interaction diagram, illustrated as a dashed line in Figure 16-4, identifies the boundary in which factored force effects should reside. The method to determine the boundary is described herein.

The factored resistance interaction diagram (shown as the dashed line in Figure 16-4) is determined by multiplying the nominal moment and nominal axial resistances by the resistance factor  $\phi$ .

$$P_r = \phi P_n \quad (\text{AASHTO 5.7.4.4-1}) \quad 16-8$$

$$M_r = \phi M_n \quad (\text{AASHTO 5.7.3.2.1-1}) \quad 16-9$$

Where:

$P_r$	=	Factored axial resistance
$P_n$	=	Nominal axial resistance
$M_r$	=	Factored moment resistance
$M_n$	=	Nominal moment resistance
$\phi$	=	Resistance factor (see below)

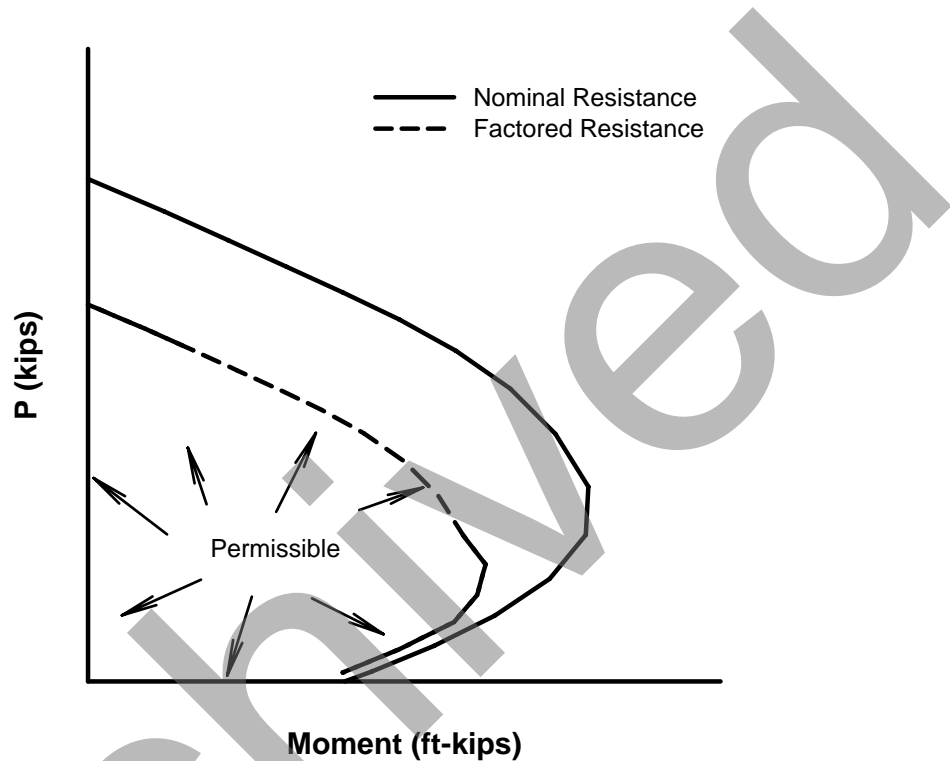


Figure 16-4 Nominal and Factored Interaction Diagrams

The interaction diagram uses a resistance factor ( $\phi$ ) that is variable and is determined by the strain conditions in the structural cross-section, at nominal strength. Therefore, resistance factors are different for compression-controlled and tension-controlled sections. Sections are considered “tension controlled” if the tensile strain (in the extreme tensile steel) at nominal strength is greater than 0.005. A value of 0.9 is used as  $\phi$  for a tension-controlled section. A “compression-controlled” section uses a  $\phi$  of 0.75 and is defined as a cross-section for which the net tensile strain ( $\epsilon_t$ ) in the extreme tensile steel at nominal strength is less than or equal to the compression controlled strain limit of 0.003 (refer to AASHTO Articles 5.7.2.1 and C5.7.2.1).

Linear interpolation is used to determine  $\phi$  for sections that transition between tension-controlled and compression-controlled (see plot in Figure 16-5). The transition formula for  $\phi$  can also be given by Equation 16-10:

$$0.75 \leq \phi = 0.65 + 0.15 \left( \frac{d_t}{c} - 1 \right) \leq 0.9 \quad (\text{AASHTO 5.5.4.2.1-2}) \quad 16-10$$

Where:  $c$  = Distance from the extreme compression fiber to the neutral axis (inches)  
 $d_t$  = Distance from the extreme compression fiber to the centroid of the extreme tensile element (inches)

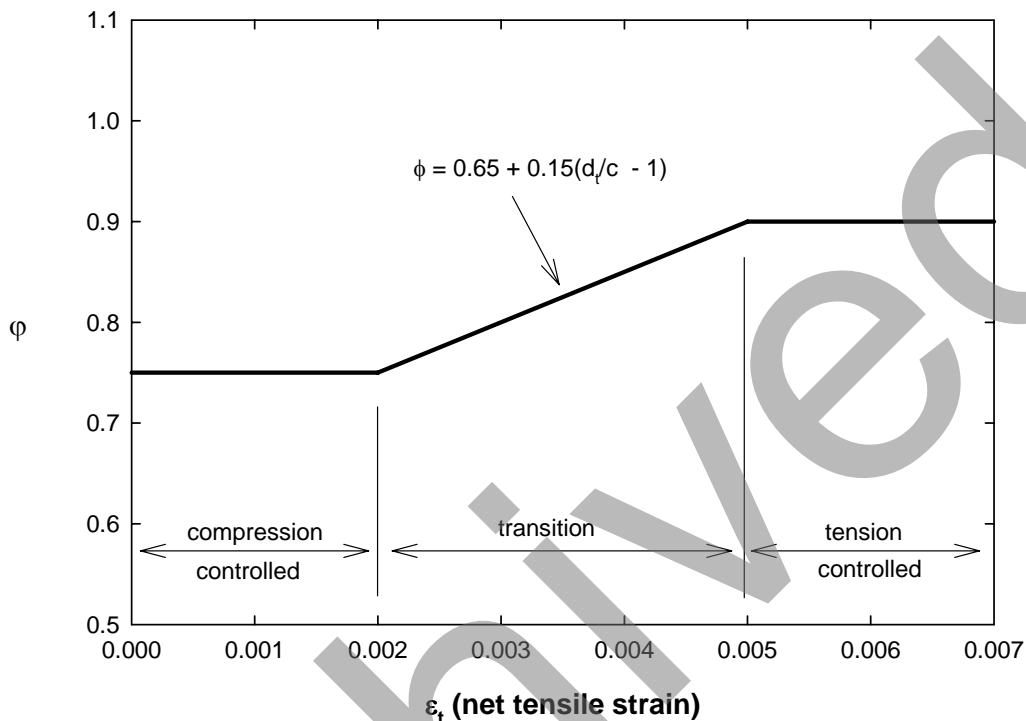


Figure 16-5 Variation of  $\phi$  with Net Tensile Strain,  $\epsilon_t$  and  $d_t/c$  for Grade 60 Reinforcement

In addition to the P-M interaction diagram, the factored axial resistance (Equation 16-6 or Equation 16-7 above) should also be considered and may control for cases in which axial loads dominate.

Cases involving combined axial tension and bending are analyzed by applying the same concepts described above for combined axial compression and bending. A notable difference would be that the strength limit state is always tension-controlled; therefore the resistance factor is  $\phi = 0.90$ .

### 16.7.2 Structural Design Procedure: Longitudinal and Transverse Reinforcement

The procedures described in this section are applicable to the design of drilled shafts without permanent casing. Some of the procedures described in this section are also applicable to drilled shafts with permanent casing, which is addressed further in Section 16.8.2.

Structural design of a drilled shaft is executed following the step-by-step procedure outlined below, which deals only with compressive axial loading and seismic conditions.

1. Determine the factored axial, moment, and shear force effects that are transmitted to critical sections of the drilled shaft. In some cases the critical section will be at the head of the drilled

shaft (for example, for the case where multiple drilled shafts support a common pile cap and the cap is rigid enough that the shafts approximate a “fixed head” condition). For cases where the shaft behavior approximates a “fixed head” condition, the designer may choose to size the section based on these loads and to verify the appropriateness of the section properties later using a comprehensive p-y analysis. Otherwise, a preliminary analysis of the drilled shaft can be conducted using one of the lateral load analysis procedures described in Chapter 12 of this manual.

Factored force effects, applied to the head of the shaft, are used to obtain moment and shear diagrams along the shaft as a function of depth in order to estimate the highest values of shear and moment that occur along the shaft. It is customary to assume that the axial load  $P_x$  acting on any such section is equal to the axial force transmitted to the head. The results of the preliminary lateral drilled shaft analysis using factored force effects can be considered to be the factored forces (shear, moment and axial thrust) that act on the section under consideration.

2. Check whether the factored axial force is well within the factored nominal axial structural resistance  $\phi(P_n)$  of the shaft using Equation 16-6 (compression) or Equation 16-7 (tension). If not, increase the section appropriately.

Judgment is involved in determining how safe the design needs to be against axial load alone. If the estimate at this point is unsafe or overly conservative, it will be shown to be so later, and the designer will need to return to this step.

3. Check to see whether the concrete section has adequate shear resistance with the minimum transverse reinforcement ratio as specified in Section 16.3. The factored shear resistance of a section with the minimum shear reinforcement is calculated as:

$$V_r = \phi V_n \quad (\text{AASHTO 5.8.2.1-2}) \quad 16-11$$

Where:

$\phi$  = Capacity reduction (resistance) factor for shear (AASHTO 5.5.4.2)

= 0.90 for normal weight concrete

= 0.70 for lightweight concrete

$V_n$  = Nominal (computed, unfactored) shear resistance of the section,

The nominal shear resistance  $V_n$  is determined as the lesser of:

$$V_n = V_c + V_s \quad (\text{AASHTO 5.8.3.3-1}) \quad 16-12a$$

and

$$V_n = 0.25 f'_c b_v d_v \quad (\text{AASHTO 5.8.3.3-2}) \quad 16-12b$$

where:  $V_c$  = the limiting concrete shear stress, defined as:

$$V_c = 0.0136 \beta \sqrt{f'_c} A_v \quad (\text{AASHTO 5.8.3.3-3}) \quad 16-13$$

where:  $A_v$  = area of the column cross section that is effective in resisting shear, which can be taken as the equivalent of  $b_v \cdot d_v$  for a circular drilled shaft, where:

$$b_v = D$$

$$d_v = 0.9 \left( \frac{D}{2} + \frac{D_r}{\pi} \right) \quad (\text{see Figure 16-6})$$

$D$  = external diameter of the drilled shaft, and

$D_r$  = diameter of the circle passing through the centers of the longitudinal rebars.

Figure 16-6 shows a cross section of a circular reinforced concrete column (or drilled shaft) and defines the terms used above to describe its geometry.

Alternatively,  $A_v$  may be taken as  $0.80 \times A_{\text{gross}}$  (reference: ATC 32-1 Section 7.3.4)

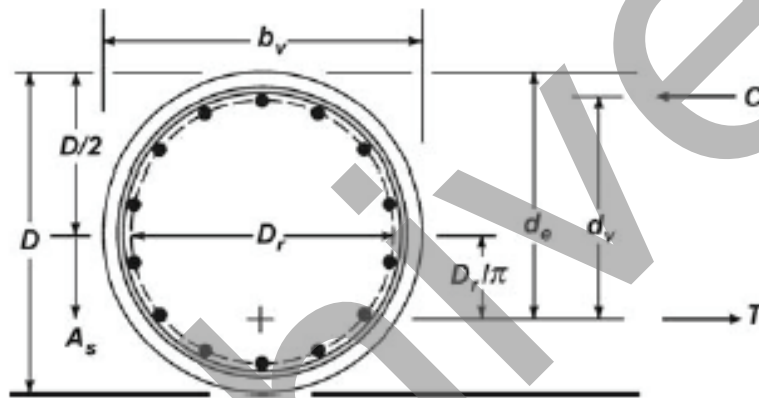


Figure 16-6 Illustration of Terms  $b_v$ ,  $d_v$  and  $d_c$  for Circular Sections (reference AASHTO C5.8.2.9)

If the factored shear force acting on the section is greater than the factored resistance, determined above, several options are available. The first and simplest solution is to increase the column size (diameter of the drilled shaft) to increase  $A_v$  and thus increase the shear resistance. A second alternative is to use a higher concrete compressive strength. The third (and recommended) alternative is to include a specific contribution for the amount of shear reinforcement. Including the shear resistance contribution from the transverse reinforcement is the recommended alternative as this will result in a more economical design.

The shear resistance from the transverse reinforcement can be computed per AASHTO Equation 5.8.3.3-4, as follows:

$$V_s = \frac{A_v f_y d_v (\cot \theta + \cot \alpha) \sin \alpha}{s} \quad (\text{AASHTO 5.8.3.3-4}) \quad 16-14$$

Where:

$A_v$  = Area of shear reinforcement within a distance  $s$

$s$  = Spacing of the ties along the axis of the member (spiral pitch)



- $V_s$  = Nominal shear resistance of transverse steel
- $f_y$  = Yield strength of transverse steel
- $d_y$  = Effective shear depth (see above)
- $\theta$  = Angle of inclination of diagonal compressive stresses, taken as  $45^\circ$
- $\alpha$  = Angle of inclination of transverse reinforcement to longitudinal axis

Alternatively, the shear resistance from the transverse reinforcement can be computed following the recommendations in ATC 32-1:

$$V_s = \frac{\pi A_h f_{yh} D'}{2s} \cot \theta \quad (\text{ATC 32-1 Equation 7-20}) \quad 16-15$$

Where:

- $A_h$  = Area of a single hoop
- $s$  = Spacing of the ties along the axis of the member (spiral pitch)
- $V_s$  = Nominal shear resistance of transverse steel
- $f_{yh}$  = Yield strength of transverse steel
- $D'$  = Diameter of circular hoop (spiral)
- $\theta$  = Angle of inclination of diagonal compressive stresses, taken as  $45^\circ$

4. Determine an amount and distribution of longitudinal steel required for the section to resist axial load and moment.
  - a) Assume a reasonable percentage of longitudinal reinforcement (1 percent) and generate the interaction (P-M) diagram.
  - b) Check if the factored axial and moment force effects fall within the acceptable zone on the interaction curve. If not, increase amount and distribution of longitudinal reinforcement steel. AASHTO limits the reinforcement ratio,  $\rho_s$ , to a minimum of 1 percent and maximum of 8 percent in the portions of the shaft that behave as a column. Columns with high reinforcement ratios (more than 4 percent reinforcement) generally result in crowding of steel with little possibility of splicing (dowels for example). Better practice is to limit the maximum reinforcement to less than 4 percent (less than 2 percent is more desirable) depending on the requirement for continuity with the supported structure. In some cases, *i.e.* three diameters below moment fixity, the percentage of longitudinal reinforcement can be as small as 0.5 percent.
  - c) Select the actual steel reinforcement, *i.e.*, size and number of bars, and bar spacing. Keep in mind the requirement for designing for constructability (*e.g.*, maintain adequate bar spacing by bundling bars if necessary).
  - d) Continue to iterate until the design satisfies LRFD structural limit state criteria and construction requirements with an efficient cross-section.
5. Select appropriate ties or spirals according to AASHTO, and ensure that the spacing between reinforcement satisfies requirements for constructability.

Appendix A presents a comprehensive design example which illustrates this procedure, and typical design details for drilled shafts without casing are shown in Figure 16-7 and Figure 16-8.

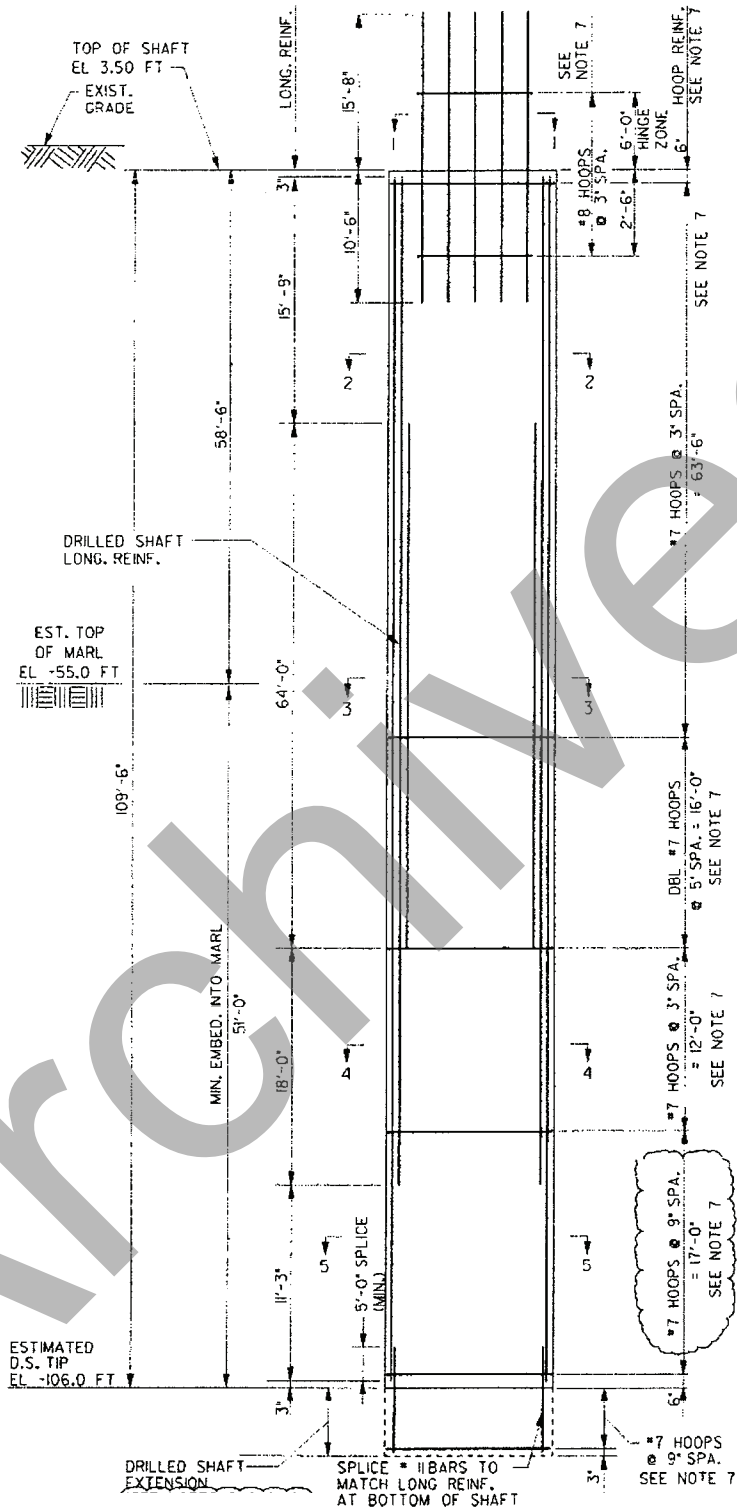


Figure 16-7 Sample Elevation of Drilled Shaft without Casing

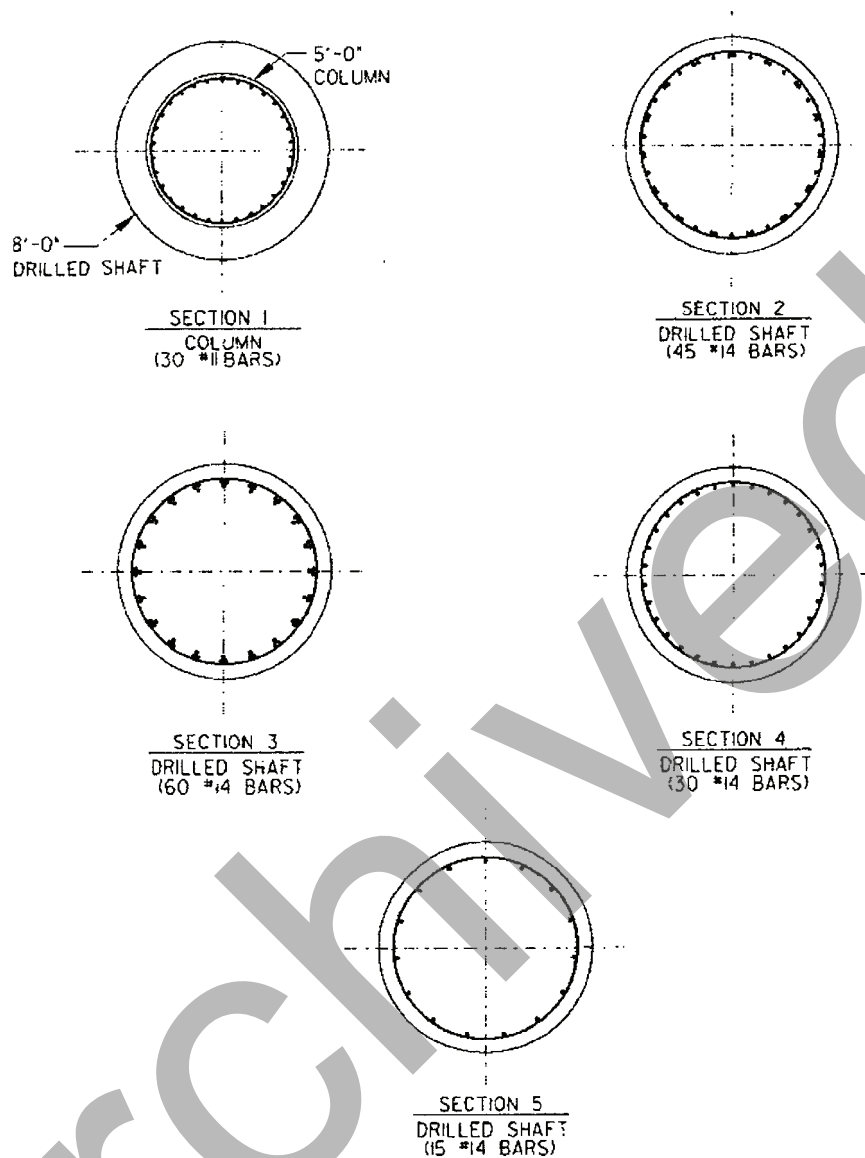


Figure 16-8 Typical Sections without Casing

### 16.7.3 Depth of Transverse Reinforcement

One issue in the structural design of axially loaded drilled shafts that has not been completely resolved with solid research is the depth below the ground surface to which the spirals or ties need to continue as if the drilled shaft were a structural column. Historically, many agencies have required spirals or ties, as determined from code requirements, down to a depth of 10 to 12 shaft diameters below the ground surface when the soil is stiff or dense, or down to the top of a solid rock socket, whichever is less. While it may seem conservative, from a structural viewpoint, to extend closely spaced transverse reinforcement to the full length of a drilled shaft, eliminating steel reinforcement that is not necessary decreases the potential risk of defects by providing more space for concrete to flow through the reinforcing cage. For deep drilled shafts, extending transverse reinforcement can add costs which are not necessary. However, some

transverse reinforcement is required even in the lower portions of the shaft to maintain stability of the rebar cage during transportation and placement.

Current recommendations regarding the spacing and limits of transverse reinforcement are given in Section 16.4, above. These recommendations differ depending on the Seismic Zone; more transverse reinforcement (and at closer spacing) is required for Seismic Zones 2, 3, and 4 than for Seismic Zone 1. For all seismic zones, a closer spacing of transverse reinforcement is required in the portion of the shaft where it behaves as a beam-column, which is assumed to be at a depth of at least 3.0 diameters below the computed depth of moment fixity. Below this point, the spacing of transverse reinforcement can be increased to a maximum of 9.0 inches for Seismic Zones 2, 3 and 4, and 12.0 inches for Seismic Zone 1.

#### 16.7.4 Splices, Connections, and Cutoffs

For constructability reasons, it is usually desirable to provide a construction joint at the head of a drilled shaft, approximately at the ground surface. The drilled shaft may be of the same diameter as the column (*i.e.* Caltrans Type I shaft) or may be of a larger diameter than the column (*i.e.* Caltrans Type II shaft). In either case, if a joint is provided at the head of the drilled shaft, the required transverse reinforcement should extend one-half of the column or drilled shaft diameter, whichever is larger, into the column, or 15 inches minimum, in accordance with AASHTO 5.10.11.4.3. This requirement for extending the transverse reinforcement applies to all Seismic Zones.

For lap joints at the interface with the column or cap, or for lap joints within the drilled shaft, the longitudinal shaft rebars should lap the longitudinal bars from the column or cap, or the bars in the adjoining section of cage, by the length required to develop the full yield strength of the reinforcement,  $l_d$ , as specified in Section 5.11 of AASHTO. The same is true for the development of longitudinal drilled shaft reinforcement into a footing or pile cap. For Seismic Zones 2, 3 and 4, the lap length is increased by a factor of 1.25 to develop the over strength resistance of the reinforcement, per AASHTO 5.10.11.4.3.

The length required to develop the full yield strength of the reinforcement,  $l_d$ , in inches, for bars in tension is taken as the product of the basic development length,  $l_{db}$ , and the applicable modification factors listed under AASHTO 5.11.2.1.2 (modification factors that increase  $l_d$ ), and AASHTO 5.11.2.1.3 (modification factors that increase  $l_d$ ). In no case should the development length  $l_{db}$  be less than 12.0 inches for bars in tension.

The basic development length for tension bars,  $l_{db}$ , in inches, is taken as follows:

For No. 11 bars and smaller:

$$l_{db} = \frac{1.25A_y f_y}{\sqrt{f_c'}} \text{ but not less than } 0.4d_b f_y \quad (\text{AASHTO 5.11.2.1.1}) \quad 16-16$$

For No. 14 bars:

$$l_{db} = \frac{2.70 f_y}{\sqrt{f_c'}} \quad (\text{AASHTO 5.11.2.1.1}) \quad 16-17$$

For No. 18 bars:

$$l_{db} = \frac{3.5f_y}{\sqrt{f_c'}} \quad (\text{AASHTO 5.11.2.1.1}) \quad 16-18$$

The length required to develop the full yield strength of the reinforcement,  $l_d$ , in inches, for bars in compression is taken as the product of the basic development length,  $l_{ab}$ , and the applicable modification factors listed under AASHTO 5.11.2.2.2. In no case should the development length  $l_{ab}$  be less than 8.0 inches for bars in compression.

The basic development length for compression bars,  $l_{ab}$ , in inches, is taken as the greater of the following:

$$l_{db} \geq \frac{0.63d_b f_y}{\sqrt{f_c'}} \quad (\text{AASHTO 5.11.2.2.1-1}) \quad 16-19$$

and

$$l_{db} \geq 0.3d_b f_y \quad (\text{AASHTO 5.11.2.2.1-2}) \quad 16-20$$

In the above equations,  $f_c'$  is the cylinder strength of the concrete at 28 days in ksi,  $f_y$  is the nominal yield strength of the steel in ksi,  $d_b$  is the diameter of the bar in inches, and  $A_{bs}$  is the cross-sectional area of the bar in  $\text{in}^2$ .

It should be noted that, even though the drilled shaft as a whole may be in net compression for all loading cases, the longitudinal steel may still be in tension under some loading conditions due to bending effects. Generally, the development lengths for tension reinforcement should be used.

Similar rules apply to rebar cutoffs and to lapping of transverse steel.

For drilled shafts under axial tension only, as may occur under uplift loading, AASHTO Article 5.11.5.4 states that reinforcement splices shall be made only with full-welded splices or full-mechanical splices.

## 16.8 OTHER CONSIDERATIONS

### 16.8.1 Drilled Shafts with Rock Sockets

It may be necessary for drilled shafts to extend into rock to resist the effect of lateral load. Non-linear p-y analyses can be used to estimate the shear and moment along the length of the shaft. This type of load and soil profile often results in the magnitude of maximum shear occurring in the rock significantly greater than applied shear load. Additional considerations are needed to assess the limitations of current analysis methods.

A simple example of the moment and shear distribution for a rock-socketed shaft is given in Figure 16-9. The example is for a 4-ft diameter drilled shaft docketed into rock. The analysis predicts the shear to be a constant 20 kips along the cantilevered portion of the shaft (top 15 ft) and then upon embedment into the

rock, the shear changes sign and reaches a maximum value of -76 kips. The moment increases linearly and reaches a maximum of 300 k-ft at the rock surface, and then decreases with embedment. For comparison, shear and moment diagrams are also given for a cantilevered column fixed at the ground surface. One would expect the behavior of a cantilevered column to be similar to the behavior of a drilled shaft docketed into very strong rock (stronger and stiffer than the concrete of the drilled shaft). The shear and moment diagrams for the cantilevered portion of the drilled shaft and column agree exactly. However, the drilled shaft and the column differ considerably for the estimate of maximum shear. The maximum shear in the cantilevered column is 20 kips, while the maximum shear in the drilled shaft is predicted to be 76 kips. If the analysis for the drilled shaft is repeated with a stronger rock, the maximum shear becomes even greater.

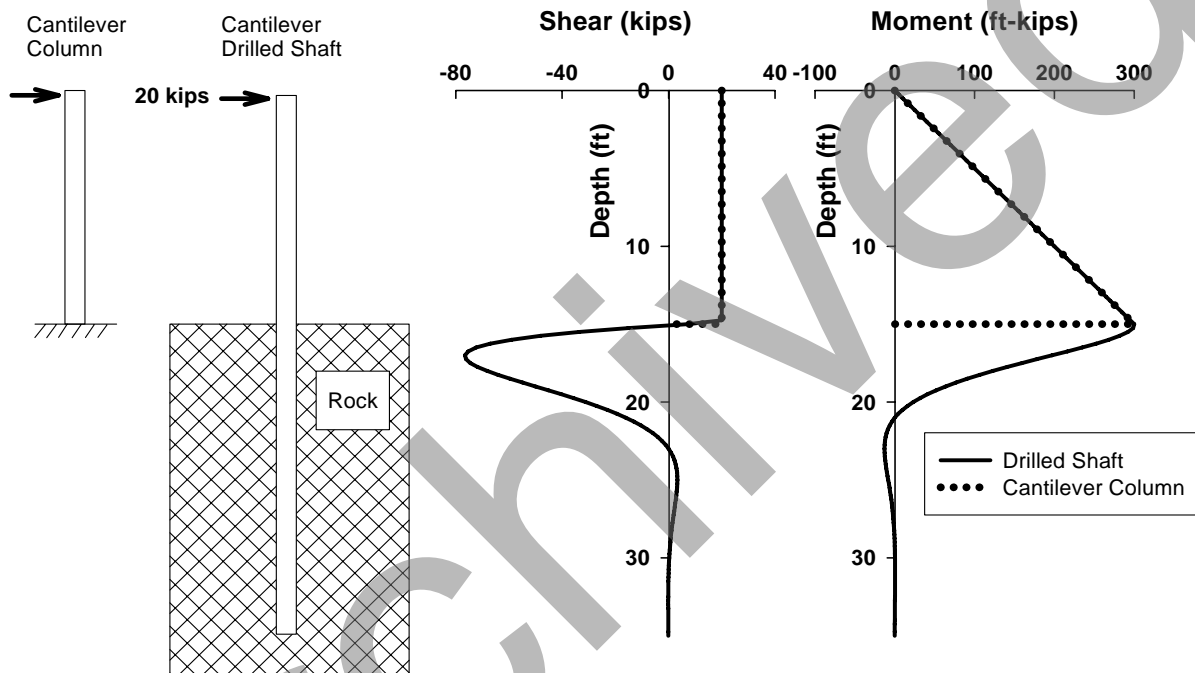


Figure 16-9 Comparison of Moment and Shear for a Cantilevered Column and a Docketed Drilled Shaft

This behavior may be due to the limitations of the analysis method currently employed in lateral load analyses. The limitations are based on how the soil resistance and the drilled shaft are modeled. The soil is modeled as a series of non-linear springs that resist horizontal loads. However, as the drilled shaft rotates, the face of the shaft moves vertically (downward on the front face and upward on the back face). The downward movement develops resistance in the rock which provides an additional component of rotational resistance to the drilled shaft. The drilled shaft is modeled as a beam that acts in bending only and ignores the shear stiffness of the drilled shaft. Including these two components will assist in providing a more accurate estimate for shear and moment versus depth for drilled shafts embedded in rock sockets.

The distribution of shear in Figure 16-9 illustrates that the maximum shear occurs along a short portion of the shaft. Until these issues are resolved, it is recommended to use the average shear along a length equivalent to 1 shaft diameter for design purposes.

## 16.8.2 Drilled Shafts with Permanent Casing

As discussed in detail in Chapter 6 “Casing and Liners”, the steel casing occasionally remains in-place and becomes a permanent part of the drilled shaft foundation. This is always the case for drilled shafts in water and is sometimes the case for drilled shafts on land, depending on the site conditions. The structural design for the drilled shaft may, or may not include the effect of the permanent casing. This section discusses the effect of the casing on the structural behavior and structural design of the drilled shaft. Figures 16-10 and 16-11 show typical details for drilled shafts constructed with permanent casings.

Per AASHTO 5.13.4.5.2, a permanent steel casing may be considered as structurally effective in resisting axial loads and bending moments (*i.e.* may be considered as part of the longitudinal reinforcement) if the casing thickness is greater than 1/8-inch. However, the use of permanent casing to increase the structural properties for the shaft should consider the effects of corrosion by using a thickness expected at the end of its design life. In corrosive environments, a reduction in the casing thickness should be considered for design purposes to allow for corrosion losses over time. The minimum reduction (per AASHTO) is 1/16-inch, but consideration should be given to increasing this reduction for casings that are directly exposed to salt water, especially in splash zones. Section 6.2.3 of this manual provides additional discussion on corrosion losses for steel casings.

Permanent casings may also be considered effective in resisting shear forces and providing confinement, subject to the limitations described above.

There are several advantages associated with the use of permanent casing for a drilled shaft. The casing provides longitudinal reinforcement on the outside perimeter of the foundation, which is the most efficient location for increasing flexural stiffness and resistance. The casing provides continuous lateral confinement to the concrete which improves the strength and ductility of the concrete. The casing prevents the concrete from spalling. The casing provides a barrier between the concrete and soil.

The behavior of concrete-filled steel tubes (CFT) provides the majority of the theoretical and experimental research relevant to structural behavior of drilled shafts with permanent casing. Elremaily and Azizinamini (2002) reviewed several experimental studies conducted on concrete filled tubes. While most of the CFT's reviewed had diameters less than 6 inches, a few had diameters greater than 8 inches, and they conducted several tests with a diameter equal to 12.75 inches.

They compared experimental results with predicted resistance for CFT's subjected to different combinations of axial load and moment. They found excellent agreement for analyses when using a moment-curvature approach (see Section 16.7.1) combined with a concrete model proposed by Mander et al. (1988) that included the effect of lateral confinement on the stress-strain and strength of the concrete. Lateral confinement was determined as the twice the hoop stress in the steel multiplied by the wall thickness and divided by the tube diameter. Elremaily and Azizinamini recommend using a hoop stress equal to one-tenth of the yield strength of the steel.

The steel for a concrete filled tube is different than for a conventional concrete column subjected to axial load and bending. A conventional concrete column employs longitudinal steel to resist both axial loads and transverse steel to provide lateral confinement. But the steel in the casing is simultaneously subjected to hoop stress (from lateral confinement) and axial stress. Accordingly, the tensile stress available for resisting axial stress is reduced to  $0.95f_y$ , while the compressive stress available is increased to  $1.05f_y$ .

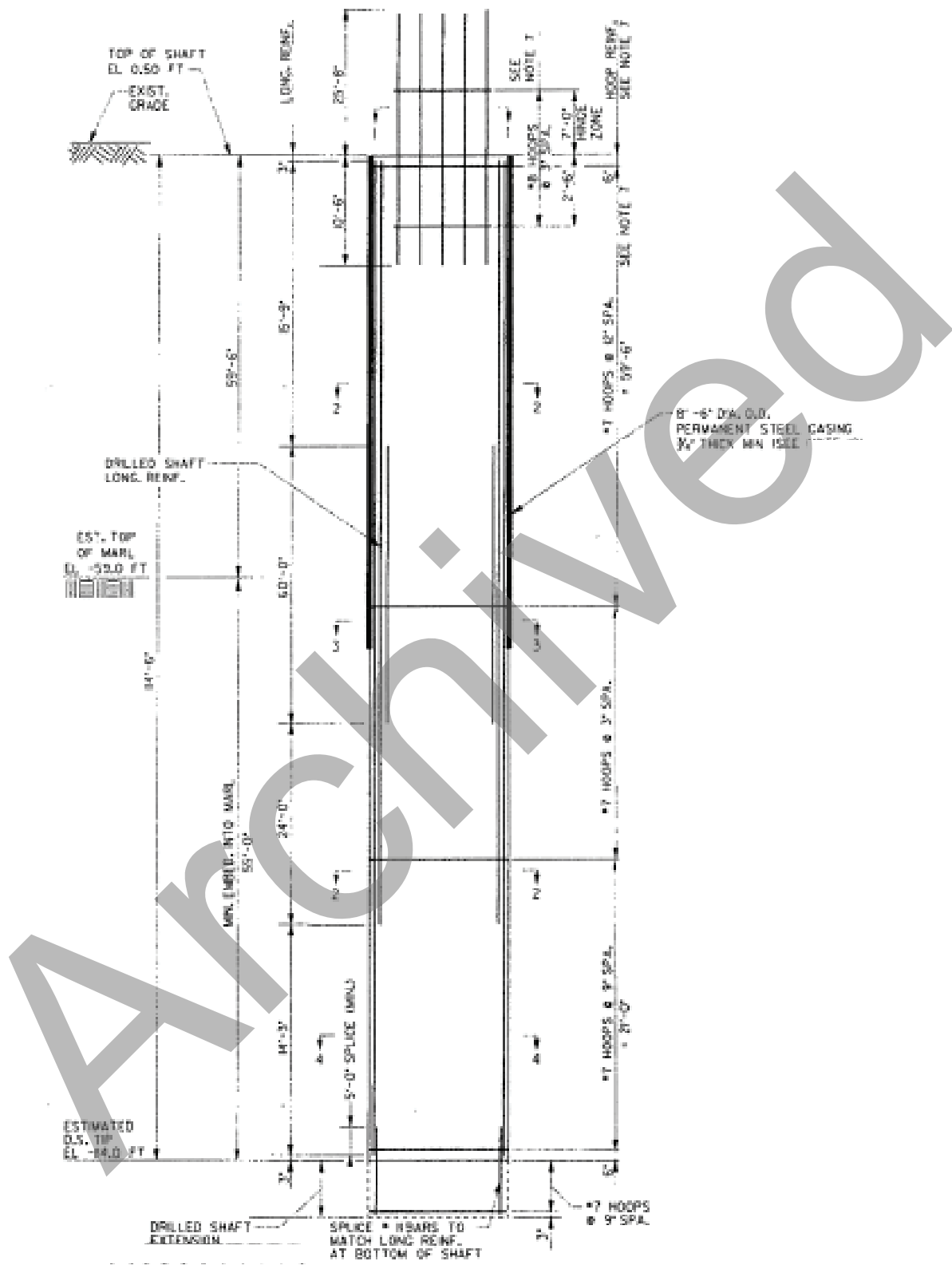


Figure 16-10 Sample Elevation with Casing



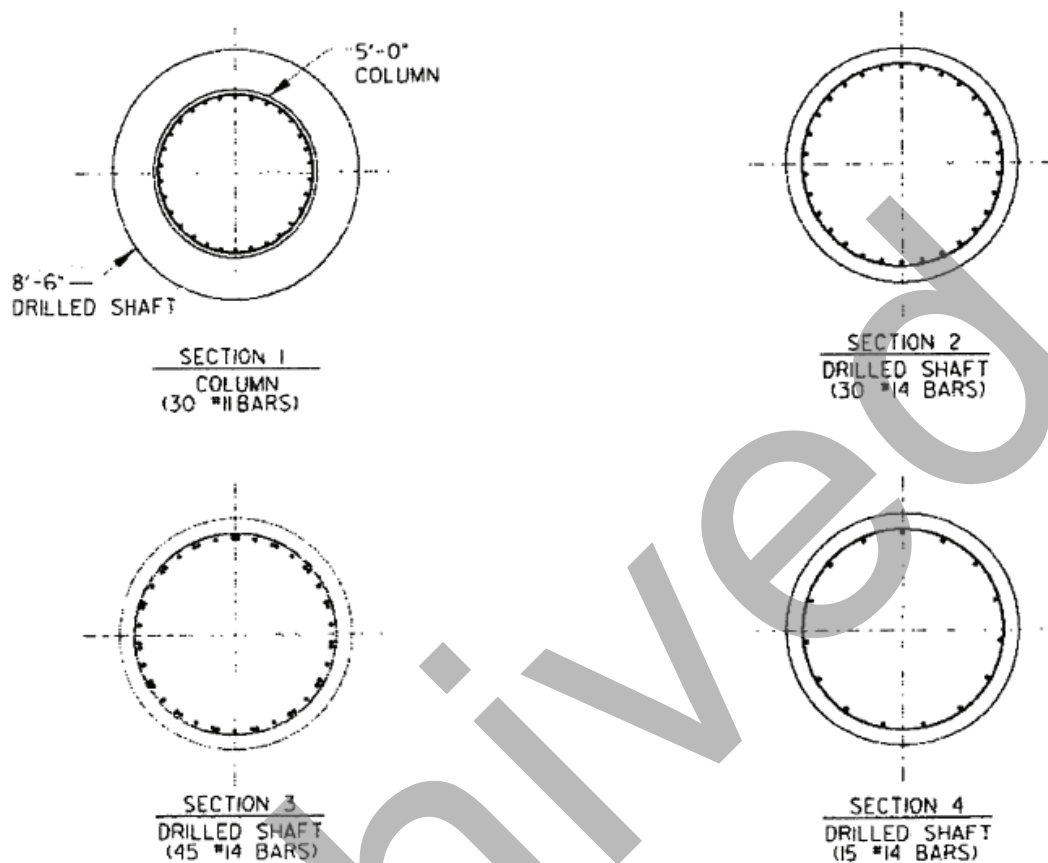


Figure 16-11 Typical Sections with Casing

Accordingly, it appears reasonable to include the effect of permanent steel casing in a moment-curvature analysis as described in Section 16.7.1. A more refined analysis would include the effects of lateral constraint provided to the concrete by the steel casing; however, the tensile yield strength of the steel casing would need to be reduced by 5 percent, while the compressive yield stress could be increased by 5 percent.

However, if one decides to count on the permanent casing as effective in resisting axial forces and bending moments, it is probably more practical to design the cased portion of the drilled shaft as a composite steel section, *i.e.* as a composite concrete-filled tube. AASHTO contains provisions for the design of composite concrete-filled tubes, which are adopted from recommendations of the Structural Stability Research Council (SSRC) Task Group 20 (1979).

The design of the cased portion of the shaft for axial compression alone should follow the provisions for composite concrete-filled tubes under AASHTO Section 6.9.5. The design for bending moment should follow AASHTO Section 6.12.2.3.2, and the design for combined interaction effects of axial compression and bending moments should follow AASHTO Section 6.9.2.2.

### 16.8.3 Structural Analysis of Plain-Concrete Underreams

The underreamed drilled shaft has become somewhat less popular in recent years due to research that has shown the effectiveness of straight-sided shafts in carrying axial loads. Also, the construction of an underream, or "bell," is difficult in some soils, and the settlement that is necessary for the underream to mobilize a reasonable value of base resistance may sometimes be more than can be tolerated by the superstructure. However, there are occasions, such as when a homogeneous stiff clay, hardpan or soft cohesive rock exists at a shallow depth, that the underream can be easily constructed and is the least expensive type of foundation. The shape of a typical underream is shown in Figure 16-12. The construction of such an underream is described in Section 4.6. As noted in Section 4.6, other shapes are possible depending on the type of tool that is employed. As can be seen by an examination of Figure 16-12, the portion of the bell that extends beyond the shaft will behave somewhat like a short, wedge-shaped cantilever beam. The soil reaction at the base of the cantilever will generate tensile stresses within the underream, with the maximum stress concentrated at the notch angle shown in Figure 16-12. If the underream has a flat bottom, the tensile stresses will have a pattern such as shown in Figure 16-13.

The possibility of the development and propagation of tensile cracks in unreinforced underreams has concerned structural engineers in the past, and these concerns have resulted in generally low allowable contact stresses, even in strong geomaterial.

To provide a rational basis for the establishment of base contact stresses from a structural perspective, Farr (1974) conducted a study of the possible tensile failure of unreinforced underreams by performing model tests in the laboratory and by making computations with the finite element method, developing relationships for guidance in design. The factors that were considered by Farr were the strength of the concrete, the toe height, the shape of the bottom of the underream, the distribution of bearing stress at the base of the underream, and the underream angle (45 degrees or 60 degrees). Those studies suggest that as long as the minimum thickness of the perimeter of the bell (toe height) is at least 3 inches, and as long as  $f'_c$  is at least 3.0 ksi, lower limits of nominal base resistance will be in the range of 8 ksf for 45-degree bells and 16 ksf for 60-degree bells where minor amounts of water are present in the base of the underream at the time of concrete placement.

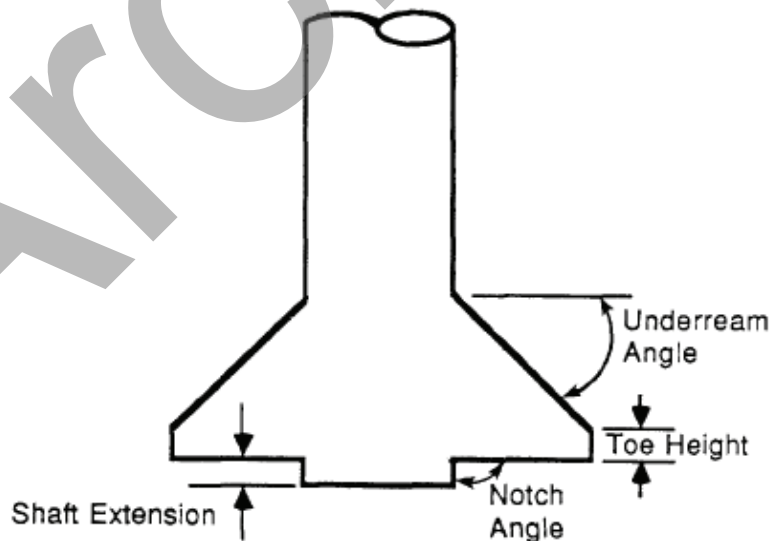


Figure 16-12 Typical Underream (after Farr, 1974)

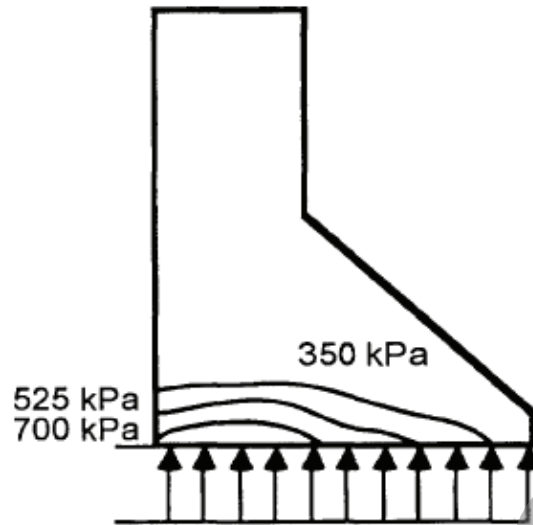


Figure 16-13 Tensile Stress Contours for Flat-bottom Bell (after Farr, 1974)

Higher base resistances than those recommended by Farr (1974) appear to be possible if the underream is embedded within a stiff clay or a soft rock. Based upon full-scale field tests on underreams, cut within stiff clay and bearing upon stiff clay or clay-shale, with diameters equal to three times the shaft diameters, the maximum average net base bearing stresses given in Table 16-2 were obtained by Sheikh and O'Neill (1988). For the test shafts, the notch had a radius of curvature of about 1 inch, bell diameters were 7.5 ft, the bearing surfaces were clean, and no water was present in the excavations at the time of concrete placement. The values in Table 16-2, which are based on the bearing stress at the onset of cracking, appear to be conservative and appropriate for design where conditions are similar to those of the study. The values given in Table 16-2 can be considered nominal values for structural resistance; however, no corresponding resistance factors or factors of safety have yet been developed for the structural design of underreams. The designer must therefore prudently choose a value for the resistance factor in the LRFD method.

**TABLE 16-2 MAXIMUM NET BEARING STRESSES FOR UNREINFORCED CONCRETE UNDERREAMS (Sheikh and O'Neill, 1988)**

Underream Angle (degrees)	Toe Height (in)	$f'_c$ (28 days) (ksi)	Net Bearing Stress at Onset of Cracking (ksf)
45	3	4.0	15
45	3	4.6	22
60	3	4.0	25
60	3	4.6	26 <sup>a</sup>

Note: <sup>a</sup> - estimated value based on extrapolation of test data with finite element model

Conditions for shaft if Table 16-2:

- Concentric axial loading against clay soil or soft clay-based rock
- Underream diameter/shaft diameter = 3
- Maximum net bearing stress correlates to the onset of cracking in the notch area

Where verification load testing is performed, it may be possible to increase the nominal bearing stress used for belled drilled shafts. For example, a load test conducted by the Chicago Committee on High-Rise Buildings (1986) indicated that 60-degree underreams with diameters in the range of 2.38 times the shaft diameter were capable of sustaining average contact pressures exceeding 35 ksf in Chicago hardpan before experiencing initial cracking.

## 16.9 SUMMARY

Structural design of drilled shafts is carried out in accordance with the provisions of Section 5 of the AASHTO LRFD Bridge Design Specifications. Section 5 covers the design of reinforced concrete structures. A drilled shaft is treated as a reinforced concrete beam-column, except for cases where bending moment is small and the shaft is laterally supported, in which case the drilled shaft can be treated as a short column. This chapter presents an overview of the LRFD design principles and a step-by-step procedure for the structural design of drilled shafts. Appendix A presents a design example that includes structural design of a drilled shaft using the step-by-step procedure presented herein.

The structural design of drilled shafts must also take into account drilled shaft constructability. This includes: adequate clear spacing to allow the flow of concrete to the outside of the reinforcing cage; convenient location of construction joints and splices; and adequate concrete cover that allows for construction tolerances. These issues are addressed in this chapter and more extensively in Chapter 8 (Rebar Cages).

## CHAPTER 17

### FIELD LOADING TESTS

“One test result is worth one thousand expert opinions”  
– Werner von Braun, rocket scientist, Huntsville, Alabama

#### 17.1 GENERAL

In spite of the most thorough efforts to correlate drilled shaft performance to geomaterial properties, the behavior of drilled shafts is highly dependent upon the local geology and details of construction procedures. This makes it difficult to accurately predict strength and serviceability limits from standardized design methods such as those given in this manual. Site-specific field loading tests performed under realistic conditions offer the potential to improve accuracy of the predictions of performance and reliability of the constructed foundations. Because site-specific field loading tests reduce some of the variability associated with predicting performance, the use of larger resistance factors are justified when loading tests are performed at the project site.

Until recent years, field loading tests on high capacity drilled shafts were quite rare due to the magnitude of the loads required to fully mobilize the resistance, as illustrated in Figure 17-1. Engineers and transportation agencies now enjoy the benefit of innovative test methods which allow cost-effective testing of foundations to loads and in ways never before possible. This chapter describes methods and interpretation of field loading tests that can be used to improve the economy and reliability of drilled shaft foundations.



Figure 17-1 Kentledge Static Load Tests with (a) Bi-directional (O-cell) Test; (b) Rapid Load Test (Statnamic) (photos courtesy Loadtest, Inc. and Applied Foundation Testing)

Loading tests are performed for two general reasons:

- to obtain detailed information on load transfer in side and base resistance (or lateral soil resistance for a lateral load test) to allow for an improved design ("load transfer test"), or
- to prove that the test shaft, as constructed, is capable of sustaining a load of a given magnitude and thus verifying the strength and/or serviceability requirements of the design ("proof test").

A load transfer test is typically designed to try to fully mobilize the resistance of the soil or rock. The test often involves instrumentation of the test shaft in order to determine the distribution of side and base

resistance (or lateral soil resistance for a lateral test). The data from such measurements can then be used to design or re-evaluate the design of the production shafts with more confidence than would otherwise be possible. Load transfer tests are most useful when performed on specific test shafts constructed in advance of production shaft installation. In this way, the load test results and lessons learned can be evaluated and incorporated into the design for optimum efficiency and reliability. Although the preferred approach is to perform load tests on non-production drilled shafts, in some instances the test shaft(s) may be incorporated into the production foundations. Where load tests are incorporated into production locations, there exists the risk of an unexpected low test result which would require mitigation of a production foundation.

Proof tests are typically designed to verify that the shafts as designed and constructed satisfy the strength and/or serviceability requirements of the project. Proof tests may be performed in advance of production or as a part of a verification program on actual production shafts. Proof tests can often provide benefits of reliability and may justify larger resistance factors, although at present there are no established procedures for performing proof tests nor AASHTO specifications addressing resistance factors for drilled shafts with proof tests.

### **17.1.1 Benefits and Limitations of Field Load Testing**

When considering the possible use of field load testing on a drilled shaft project, it is useful to weigh the potential benefits and limitations of a field load test program. The relative benefits and limitations are related to the size and scope of the project, the potential difficulty of construction of the shafts, the schedule requirements, site access, the site geology, previous experience in the local area, and the sensitivity of the design to various geotechnical parameters. In weighing the potential benefits, it is generally prudent to perform sensitivity analyses of the foundation design during the design phase to evaluate the possible range of behaviors and the impact on costs and the schedule (Blocks 10 through 15 in Chapter 11).

Projects of significant size can benefit from field load tests in the following ways:

- a. The test(s) provide a direct measure of resistance in the specific geologic formation in which the shafts will be founded.
- b. The test(s) provide a direct measure of performance using the actual construction means and methods planned for the project.
- c. The test(s) provide a means by which the design methodology can be refined in the local geologic conditions.
- d. The overall reliability of the foundation is improved because of the site-specific verification of the design and construction methods.
- e. Due to improved reliability, higher resistance factors can be used for design if field load testing is included in the project. This provides improved economy and efficiency even if no modifications to final shaft tip elevations are made after completion of testing.
- f. The economy and efficiency of the foundations can be improved if refinements to the final design can be incorporated based on the test results.
- g. Improved efficiency and possible reductions in shaft length or rock excavation can result in reduced risks of construction difficulties which could affect costs and/or the schedule.
- h. The results can provide benefit on future projects.

While the benefits are significant, limitations of field load testing must be considered and include:

- a. The results of measurements from a single or relatively few tests in a highly variable geology may be of limited benefit in evaluation of the possible variations in production shaft performance.

- b. Field load tests require a substantial investment of resources and time. If the foundation construction is on the critical path of an accelerated schedule, the impact to the schedule from delays in starting production may be more costly than the additional shaft embedment resulting from a conservative design with lower resistance factors.
- c. Projects with relatively few drilled shafts may not derive sufficient improvements in economy and efficiency to offset the costs of testing.
- d. In some cases the design may not be sensitive to or controlled by geotechnical strength considerations. For instance, scour and lateral loading may dictate that the shafts be founded in a hard rock layer which has more than sufficient axial resistance even when assessed using a very conservative approach to design with an appropriately low resistance factor. In such a case, axial loading tests would not likely represent a wise investment of resources.

Oftentimes, the benefits can be enhanced and some of the limitations listed above can be overcome with careful planning and creative use of the load testing technologies described in this chapter.

### 17.1.2 Design-Phase Load Testing Program

The greatest benefit can almost always be derived from field load testing during the design phase of the project. Design-build (D-B) type contracts are often under the combined pressures of an accelerated schedule and incentives to achieve economical solutions. The D-B team may typically work together to execute field loading tests while the design work is being completed so that the results can be used to achieve the maximum economy in the foundation design.

In conventional projects, a design-phase test program will generally require a separate contract with drawings, specifications, permits, etc. so that the work can be executed and the results implemented during final design. The benefits and limitations of this approach to field testing compared to performing the field load tests later in the project are summarized in Table 17-1.

**TABLE 17-1 SUMMARY OF BENEFITS AND LIMITATIONS OF DESIGN-PHASE FIELD LOAD TESTS**

Benefits	Limitations
<ul style="list-style-type: none"> <li>1. Results of testing can be readily implemented and design optimized for economy and constructability.</li> <li>2. Comparative tests of alternative foundation systems can be performed, e.g. drilled shafts vs driven piles.</li> <li>3. Execution of field work in advance of bidding can reduce constructability issues for potential bidders.</li> <li>4. Mitigation of constructability problems minimizes risk and therefore contingency costs in competitive bids and reduces risk of claims.</li> <li>5. Completion of field testing in advance may allow construction to proceed immediately into production upon notice to proceed and thus may reduce construction time (assuming that similar construction methods are used for production shafts).</li> </ul>	<ul style="list-style-type: none"> <li>1. Time and effort is required to prepare contract documents for a separate load testing contract.</li> <li>2. The time required to execute the testing program during design can be a problem if the project is on the “fast-track”.</li> <li>3. The costs of a separate mobilization and permits can be significant, especially if over-water work is required or if there are nearby structures, traffic disruptions, or permit issues.</li> <li>4. Some contractors may have little interest in bidding the load test contract if the magnitude of the contract is small and if they feel that they have a competitive advantage in their construction techniques that they wish to keep confidential.</li> <li>5. The performance of the test shafts may vary from the performance of production shafts if different methods of construction are used.</li> </ul>

### 17.1.3 Field Load Testing Program at the Start of Construction

Most field loading tests are conducted during the construction phase of the project, after completion of final design but prior to start of production shaft installation. Although a design is completed at the time of the field load tests, the economic benefits of using the higher resistance factor associated with load testing can be used since the design is completed with the knowledge that field load tests will be performed. It is usually possible to incorporate some changes such as adjustments to shaft tip elevation that can provide additional benefit from the standpoint of economy and/or reliability. Note that an add/deduct price can be included in the contract for adjustments to length. The owner will not generally derive as much economy from reductions in shaft length as would be the case for a design-phase test program because the contractor's equipment must be sized for the maximum length and size of shaft that might be anticipated prior to the start of the project, and the contractor may have increased contingency in their bid.

The benefits and limitations of this approach to field testing compared to performing the field load tests during the design phase of the project are summarized in Table 17-2.

**TABLE 17-2 SUMMARY OF BENEFITS AND LIMITATIONS OF FIELD LOAD TESTS AT THE START OF CONSTRUCTION**

<b>Benefits</b>	<b>Limitations</b>
<ol style="list-style-type: none"> <li>1. Design benefits from the use of higher resistance factors associated with load testing because of the assurance that field tests will be performed.</li> <li>2. No separate mobilization or contract; requirements can readily be incorporated into the project specifications.</li> <li>3. Provides an opportunity to evaluate the specific construction methodology to be used on the project with respect to effect on performance.</li> <li>4. Results can be incorporated into adjustments in shaft length.</li> </ol>	<ol style="list-style-type: none"> <li>1. Major changes to the design are not practical and there is no opportunity to test alternative foundation systems.</li> <li>2. The financial benefits of reductions in length are less than would be realized from design-phase testing.</li> <li>3. The time required for load testing on the front end of a project may impact the schedule, especially if the project is on an accelerated schedule.</li> <li>4. There is often little time to evaluate the results and make changes because of potential delays in the start of production.</li> <li>5. The contractor must bid on, size equipment for, and provide contingency for the least favorable conditions anticipated in advance of field load testing.</li> </ol>

### 17.1.4 Proof Tests on Production Shafts

The preferred method of load testing is to perform load tests on drilled shafts constructed in advance of production installation; however, whether or not field load tests have been performed in advance of production shaft installation, proof tests on production shafts can provide quality assurance and improved reliability. Although the results cannot be readily implemented via design changes, the tests provide a verification of drilled shaft performance which includes the effects of the specific construction means and methods used on the project with minimal impact to the schedule. However, an unfavorable test result on a



foundation which has already been constructed can lead to inefficient mitigation work and so designers understandably must include contingency resulting in a more conservative design when the verification testing is to come only on production shafts after construction has started. So, there is inevitably a hidden cost associated with this approach compared to load tests performed in advance of production shaft installation.

Some testing technologies may be limited or impractical due to potential adverse effects on the performance of production shafts compared to testing of a test shaft which is not incorporated into the foundation. For instance, a lateral test to large loads can produce non-reversible displacement and structural damage in flexure. A bi-directional load cell incorporated into a production shaft produces a discontinuity in the flexural reinforcement at the location of the cell. An uplift load which produces large upward displacement (more than about ½ inch) on a production shaft may have an adverse effect on the maximum side resistance which can be mobilized by a subsequent downward directed load. A test on a full size production shaft may be impractical due to the size and load required. These limitations do not preclude load tests on production shafts, but may limit the amount of useful information that can be obtained from such tests in some circumstances.

Proof tests may also be used in conjunction with pre-production tests to provide verification and quality assurance. In this way, proof tests can be used to evaluate variability in site conditions or construction methods. Shafts which have been constructed with some apparent deficiency can sometimes be evaluated with proof tests in lieu of expensive mitigation. Some methods of proof testing (described in more detail later in this chapter) are illustrated in Figure 17-2. In Figure 17-2a a dynamic load test was performed on a drilled shaft after the pier was constructed; in Figure 17-2b a rapid load test was performed directly on a production drilled shaft.

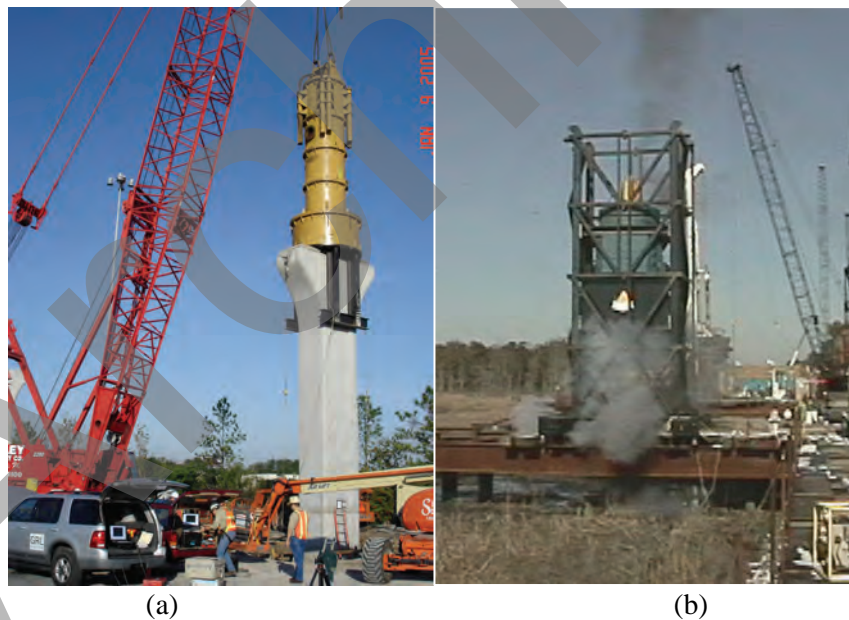


Figure 17-2 Proof Tests on Production Shafts can Verify Axial Resistance

The benefits and limitations of proof testing compared to performing the field load tests prior to production shaft installation on the project are summarized in Table 17-3.

**TABLE 17-3 SUMMARY OF BENEFITS AND LIMITATIONS OF PROOF TESTS ON PRODUCTION SHAFTS**

<b>Benefits</b>	<b>Limitations</b>
<ol style="list-style-type: none"> <li>1. May justify use of higher resistance factors in design</li> <li>2. No separate mobilization or contract; requirements can readily be incorporated into the project specifications.</li> <li>3. Provides an opportunity to evaluate the specific construction methodology to be used on the project with respect to effect on performance.</li> <li>4. Minimal impact on the schedule.</li> <li>5. A test on a questionable shaft can be performed to verify performance.</li> </ol>	<ol style="list-style-type: none"> <li>1. Test procedures and design resistance factors are not currently addressed in the AASHTO LRFD Specification</li> <li>2. Changes to the design are not practical after production shafts are installed</li> <li>3. The costs associated with an unfavorable test measurement necessitate a more conservative and thus more expensive design.</li> <li>4. If an unfavorable result is observed, remediation of a production foundation may be required.</li> <li>5. Possible effects of testing on production shaft performance must be considered.</li> <li>6. Load tests on full size production shafts may be impractical due to size and loads required.</li> </ol>

**17.1.5 Field Load Testing for Research**

Field load tests performed at representative locations within a geologic area can provide lasting benefits to a transportation agency through development of improved design methods and more reliable design parameters. Research-quality tests also afford an agency the opportunity to involve local universities and perhaps incorporate extensive instrumentation and measurements, as illustrated in Figure 17-3. In order that substantial benefit is derived from the investment in research quality field load tests, several challenges must be addressed, as follows:

- a. The tests must be performed in a geological setting that is representative of conditions that are anticipated on future projects. Selection of an appropriate site may be the most challenging, but also the most important, aspect of the research.
- b. The tests must be performed with construction procedures that are representative and typical for future projects.
- c. Funding of field load tests from an agency’s usually small research budget can be very difficult. If the research type tests can be incorporated into an upcoming construction project, then much of the costs of the field work can be born as a part of the construction work, and the research funds used to extend the benefit of the tests to future projects. This approach is an effective way for state and local transportation agencies to involve faculty and students from state universities in practical projects with research opportunities.

**17.2 LOAD TESTS TO MEASURE AXIAL RESISTANCE**

This section provides an overview of the most important considerations in planning field load tests to determine axial resistance of drilled shafts, along with a description of various methods for performing axial load tests, instrumentation for measurement of the performance of the shaft, and methods for interpreting the results of axial load tests.



Figure 17-3 Instrumented Research Load Test

## 17.2.1 General Considerations in Planning Axial Load Tests

Field load tests of drilled shaft foundations require a substantial investment of time and money, and therefore must be planned carefully to provide useful information. The overall objectives must be established and the details of the test program defined with appropriate consideration of the production shafts that the test is intended to model. A discussion of objectives and many of these important details follows.

### 17.2.1.1 Overall Objectives

The first step in planning axial load tests is to define the most important objectives of the testing program. Usually, the most important objectives relate to measurement or verification of the design parameters that are most critical to the foundation performance. These parameters should be identified during the design process (Block 11 of the overall design process from Chapter 11) by performing parametric studies of the sensitivity of the design to various resistance components if not intuitively obvious. For instance, if 95% of the axial resistance is derived from the rock socket, then the focus of the axial load testing will be upon the rock formation and its properties, while the character of the overburden is of little consideration. If the majority of the axial resistance is derived from end bearing on rock, then the important factors for the load test will be those relating to the character of the rock immediately below the test shaft compared to production shaft locations and the cleanliness of the rock bearing surface; the embedded length into rock will be of secondary importance. If the drilled shaft derives most of the axial resistance through side shear, then the effect of the installation methods, drilling fluid, and exposure time may be primary considerations for the load test shaft. A plan for instrumenting the shaft may be very important in order to determine the distribution of load transfer in side shear so that the design can be refined.

A list of possible objectives from axial load tests is provided below. This list is by no means exhaustive, and additional project-specific objectives may be identified.

- Determine base resistance at a representative location in the bearing stratum
- Determine base resistance using a specific construction method and level of bottom-hole cleanliness
- Determine side resistance in a rock socket at a representative location in the bearing formation
- Determine side resistance with a specific construction method and drilling fluid
- Determine side resistance after the maximum allowed exposure time to drilling fluid
- Determine side resistance after the maximum allowed exposure time of an open hole in a rock which is prone to weathering and degradation
- Determine the benefits of sidewall grooving to side resistance (might include tests with and without grooving, for instance)
- Determine the distribution of side resistance in various strata, each of which may contribute to the total resistance
- Determine the side resistance at large axial displacement to verify that strain softening and brittle behavior does not occur
- Determine the contribution to side resistance of a portion of the shaft within permanent casing
- Determine the axial resistance below the scour zone by separating the portion of resistance above the design scour elevation
- Determine the effect of base grouting on base resistance in a representative location with specific grouting parameters (might include tests with and without grouting, for instance)
- Determine shaft load versus displacement relationships for both side and base resistance

In addition to the primary objectives related to axial resistance, secondary objectives might also be identified. Some secondary objectives might include issues relating to constructability of the drilled shafts, assessment of drilled shaft installation methods, effect of construction on nearby structures or vice versa, concrete mix performance, and others.

It is important that the primary objectives of the load test program be identified in the contract documents so that participants in the work who were not directly involved in the design are aware and contribute to the achievement of these objectives. These participants include the constructor, the inspectors, the testing specialists, the resident engineer, and possibly others.

#### **17.2.1.2 Location and Number of Test Shafts**

The current (2007) AASHTO design guidelines provide for increased resistance factors in design based on the number of load tests per site and a characterization of the variability of the site. A “site” may be defined as a portion of the area where a structure or structures are to be located. An understanding of the geology and stratigraphy of the project area is critical to determination of the appropriate number of load tests and/or delineation of more than one “site” for purposes of testing and interpretation of test results.

In order to relate the load test results to production shafts that are not load tested, it is necessary to match the static resistance prediction to the load test results, i.e. calibrating the static resistance prediction method. The calibration requires consideration of the geomaterial properties at the specific test location in accordance with the procedures outlined in Chapter 13 or with locally developed procedures for computing axial resistance. The calibrated static analysis method is then applied to other geologically similar locations within the site to determine the required shaft tip elevation for the load demands and specific geomaterial properties at the location of that shaft.

If the geologic or stratigraphic variation across the project area is so large that the extrapolation of a load test from the tested location to another production shaft location would be inappropriate, then it is necessary to delineate the project area into more than one site for purposes of load testing. This determination requires judgment on the part of the design professional, as there is no simple definition of how much variability can or should be incorporated into a single site. Some general guidelines are offered below. A location should probably be considered a different site if any of the following are true:

- The geologic character of the predominant bearing formation is different; e.g., sandstone instead of shale, sand instead of clay, etc.
- The average calibrated resistance (unit load transfer in side shear or end bearing) in the zone providing the majority of the axial resistance varies from the test location by a factor of two or more,
- The location is more than 2,000 ft from the test shaft location,
- At each of the main piers of a long span bridge where there is a large number of drilled shafts in each pier foundation, particularly where the geology may differ on either side of a natural drainage feature.

It may or may not be prudent to consider additional tests at additional sites. As an example, consider the case of a long bridge with a low level approach or ramps leading to high bridge crossing a river. The major bridge structure might have load tests at the main pier locations and no tests at a site representative of the less heavily loaded low level approach or abutment locations. These less heavily loaded structures might bear in a different (presumably shallower) stratum and be designed with a lower resistance factor while the more heavily loaded foundations are designed based on calibration to a site specific load test. The heavily loaded portion of the bridge might even be delineated into two different sites as a result of different geology on each side of the river.

In general, multiple tests for a specific project would be associated with the delineation of multiple sites, with a single test performed at each site. Multiple tests at an individual site might be required in order to achieve multiple objectives at that site, as outlined in the previous section. For example, tests to evaluate shafts with and without sidewall grooving or two different construction methods or end bearing resistance in two different potential bearing strata, etc. Multiple tests should be considered for long span bridges, as noted above.

### **17.2.1.3 Geo-Material Properties at Test Location**

In order to appropriately interpret the results of an axial load test and calibrate the static resistance prediction method and design parameters, it is essential that the geomaterial properties at the specific test location be known with a high degree of confidence. The determination of geomaterial properties at the test location is accomplished using site investigation techniques such as borings or soundings and from careful observation of the test shaft excavation.

A boring at the specific load test location is necessary, and the excavation of the test shaft should be carefully logged to verify consistency with the stratigraphy identified in the boring. A comprehensive program of in-situ and laboratory testing is required at the specific test shaft location to correlate axial resistance measurements with known material properties. Tests of representative rock core samples and detailed visual classification of the recovered rock cores are particularly important, since the strength of rock can exhibit significant variability.

Important geologic features may also be observable during excavation of the test shaft to a greater degree than is possible from a small diameter boring or rock core. Features such as boulders, irregular rock surface,

cemented layers, and soft or weathered layers may be more readily distinguished during construction than during the site investigation, and these features may have an impact on the interpretation of the test results. In some weathered rock formations, it may be valuable to log the progress of the shaft excavation to correlate drilling rates with the degree of weathering. In this manner it may be possible to delineate zones of weak versus strong rock from the drilling activity, and more effectively correlate the load test results with performance of production shafts using inspection observations. Figure 17-4 shows material being removed from a rock coring bucket for visual examination.



Figure 17-4 Observation of Test Shaft Excavation Helps Define Geologic Conditions

#### 17.2.1.4 Scour or Changes in Overburden Stress Conditions

There can be differences in stratigraphy and in overburden stresses between the test shaft and production shafts at other locations or for some design conditions due to grade changes or scour. In addition to the elimination of some layers which could contribute to axial resistance in the test shaft, changes in confining stress in the bearing zones can have a significant effect on the axial resistance. For these reasons, it is desirable to perform load tests on shafts at or near final grade if possible. For cases with future scour or where tests are performed in advance of mass grading it may not be possible to load test the shaft under conditions similar to those of the final production shaft, and some accommodation is required. It is often possible to separate axial resistance from scourable overburden from the test shaft by using an isolation casing or by determining the resistance in these zones from strain gauge instrumentation. The effects of changes in stress within the bearing strata on the axial resistance of the shaft must also be rationally assessed and included in the interpretation of the results, as discussed in Section 17.2.4.

### 17.2.1.5 Construction of Test Shaft

Since construction techniques can have a significant effect on the measured axial resistance, the test shaft must be constructed in a manner consistent with that to be used on production shafts. For this reason, it is advisable that a test installation (often referred to as a “technique shaft”) be performed prior to installation of the load test shaft so that any questions relating to final installation methods can be resolved in advance. Some factors that are considered to be important include:

- Drilling fluids. As discussed in Chapter 7, there can be differences in side resistance for different drilling fluids (bentonite, polymer, or water) in some soil or rock formations.
- Use of casing. The use of casing, especially casing which is advanced ahead of the shaft excavation, can have an effect on sidewall roughness and the lateral stresses around the shaft. The type of casing, method of advancement, and the presence of cutting teeth on the leading edge of the casing can influence the axial resistance.
- Drilling tools. An auger or digging bucket may result in different sidewall roughness than a coring barrel, and such differences can affect axial resistance. The test shaft excavation should be accomplished using similar tools to those used on production shafts.
- Bottom conditions. The tools used to excavate and clean the shaft base should be similar to those used for production shafts. The degree of cleaning at the base should be consistent with, but not superior to, those used for production in order that the measured axial resistance is consistent with production shafts. The use of sophisticated inspection tools such as downhole cameras may be used to verify cleanliness and, in some cases, “calibrate” more routine inspection methods such as sounding.
- Time the excavation is open. Since some soil or rock formations can weather or decompose in the presence of air or fluid after the shaft excavation is complete, the test shaft program should be designed to capture any such effects which are unavoidable on production shafts. For instance, if the installation plan or the specification for production shafts allows 2 days to clean the base, place the reinforcement, and place the concrete after excavation of a rock socket in shale, then the test shaft should be constructed under similar circumstances.

The inspection and observation of the test shaft excavation is an important component of documenting the geologic features and ground conditions at the specific test shaft location, as discussed in Section 17.2.1.3.

The “as-built” dimensions of the test shaft are important for interpretation of the test results, particularly if any significant deviations from the planned dimensions are observed. The actual shaft dimensions also affect the calibration and interpretation of strain measurements. Concrete volume measurements should be routinely obtained as a part of the inspection process, as described in Chapter 19. Careful measurements of concrete volume placed as a function of height in the shaft provide a means to determine the average area of the cross section over the shaft length between measurements. However, the as-built conditions obtained from concrete volume measurements are not very precise, and a borehole caliper provides a more effective means to determine the actual test shaft dimensions. Borehole caliper measurements are recommended for test shafts.

Borehole calipers can be either the mechanical type with outreaching arms to “feel” the side of the hole, or a modern sonic caliper which remotely senses the borehole wall from a suspended probe. Examples are illustrated in Figure 17-5.

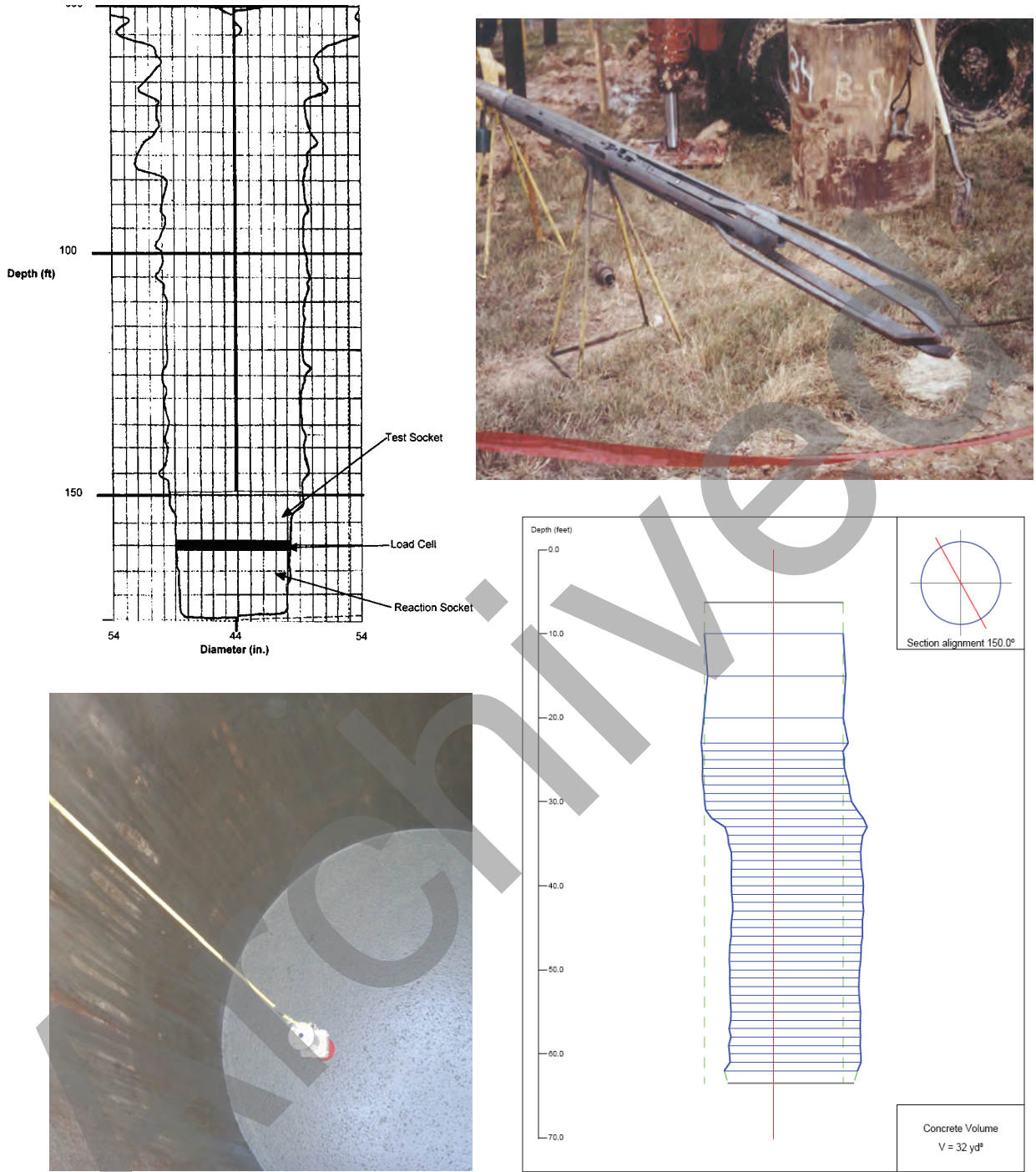


Figure 17-5 Example Borehole Calipers & Logs; Mechanical (top) and Sonic (bottom)



### 17.2.1.6 Use of Prototype Shafts

The magnitude of loads required to fully mobilize the resistance of large, high capacity drilled shaft foundations can make tests on production size shafts impractical in some instances. If prototype shafts are to be considered for use as load test shafts, some general guidelines are suggested below.

- The test shaft should be at least ½ the diameter of the production shaft and should not be less than 30 inches diameter (unless the production shaft diameter is less than 30 inches).
- The test shaft should be constructed using similar tools and construction techniques, as described above in Section 17.2.1.5. In some cases the exposure time of an open or slurry filled hole is important and should replicate exposure time of the full-size production shaft.
- The displacements at which unit values of side and base resistance are mobilized should be interpreted with respect to diameter as described in Chapter 13 in order to extrapolate to the anticipated performance of production size shafts.

Even if the guidelines above are followed, the use of prototype test shafts introduces additional uncertainties regarding the direct measure of the performance of a full size production shaft. Load tests should be conducted on production sized shaft whenever possible or practical.

Besides the different displacement required to mobilize unit base resistance related to shaft diameter, the zone of influence below the base of a smaller diameter test shaft is less than a larger production shaft. Therefore, the relative influence of stratigraphy below the base could be a factor affecting maximum unit end bearing between shafts of different diameter.

There is evidence that very small diameter shafts (such as micropiles) may have significantly greater side shearing resistance per unit area compared to the much larger sizes typical of drilled shafts (Lizzi, 1983; O'Neill et al, 1996). The effect of diameter on unit side resistance is considered to be more significant in rock, and relatively minor in soil.

The effect of diameter on mobilized resistance is thought to be largely related to the effect of sidewall roughness and dilatancy, and the effect of dilatancy on the radial stresses generated as the shaft resistance is mobilized. Dilatancy would be expected to produce an increase in normal stress at the shaft/rock interface which is greater for a smaller diameter shaft compared to a larger one having a similar magnitude of sidewall roughness. However, for large diameter shafts this effect is expected to be small. Presented on Figure 17-6 are the results from an analytical study of this effect by Baycan as reported by Miller (2003). This figure suggests that one would expect little difference in maximum unit side shear between a 4.9 ft (1500 mm) diameter shaft and a 6.6 ft (2000 mm) diameter rock socket.

The simple methods outlined in Chapter 13 for design of drilled shafts for axial loads do not specifically account for the effect of diameter on axial resistance in side shear. However, some axial computation methods suggest that there could be an inverse power relationship between shaft diameter and maximum unit side shear for “rough” rock sockets. For example, Horvath et al (1983) proposed a relationship for artificially roughened sockets in rock as indicated in Equation 17-1:

$$f_{\max} = 0.8 \left[ \frac{\Delta r}{r} \left( \frac{L'}{L} \right) \right]^{0.45} q_u \quad 17-1$$

where:  $f_{max}$  = maximum unit side shear  
 $q_u$  = compressive strength of rock  
 $\Delta r$  = height of asperities or grooves in sidewall  
 $r$  = radius of shaft  
 $L'$  = distance along surface of socket  
 $L$  = length of socket

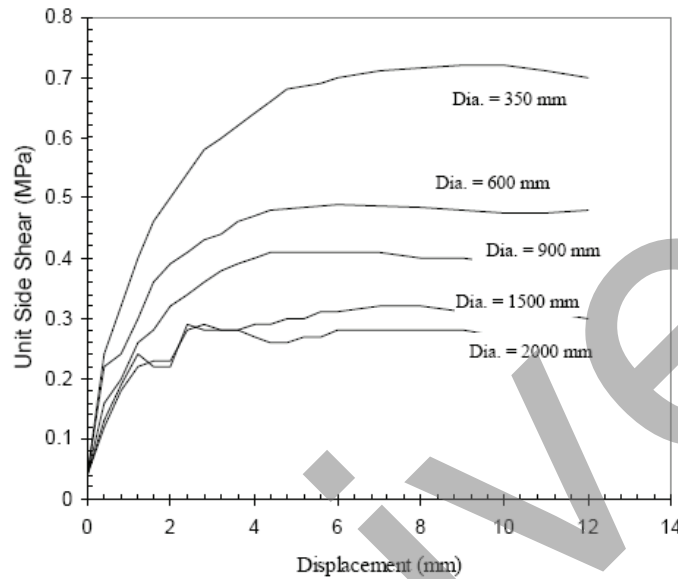


Figure 17-6 Unit Side Shear vs Displacement for Drilled Shaft Sockets in Rock of Moderate Roughness with  $q_u = 450$  psi (Miller, 2003; Baycan, 1996); 1 inch = 25.4mm, 1MPa  $\approx$  147 psi

For a given magnitude of sidewall roughness, the relationship of Equation 17-1 would suggest that the maximum unit side shear in a prototype shaft relative to a larger production shaft would be as illustrated on Figure 17-7. The data from Baycan cited above are also plotted relative to the 6.28-ft (2,000-mm) diameter socket, and indicate excellent agreement for shafts in the 1 to 6-ft diameter range with the trend predicted using the Horvath equation.

The data and relationship plotted in Figure 17-7 were developed for shafts in rock which have significant roughness and would be expected to exhibit significant dilatancy at the shaft/rock interface. The data are limited to a maximum shaft diameter of 6.3 ft. The trend for smoother sockets or for shafts in soil is likely to exhibit a less significant effect of diameter, and the trend shown might reasonably be considered as an upper bound.

The magnitude of load required to perform a top-down test on a high capacity shaft can be many thousands of tons. Bi-directional testing (described in Section 17.2.2.2) provides a means of testing high capacity shafts by using an embedded jack to engage the side resistance as a reaction against the base resistance. However, if the base resistance greatly exceeds the available side shear, then it may be impossible to load a production size shaft and fully develop the base resistance during the test. Since the area available for side resistance is proportional to the shaft diameter, while the area available for base resistance is proportional to the *square* of the shaft diameter, it may be possible to balance the anticipated base and side resistance in a test shaft by using a smaller diameter.

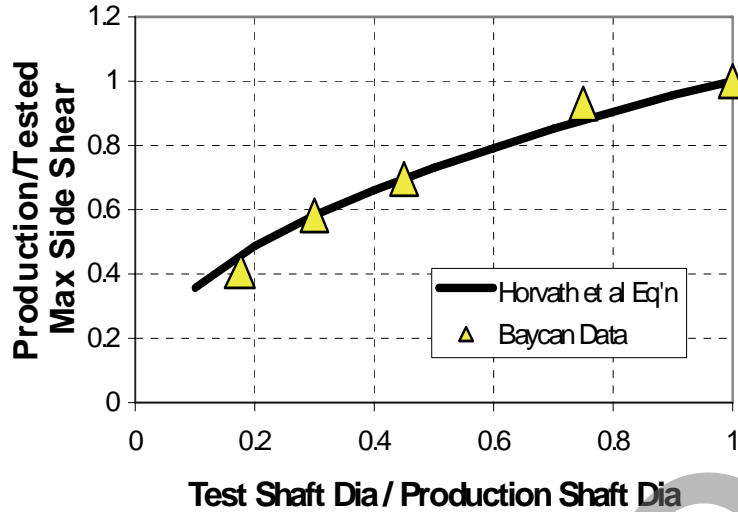


Figure 17-7 Computed Relationship Between Shaft Diameter and Maximum Unit Side Shear Resistance for Rock Sockets

Another possible solution to testing a drilled shaft with large base resistance is to utilize bi-directional testing with a production size shaft in side shear as a reaction against a smaller base area. This approach might be particularly effective in testing a shaft extending through soil overburden to engage end bearing on rock. Commonly called the “Chicago method”, a schematic diagram of this type of test is illustrated in Figure 17-8 for a test of a rock socket with limited embedment. For the test shaft shown in that figure, the bi-directional cell acts by pushing the 36-inch diameter base area against the side shear of a socket which is 48 inches diameter. Additional details of this approach are described in Section 17.2.2.2.

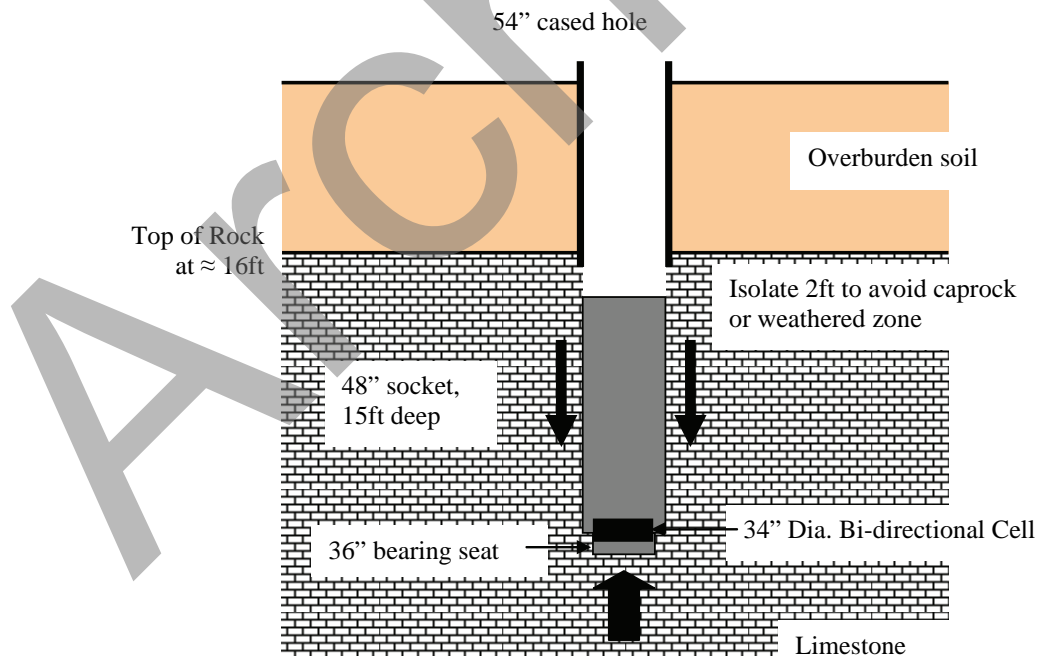


Figure 17-8 “Chicago Method” Load Test using Bi-directional Cell

The interpretation of a test performed as illustrated in Figure 17-8 would require that the load versus displacement relationship for the smaller prototype base be adjusted for the diameter of the production shaft in order to combine with the side shear and compute the overall load versus displacement response of the production shaft. More information on the interpretation of load test data is provided in Section 17.2.4.

### **17.2.1.7 Group Considerations**

If the production shafts are to be installed in groups, it should be recognized that their behavior may be different from that of an isolated single load test shaft. Although tests on groups of relatively small diameter shafts might be performed as a part of research testing to evaluate group effects, tests on groups of drilled shafts are rare due to the magnitude of load required and the costs to perform such tests. Adjustments to the anticipated load-displacement behavior of shafts in a group from that of a single shaft should be made following the general guidelines and procedures outlined in Chapter 14.

## **17.2.2 Test Methods**

The predominant methods used for load testing drilled shafts include conventional top-down static loading tests with a hydraulic jack and reaction system, bi-directional testing using an embedded jack, top-down rapid load testing using an accelerated reaction mass, and high strain dynamic load testing using a drop weight impact. Each of these methods has advantages and limitations in certain circumstances and experienced foundation engineers (like mechanics) know how to use all the tools in their toolbox. A brief description of each of these methods is provided below.

### **17.2.2.1 Conventional Top-Down Loading Test**

The most reliable method to measure the axial performance of a constructed drilled shaft is to apply static load downward onto the top of the shaft in the same manner that the shaft will receive load from the structure. Static load testing of deep foundations has a long history and is described in FHWA-SA-91-042 (Kyfor et al, 1992). Tests should generally be performed in accordance with ASTM D1143. For small diameter (3 to 4 ft) shafts in soil, conventional static load testing to loads of up to 1,200 tons can be performed in a reasonably economical manner. Conventional static load tests have been performed on occasion to loads of up to 4,000 tons. However, the high load capacity and large diameter of many drilled shafts limit the ability to perform conventional static load tests because of the load requirements imposed on the reaction system.

#### **17.2.2.1.1 Reaction System**

The most common reaction system used with a conventional static load test is comprised of a reaction beam with an anchorage system, as shown in Figure 17-9. This photo is of a 1,200 ton capacity load test. The key components of the reaction system that affect the load capacity of the test include the reaction beam, the anchorage, and the hydraulic jack used to apply the load. The loads and stresses in the reaction beam and anchorage can be very large and the entire reaction system should be designed by a professional engineer who is experienced with load testing.

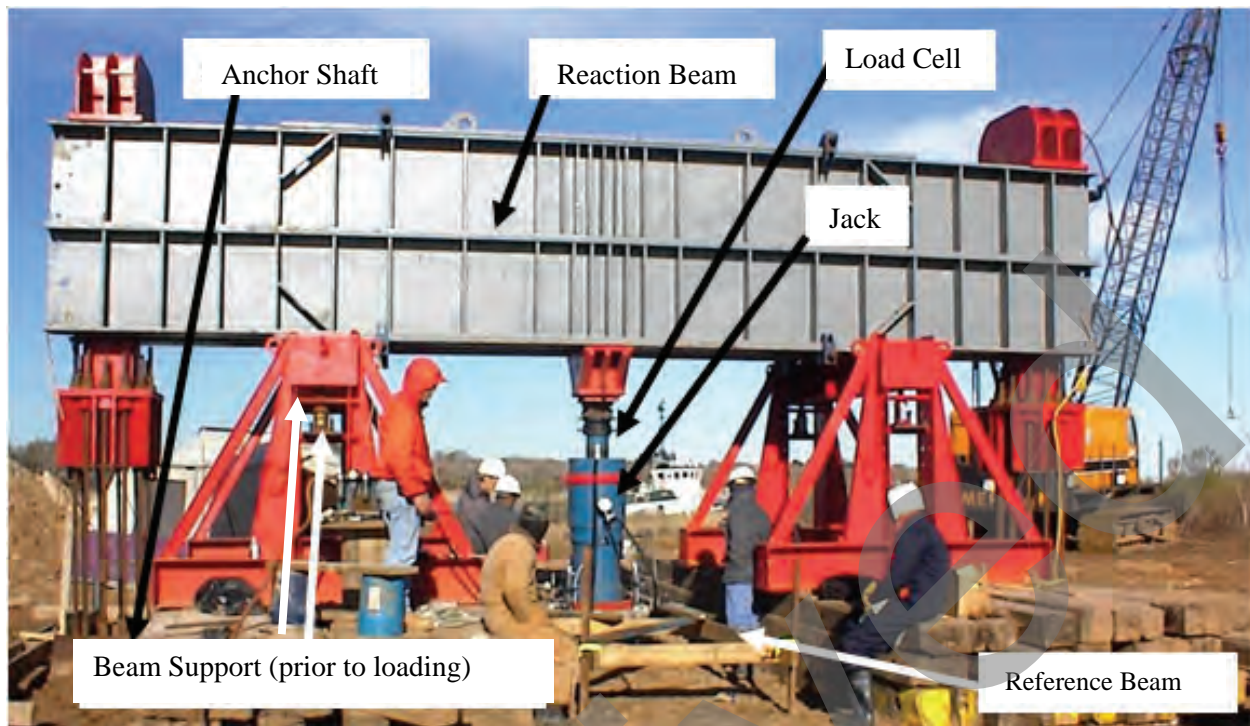


Figure 17-9 Conventional Static Load Test on a Drilled Shaft (photo courtesy Bill Isenhower)

The anchor foundations can consist of drilled shafts (as shown in Figure 17-9), with threaded rods used for longitudinal reinforcing), micropiles, grouted anchors, or driven piles such as steel H piles that can be extracted and salvaged. In some cases, such as the “Kentledge” tests shown in Figure 17-1, dead weight may be used as a reaction to avoid the need for anchor foundations.

Anchor foundations must be constructed so that the installation and use of these foundations does not affect the performance of the drilled shaft to be tested. Installation of driven or vibrated piles below the test shaft base can have an adverse effect on the base resistance by fracturing the bearing stratum or by causing ground subsidence of granular soils below the base. If grouted anchors are installed below the base of the test shaft, the stresses from these anchors can be superimposed on the bearing formation in the vicinity of the test shaft and affect the base resistance.

ASTM D-1143 requires that a clear distance of at least five times the maximum of the diameter of the test pile or anchor pile must be maintained between the test pile and anchor piles. This requirement can be impractical to achieve for large diameter drilled shaft foundations. A spacing of 3.5 diameters is recommended as a more feasible alternative, provided that the adverse affects of reaction pile installation cited above can be avoided.

The location of the anchor foundations affects the length of the beam, and the bending stresses in the reaction beam increase dramatically with the span length. For large shafts and large loads, a system of four or more reaction shafts with a multiple beam reaction frame may be used, such as the 4,000 ton capacity system employed by Caltrans and illustrated on Figure 17-10. And just to illustrate the extremes of testing, the photo in Figure 17-11 is the largest static load test of a drilled shaft known to the authors, a 5,700 ton test performed in Taiwan.



Figure 17-10 4,000 ton Capacity Reaction System (photo courtesy of Caltrans)



Figure 17-11 5,700 ton Capacity Load Test in Taiwan (photo courtesy Prof. San-Shyan “Sonny” Lin)

The reaction system must also be designed to avoid twist or eccentric loading in the reaction beam(s) during the activation of the hydraulic jack(s). This requirement is much easier to accomplish if the reaction anchors are designed to allow horizontal adjustment of the beam so that it can be centered and leveled over the test shaft. If only two reaction shafts are used and the reaction beam positioned directly over the reaction shafts, the beam may not line up precisely over the test shaft. If the jack is not precisely perpendicular to and

centered on the reaction beam, then the beam will tend to twist and apply eccentric forces to the jack, load cell, and any bearing plates within the system. Eccentric forces in the jack and load cell can damage the equipment and produce inaccurate and unconservative measurements. In addition, eccentricity in the loading system is dangerous and can cause plates or other pieces to be ejected due to the stored strain energy in the system.

#### **17.2.2.1.2 Loading Procedures**

The recommended loading procedure for static testing follows the ASTM D1143 “Procedure A: Quick Test” loading method. This procedure requires that the load be applied in increments of 5% of the “anticipated failure load” which should be interpreted as the nominal axial resistance of the shaft. Each load increment is maintained for at least 4 minutes but not more than 15 minutes, using the same time interval for all increments. After completion of the test, the load should be removed in 5 to 10 equal decrements, with similar unloading time intervals. Other loading procedures are optional, including maintained loading, constant rate of penetration, and others.

Load, displacement, strain, and any other measurements should be recorded at periods of 0.5, 1, 2, and 4 minutes and at 8 and 15 minutes if longer intervals are used. Periodic measurements of the movements of the reaction system are also recommended in order to detect any unusual movements which might indicate pending failure of an anchor shaft or other component. A discussion of measurements and instrumentation is provided in Section 17.2.3.

#### **17.2.2.2 Bi-Directional (O-cell) Testing**

The bi-directional loading test is performed by applying the load with an expendable jack (or multiple jacks) sandwiched between an upper and a lower load plate cast within the test shaft. The test is performed by using the upper portion of the shaft as a reaction against the base and lower portion of the shaft. Some of the first known bi-directional tests were reported by Gibson and Devenney (1972) who used a hydraulic jack placed at the bottom of a borehole in rock, and by Horvath and Kenney (1979) who performed tests using a stacked series of mining-type flat jacks embedded in a rock socket. A more effective jacking system that has been developed, patented, and has come into common use is called an Osterberg cell (commonly referred to as an O-cell®) after its inventor, Jorj Osterberg (1992, 1994). A schematic diagram of an O-cell loading system is shown in Figure 17-12. The O-cell loading system is provided in the U.S. exclusively by Loadtest, Inc.

A survey conducted by Turner (2006) indicates that the O-cell test has become very widely used by state DOT agencies, especially for drilled shafts in rock. Since an external reaction system is not required, the test can be performed to measure axial resistance on even very large drilled shafts.

The principle and operation of a bi-directional test is simple. After a shaft has been cast and the concrete has had sufficient time to gain sufficient strength for testing, the O-cell is pressurized to break the tack welds holding the cell together and to “crack” the shaft into an upper and a lower portion. The pressure may then be reapplied incrementally to begin imposing the bi-directional load to the upper and lower shaft sections. During the testing, the top shaft section provides reaction for the bottom section, and visa versa. Because the shaft must be separated at the location of the O-cell, there cannot be continuous reinforcement across the location of the O-cell.

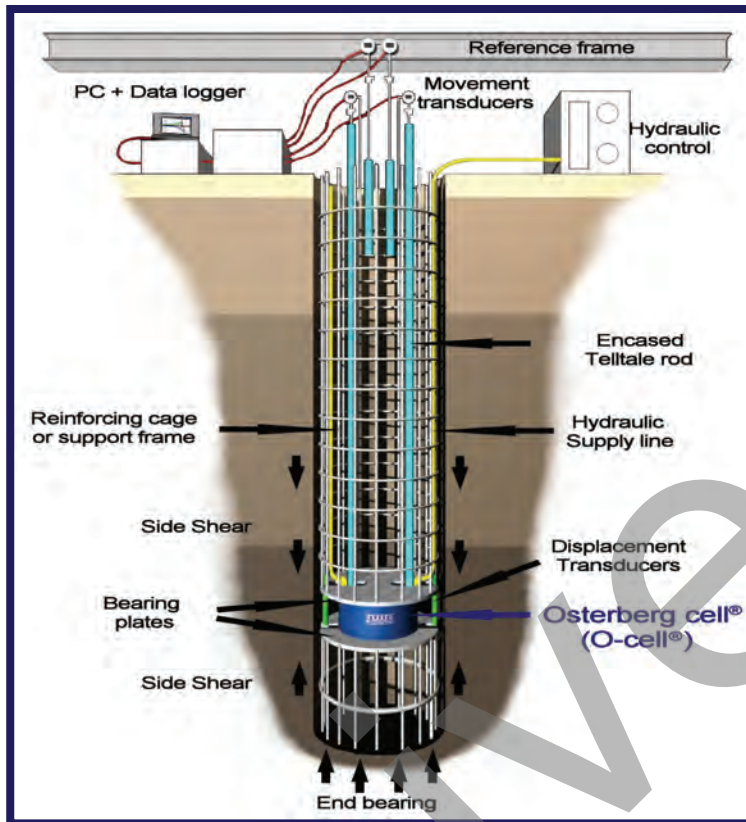


Figure 17-12 Bi-Directional (O-cell) Testing Schematic (courtesy of Loadtest, Inc.)

The maximum test load is limited to the maximum axial resistance of the shaft above or below the cell, or the maximum capacity of the cell, or the maximum expansion of the O-cells (typically 6 inches). It is therefore important that the O-cell be located at or near the point in the shaft where the axial resistance above and below the cell are approximately equal. If the side resistance exceeds the base resistance, then the O-cell should be located at the point at which the base resistance plus the side resistance below the O-cell are approximately equal to the side resistance above the O-cell. If the base resistance exceeds the side resistance, then the magnitude of the base resistance that can be mobilized during the test is limited as illustrated in Figure 17-13. The latter limitation can be mitigated in some cases using the “Chicago Method” described previously and illustrated on Figure 17-8. The designer planning the load test must make estimates of the magnitude of the resistance above and below the cell, and the successful measurement of maximum resistance values is thus dependent on the ability of the designer to place the cell in the optimum location.

On one recent project at a major bridge site in Louisiana, the base resistance (around 3,000 tons) exceeded the available side shear resistance (around 2,000 tons) and limited the ability of the O-cell loading method to mobilize and verify the magnitude of the available base resistance. The contractor employed a 1,000 ton capacity reaction frame with a hydraulic jack atop the test shaft as shown in Figure 17-14. When the upward shaft movement indicated that the side shear was at its maximum limit, the O-cell loading was paused and the reaction system engaged. The jack at the top of shaft was loaded simultaneously with the increased load on the O-cells so that the base resistance was successfully mobilized using both the side shear of the shaft plus the reaction system.



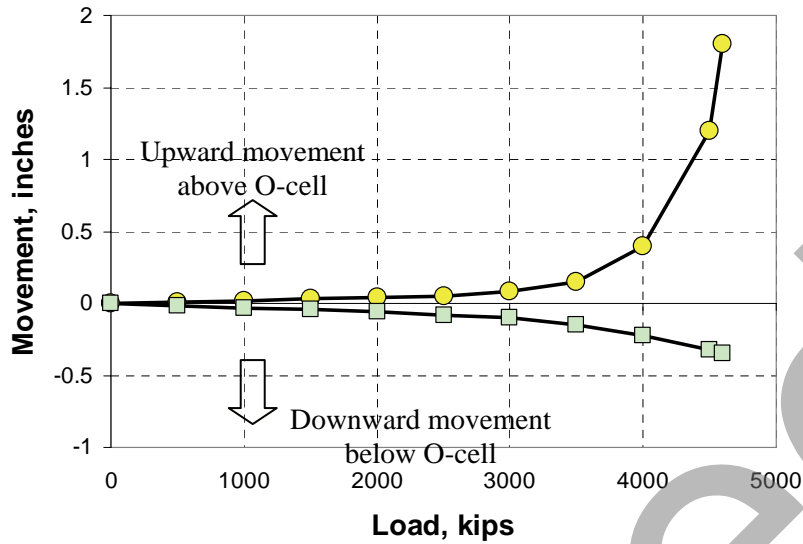


Figure 17-13 Example Test Result from Bi-Directional Test

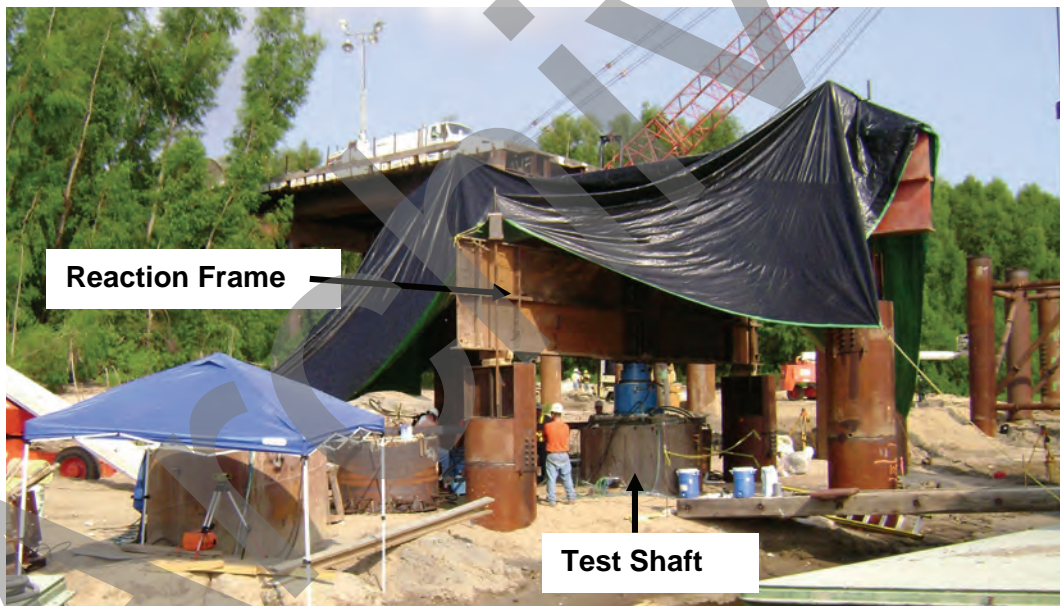


Figure 17-14 O-Cell Test with Added Reaction System

Another possible approach to O-cell testing is to use cells at multiple levels as illustrated on Figure 17-15. By performing this “multiple stage” loading, the resistance of various segments can be measured separately and the limitation of the “weakest link” can be overcome.

The ability to employ this testing technique in production shafts is limited. Since the cells must crack and separate the various sections of the shaft, bending moments cannot be transferred below the uppermost O-cell level. In addition, the large upward displacement of a section of shaft above the O-cell could be detrimental to the subsequent axial resistance of that portion of the shaft to a downward directed load in some cohesive

soil or rock materials. Measurements of axial resistance during load reversal of segments between multiple level O-cells suggest that a non-recoverable loss of axial resistance in side shear may be observed with full cyclic stress reversal at displacements greater than 1/2 inch or so. The phenomenon is likely related to remolding of cemented materials at the rough shaft/soil interface, and has not been reported with uncemented granular soils. For these reasons, it is preferred that O-cell tests be performed on dedicated load test shafts so that tests can be conducted to achieve the objective of measuring axial resistance without concern about the subsequent use of the test shaft. If O-cell tests are performed on production shafts, it is recommended that the upward movement be limited to about 1/2 inch during O-cell testing in cemented or cohesive soils or rock so as to minimize potential degradation related to cyclic stress reversal.

The following sections describe the loading apparatus and procedures used for performing a bi-directional load test and for determining the static axial resistance of a drilled shaft from the measurements.

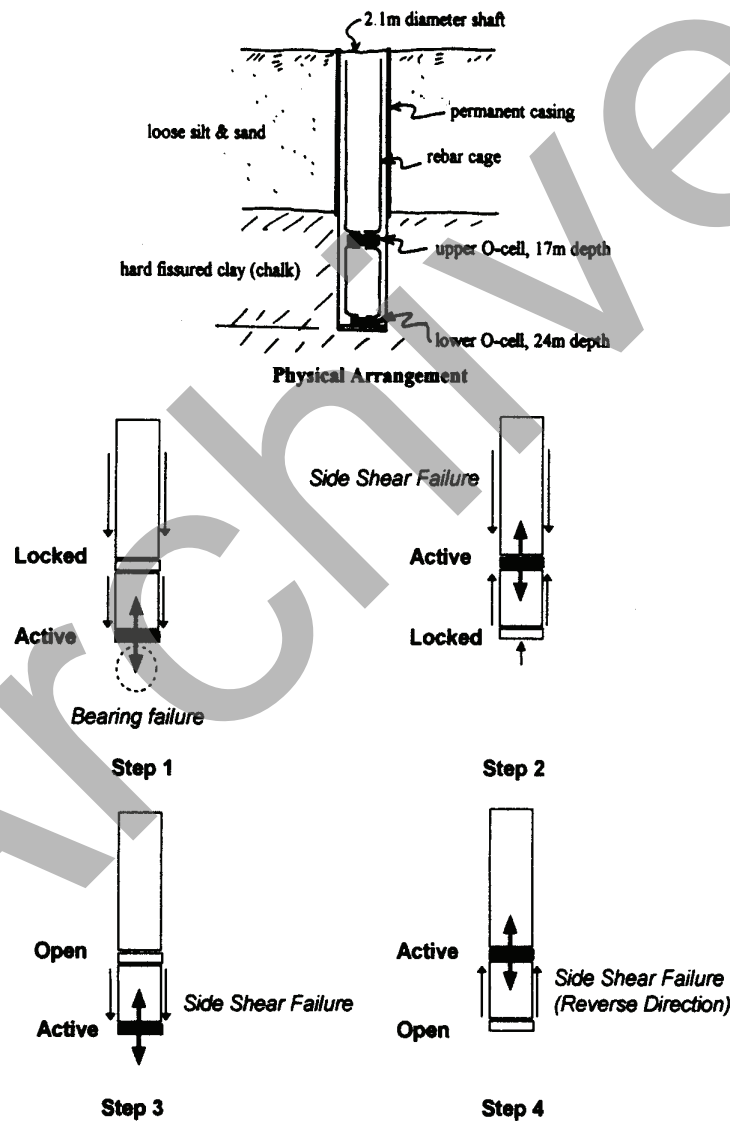


Figure 17-15 Multiple-Level Arrangement for O-Cells (O'Neill et al., 1997)

### 17.2.2.2.1 Loading Apparatus and Procedure

Single O-cells currently available range in size from 9 inches to 34 inches in diameter, and deliver total bi-directional loads of 800 kips to 12,000 kips, respectively. These cited loads are for a supplied hydraulic pressure limited to 10,000 psi. The hydraulic fluid utilized for pressurization of the O-cell(s) is water or a combination of biodegradable vegetable oil and water, thus alleviating some concerns of soil and groundwater contamination. Multiple O-cells may be combined between an upper and lower load plate to provide total bi-directional loads in excess of 12,000 kips. It would seem the only limit to the amount of load that can be delivered is the cross-sectional space available for O-cell placement. An O-cell load test was achieved in a 118-inch diameter shaft at the Incheon Bridge, Korea, with a total bi-directional load of approximately 62,700 kips. When multiple O-cells are utilized per level, it is advisable to utilize a minimum of three per level to alleviate concerns of load eccentricities and of shaft flexure causing damage to the O-cells. Typical single and multiple level O-cell assemblies are illustrated in Figure 17-16.

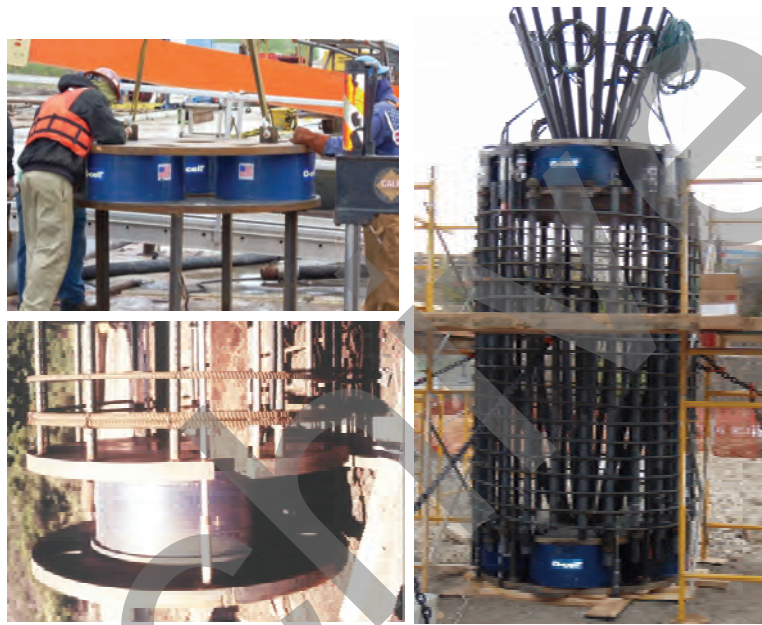


Figure 17-16 Single O-Cell (bottom left), Multiple O-Cell Assembly (top left) and Multi-Level O-Cell Assembly (right)

O-cells have an available travel (separation) of approximately 6 inches before the cells lose their seal; actual travel available is to some degree affected by the amount of eccentricity imposed to the cell. Newer models of O-cells are planned to have an option of approximately 9 inches of travel.

The upper and lower plates for the O-cell assemblies are typically around 2 inches thick, and have generous portions cut away between the O-cell locations to allow for concrete flow through the plates during concrete placement operation of shaft construction. The plates utilized are subject to the specific load conditions and geo-material present at the site being tested. The outside diameter of the load plates are typically sized such that they just fit inside the vertical rebar of the cage.

There must be no reinforcing across the plane where the shaft cracks into two segments (O-cell break plane) prior to final placement of the cage into the excavation. Often some of the rebar, or other structural steel welded in place, is left intact across the O-cell plane rather than relying solely on the O-cell factory tack welds (holding the O-cells closed) to facilitate flexural stresses experienced during the cage pick. The O-cell assemblies make the cage much stiffer at these locations, and can be subject to damage if distortion occurs when the cage is lifted. This temporary reinforcement is removed once the cage is vertical.

Construction of O-cell test shafts in a “wet” hole requires that the O-cell assemblies include some means of installing concrete below and around the cell. The photo at right in Figure 17-16 shows the “funnel” fabricated inside the cage, just above the top of the O-cell plate to help guide the tremie through the O-cell assembly. In a dry shaft, a small amount of concrete can be placed in advance to act as a leveling pad below the O-cell.

The bi-directional load being applied to the drilled shaft is usually monitored by measuring the pressure applied by the pump. The O-cells will therefore need to be calibrated in a testing machine prior to installation to obtain a relation between the measured pressure and the load applied by the cell. In practice the hydraulic pressure will usually be measured at the ground surface, but the cells are typically located at substantial distances below the ground surface (30 ft to over 200 ft). Therefore, the actual pressure at the level of the cell is the pressure that is measured plus the vertical distance from the pressure gauge to the middle of the cell times the unit weight of the fluid. This correction, while conservative if ignored, may be made before plotting load versus movement.

Displacements of the various segments being loaded in a bi-directional test must be measured separately. Separation of the O-cells (relative movement of the upper shaft section to the lower) is measured by expendable electronic displacement transducers that are placed between the O-cell plates at multiple locations around the shaft and cast into the shaft during concreting operations. “Telltals” are sleeved, unstrained rods extending to the top of the shaft from the upper and/or lower plates and are used to determine the movement of the cell relative to the top of the shaft. In order to determine the absolute movement of the shaft, the top of shaft displacement is measured relative to a stable reference beam. The telltals measure shaft compression directly, and the top of O-cell movement is the top of shaft movement summed with the shaft compression. With long cages and/or cages set in multiple sections, often only the top section is fitted with a conventional telltale that “daylights” out of the top of the shaft. Deeper shaft sections may include an embedded telltale with a sacrificial displacement transducer. Strain gages are also embedded at selected elevations within the shaft to provide measurement of load transfer at various points along the shaft. A discussion of measurements and instrumentation is provided in Section 17.2.3.

#### **17.2.2.2 Derivation of Static Axial Resistance**

The O-cell load test measurements provide a measure of the load versus displacement response of separate segments of the test shaft. Each segment is loaded in static compression, and at least one segment is loaded in the upward direction. Typical loading procedures apply load in intervals of 5% to 10% of the anticipated nominal axial resistance of the test segments, with load increments maintained for a period of 4 to 8 minutes and measurements made at 1, 2, 4, and 8 minute intervals.

Interpretation of O-cell test results on an individual segment pushed down are performed in a manner similar to any other static load test measurement. Interpretation of measurements on a segment pushed upward are similar except that the dead weight of the shaft segment is subtracted from the O-cell load to obtain a net upward load applied to the soil. Strain gauge measurements may be used to interpret load distribution within each segment as outlined in Section 17.2.3.

Interpretation of O-cell tests in short rock sockets is typically based on the assumption that the total applied load at the nominal resistance is distributed uniformly over the shaft/rock side interface, and used to calculate an average unit side resistance by:

$$f_s = \frac{Q_{oc}}{\pi BD} \quad 17-2$$

where:

- $f_s$  = average unit side resistance (stress),
- $Q_{oc}$  = O-cell test load,
- $B$  = socket diameter
- $D$  = socket length above the O-cell base.

The degree to which this average unit side resistance is valid for design of rock sockets loaded at the head depends upon the degree to which side load transfer under O-cell test conditions is similar to conditions under head loading. Detailed knowledge of site stratigraphy is needed to interpret side load transfer.

O-cell test results may be used to construct an equivalent top-loaded settlement curve, as illustrated in Figure 17-17. At equivalent values of displacement both components of load are added. For example, in Figure 17-17a, the displacement for both points labeled '4' is 0.4 inches. The measured upward and downward loads determined for this displacement are added to obtain the equivalent top load for a downward displacement of 0.4 inches and plotted on a load-displacement curve as shown in Figure 17-17b. This procedure is used to obtain points on the load-displacement curve up to a displacement corresponding to the least of the two values (side or base displacement) at the maximum test load. In Figure 17-17a, this corresponds to side displacement. Total resistance corresponding to further displacements is approximated as follows. For the section of shaft loaded to higher displacement, the actual measured load can be determined for each value of displacement up to the maximum test load (in Figure 17-17a this is the base resistance curve). The resistance provided by the other section must be estimated by extrapolating its curve beyond the maximum test load. In Figure 17-17, the side resistance curve is extrapolated. The resulting equivalent top-loaded settlement curve shown in Figure 17-17b is therefore based on direct measurements up to a certain point, and partially on extrapolated estimates beyond that point. Elastic compression of the shaft above the test segments may be computed and added to the measured displacements.

In many instances with test data similar to the example cited above, many engineers may prefer not to design for a strength limit condition at values of axial resistance extrapolated beyond the limits of the measured values in side shear. If ductile behavior in side shear is anticipated with no strain-softening (reduction in side resistance at larger displacements), then the strength limit may be taken as the maximum value achieved during the load test. For the illustration above, this approach would effectively assume that the shaft side shear is limited to the value shown at point 5 in Figure 17-17a and that the extrapolated curve above point 5 is a vertical line.

Because of the tendency for dilatancy at the rock/shaft interface, it is unusual that strain softening behavior is observed in load tests of drilled shafts. However, if the load test data are similar to Figure 17-17 and side shear at large displacements are not measured, the test does not provide a direct measure of the combined performance of side shear and base resistance at large displacement. In the event that strain softening behavior in side shear is a potential concern, it may be unconservative to extrapolate the side shear resistance measurements at limited displacement. In this case, the strength limit in base resistance may be at a displacement which is incompatible with the displacements at maximum side shear and therefore the expected top-loaded settlement curve would need to be adjusted for a reduction in side shear beyond point 5 in Figure 17-17a. If strain softening behavior is suspected, it is important that test data be obtained at large side shear displacements so that the effect can be observed and evaluated.

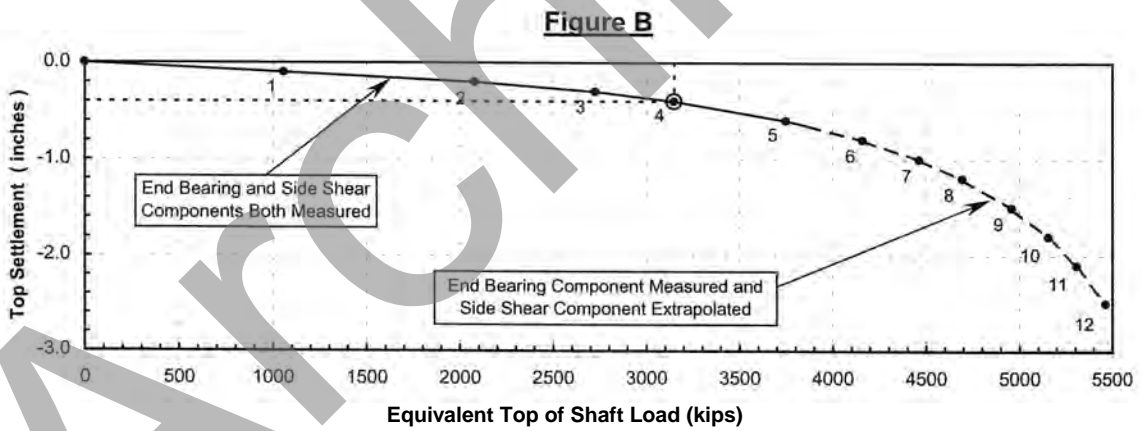
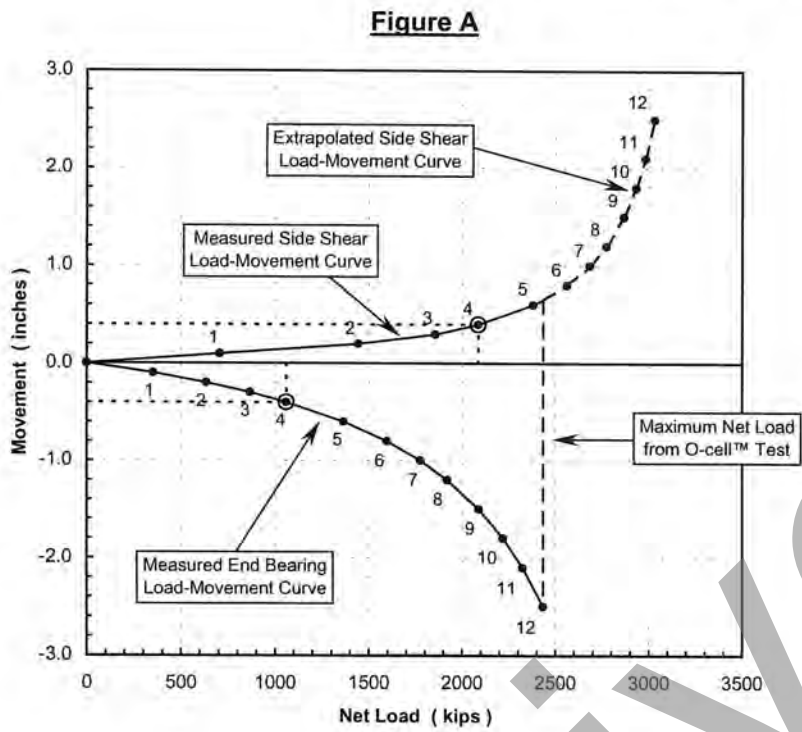


Figure 17-17 Construction of Equivalent Top-Loaded Settlement Curve from O-cell Test Results

According to Paikowsky et al. (2004), most state DOT geotechnical engineers utilizing O-cell testing tend to accept the measurements as indicative of drilled shaft performance under conventional top-down loading. O-cell test results are applied in design by construction of an equivalent top-load settlement curve, as illustrated above, or by using the measured unit side and base resistances as design nominal values. There is little evidence that drilled shafts deriving axial resistance in soil exhibit any significance difference in behavior associated with direction of loading. Figure 17-18 illustrates comparative data from the O-Cell and Kentledge (top-down) load tests that were illustrated in Figure 17-1 on two identical shafts in sandy clay soil at a site in Singapore (Molnit and Lee, 1998).

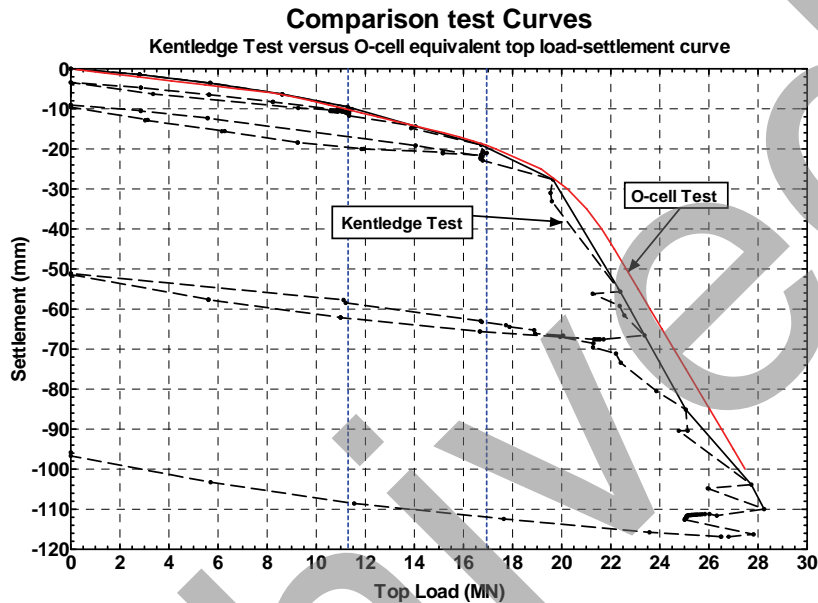


Figure 17-18 Top Down and O-Cell Load Test at a Soil Site in Singapore (1 inch = 25.4 mm; 1MN = 112 tons)

In shallow rock sockets under bottom-up (O-cell) loading conditions, a potential failure mode is by formation of a conical wedge-type failure surface (“cone breakout”). Obviously, this type of failure mode would not yield results equivalent to a shaft loaded in compression from the top. A construction detail noted by Crapps and Schmertmann (2002) that could potentially influence load test results is the change in shaft diameter that might exist at the top of a rock socket. A common practice is to use temporary casing to the top of rock, followed by a change in the tooling and a decrease in the diameter of the rock socket relative to the diameter of the shaft above the socket. Top-down compression loading produces perimeter bearing stress at the diameter change as illustrated in Figure 17-2319a, while loading from an O-cell at the bottom of the socket (Figure 17-19b) would lift the shaft from the bearing surface. The effect could occur where rock is fractured near the top of the formation due to weathering or other effects.

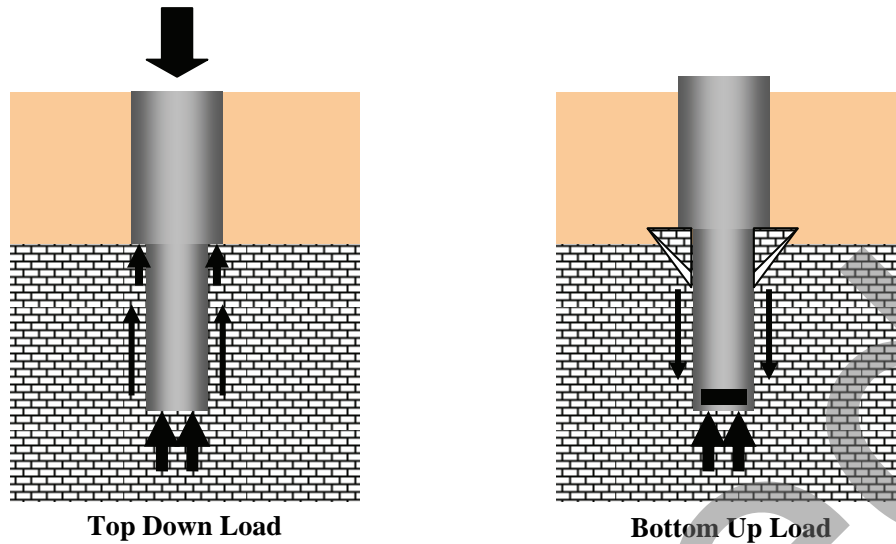


Figure 17-19 Effect of “Shoulder” at Top of Rock: a) Top-Down Loading; b) Bottom-Up Loading

Although full scale comparative test data are not available for drilled shafts in rock, some researchers (McVay et al, 1994; O’Neill et al., 1997; Shi, 2003) have pointed out differences between O-cell test conditions and top loading conditions in rock that may require interpretation. The most significant difference is that compression loading at the head of a shaft causes compression in the concrete, outward radial strain (Poisson's effect), and a load transfer distribution in which axial load in the shaft decreases with depth as shown in Figure 17-20. Dilatancy at the shaft/rock interface adds to the effect, with the result that the normal stress at the shaft/rock interface may be less in the O-cell test than in a top-down load test. Loading from an embedded O-cell also produces compression in the concrete but a load transfer distribution in which axial load in the shaft decreases upward from a maximum at the O-cell to zero at the head of the shaft. It is possible that different load transfer distributions could result in different distributions of side resistance with depth and, depending upon subsurface conditions, different total side resistance of a rock socket. Varying load transfer distribution with direction of loading computed using a finite element model are illustrated in Figure 17-21.

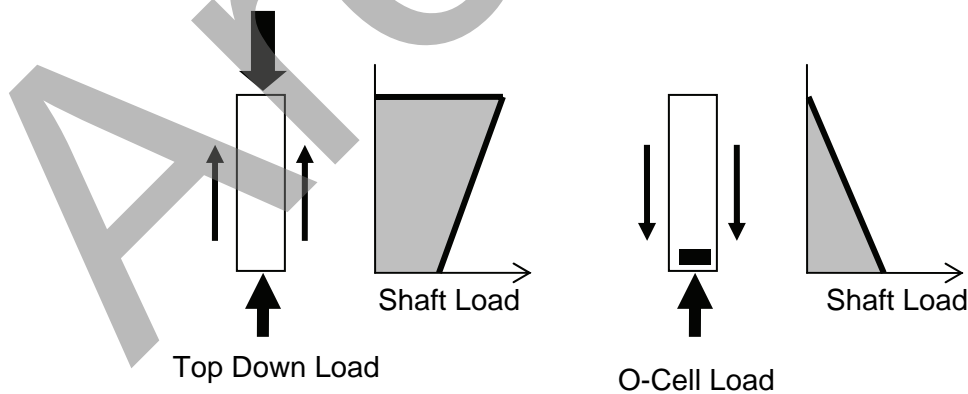


Figure 17-20 Average Compressive Load in Shaft During Top Down and O-Cell Loading



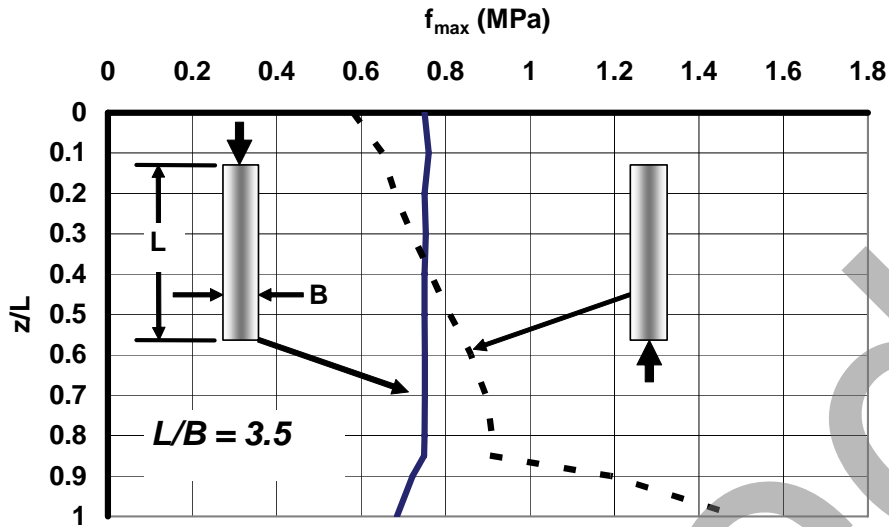


Figure 17-21 Analytical Model Results for O-Cell Loading in a Rock Socket (McVay et al, 1994)

Finite element modeling (FEM) reported by Shi (2003) suggests that differences in rock end bearing response between O-cell testing and top-load testing were not significant, and that differences in rock side shear response may be affected by (1) modulus of the rock mass,  $E_M$ , and (2) interface friction angle. Shi first calibrated the FEM model to provide good agreement with the results of O-cell tests on full-scale rock socketed shafts, including a test shaft socketed into shale in Wilsonville, AL, and a test shaft in claystone in Denver, CO, described by Abu-Hejleh et al. (2003). In the FEM model, load was applied similarly to the field O-cell test, i.e., loading from the bottom upward. The model was then used to predict behavior of the test shafts under a compression load applied at the top and compared to the equivalent top-load settlement curve determined from O-cell test results. Figure 17-22 shows a comparison of the top-load versus displacement curves for the Alabama test, one as calculated from the O-cell test and the other as predicted by FEM analysis using material properties back-fitted to the O-cell test. The curves show good agreement at small displacement, but the curve derived from FEM analysis is stiffer at higher displacement.

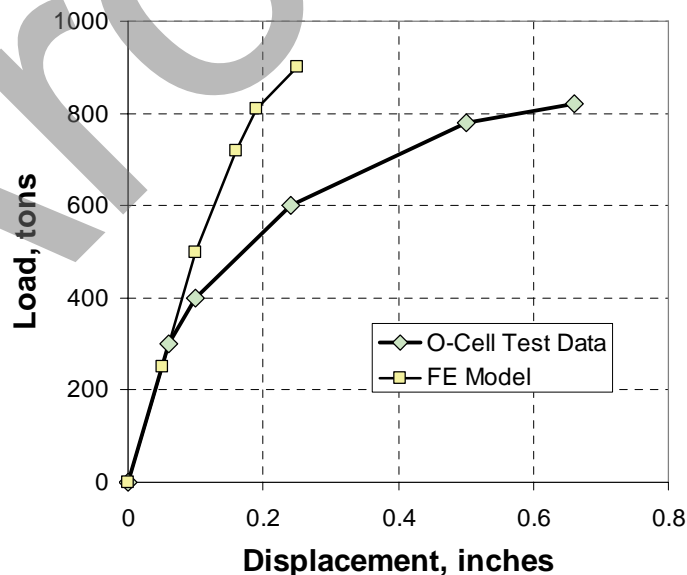


Figure 17-22 Analytical Model Results for O-cell Loading in a Rock Socket (Shi, 2003)

These analytical models suggest that the equivalent top-load settlement curve derived from an O-cell load test may underpredict side resistance compared to the case where end bearing resistance is simultaneously engaged and for higher displacements, *i.e.*, the O-cell derived curve is conservative. The differences between loading from the bottom (O-cell) and loading in compression from the top are due to differing normal stress conditions at the shaft/rock interface, and these differences become more significant with increasing rock mass modulus and increasing interface friction angle. These numerical analyses suggest that differences in the response of rock sockets to O-cell loading and top-down compression loading may warrant consideration in some cases.

Based on the available information, the following general guidelines are suggested for interpretation of O-Cell load tests:

- The measured axial resistance in end bearing and side shear for shafts in soils is equal to top down loading.
- The measured load transfer in end bearing for shafts in rock is similar to top down loading.
- The measured load transfer in side shear for shafts in rock, on average, may be conservative with respect to top down loading.
- The distribution of load transfer in side shear for shafts in rock may be biased toward higher unit values in the lower portion of the socket relative to the upper portion. Caution should be exercised with respect to extrapolation of the measured side shear resistance in the lowermost portion of the rock socket (presumably based on strain gauge data) to sockets of greater length. Unusually high unit side shear values in the lowermost portion of the socket may be an artifact of the bottom-up loading, and average values may be more representative of shaft performance.
- Construction of the equivalent top load-settlement curve should include an adjustment for the elastic compression of the drilled shaft.
- For design purposes, a careful interpretation of the results of a bi-directional (O-cell) load test should provide a measurement which is considered equivalent to a static load test. Therefore the resistance factors appropriate for design based on static load test results should apply.

Interpretation of O-cell load test data and unit values of axial resistance most often is based on strain gauge instrumentation. Additional information on strain measurements and instrumentation is provided in Section 17.2.3.

#### **17.2.2.2.3 Advantages and Limitations of Bi-Directional Load Testing**

Some of the advantages of the O-cell for axial load testing of drilled shafts include:

- The test provides the ability to apply larger loads than any of the available methods. This feature is especially important for rock sockets.
- The large capacity allows testing of production-size shafts in most cases.
- With multiple cells or proper instrumentation, the base and side resistances are isolated from the resistance of other geomaterial layers.
- The loading is static and can be maintained to observe creep behavior.

Limitations of the O-cell test include:

- The shaft to be tested must be pre-determined so that cells can be included; it is not possible to test an existing shaft in which an O-cell has not been pre-installed.

- For each installed device, the test is limited to failure of one part of the shaft only unless multi-level cells are used.
- The performance of a production shaft subject to top down loading must be computed and may require extrapolation of data in some cases.
- Limitations exist related to using a test shaft as a production shaft.
- The effect of upward directed loading compared to top down loading in a rock socket is not completely understood. Current procedures for estimating side resistance in rock sockets are likely to be conservative.

The bi-directional O-cell test provides transportation agencies with a practical and cost-effective tool for evaluating the performance of drilled shafts and it is expected that the O-cell test will continue to be used extensively. In many cases, it is the only practical method for field measurement of performance due to the magnitude of the loads imposed.

### 17.2.2.3 Rapid Load Test

Rapid loading utilized for testing of drilled shafts and other deep foundation elements employs a load which is so rapid that inertial and damping effects are important, but of sufficient duration that wave propagation effects are minimal. The test shaft is thus subjected to a fast “push” rather than a sharp blow as might be observed from a pile driving hammer. A relative comparison of the load applied to the shaft versus time is illustrated on Figure 17-23. With a rapid loading, the load is applied for a sufficient time interval that the shaft is pushed downward with the top and base of shaft moving together in a nearly rigid body motion. A hammer impact typically induces a short duration compressive stress wave which propagates down the shaft from the top to the base and returns as a reflected wave. The latter is referred to as a high strain dynamic loading and is described in Section, 17.2.2.4. The blow of a high strain dynamic test typically involves deceleration of a mass (the ram) which has a weight equal to about 1% of the test load. The load pulse of a rapid load test typically involves a mass which has a weight equal to about 5% to 10% of the test load. ASTM standard ASTM D-7383-08 has recently been adopted for rapid load testing.

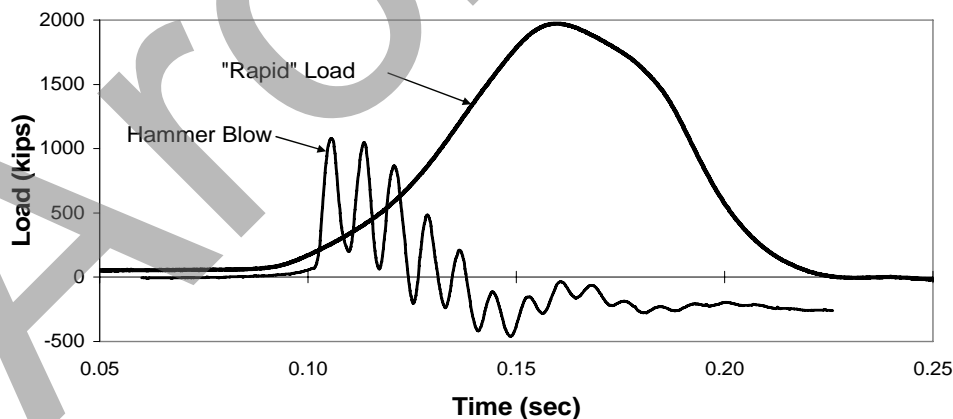


Figure 17-23 Comparison of Rapid Load and Hammer Blow

There are two methods of initiating a rapid loading on the top of a drilled shaft for purposes of testing, both of which are described in ASTM D-7383-08. One method is to drop a heavy mass onto the top of the shaft but to use such a soft cushion between the mass and the shaft that the deceleration of the mass occurs over the desired time interval. Such a cushion could consist of springs with an appropriate stiffness. Although the

dropped mass method has been reportedly used to generate forces of up to 500 tons on drilled shafts, the more common method is to position a heavy mass onto the top of the shaft and accelerate the mass upward using combustion gas pressure.

The test using combustion gas pressure is Newton's 2<sup>nd</sup> Law in action, Force = mass x acceleration. When the reaction mass is accelerated upward with 20g's of thrust, an equal and opposite downward force of 20 x the weight of the mass is applied, as illustrated on Figure 17-24.

The Statnamic® (STN) loading device uses combustion gas pressure to produce this type of loading and was developed in the late 1980's and early 1990's by Berminghammer Foundation Equipment of Hamilton, Ontario (Bermingham and Janes, 1989). Its use in the U.S. transportation industry has been supported by FHWA through sponsorship of load testing programs as well as tests conducted with a STN device owned by FHWA for research purposes. The STN is a patented test and, at the present time (2010) Applied Foundation Testing, Inc. (AFT) is the exclusive STN representative in the U.S.

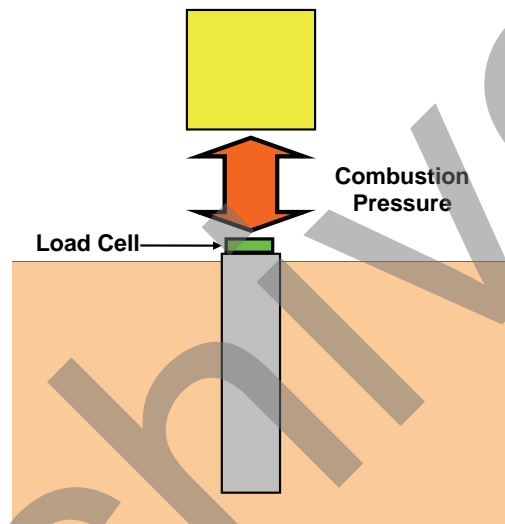


Figure 17-24 Conceptual Sketch of the Statnamic Rapid Load Test

The Statnamic loading system provides a means to apply loads of up to 5,000 tons to the top of the shaft without the requirement for an independent reaction system. The loading is achieved by using one of the devices illustrated in Figure 17-25. Combustion occurs in a central chamber and “launches” the reaction masses upwards for a distance of about 8 to 10 ft. The 500 and 2,000 ton systems employ a “catch” frame mechanism to contain the reaction masses in the center of the device. The 5,000 ton capacity device employs a gravel containment system whereby the gravel flows under the reaction masses (seen rising from the center) and “catches” them after the launch is completed. The smaller devices are more mobile, easier to set up and use, and thus provide a relatively low cost loading system which can even perform multiple tests in a single day. The 5,000 ton device represents the upper limit of the load capacity of this system at present (2010).

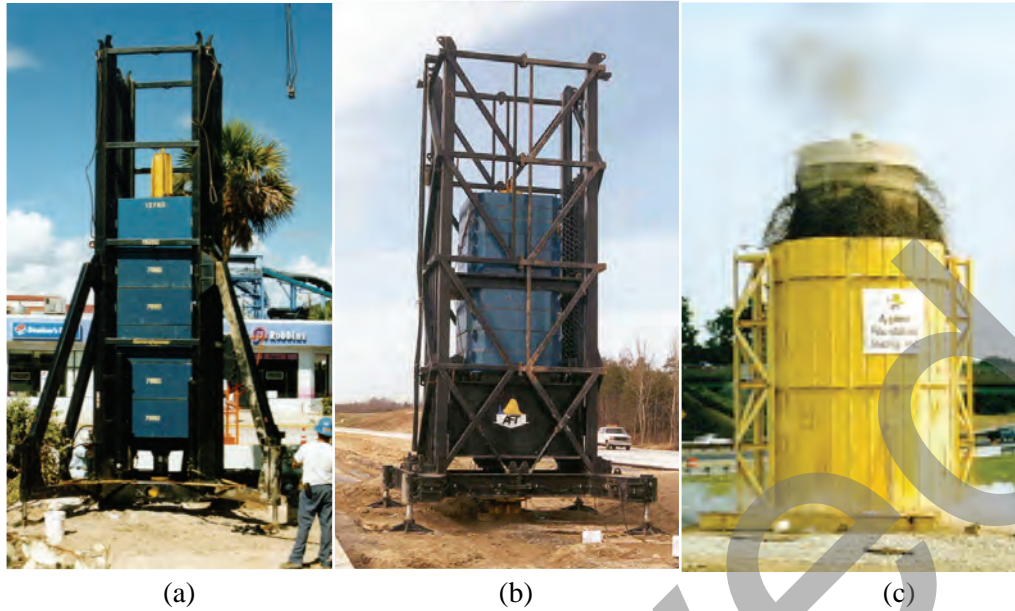


Figure 17-25 Statnamic Loading Devices; (a) 500 Ton Capacity; (b) 2000 Ton Capacity; (c) 5000 Ton Capacity

The remainder of this section will present an overview of rapid load testing as implemented with the Statnamic device, which is currently the more common application of rapid load testing for drilled shaft foundations in North America.

#### 17.2.2.3.1 Loading Apparatus and Procedure

The loading apparatus for the Statnamic test is illustrated schematically in Figure 17-26, with some photos of various components shown in Figure 17-27. The upward acceleration of the reaction mass is achieved using combustion of pelletized fuel (similar to the material used in automobile air bags) to generate gas pressure within a piston. The downward force is directed through a calibrated load cell which provides measurements of the applied force as a function of time. Direct measurements of displacement are obtained using a photovoltaic sensor (laser target) which is mounted with the load cell atop the shaft. The laser must be positioned at a sufficient distance from the test shaft (usually at least 50 ft) so that any vibration from load test activity does not arrive at the laser mount until after the test is complete. Servo-accelerometers are also mounted on the shaft to provide direct measurement of the downward acceleration of the test shaft and, via integration of these measurements, a backup measurement of displacement.

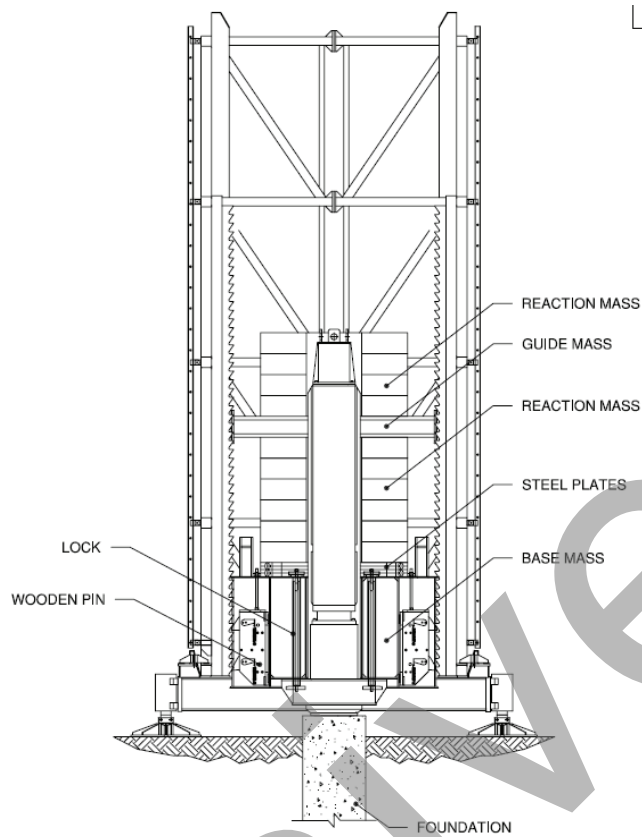


Figure 17-26 Schematic Diagram of Statnamic Loading Apparatus

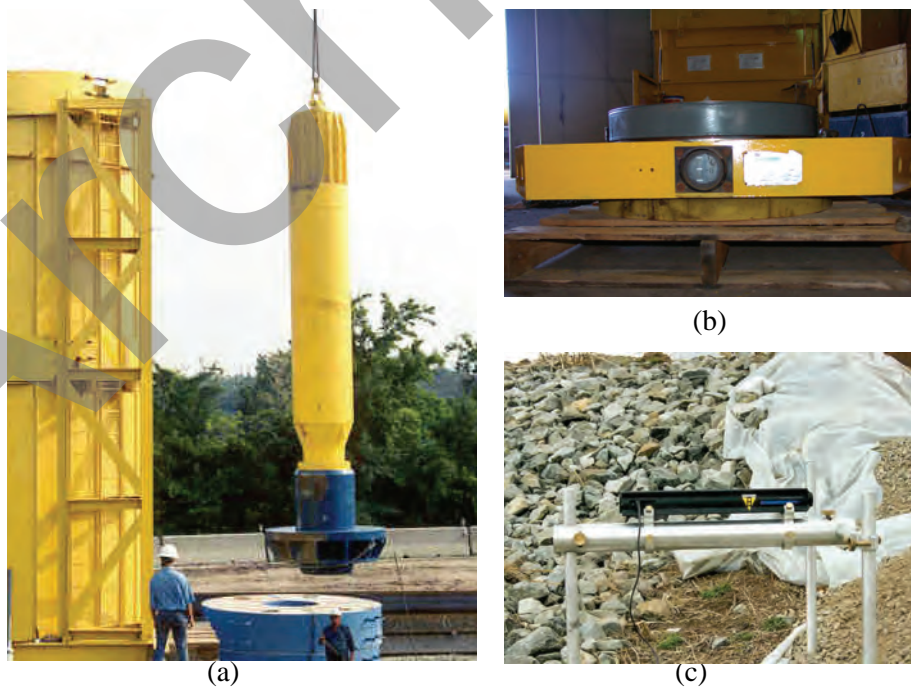


Figure 17-27 Statnamic Loading Apparatus: (a) Piston and Silencer Assembly; (b) Load Cell and Laser Target; (c) Laser for Displacement Measurement

Example measurements of load, displacement, and acceleration are illustrated on Figure 17-28. The measured acceleration times the weight of the shaft represents an inertial force which acts counter to the applied force measured via the load cell; the actual force resisted by the soil is the difference between these two forces. The downward movement of the shaft occurs as this force pushes the shaft into the soil. The test shaft illustrated in Figure 17-28 shows a small rebound at the end of the loading period, and most of the 2+ inches of movement is permanent displacement.

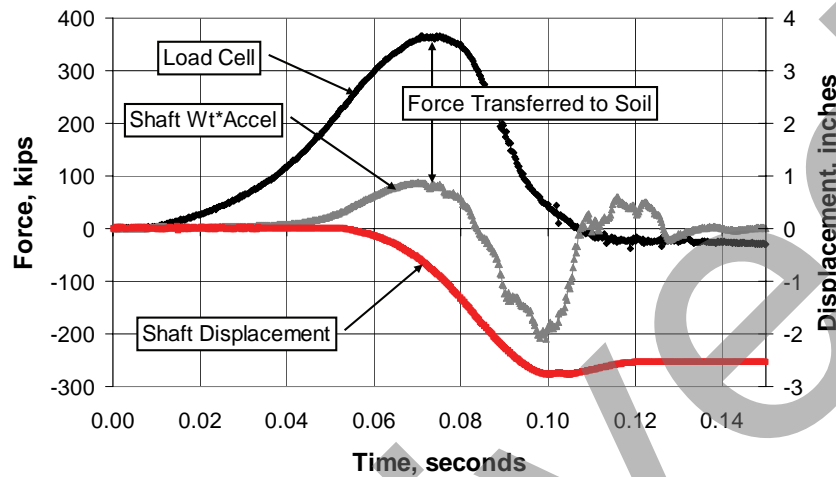


Figure 17-28 Measurements of Force and Displacement During Statnamic Loading

The behavior of the test shaft is illustrated by the load cell and load interpreted from strain measurements on a drilled shaft shown in

Figure 17-29. The shaft was socketed into limestone between elevation +26 ft and the base of the shaft at elevation +16 ft. The load cell was at the top of the 40-ft long shaft at elevation +56 ft. The strain data indicate that the behavior of the shaft during loading was similar to that of a rigid body. The travel time for a compression wave in a 40-ft long concrete member is approximately 0.003 seconds. This delay in the arrival of the peak force at elevation +19 ft relative to the load cell is small compared to the duration of the load pulse.

The following section describes the interpretation of the measurements to obtain static axial resistance. Instrumentation is described in Section 17.2.3.

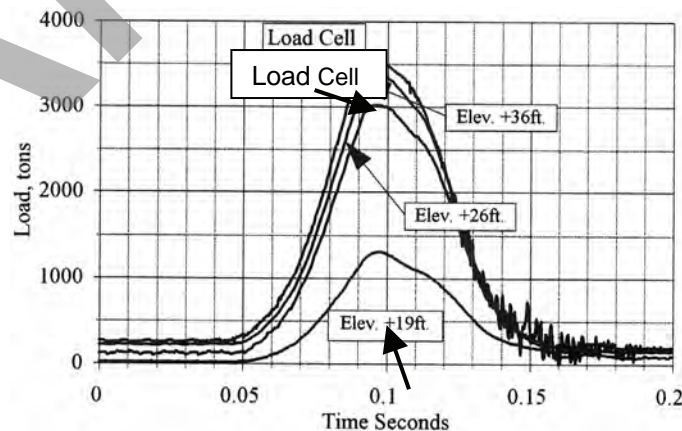


Figure 17-29 Force-Time Measurements for a Drilled Shaft

### 17.2.2.3.2 Derivation of Static Axial Resistance

The “unloading point method” (UPM) represents a simple method of analysis of the results of a Statnamic loading test which can be used in many cases. The UPM also provides the basis for more complex analyses described subsequently. Because of the duration of loading, all elements of the pile move in the same direction and with almost the same velocity; the UPM, therefore, is a simple approach which treats the shaft as a rigid body undergoing translation. Analytical studies by Brown (1994) have shown that this rigid body assumption is not appropriate for “long” shafts (generally more than about 80 to 100 ft in length). Subsequently, a more rigorous method of analysis called the “segmental unloading point method” (SUPM) has been developed by Mullins et al (2002).

The forces acting on the shaft during a Statnamic test include the applied load,  $F_{stn}$ , the shaft inertia force,  $F_a$ , and the soil resistance forces. The Statnamic applied force,  $F_{stn}$ , is measured. The shaft inertia force,  $F_a$ , is equal to the mass of the shaft times the acceleration of the shaft, and the acceleration is measured. Because of the rapid loading rate, the soil resistance forces include both the static soil resistance,  $F_u$ , and the dynamic soil resistance,  $F_v$ . The dynamic resistance includes any forces which might be rate-dependent and not mobilized during a conventional static load test, such as resistance from transient pore water pressures and other dynamic components of resistance. This component of force is modeled as a viscous damper, with a force that is proportional to the velocity. A simple single degree of freedom model of the problem is illustrated in Figure 17-30.

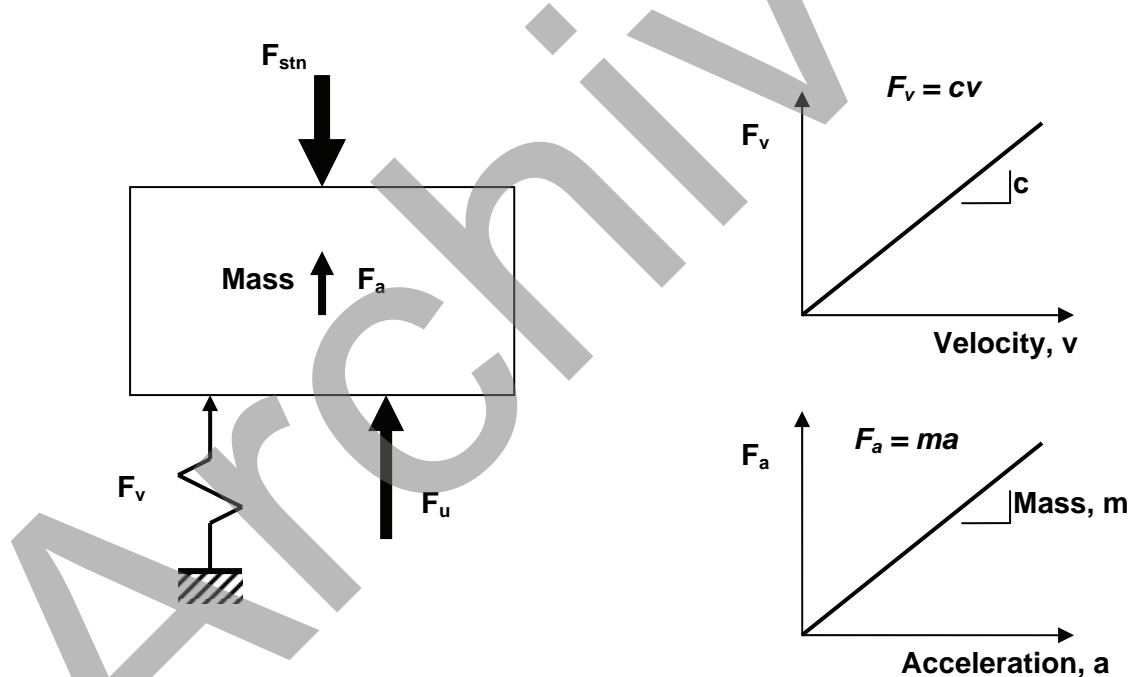


Figure 17-30 Single Degree of Freedom Model of a Statnamic Test

In mathematical terms, the force equilibrium on the pile may be described as follows:

$$F_{stn}(t) = F_a(t) + F_u(t) + F_v(t) \quad 17-3$$

This equation may be rewritten in terms of static soil resistance as follows:



$$F_u(t) = F_{stn}(t) - F_a(t) - F_v(t) \quad 17-4$$

Because the dynamic resistance in the model is proportional to velocity, this force is zero at the point where the shaft velocity is zero. The point of zero velocity is referred to as the “unloading point”, and is indicated as point 2 on Figure 17-31. At the unloading point, Equation 17-4 can be solved for  $F_u$  because  $F_{stn}$  and  $F_a$  are known.

The UPM derives the static resistance over the remainder of the curve as follows. The maximum static resistance is assumed to be mobilized and constant over the portion of the curve between the peak Statnamic force (point 1 in Figure 17-31) and the unloading point. This portion of the curve is then used to compute the damping coefficient,  $c$ , as indicated in Equation 17-5.

$$c(t) = \frac{F_{stn}(t) - F_a(t) - F_{u\max}}{v(t)} \quad 17-5$$

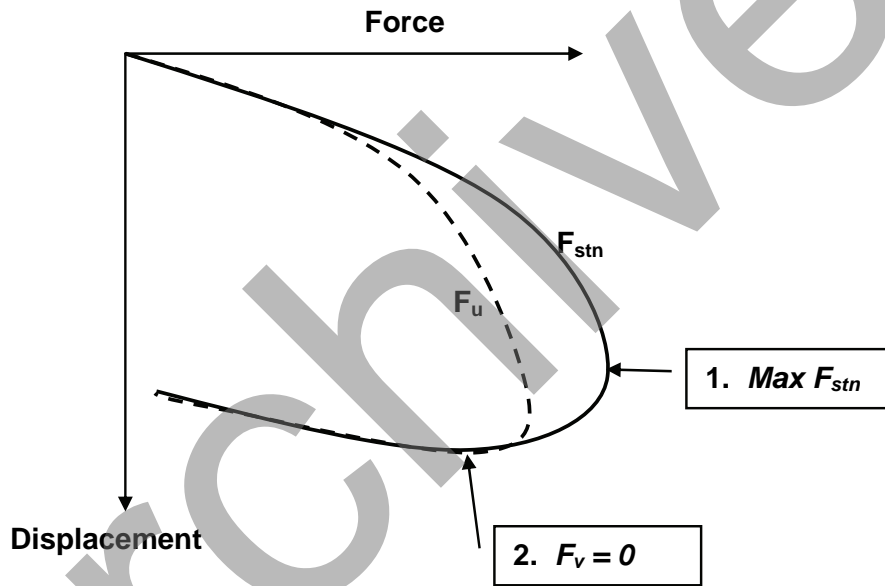


Figure 17-31 Statnamic Load versus Displacement

The damping coefficient,  $c$ , is directly computed at each measurement point between points 1 and 2, a best estimate average value is chosen as illustrated in Figure 17-32. This constant is then used to derive the remainder of the static load versus displacement curve using Equation 17-4 and illustrated on Figure 17-31. A slight modification of the above procedure may be made by using the computed or measured average acceleration of the shaft instead of assuming a rigid body motion.

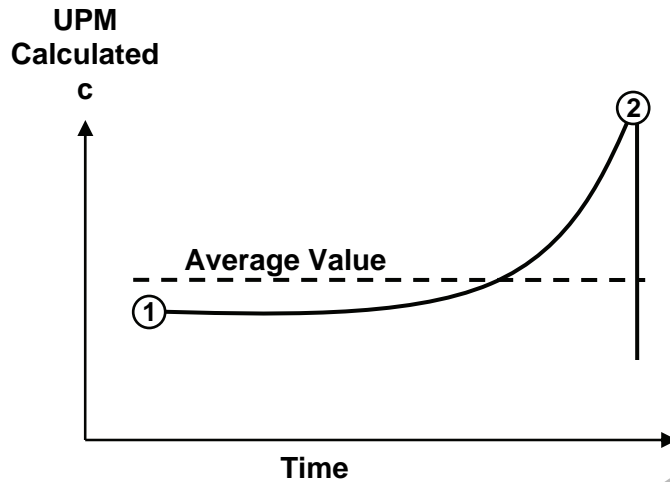


Figure 17-32 Computed Damping Coefficient,  $c$

For long shafts, the “segmental unloading point method” (SUP) is used. This method is based on the UPM described above, but treats the shaft as a series of segments as illustrated in Figure 17-33. Instrumentation within the shaft is typically used to determine the forces transferred between segments during the Statnamic test.

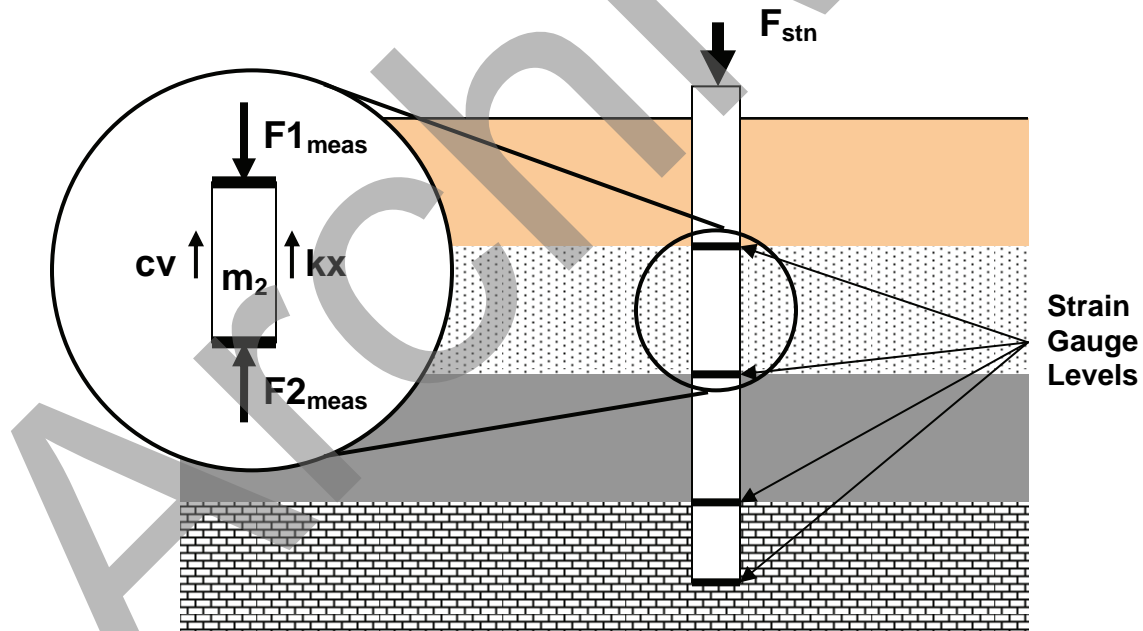


Figure 17-33 Segmental Unloading Point Method

Although the static resistance derived from the Statnamic load test as described above has accounted for dynamic effects during the test, there remains a rate-of-loading effect in the static resistance because the duration of the test is short compared to conventional static loading. Therefore, an empirical rate effect parameter is applied to the derived static resistance based on comparative tests described by Mullins (2002) by multiplying the static resistance by the factors shown in Table 17-4.

**TABLE 17-4 RATE FACTORS FOR DIFFERENT SOIL TYPES**

ROCK	SAND	SILT	CLAY
0.96	0.91	0.69	0.65

Comparative data between Statnamic load tests and static load tests on drilled shafts in Florida are reported by McVay et al (2003) and illustrated in Figure 17-34. For design of drilled shafts calibrated to site-specific Statnamic load test data, Florida DOT guidelines recommended a resistance factor of 0.70 for shafts with redundancy and 0.60 for non-redundant drilled shafts (compared to 0.75 and 0.65 for static load tests). Note that AASHTO Section 10.5.5.2.4 provides for a maximum resistance factor of 0.70 for drilled shafts calibrated to site-specific static load tests, with a 20% reduction in resistance factor for a non-redundant shaft foundation such as a single shaft supporting a single column.

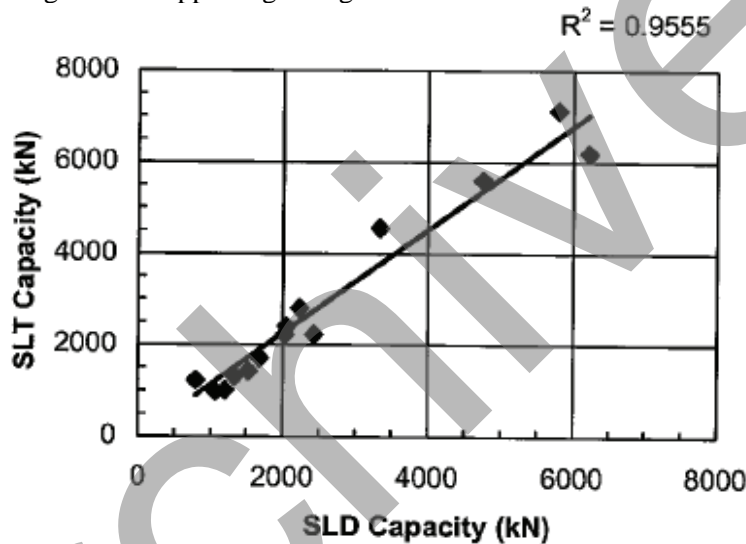


Figure 17-34 Comparative Static (SLT) and Statnamic (SLD) Load Tests for Drilled Shafts (from McVay et al, 2003)

Considering that some additional variability is introduced by performing a rapid load test compared to a conventional static load test, it is recommended that general design of drilled shaft foundations calibrated to site-specific Statnamic load test data should utilize a resistance factor which is 0.05 less than the factors outlined in AASHTO Section 10.5.5.2.4 for design based on static load tests. Therefore, a maximum resistance factor of 0.65 is indicated for design of drilled shafts calibrated to site-specific rapid load tests, with lesser values for non-calibrated Statnamic load tests, non-redundant foundations or unusually high site variability.

### 17.2.2.3.3 Advantages and Limitations of Rapid Load Testing

Most of the advantages and limitations of rapid load testing using the Statnamic device are apparent from the previous discussion. Loads of up to 5,000 tons can be applied to the top of a drilled shaft foundation without

the need for a reaction system or without special preparations during construction. These capabilities generally make this a cost effective tool which is useful for proof tests on production foundations or for performing multiple load tests at a site. The device is particularly useful for verification of production shafts when questions arise regarding geotechnical resistance. However, the capacity limitations of the test device may still be an impediment to the use for large scale tests of high capacity drilled shafts compared to the capacity of the bi-directional test. Rate effects must also be considered. Some of the advantages and limitations are summarized below.

Advantages of rapid load testing include:

- Large test load, applied at top of shaft
- Can test existing or production shaft
- Economies of scale for multiple tests
- Amenable to verification testing on production shafts
- Reaction system not needed

Limitations of rapid load testing include the following:

- Maximum test load is high, but still limited compared to bi-directional tests
- Rapid loading method; rate effects must be considered
- Mobilization costs for reaction weights

#### **17.2.2.4 High Strain Dynamic Load Test**

High strain dynamic load testing is a relatively mature technology which has been used for many years with driven pile foundations; the blow of a pile driving hammer on the top of the pile provides the loading for a dynamic load test, if suitable measurements are obtained so that the applied load and pile response can be determined. The measurements are obtained using transducers mounted directly on the pile, and a computer model of the pile response to the blow is calibrated to the measurements using a signal matching technique (e.g., "CAPWAP"). The same technology can be applied to drilled shaft foundations with some considerations for the different nature of a drilled foundation. A description of the application of high strain dynamic tests on drilled shafts is provided by Robinsons et al (2002).

##### **17.2.2.4.1 Loading Apparatus and Procedure**

The procedure for testing deep foundation elements using high strain dynamic load testing is described by ASTM Standard D 4945-00. The high strain dynamic load is imposed by the impact of a falling mass which typically has a weight around 1% to 2% of the desired test load. The impact can be accomplished by either a specially fabricated drop weight test apparatus as shown at left in Figure 17-35, or a large pile driving hammer as shown at right. The hammer shown was used to mobilize axial resistance of approximately 4,000 tons on a 6-ft diameter drilled shaft supporting the column shown in the photo.



Figure 17-35 Dynamic Load Test of Drilled Shafts using Drop Weight (left) and Pile Hammer (right). [Photos courtesy of Pile Dynamics, Inc. (left) and Ross McGillivray (right)]

The high strain dynamic load test setup should always be modeled prior to the test using a wave equation model for specific shaft size and anticipated axial resistance (Hussein et al, 1996). Because the high impact velocity can potentially produce significant compression and tension forces in the shaft, the blow must generally be cushioned using a cushioning material such as plywood. Increasing the drop weight from 1 to 2% of the test load to a value closer to 5% of the test load and using a softer cushion provides another strategy to limit stress in the shaft; this approach results in an impulse of similar duration to the rapid load test described in Section 17.2.2.3.

Measurements of force and velocity at the top of the shaft are needed to perform the analyses necessary for dynamic load testing. These measurements are typically obtained using a Pile Driving Analyzer<sup>®</sup> (PDA) or similar device. The measurement of force,  $F_e$  is obtained from the strain transducer as:

$$F_e = \varepsilon EA \quad 17-6$$

where:  $\varepsilon$  = measured strain  
 E = elastic modulus of the shaft  
 A = cross sectional area of the shaft

The measurement of force is also obtained from the acceleration measurement. The acceleration is integrated to obtain particle velocity, and the force proportional to velocity,  $F_v$  is obtained by:

$$F_v = \frac{vEA}{c} \quad 17-7$$

where: v = measured particle velocity  
 E = elastic modulus of the shaft  
 A = cross sectional area of the shaft  
 c = compression wave speed in the shaft

The determination of the forces applied to the shaft is therefore a function of the elastic modulus, cross sectional area, and compression wave speed of the shaft. The force measurements derived from the two separate types of measurements should be proportional if good measurements are obtained. The measurements from transducers on opposite sides of the shaft should be very similar if the impact is centered and square to the top of the shaft. In cases where the top of the shaft is inaccessible, measurements of force can be made using an extension to the top of the shaft composed of a very heavy wall pipe section which is instrumented and calibrated to measure force. The drop weight can also be instrumented with an accelerometer, and the deceleration of the mass used to measure the force applied to the top of the shaft ( $F=ma$ ). However, in order to perform signal matching analyses using the measured response of the drilled shaft itself, it is desirable to obtain measurements directly on the drilled shaft.

In order to obtain measurements of force and velocity at the top of the shaft, it is necessary that the top of the shaft be exposed so that strain gauges and accelerometers can be mounted onto the concrete or casing as illustrated in Figure 17-36. In order to obtain reliable measurements of shaft response, these gauges should be mounted at four points 90° apart around the sides of the shaft. Although the ASTM standard requires that the gauges be mounted at least 1.5 shaft diameters below the top of the shaft, one diameter below the top may be sufficient for drilled shafts with four sets of transducers. The placement of gauges on opposite sides is intended to provide detection of an uneven blow and averaging out of small variations due to bending.

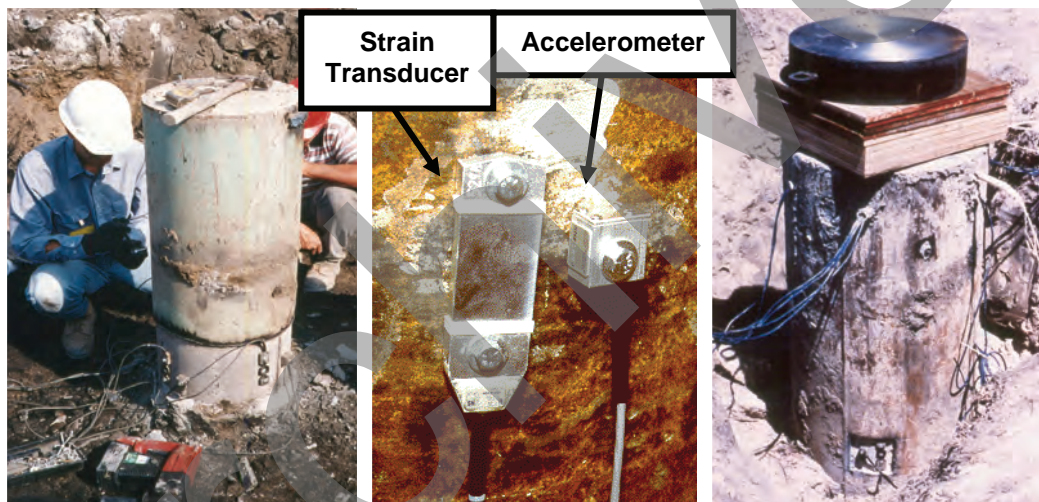


Figure 17-36 Transducers for Measurement of Force and Acceleration (Photos courtesy of Pile Dynamics, Inc.)

Note that the distance required to mount transducers below the shaft top could necessitate a significant excavation for shafts of large diameter. Because of this fact, and also because there is often reinforcement extending above the top of the shaft, one common practice is to cast a concrete segment above the top of shaft for the application of the impact blow. This separate “drive head” casting can be removed with jackhammers after completion of the dynamic testing. The use of a drive head casting has several benefits:

- It allows the transducers to be mounted on a segment of known and uniform cross section.
- Since it can easily be cast in the dry, the segment cast above grade should have concrete of high and uniform quality.
- The need for excavation is avoided.
- Any reinforcement extending above the top of the shaft can be incorporated into the drive head.

Gauges may sometimes be placed on the permanent casing near the top of the shaft. However, in order to obtain good measurements of the shaft performance, the casing and shaft must act as a composite section without slippage so that the measurements on the casing reflect the shaft response. A length of more than one shaft diameter may be necessary to develop the bond needed for composite action. In order to ensure that the measurements more accurately reflect the shaft response, it may be necessary to cut a window in the casing and mount gauges directly on the concrete, as illustrated on the photo at right in Figure 17-36.

The displacement as a function of time is obtained from double integration of acceleration, and the permanent set after several blows is checked using surveying instruments or by reference to a known datum.

Two to ten impact blows are typically obtained in order to mobilize the axial resistance of the shaft. The first blow is often not the most useful since there may be insufficient permanent displacement to mobilize the base resistance of the shaft.

#### **17.2.2.4.2 Derivation of Static Axial Resistance**

The fundamental concepts used to evaluate high strain dynamic testing involve the propagation of a compression wave in a one dimensional rod. This problem is the basic problem of a hammer blow on a driven pile foundation. The basics of wave mechanics, energy transfer, and analyses of pile capacity from dynamic load testing is described thoroughly in the FHWA Driven Pile Manual (Hannigan et al, 2006). This section provides an overview of the process and description of those issues specific to drilled shafts.

A device such as the PDA or similar system typically includes closed form algorithms for quickly computing axial resistance from the measurements of a blow. The FHWA Driven Pile Manual describes the “Case Method” with different variations of the equations used depending upon the nature and distribution of the soil resistance acting on the pile. However, a more rigorous method is recommended for analysis of dynamic load tests on a drilled shaft.

The derivation of axial static resistance from a high strain dynamic test is typically obtained using a computer analysis that involves signal matching as illustrated in Figure 17-37. The basic idea is that a model of the shaft with soil resistance is constructed and used to compute the response at the location of the transducers due to the propagation of the input force and velocity from the blow. The computed response is compared with the measurements, and the input parameters (distribution of soil resistance) are modified until the computed and measured responses are in agreement.

The computational model for performing the signal matching includes a numerical model of the shaft as a series of individual segments, each having mass and stiffness and each attached to a soil model as illustrated in Figure 17-38. The soil includes components of static and dynamic resistance, and the entire numerical model is used to perform a time-domain analysis of the propagation of the input force and velocity pulse from the blow. Reflected waves from each individual segment affect the computed response at the shaft head (location of transducers) and provide a basis for the signal matching process. FHWA-sponsored research led to the development of the computer code CAPWAP (CAse Pile Wave Analysis Program). This code is now available as a proprietary program from Pile Dynamics, Inc. and is the most widely used software product in North America, although other similar software products are also now available for this purpose.

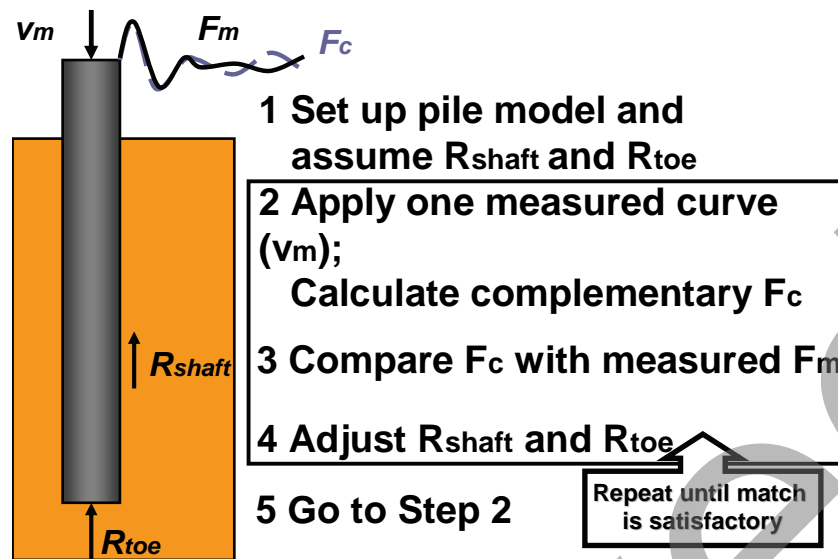


Figure 17-37 Signal Matching Concept

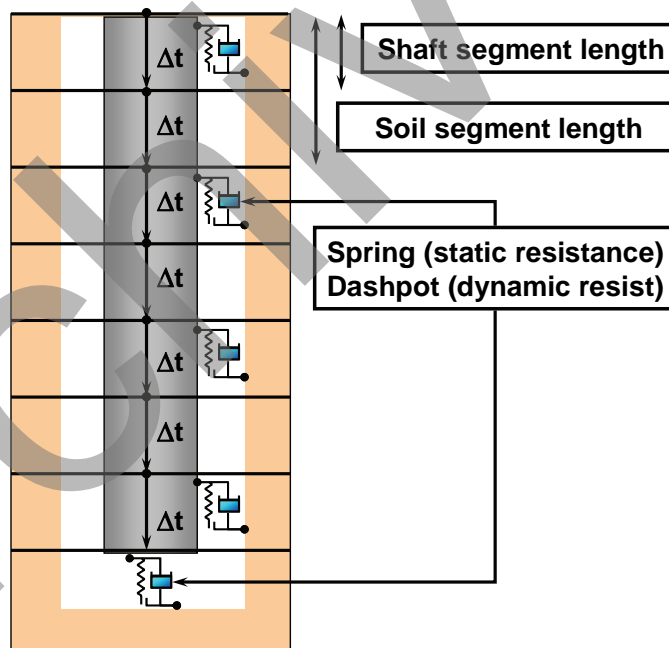


Figure 17-38 Computational Model of Shaft/Soil System

Once a good match of the computed and measured response is achieved, the distribution of side and base resistance in the model is considered as a good estimate of the behavior of the test shaft. While the solution obtained from the signal matching is not unique and should not be taken as a precise measurement of the distribution of resistance along the shaft, the computed response is sufficiently constrained that the model is considered to be a reasonably reliable indication of the approximate distribution of resistance. An example of the measured and computed forces at the top of a pile is illustrated on Figure 17-39, with the time scale marked in terms of  $L/C$ , length of pile divided by compression wave velocity. A reflection from the pile toe



would occur at a time equal to  $2L/C$ . This figure illustrates the influence of the various components of shaft and base (toe) resistance on the measured and computed forces at the top of the shaft.

The damping component of resistance is important, because the total soil resistance to penetration is the static resistance plus the damping resistance. The analysis is most sensitive to total resistance, and if damping were underestimated, then the static resistance might be overestimated (and vice versa). Therefore it is essential that the soil conditions be known from borings and drilled shaft logs so that the damping values determined from the analysis be checked for consistency with established guidelines.

An additional and very important factor which influences the reflections at the top of a drilled shaft is the variations in shaft impedance ( $EA/c$ ) along the length of the shaft. A change in cross sectional area or in modulus of the shaft as illustrated in Figure 17-40 will produce reflections at the shaft top. Since variations in shaft impedance complicate the analysis, it is important that the soil resistance and the physical profile of the shaft be both considered interactively during the signal matching exercise and compared with the known soil profile. One method for estimating the impedance profile of the shaft is to perform low-strain integrity testing with the sonic echo technique on the shaft, as illustrated on the photo at right in Figure 17-41. The sonic echo test is described in Chapter 20 of this manual.

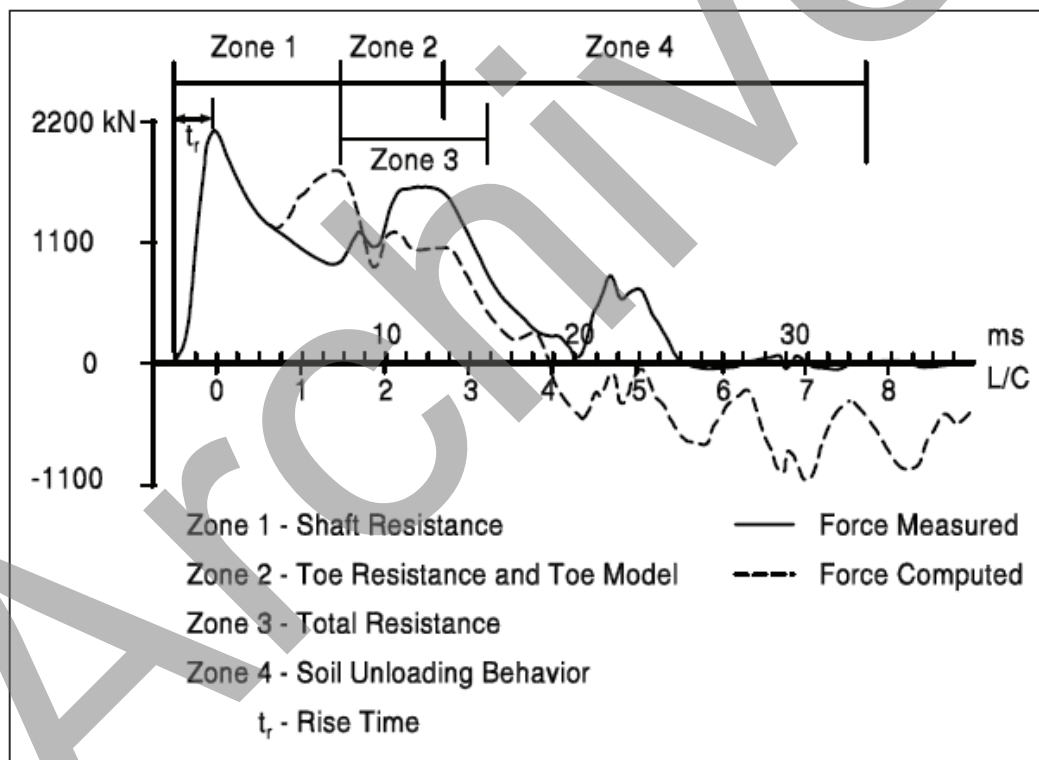


Figure 17-39 Factors Most Influencing CAPWAP Force Matching (after Hannigan, 1990)

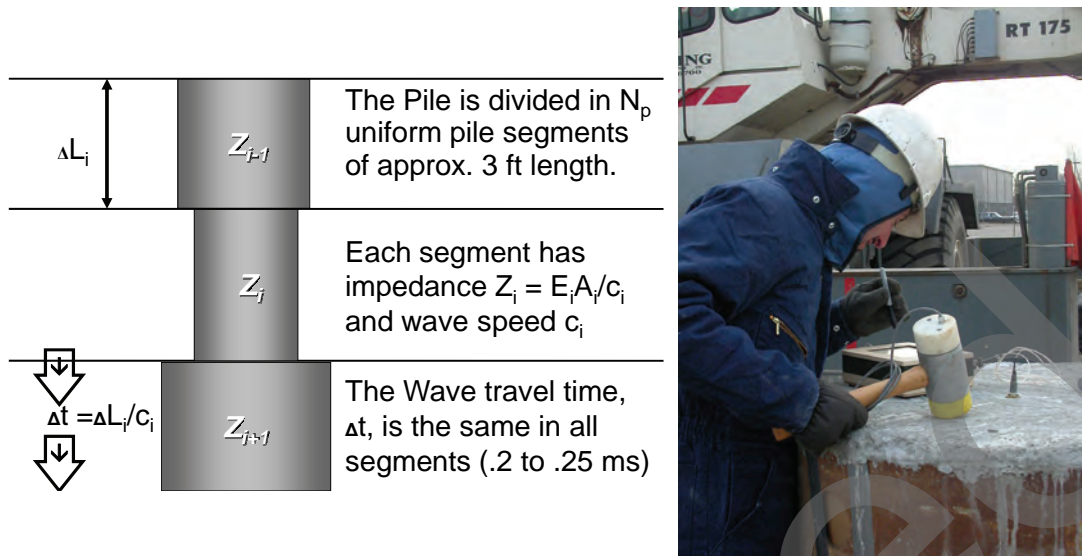


Figure 17-40 Impedance Profile of the Drilled Shaft

Another issue related to high strain dynamic testing of drilled shaft foundations is the relatively large displacement which may be required to mobilize the end bearing compared to the displacement achieved on a single blow. A good high strain dynamic measurement generally requires that the permanent set on a single blow should not exceed about 1/3 inch (e.g., 3 blows or more per inch); larger set tends to induce tension waves in the shaft which could be damaging and also affect the interpretation of the measurements. For a 4 to 7-ft diameter shaft, this magnitude of displacement only represents about 0.7% to 0.4% of the shaft diameter. To achieve a displacement in the 3% to 5% range for 4 to 7-ft diameter drilled shafts requires a movement in the range of 1.5 to 4 inches, and thus 5 to 12 blows would be required if the impact were achieving the upper limit of 1/3 inch per blow. Therefore, the first few blows may not provide a good indication of the base resistance of the shaft. After too many blows, the side shear may tend to be reduced because of the dynamic effects (the shaft is being driven like a pile), and therefore many blows on the shaft may not provide a good indication of the static resistance in side shear. The optimum blow to use as an indication of static resistance is often the one which provides the greatest magnitude of derived static resistance.

A discussion of this effect and other factors affecting the interpretation of dynamic load tests on drilled shafts and large diameter piles is presented by Rausche et al. (2008), who recommend performing CAPWAP analyses on several successive blows in order to interpret the results appropriately. The data presented in Figure 17-41 illustrate the CAPWAP computed static response (matched to dynamic measurements) of a 6-ft diameter by 65-ft long drilled shaft subjected to four successive blows. The four blows produced a total cumulative net displacement of just over 1/2 inch (about 14 mm). The first two blows only partially activated the end bearing while the second blow activated the maximum side shear. The third and fourth blows engaged progressively more end bearing, but the magnitude of the side shear (the difference between the top and the toe load) begins to diminish after the second blow.

Note that CAPWAP analyses of a dynamic test with insufficient force to mobilize the shaft capacity will only indicate a resistance equal to that mobilized during the test.

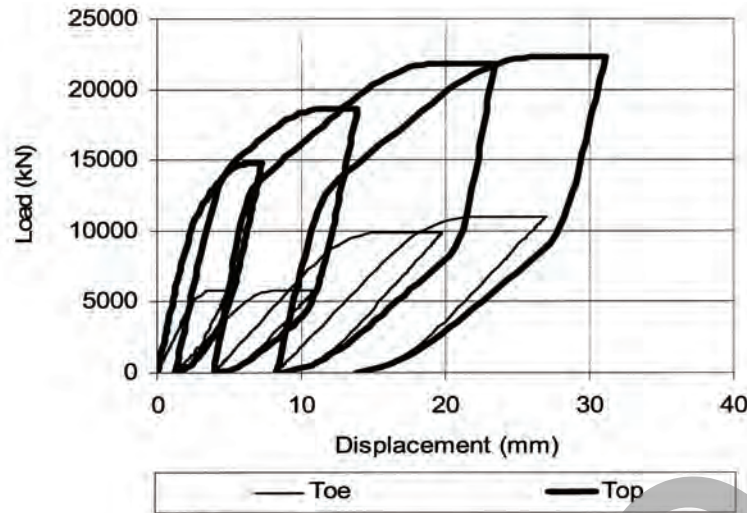


Figure 17-41 CAPWAP Calculated Load Cycles for Four Blows on a 6-ft Diameter Shaft; 1 kip = 4.45 kN; 1 inch = 25.4 mm (after Rausche et al, 2008)

The AASHTO code does not address design of drilled shafts based on high strain dynamic load tests, but provides for the use of a resistance factor of 0.65 for driven piles based on dynamic load tests. However, this approach is for piles which are to be driven to a consistent driving resistance with the same hammer used to perform the dynamic load test, and with at least one dynamic load test pile per pier. The consistency of the axial resistance of drilled foundations must be verified by other means during inspection of the installation process. Note that AASHTO Section 10.5.5.2.4 provides for a maximum resistance factor of 0.70 for drilled shafts calibrated to site-specific static load tests, with a 20% reduction in resistance factor for a non-redundant shaft foundation such as a single shaft supporting a single column.

Considering that some additional variability is introduced by performing a high strain dynamic load test compared to a conventional static load test, it is recommended that general design of drilled shaft foundations calibrated to site-specific high strain dynamic load test data should utilize a resistance factor which is 0.10 less than the factors outlined in AASHTO Section 10.5.5.2.4 for design based on static load tests. Therefore, a maximum resistance factor of 0.60 is indicated for design of drilled shafts calibrated to site-specific high strain dynamic load tests, with lesser values for non-calibrated high strain dynamic load tests, non-redundant foundations or unusually high site variability.

#### 17.2.2.4.3 Advantages and Limitations of High Strain Dynamic Load Testing

Most of the advantages and limitations of high strain dynamic load testing are apparent from the previous discussion. Loads of up to 4,000 tons (or potentially more with a very large drop hammer) can be applied to the top of a drilled shaft foundation without the need for a reaction system and with only modest preparations of the shaft top during construction. These capabilities make dynamic load testing a cost effective tool which is useful for proof tests on production foundations or for performing multiple load tests at a site. However, the capacity limitations are still an impediment to the use for large scale tests of high capacity drilled shafts compared to the capacity of the bi-directional test. Rate effects due to damping resistance represent an additional variable. Some of the advantages and limitations are summarized below.

Advantages of high strain dynamic load tests include:

- Large test load, applied at top of shaft
- Can test existing or production shaft
- Economies of scale for multiple tests
- Low cost compared to other forms of testing
- Amenable to verification testing on production shafts
- Reaction system not needed

Limitations of high strain dynamic load tests include the following:

- Capacity high, but still limited compared to bi-directional tests
- Test includes dynamic effects which must be considered by a signal matching analysis
- The interpretation of measurements on the shaft is affected by the shaft modulus, area, and uniformity in the top 1 to 1.5 diameters.
- Test must be designed to avoid potential damage to the shaft from driving stresses
- Mobilization costs for a large pile driving hammer or drop hammer
- The shaft shape must be considered in the analysis; the shape might be known from installation records, or derived from the signal matching process guided by the soil profile
- Multiple impacts may be required to fully mobilize the base resistance. If a loss of side resistance is observed after multiple blows, then this issue complicates the interpretation of the results

#### 17.2.2.5 Uplift Test

For projects where drilled shafts are to be subjected to substantial uplift loading (e.g., because of overturning moments applied to the structure through seismic events or extreme winds, or foundations at the anchorage end of permanent cantilevers), it is appropriate to perform uplift tests. An arrangement for the performance of a conventional uplift test of a drilled shaft is shown in Figure 17-42 (Sacre, 1977). The key feature of the arrangement is that some of the longitudinal rebars that are embedded full length in the test shaft, extend upward to a point well above the head of the test shaft. These extended rebars may be made of high-strength steel and are often equipped with a threaded connection. The reaction beams may be supported on compression shafts or even on surface mats if the ground conditions are favorable. Other than the position of the loading jack and reaction beams, the test is similar to a conventional compression test. Other types of uplift tests are possible (e.g., Johnston et al., 1980), and O-cell tests can be used to determine resistance to upward directed load.

A couple of special considerations are noteworthy with respect to uplift loading as compared to conventional compression loading: 1) the reaction system may need to be relatively far away in some cases to avoid affecting the results, and 2) the shaft may be in tension (load applied at top of shaft) or compression (load applied at shaft base) depending upon how the test is arranged.

In the case of a shaft anchored into rock which may contain fractures or seams, the zone of a possible “cone breakout” near the top of the rock formation may be of significant size. The reaction foundations must be located sufficiently far away from the uplift test shaft so that they do not influence the rock mass affecting the uplift capacity, as illustrated in Figure 17-43. This effect is particularly important for reaction foundations bearing on surface mats. The necessary lateral distance to reaction foundations may be influenced by the

embedded length of shaft, depth to rock, and other factors. In some cases it may be desirable to utilize reaction shafts to avoid surface stresses in the zone of influence of the test shaft.

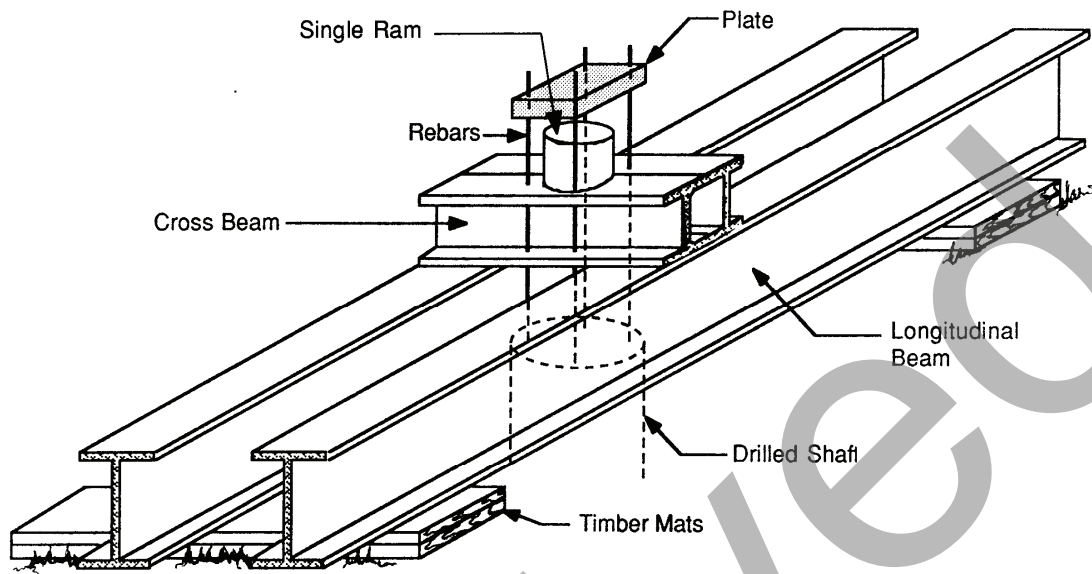


Figure 17-42 Arrangement for Testing a Drilled Shaft under Uplift Loading

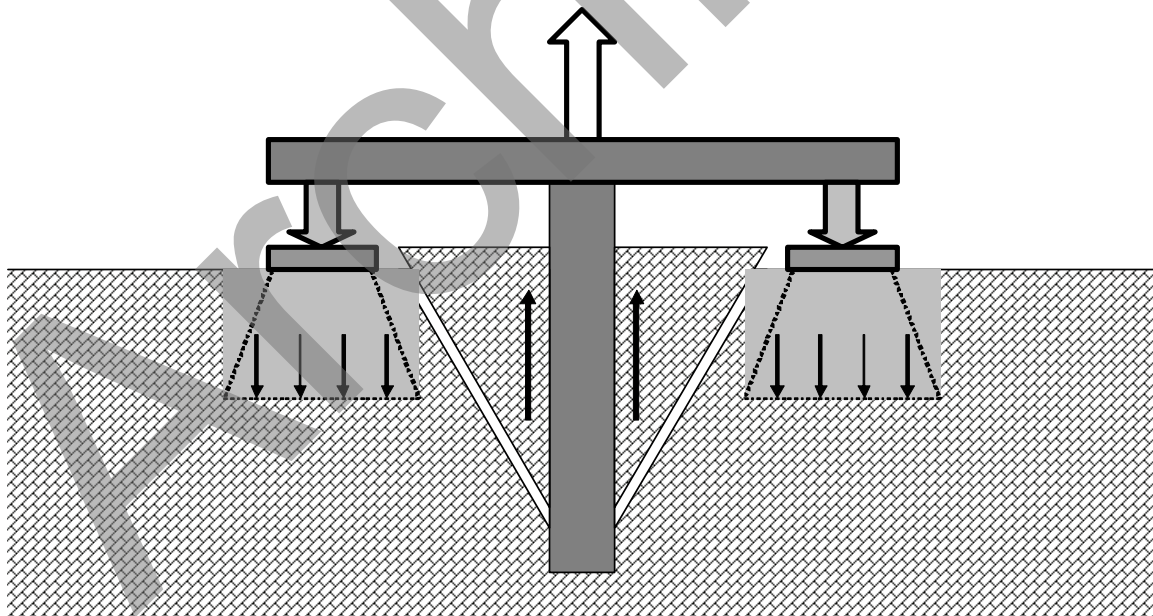


Figure 17-43 Location of Reaction Mats Relative to Uplift Shaft in Rock

A production drilled shaft which is loaded in uplift typically has the load applied to the shaft by pulling the reinforcement at the top of the shaft, thus placing the foundation into tension. With some types of anchorage

foundations, it is possible to sleeve the reinforcement through the length of the shaft to an anchorage plate at the base (or use an O-cell loading system at the base), thus placing the shaft into compression for an uplift load. The geotechnical response in side shear for each of these two conditions may be different, particularly for a shaft which is anchored into rock as illustrated in Figure 17-44. The Poisson's ratio effect due to elastic deformation of the shaft for the tension case will tend to reduce the lateral stress at the shaft/rock interface, whereas the opposite is the case for the shaft loaded in compression. The best approach to uplift loading is that the test should replicate the production condition, if possible.

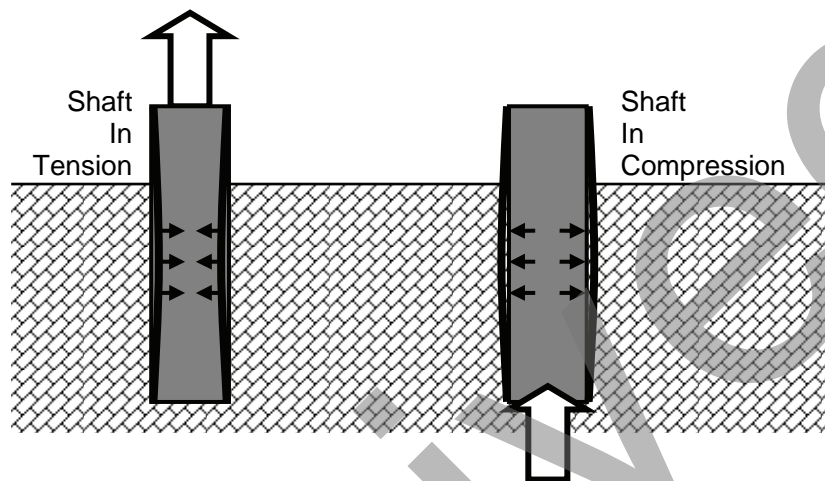


Figure 17-44 Uplift Shafts in Tension versus Compression

### 17.2.3 Instrumentation

Instrumentation is a critical part of the load test system to obtain measurements of drilled shaft performance during the test. The instrumentation system must be robust and reliable as well as accurate. In addition to the measurement of load and displacement at the top of the shaft, measurements of strain along the length of the shaft can provide important information about the distribution of load transfer in side shear and end bearing. This section provides an overview of the instrumentation used to measure loads and displacements on and within the test shaft.

#### 17.2.3.1 Application and Measurement of Load

Measurement of load is obtained using hydraulic pressure measurements on the jack and using electronic load cells. With top-down static tests, it is desirable to obtain both measurements to provide redundancy. In general, the use of a calibrated electronic load cell provides the more accurate measurement of load, as this device is not subject to stiction. Both can be subject to measurement errors due to misalignment and eccentricity in the loading system. The rapid load test should include a calibrated electronic load cell within the loading apparatus. The bi-directional embedded jack relies upon a calibration of the jack load to measured pressure. High strain dynamic tests do not have a direct measure of applied load except as inferred from strain and velocity (actually acceleration) measurements on the shaft.

In any instrumentation plan, it is desirable to provide redundancy in the measurement of load. Even if a load cell is used as the primary means of determination of load, measurement of jack pressure provides a backup system. If only jack pressure is measured, two separate and independent measurements of pressure should be included.

### 17.2.3.1.1 Hydraulic Jack

Hydraulic jacks are used to apply static load to the shaft via applied hydraulic pressure that is applied with a pump. The capacity of the jack is a function of the size of the ram and the magnitude of pressure which can be used in the jack and applied by the pump. Electric or hand-operated pumps may be used, depending on the size of the jack and volume of fluid required to operate the system. For large loads, multiple jacks may be used in parallel, as illustrated in the photo at right in Figure 17-45. The magnitude of travel in the jack is another potential consideration, particularly where large shaft displacements are anticipated. Note that the O-cells shown in Figure 17-17 are also simple hydraulic jacks which are designed to be embedded in the shaft.

The jack should be calibrated so that the applied pressure corresponds to a known load during the test. Pressure may be observed using an analog pressure gauge on the jack or with in-line pressure transducers which may be recorded with a data logger. The most reliable location for the pressure sensor is near the jack rather than at the pump to reflect losses in the lines between the sensor and the jack.

Besides the measurement of pressure, the major source of error in using a jack as an indicator of load is the stiction (static friction) in the jack itself, which may vary with rate of load and with the direction of movement (up or down) of the jack. If any significant misalignment is present in the loading system, the jack may be loaded eccentrically. Besides the obvious potential to damage the jack, eccentricity in the applied load affects the relation between the measured pressure and the load applied to the test shaft by the jack. The reaction beam must not be subject to twisting as the load is applied because any out-of-plane distortion produces eccentricity and misalignment in the loading system. A hemispherical bearing or swivel head system is typically used in the jack system to accommodate small angular differences between the reaction beam/plates and the end of the ram.



Figure 17-45 Hydraulic Jacks for Static Load Tests

### 17.2.3.1.2 Load Cell

A load cell is a passive element included within the loading system for the purpose of measurement of load. A typical load cell is illustrated on the left of Figure 17-45. This cell is an elastic steel element with strain gauges that have been calibrated to load. Another load cell was illustrated in Figure 17-28 as a part of the rapid load test (Statnamic) apparatus. In general, load cells are considered to provide a more reliable measure of load than a hydraulic jack because the passive cell is not subject to stiction as is the hydraulic ram. However, misalignment and eccentricity in applied load can still result in significant measurement errors, even with a load cell. The types of strain gauges used in load cells may vary and the requirements are dependent upon the rate of loading; strain gauges are described in Section 17.2.3.3.

### 17.2.3.2 Measurement of Shaft Displacement

Determination of shaft displacement at the shaft top or point of load application should also include redundant measurements.

#### 17.2.3.2.1 Shaft Top

The most widely used method of measuring shaft top displacement for conventional static load tests is to mount a series of dial gauges or displacement transducers onto a reference system. Displacement gauges should ideally be mounted at several points atop the test shaft so that an average value can be obtained. Analog dial gauges may be read and recorded manually, and other types of displacement transducers such as LVDT's (linear variable differential transformers) or linear potentiometers (essentially a variable resistor) may be monitored with an automated data logger. Sufficient accuracy of measurements (generally 0.01 inches is adequate) can be readily obtained with a variety of instruments. However, analog dial gauges may be somewhat complicated and easily misread; consider the gauges illustrated in Figure 17-46.

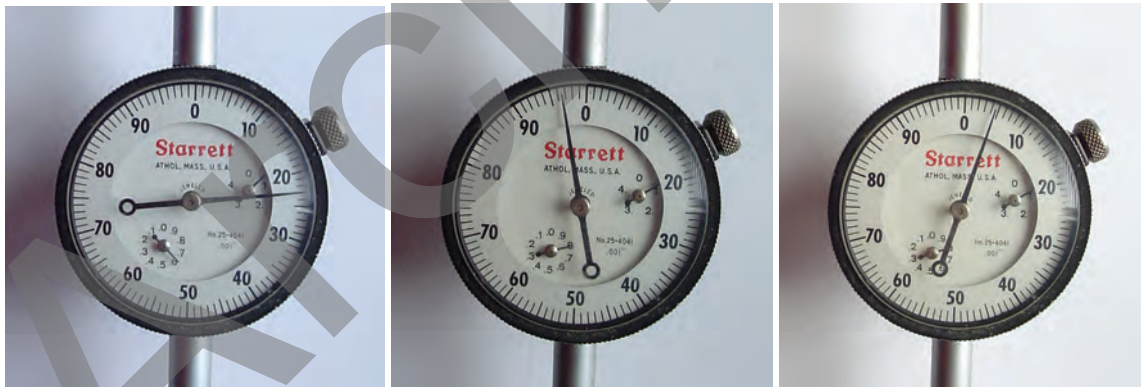


Figure 17-46 Dial Gauges: What Do You See? (answer: 0.623, 0.797, 0.804)

The greatest source of error is likely to be related to the stability of the reference system, which must be supported well away from the test shaft and any reaction foundations. The reference system should also be free from temperature distortions and wind or waves. The system illustrated in Figure 17-9 was supported in a direction orthogonal to the reaction system and constructed of timber, which is less prone to temperature fluctuations. Shading the reference system is also advisable on a sunny day. When working over water, it may be necessary to support the reference system on a pile foundation which is isolated from wave action by an isolation casing.



A backup system for displacement measurement may consist of a piano wire with a scale and mirror and/or optical measurements using a level. The scale is attached to the mirror which is mounted onto the test shaft, and allows the observer to make a consistent reading of the scale relative to the wire by aligning the image of the wire with the reflection of the wire in the mirror. Optical measurements using a surveyor's level may be used as a backup and to observe movements of the reaction shafts or piles, but the surveyor's level generally does not provide sufficient precision for use as the primary measurement system.

Other methods include the laser system with the photo-voltaic sensor (laser target) described in Section 17.2.2.3.1 and illustrated on Figure 17-27. This system is commonly used as the primary displacement measurement for the Statnamic loading system because it can provide thousands of measurements per second relative to a position that is far enough away to avoid vibrations.

Double integration of acceleration measurements are used to provide the primary means of displacement measurement during the high strain dynamic test and as a backup measurement for the rapid load (Statnamic) test. The permanent set obtained during a high strain dynamic test is checked after several blows using a measurement of marks on the test shaft against a reference system such as a piano wire.

#### **17.2.3.2.2 Below Grade**

Telltales may be used to obtain measurements of displacement below the top of the shaft. Telltales consist of unstrained rods extending through vertical tubes to a mounting position below grade. Dial gauges or electronic displacement transducers can then be mounted on each rod to measure the displacement at various points below the top of shaft, as illustrated in Figure 17-47. Telltales are often used with bi-directional (O-cell) tests to measure shaft movements above and below the O-cell.

It is also possible to determine displacements below grade from strain measurements; the integration of strain as a function of length along the shaft provides a measure of displacement of one point along the shaft relative to another. With reliable measurements of displacement at the shaft top and strain measurements along the shaft length, it is possible to determine the displacement at any point below the top of the shaft.

In some cases embedded accelerometers have been used to obtain displacements as a function of time in a rapid load test or high strain dynamic load test.

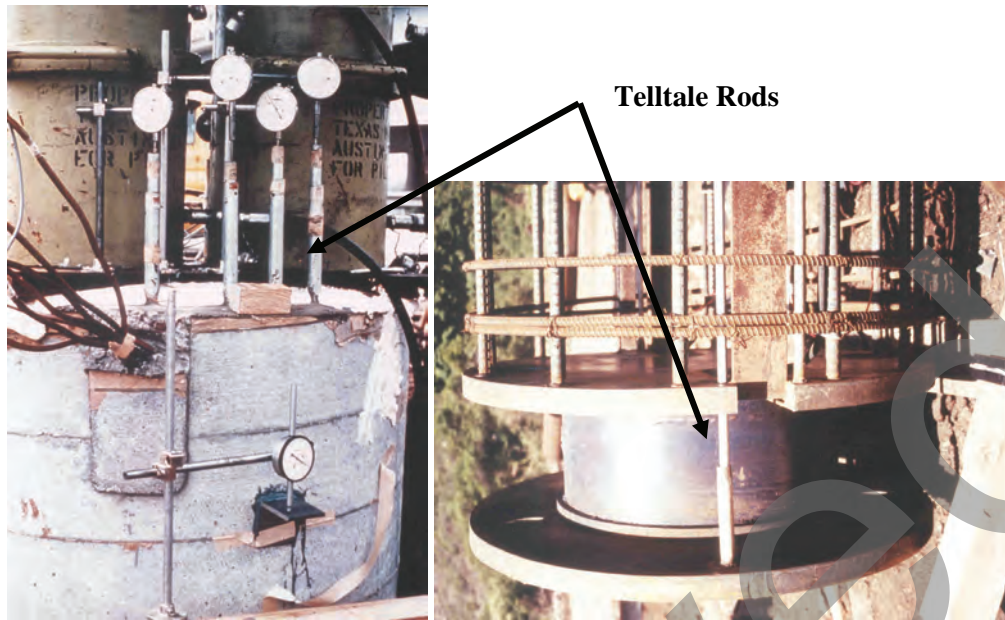


Figure 17-47 Telltales for Measurement of Displacement Below Shaft Top

### 17.2.3.3 Measurement of Strain

Strain measurements are a key component of axial load tests to determine load transfer. Several types of strain gauges may be used, as described in the following sections. The reliability of the measurement of strain may be excellent, but the interpretation of load transfer from the measurements is less reliable because of the physical characteristics of the drilled shaft. A discussion of the interpretation of strain data follows the discussion of strain measurements.

Most strain gauges used in drilled shaft applications are mounted on “sister bars” as illustrated in Figure 17-48. The sister bar typically consists of a #4 reinforcing bar about 4 ft long with the gauge mounted near the middle. The bar is intended to bond to the concrete via the development on either side of the gauge so that the measurement of strain on the bar reflects the average strain in the drilled shaft at that location.

#### 17.2.2.3.1 Resistance-type Strain Gauges

Resistance-type strain gauges are composed of a “foil” gauge that is bonded to the sister bar, and which has the properties of varying resistance as the gauge is strained in a specific direction. The gauge illustrated at left in Figure 17-49 may typically be  $\frac{1}{4}$  to  $\frac{1}{2}$  inch in length, has lead wires soldered to the connector tabs at the bottom, and is sealed for waterproofing after bonding to the sister bar. Gauges are arranged to form a circuit called a “Wheatstone” bridge as illustrated at right in Figure 17-49. In a typical “quarter bridge” application, the active strain gauge makes up one component of the bridge and the other three “dummy” gauges complete the circuit at the location of the data logger. As the resistance of the active gauge changes, a voltage is measured at the location in the circuit as shown, and this variation in voltage is calibrated to the strain at the gauge location for a known applied voltage level. It is possible to use multiple active gauges on a single sister bar to form a “half bridge” or even a “full bridge” circuit; use of multiple active gauges can increase the resolution of the measurement, although the quarter bridge is usually of sufficient precision for drilled shaft load testing. A precision of  $\pm 1$  microstrain ( $10^{-6}$  inch/inch) is typical with a quarter bridge circuit.

Resistance type strain gauges are inexpensive and reliable if water-proofed properly, but their greatest advantage is perhaps the fact that these gauges can be sampled thousands of times per second. Therefore, resistance gauges are ideal for dynamic measurements. The externally mounted strain sensor shown in Figure 17-36 also uses resistance type gauges. A limitation includes the fact that the electrical circuit can be affected by electrical noise in the area. A quarter bridge circuit includes some length of wires within the circuit and the measurements could be affected by changes in resistance within the circuit due to heat or other effects. A full bridge circuit within the gauges can be designed to be self-compensating for temperature, although of course the sister bar and drilled shaft can vary in length with changes in temperature or concrete shrinkage. The entire circuit is quite sensitive to moisture and must be carefully sealed.

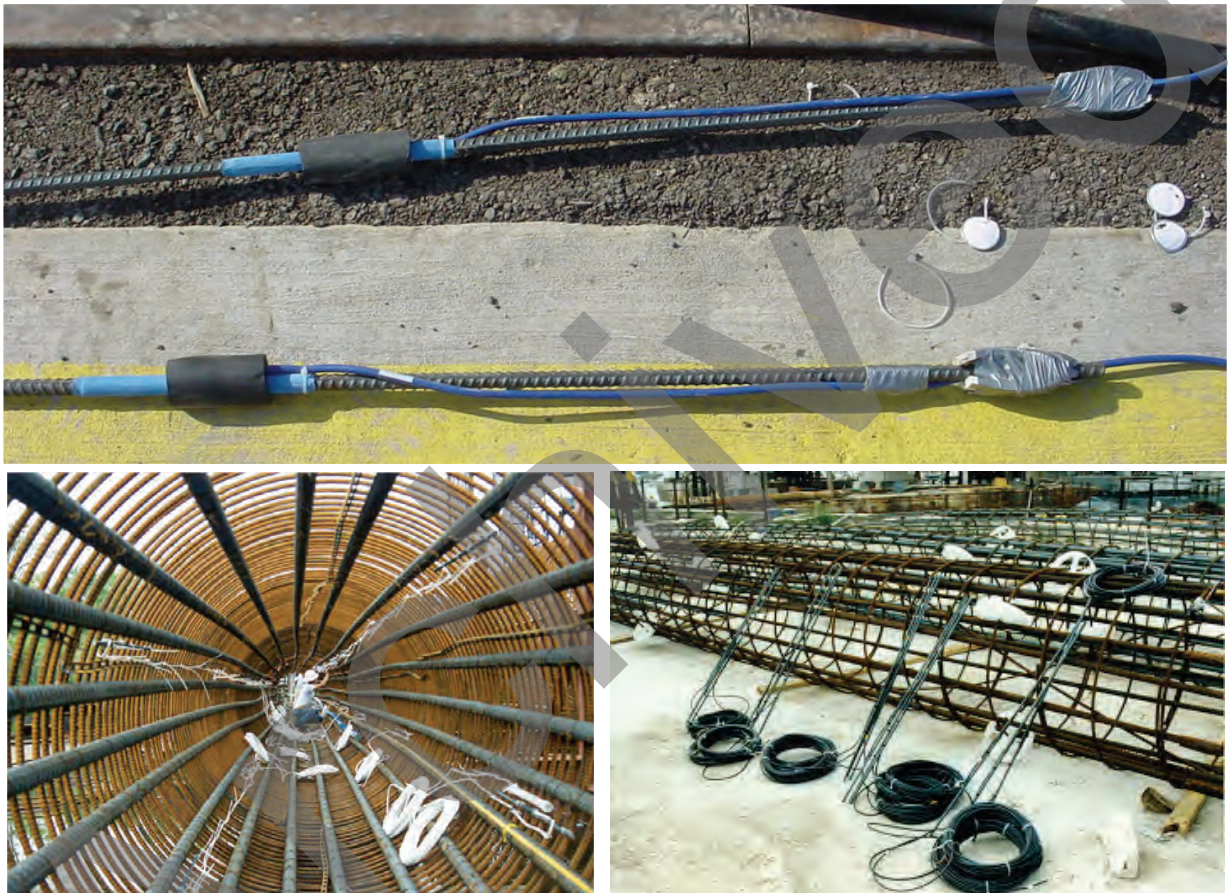


Figure 17-48 Sister-bar Mounted Strain Gauges Placed in Drilled Shaft Reinforcement

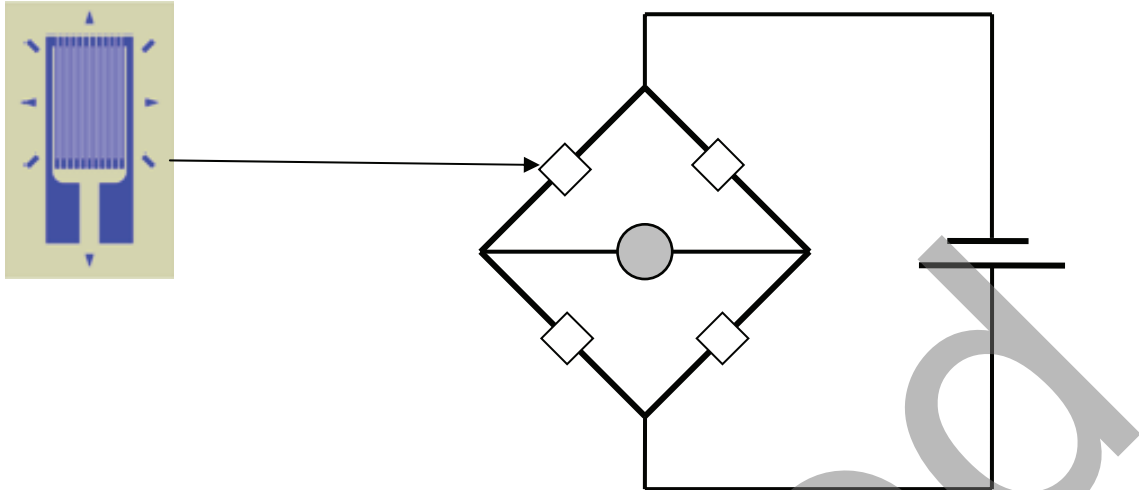


Figure 17-49 Resistance Type Strain Gauge

### 17.2.3.3.2 Vibrating Wire Strain Gauges

Vibrating wire gauges provide a measurement of strain by correlation with the harmonic frequency of a wire which makes up the gauge. These instruments are mounted on a sister bar for installation in a drilled shaft in a manner similar to resistance gauges and as illustrated on Figure 17-50. The wire within the gauge is stressed to some predetermined level, much the same as a guitar string, and a change in length of the gauge will result in a change in the “pitch” or harmonic frequency when the gauge is “plucked” by an electronic device. The vibrating wire gauge has a specific range of strain over which it can measure, and the pre-set frequency can be adjusted within this range at the time of manufacture in order to provide a greater range in compression (which will reduce the tension in the wire) or tension (which will increase tension). The harmonic frequency of the wire and the calibration to strain is affected by temperature, and therefore these gauges must always include a thermocouple for measurement of temperature at the time the strain is measured.

The data logging equipment for vibrating wire sensors is different than would be used for resistance type gauges, for obvious reasons. Each measurement of each gauge involves an electrical instruction to “pluck” the gauge and a short period of time (less than a second) for the system to monitor and measure the frequency of vibration of the gauge. Although the strain measurements can be obtained very quickly relative to the requirements of a static test, the response time required for these gauges precludes their use for rapid or dynamic load tests.

Advantages of vibrating wire type strain gauges include their reliability and stability for long term measurements, and relatively low sensitivity to electrical noise and moisture.

### 17.2.3.3.3 Fiber Optic Strain Sensors

Fiber-optic tubes have been successfully embedded in bridge decks and other concrete structures to measure the distribution of strain. Gratings can be inscribed at various points on a fiber-optic tube, as illustrated in Figure 17-51 and these reflect coherent laser light at varying wave lengths depending on the strain at the location of the grating. Fiber-optic gauges can also be mounted on sister bars like conventional gauges, and

this method extends the effective length of the gauge beyond the small grating spacing. Although fiber-optic strain sensors are less commonly used at present, they are suited to the measurement of strain (and therefore load) distributions in drilled shafts during loading tests, particularly tests conducted over long durations, since they can be made to be very stable. They are adaptable to multiplexing of data to the data acquisition unit, and many sensing locations can be established within the shaft at a fraction of the cost of other types of strain sensors. The disadvantages are that expert interpretation is still required and that the data acquisition equipment, although reusable, is initially expensive. Fiber-optic sensing should be considered for long-term monitoring of load transfer patterns in drilled shafts that are in service. For the reader interested in pursuing this type of instrumentation, an excellent overview of fiber-optic sensors for concrete structures is given by Merzbacher et al. (1996).



Figure 17-50 Vibrating Wire Type Strain Gauge

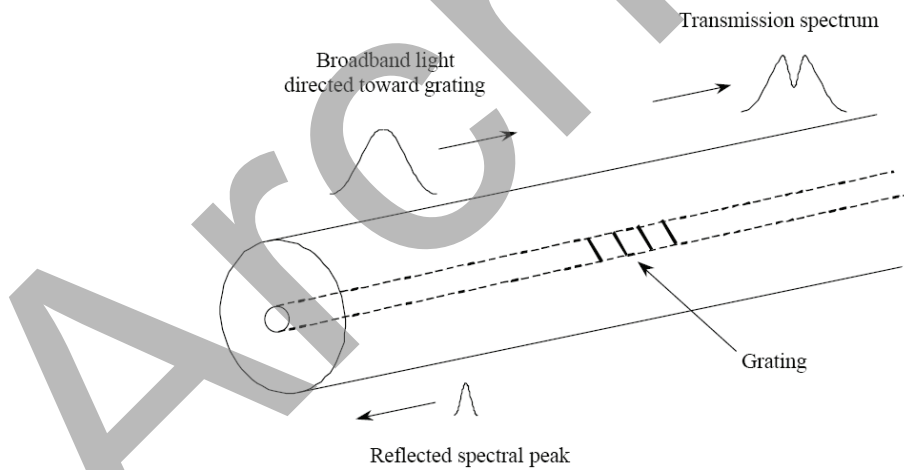


Figure 17-51 Fiber Optic Strain Gauge with Bragg Grating (Schultz, et al, 2001)

#### 17.2.3.3.4 Extensometers

Extensometers can be used to measure strain by obtaining a measurement of displacement between two points along the length of the shaft. The gauge length is thus the distance between the two points and the average strain is the relative displacement divided by the gauge length. Telltales could be used for this purpose, but

the displacement measurements are usually too crude and the gauge length too long to provide measurement of strain which is useful for determination of load transfer. However, LVDT's can be anchored at multiple points along a borehole or tube within the drilled shaft to provide accurate measurements of relative displacement. These devices can be recoverable and thus offer economy for multiple use applications relative to embedment gauges. These types of instruments have a history of use in the mining industry and are useful for other geotechnical applications such as settlement monitoring of embankments. However, the strain measurement in a drilled shaft is generally less precise relative to embedment gauges, and the instruments are still relatively expensive.

### 17.2.3.3.5 Interpretation of Strain Data

The purpose of the strain measurement is to obtain a measure of the axial force in the shaft at the point of each measurement so that the load transfer to the soil between measurement points can be determined.

The reliable measurement of strain at a point along the length of the shaft is best achieved by averaging the measurements of two or more embedment gauges at a given elevation. If there is eccentricity in load or bending stress in the shaft, the strain will vary across the cross section of the shaft. Averaging two or four separate gauges can eliminate the effects of bending. In addition, the use of multiple gauges provides redundancy in the case of a damaged or inoperable gauge.

For a given strain measurement, the force in the shaft is determined according to Equation 17-8:

$$F = \varepsilon(AE) \quad 17-8$$

where:  $F$  = axial force in the shaft  
 $\varepsilon$  = measured average axial strain  
 $A$  = area of cross section  
 $E$  = modulus of elasticity of drilled shaft

Even if the strain measurement is extremely precise, the determination of the axial force is affected by the area of the cross section and the modulus of elasticity. The actual area of the shaft is not usually known with a high degree of accuracy, but the knowledge of the cross sectional area can be much improved with the use of a borehole caliper as described in Section 17.2.1.5. The actual modulus of elasticity of the concrete at the time of testing is dependent upon the compressive strength and the age of the concrete. Since a drilled shaft typically includes both concrete and steel reinforcement, the  $AE$  represents a steel/concrete composite section. In short, a cast-in-place reinforced concrete drilled shaft does not make a very accurate load cell, so the interpretation of the strain measurements to determine axial force must be tempered with judgment regarding the precision of the force determination.

Once the force is determined at the elevation of each strain measurement, a force vs length plot can be developed as illustrated in Figure 17-52. The top most point is the measurement from a load cell or calibrated jack, the remaining points below grade are interpreted from strain measurements. Each curve represents a measurement for a specific load atop the shaft at the top displacement shown in the legend.

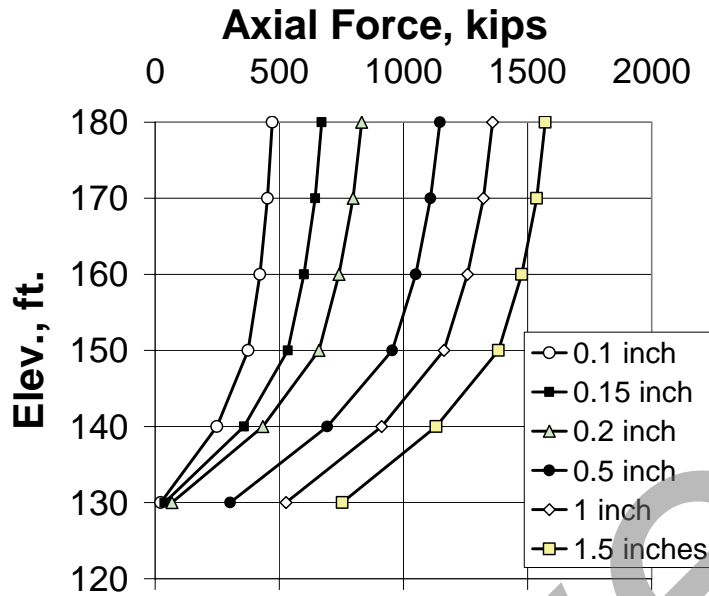


Figure 17-52 Example Plot of Force versus Elevation for a Top-Down Load Test

The difference between the force at each measurement elevation represents the load transferred to the soil or rock over the length of that segment. For instance, for the measurements corresponding to 1 inch of top displacement, the load at elevation 150 ft was determined to be 1,164 kips and the load at elevation 140 ft was determined to be 912 kips. Therefore, the load transferred to the soil in side resistance over this segment is  $1164 - 912 = 252$  kips.

The unit load transfer is determined by the maximum load transfer divided by the surface area of a segment of the test shaft. For instance, if the test shaft in Figure 17-52 had a 4-ft nominal diameter between elevation 150 ft and 140 ft, then the surface area of this segment is  $4 \cdot \pi \cdot 10 = 126 \text{ ft}^2$ , and the unit load transfer for the measurement at 1 inch of top displacement was  $252 \text{ kips} / 126 \text{ ft}^2 = 2.0 \text{ ksf}$ . The average displacement at a given segment location can be determined from the displacement at a measured location less the elastic shortening (average strain times length) from the measurement location to the segment. In this manner, unit load transfer versus displacement can be derived as illustrated on Figure 17-53.

A real example is illustrated in Figure 17-54. A schematic of the test setup is illustrated at top left. This shaft was 4-ft diameter and approximately 52 ft long and was installed through sandy soil to socket into a weak limestone formation in Tampa, Florida. Strain gauges were placed at three locations as shown. The top of shaft static load versus deflection response from a rapid load test is shown at top right. The load versus displacement is shown at lower left for the 12-ft long rock socket segment and at lower right for the shaft base (plus 2 ft of side resistance below the lowermost gauges).

The data derived from the instrumentation provide useful information about the behavior of this shaft that would be impossible to determine from the top of shaft measurements alone. Notice that most of the side shear in the rock is mobilized at less than  $\frac{1}{2}$  inch of movement and that the side shear exhibits a ductile and strain-hardening response up to the maximum displacement of over 1.5 inches. It is clear from these data that the side shear did not diminish in a brittle fashion at large displacement. The end bearing appears to indicate a soft toe condition in the initial  $\frac{1}{2}$  inch of displacement, possibly due to imperfect base cleaning, but then increases in a nearly linear manner up to the maximum displacement (1.5 inches is about 3% of the shaft

diameter). Additional end bearing resistance could likely be mobilized at even larger displacements, therefore the test did not achieve an ultimate yield in the geotechnical resistance of this shaft.

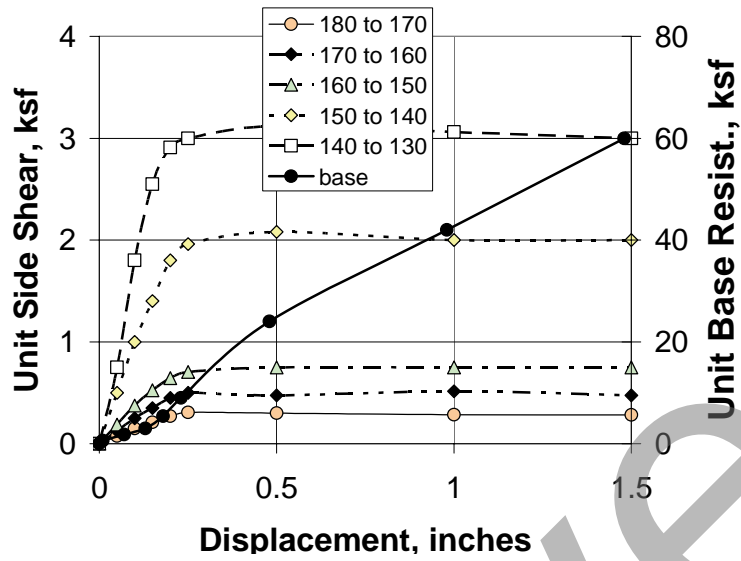


Figure 17-53 Example Plot of Unit Load Transfer Curves

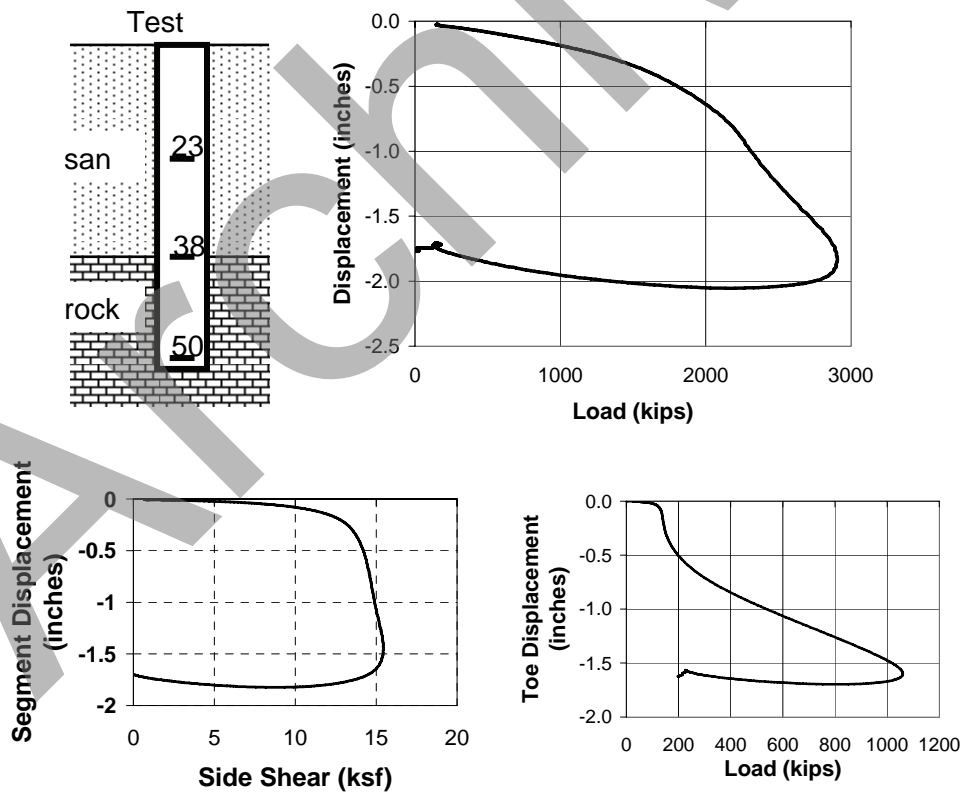


Figure 17-54 Data from an Instrumented Field Load Test



#### 17.2.3.4 Other Instrumentation

Accelerometers are often mounted on or within the shaft for rapid or dynamic load tests. Several different types of accelerometers may be used depending upon the frequency response required for the measurement (high frequency for impact tests, lower frequency for rapid load tests). Acceleration measurement is important to determine inertial resistance of a massive object. The accelerometer measurement may be integrated with respect to time to determine velocity, and integrated again to determine displacement as a function of time. Particle velocity proportional to force is an integral part of the signal matching process used to evaluate high strain dynamic load tests. The displacements obtained from an accelerometer measurement are useful for only short duration changes in displacement and must be referenced to a known displacement; accelerometers cannot directly measure static displacement.

Earth pressure cells are another type of instrument which have been used on rare occasions (usually research) with drilled shafts, usually mounted at the base of a shaft to measure shaft/soil base pressure at various points. Pressure sensors have limited usefulness with load testing because the distribution of pressure over the base of a shaft is not known and may be subject to variations related to soil or rock properties and construction techniques.

#### 17.2.4 Interpretation of Axial Test Results for Design

After completion of axial load tests and determination of values of resistance as described in previous sections of this chapter, the test results must be evaluated for the purpose of evaluating geotechnical design parameters. This evaluation must include a consideration of the possible variations in material properties and production shaft behavior across the site, and the effects of any differences between the conditions for design load cases and the tested conditions.

For unit side friction and base resistance, the values determined from the test shaft should be compared with the geomaterial properties at the specific load test location using an appropriate design method. The correlation of axial resistance to geomaterial properties may utilize one of the methods outlined in Chapter 13 of this manual or as developed from local practice. After this comparison is made, the designer may consider adjustment of empirical design parameters based on the site-specific test data. This “calibrated” correlation may then be used to compute performance of production shafts at other locations with similar geotechnical conditions. This process requires judgment based upon an understanding of the site geology and variability.

Another important issue may arise concerning the interpretation of measured values of resistance when there may be changes in stratigraphy and in-situ effective stress related to scour, grade changes, or fluctuation in groundwater levels. Some of the procedures used in design include empirical correlations which either do not directly account for changes in effective stress or do not account for post-construction reductions in effective stress, so engineering judgment is necessary.

Even in a cohesionless soil a reduction in vertical stress due to scour would not be expected to result in a proportional reduction in horizontal stress and subsequent axial resistance. The ratio of the change in horizontal stress,  $\Delta\sigma_h$ , at the shaft/soil interface to change in vertical stress,  $\Delta\sigma_v$ , due to unloading would be:

$$\Delta\sigma_h = K(\Delta\sigma_v) \quad 17-9$$

where K is the earth pressure coefficient for a condition of unloading. Because the soil is unloading, the soil is left with an increased overconsolidation ratio and a final value of horizontal stress,  $\sigma_h$ , which is greater in proportion to  $\sigma_v$  than would be anticipated for the soil prior to scour.

Intact rock formations are not likely to be significantly affected by short term changes in effective confining stress due to the large portion of strength derived from cementation or bond; however, the strength of decomposed rock or frictional joint surfaces within the rock mass may be sensitive to reduction in long term effective stress. Potential effects of future reductions in effective confinement must be evaluated based on an understanding of the geology and rock mass behavior.

## **17.3 LOAD TESTS TO MEASURE LATERAL RESISTANCE**

Drilled shafts are often selected for a project because of their great flexural strength and lateral load resistance. Where the design of the foundation is dominated by considerations of lateral loading, it may be appropriate to consider lateral load tests to validate or improve the design models. This section provides an overview of the most important considerations in planning field load tests to determine lateral resistance of drilled shafts, along with a description of various methods for performing lateral load tests, instrumentation for measurement of the performance of the shaft, and methods for interpreting the results of lateral load tests.

### **17.3.1 General Considerations in Planning Lateral Load Tests**

As with axial testing, the overall objectives must be established and the details of the test program defined with appropriate consideration of the production shafts that the test is intended to model. A discussion of objectives and many of these important details follows.

#### **17.3.1.1 Overall Objectives**

The first step in planning lateral load tests is to define the most important objectives of the testing program. For lateral testing, the most important objectives typically relate to measurement or verification of the design soil models that are most critical to the foundation performance. These parameters should be identified during the design process (Block 10 of the overall design process from Chapter 11) by performing parametric studies of the sensitivity of the design to various resistance components. In most cases the majority of the lateral resistance is derived from the soil resistance of the shallow strata. If the governing design case includes scour, then the test conditions must be established to evaluate the deeper strata. Measurements of the response of the shaft along the length below the point of loading may be very important in order to determine the distribution of lateral soil resistance so that the design can be refined.

It is important that a model be established to evaluate the response of the load test shaft so that the test can be designed to evaluate the lateral resistance of the soil relevant to the production condition. In general, the conditions of load and moment and rotational restraint at the top of the test shaft are not important. These shaft top conditions will likely differ from the production conditions but the objective of the test should be to evaluate lateral soil resistance and thus the soil model and parameters used for design. The test shaft may be designed with a greater structural strength compared to production shafts in order to allow a greater mobilization of the lateral soil resistance during the test.

#### **17.3.1.2 Location and Number of Test Shafts**

The considerations for location and number of test shafts are similar to those for axial load tests. For a large project, several test shafts may be utilized to perform tests that are representative of different “sites” across the length of the project. Note also that an axial test shaft can be utilized for lateral testing after completion of the axial load test. Lateral tests on an existing shaft are generally economical to perform.

### 17.3.1.3 GeoMaterial Properties at Test Location

It is very important to determine the properties of the geomaterial that is most important to the lateral response of the test shaft at the test location. A pre-test model of the expected behavior of the test shaft should be used to identify the strata that have greatest influence on the response so that the strength and stiffness characteristics of these materials can be investigated and subsequently correlated with the measured lateral resistance. The most important layers for lateral response may be different from those affecting axial resistance.

### 17.3.1.4 Scour or Changes in Overburden Stress Conditions

Scour and other changes in stratigraphy or in-situ stress conditions can have an even more profound impact on lateral resistance than on axial. If deep scour conditions are anticipated for the structure foundations, a lateral load test in a profile where scour has not occurred may serve only to test the lateral resistance of scourable strata and will be of little use in calibrating the design model. In such a circumstance, it may be difficult to find an appropriate location to conduct a meaningful lateral load test. Lateral tests may be conducted within an excavated cofferdam as illustrated on the right in

Figure 17-55, but the lateral dimensions of the cofferdam may need to be fairly large to provide a representative condition. Lateral testing of a shaft constructed with an isolation casing, as illustrated on the left, is not representative of a condition of scour around the shaft. The overburden soil provides confinement and prevents the development of a passive failure wedge toward the exposed surface. In addition, it may be difficult to isolate the lateral resistance of the soil acting on the isolation casing and through some portion of soil between the casing and the test shaft.

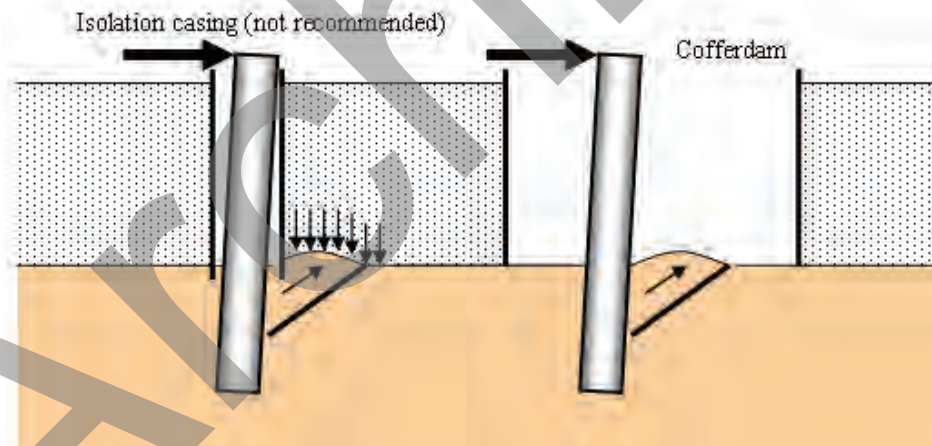


Figure 17-55 Schematic Diagram of Lateral Test where Scourable Overburden is Present

Based on these considerations, it may sometimes not be practical or economical to perform lateral load tests for foundations where deep scour is anticipated, unless a location can be found where similar foundation soils are located reasonably close to the surface. Where it is impractical to conduct lateral load tests, it may be appropriate to assume conservative parameters in the foundation design.

### **17.3.1.5 Construction of Test Shaft**

Construction of a lateral test shaft in a manner similar to that of production shafts is important in several key respects that may differ from axial test shafts. The use of oversized temporary casing and the resulting contact between the shaft and the soil within shallow strata may have little influence on axial resistance but is very important for lateral response. If temporary casing is installed in an oversized hole and then left in place, there could be a gap around the top of the shaft; this gap should be backfilled with grout in a manner consistent with the production shafts. If a temporary casing is left in place, this casing may contribute to the flexural stiffness of the shaft and must be taken into account in the computer model of the load test configuration.

### **17.3.1.6 Use of Prototype Shafts**

In general, prototype test shafts that are smaller in diameter than the production shafts are not recommended for lateral load testing. Smaller diameter test shafts are more strongly influenced by soils at a shallower depth than would be the case for a larger diameter production shaft. In addition, the flexural stiffness of the shaft is proportional to the 4<sup>th</sup> power of the shaft diameter, so a smaller diameter test shaft does not have sufficient stiffness to transfer stress to the depths that would be influenced by a larger production shaft.

### **17.3.1.7 Group Considerations**

Considerations for groups of drilled shafts subject to lateral load are described in Chapter 14, and typically include some modification of the lateral p-y response to account for group effects from overlapping zones of passive soil resistance. Since a lateral load test is most often performed on an isolated shaft, the application of the results to design of production shafts in a group would require modification of the lateral resistance model derived from the test. The shafts in a group will transfer a greater portion of the load to deeper strata compared to the isolated test shaft because of the reduced soil resistance attributed to group effects.

## **17.3.2 Test Methods and Procedures**

Most lateral load tests are conducted as conventional static tests by jacking the test shaft laterally with a hydraulic cylinder. However, there are circumstances where other methods of lateral testing have advantages. The following sections describe the basic methods used to perform conventional lateral load tests on drilled shafts as well as rapid or bi-directional testing methods.

### **17.3.2.1 Conventional Static Loading Test**

A conventional lateral loading test is commonly conducted by either pushing the test shaft away from one or more reaction shafts or piles or pulling it toward the reaction. The load is applied either by a jack that pushes on the test shaft at ground level away from a reaction system or by a jack connected to the side of the reaction system opposite to the test shaft (or *vice versa*) and attached to a cable or tie that allows the test shaft to be pulled toward the reaction. The load is measured by a load cell that is positioned adjacent to the jack in a manner similar to that for axial loading tests. If two shafts are jacked apart (or together), it is possible to obtain measurements on both shafts simultaneously.

A photograph of a typical arrangement for a lateral loading test of a drilled shaft is shown in Figure 17-56. In this case the test shaft is a vertical, 30-inch diameter shaft that is being jacked away horizontally from a steel reaction beam that spans between two other reaction shafts of the same size. In this particular test, in stiff clay, the drilled shaft was pushed approximately 3 inches by a groundline shear load of about 50 tons.

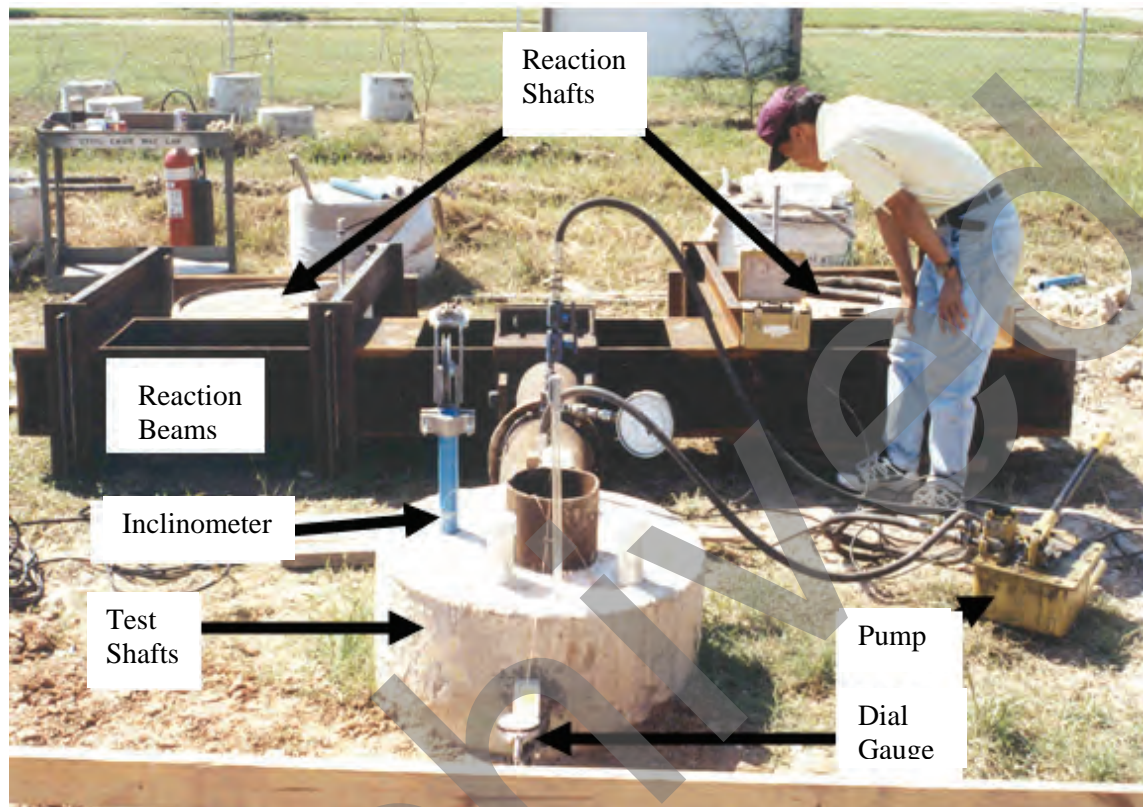


Figure 17-56 Conventional Static Lateral Load Test Setup

Several aspects of the lateral test setup are very important for both reliable test information and for safety during the test. Because the test and reaction shafts are subject to rotation at the top of the shaft, a change in alignment in the hydraulic loading system during the test is inevitable. The system must include a suitable bearing or clevis bracket to accommodate this rotation without imposing eccentricity in the jack or load cell and without risk of a bearing plate popping out of the system. If two shafts are pulled toward each other, then there must be a sufficient distance between that the passive soil zones do not overlap and affect the results.

The photo of Figure 17-57 illustrates a clevis bracket mounted to the end of the hydraulic ram, with the load cell mounted between two beams and the beam system attached to the test shaft. This test shaft was constructed by Kansas DOT with a rectangular extension above grade and a flat steel plate mounted into the extension for ease of connecting to the loading system.

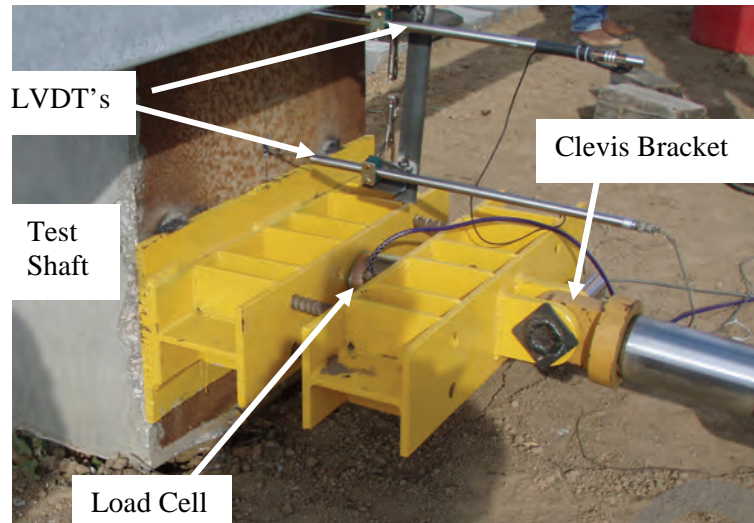


Figure 17-57 Clevis Bracket and Load Cell Mount for Lateral Loading

The lateral test setup shown in Figure 17-58 includes provisions for performing short term, two-way cyclic lateral loading, which might be an important consideration if the governing load case includes seismic or other extreme events that can produce cyclic loading (Brown et al, 2002). This system includes a large hydraulic pump with a hydraulic loading ram that is programmed to follow a controlled deflection versus time curve. The loading system also included a pinned connection to the two shafts, one of which was encased with a permanent steel liner at the surface. A steel casing provides a convenient surface for welding connections to the test shaft and increases the flexural stiffness of the shaft.

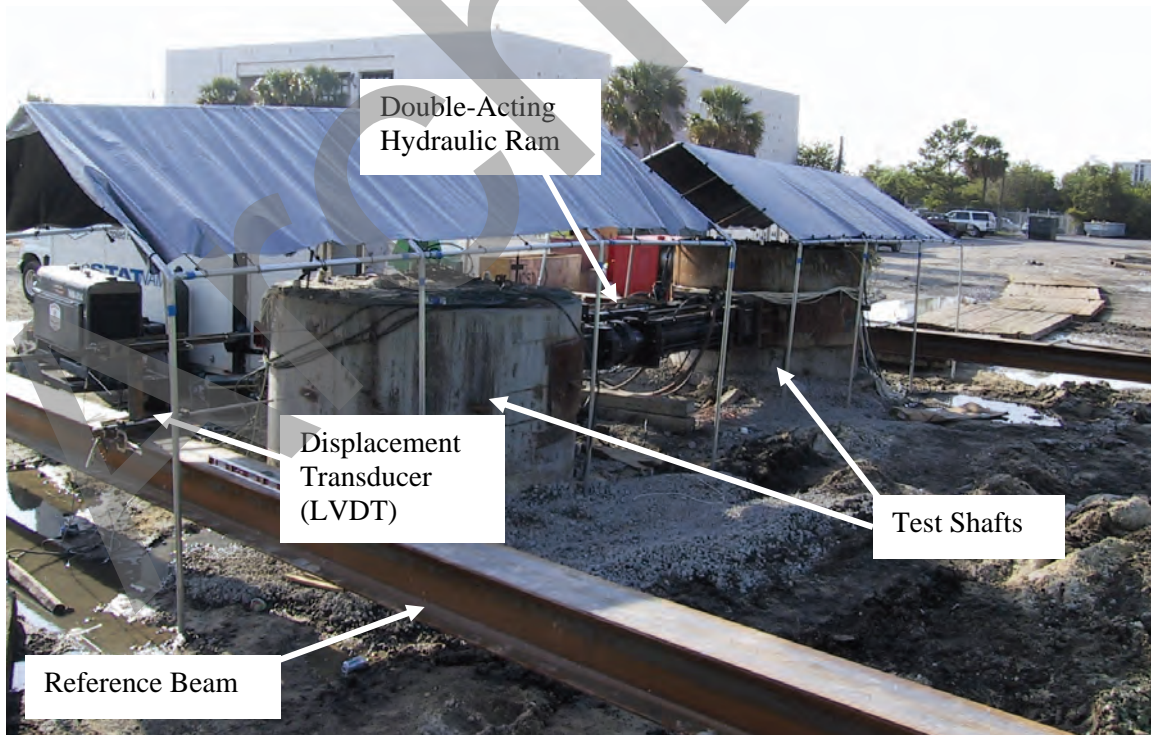


Figure 17-58 Cyclic Lateral Load Test Setup

### 17.3.2.2 Bi-Directional Testing

Bi-directional lateral load tests have been performed by inserting an Osterberg cell vertically into a rock socket, casting concrete around the cell and using the cell to jack the two halves of the socket apart (O'Neill et al., 1997). The lateral load applied to the geomaterial per unit of socket length is easily computed by dividing the load in the cell by the length of the test socket, which is approximately the length of heavy steel plates that are attached to each side of the cell. Two arrangements for such a test are shown in Figure 17-59. The cell at left was installed into a 6-ft diameter socket into sandstone at a depth of around 100 ft below the surface. The pair of cells in the photo at right were installed into a socket which was 8-ft diameter and 15-ft long into a chalk formation approximately 60 ft below grade. The steel beams connect the two cells which were jacked independently to maintain equal lateral displacement along the length of the socket and to split the shaft vertically, pushing the two halves apart. Lateral displacement is measured by using sacrificial LVDTs that connect between the plates and measure the opening between the plates.



Figure 17-59 Bi-directional Lateral Testing Apparatus Using Embedded O-cells

This test is not a direct simulation of a laterally loaded drilled shaft in flexure, but rather a type of in-situ test of the lateral resistance of the geomaterial within a specific formation subjected to a load of a size similar to a drilled shaft. The method allows the site-specific evaluation of the lateral response of a deep stratum which might be subsequently subjected to lateral loads from drilled shafts, including shafts in a large group or after exposure of the formation from scour. The interpretation of test results must include an evaluation of the effects of removal of overburden or scour effects, as discussed in other sections of this chapter.

### 17.3.2.3 Rapid Load Test

Drilled shafts have also been tested recently by mounting Statnamic devices on skids horizontally adjacent to the shaft and loading with a pulse of ground line shear (O'Neill et al., 1997; Rollins et al., 1997). This type of test can be more economical than the conventional test because the need for a reaction system is avoided. The system, illustrated in

Figure 17-60, is capable of applying lateral loads in excess of 1,000 tons, thus providing a capability of testing full size shafts of large diameter. Rapid loading may also be more appropriate than the conventional test when the type of design loading being considered is a rapid or impact loading (such as seismic, vessel or ice impact). A method of analysis of lateral rapid loading tests is described by Brown (2007) which includes a means of accounting for inertial and rate of loading effects.

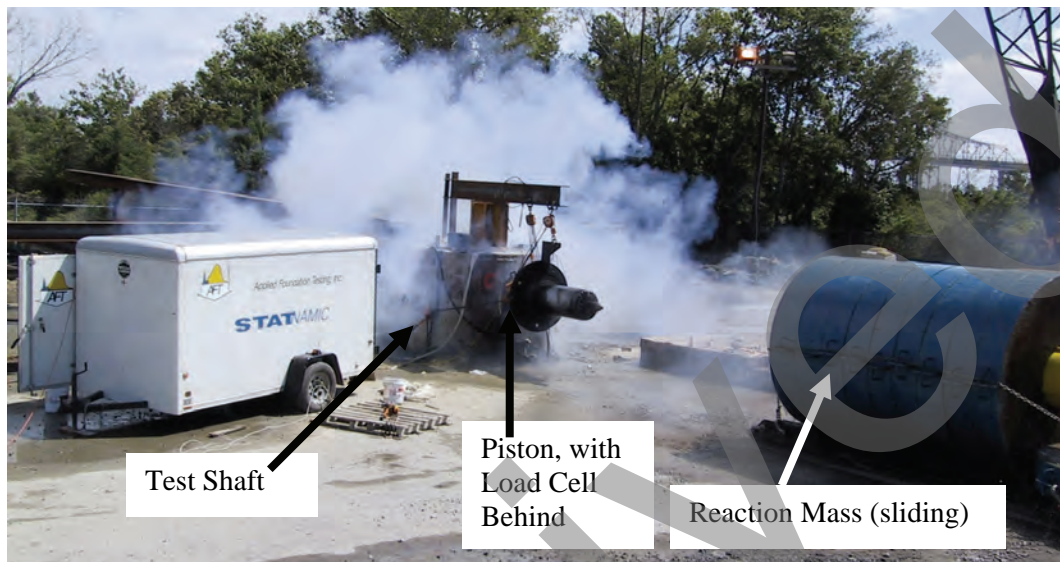


Figure 17-60 Rapid Lateral Load Test

### 17.3.3 Instrumentation

Much of the instrumentation used for lateral load testing is similar or identical to that used for axial load tests and described in previous sections of this chapter. Some aspects of instrumentation specific to lateral load testing are described below.

#### 17.3.3.1 Measurement of Load

Load is applied and measured with hydraulic jacks and load cells in conventional lateral load tests similar to that for axial tests with a couple of noteworthy differences. The jack must operate in the horizontal direction without leaks or problems related to the orientation of the jack, and the connection to the test shaft must be capable of accommodating a significant amount of rotation as described in Section 17.3.2.1. The magnitude of the load is often smaller, but the magnitude of the displacement in a typical lateral test may be much larger than in a vertical test.

Load cells are preferred for measurement of the load, with backup from the hydraulic pressure on the jack. For the rapid lateral loading using the statnamic device, a load cell is incorporated into the system. For bi-directional testing using the O-cell device, the pressure in the cell is calibrated to load.



### 17.3.3.2 Measurement of Shaft Displacement

Lateral displacement of conventional lateral static and rapid load tests may be measured using displacement transducers (dial gauges or LVDTs) mounted on a reference beam. Where large lateral motions are anticipated, these may need to be of unusually large travel, such as the LVDT shown in Figure 17-61. Long travel linear potentiometers (a variable resistor) may also be used for this purpose; some of these units are fabricated with a spring-loaded tension wire which can be extended to measure movements of several feet. Horizontally oriented accelerometers may also be mounted on the test shaft to measure lateral displacement during a rapid lateral load test.

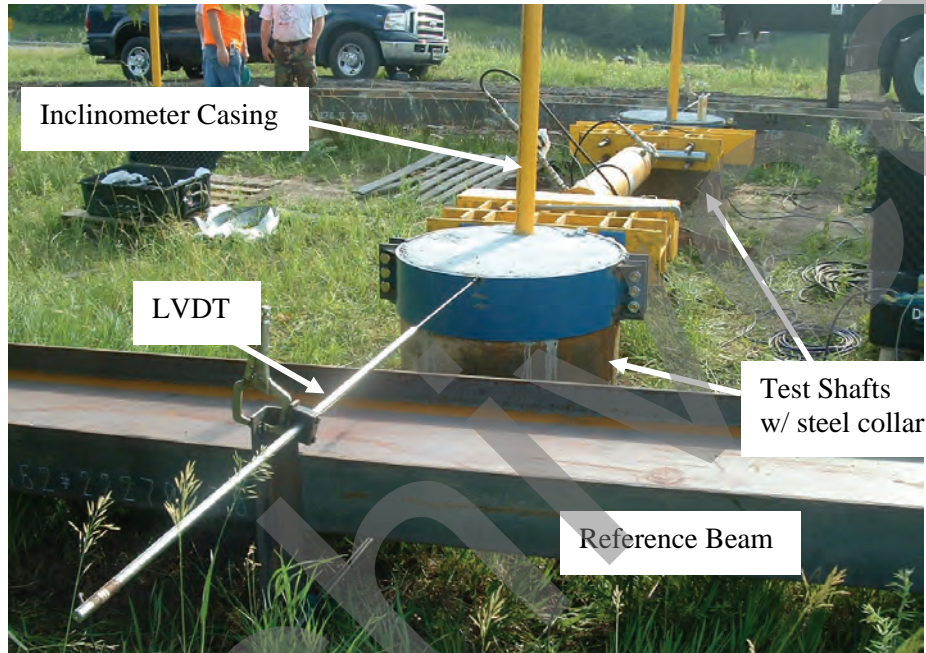


Figure 17-61 Long Travel Displacement Transducer and Inclinometer Casing

It is important to obtain measurements of lateral displacement along the length of the shaft in order to properly interpret the lateral test results. Fortunately, these measurements are easy and inexpensive to obtain by connecting a grooved inclinometer casing into the longitudinal reinforcing cage as shown on the left of Figure 17-62 to provide access. A pre-test measurement of the vertical profile of the shaft is obtained using an inclinometer (instrument for measuring slope for a near-vertical orientation) and used as a baseline for the test shaft in the same way that this instrument might be used in slope stability studies or for measurement of lateral movement of a wall. The lateral displacement relative to the bottom of the shaft can then be obtained during the test using the inclinometer, as illustrated on the right in Figure 17-62. Note that for a relatively short test shaft, the base of the inclinometer casing (the reference point for lateral displacement determination located near the base of the shaft) may not remain at zero displacement. In such a case, the relative displacements must be adjusted to a known point above grade at the location of the reference system measurement. In order to obtain the maximum sensitivity of the instrument, the casing should be positioned so that one set of internal grooves align with the direction of lateral loading. Also, it is desirable for the casing to be positioned at the neutral axis of the shaft to avoid or minimize axial strain effects on the inclinometer readings.



Figure 17-62 Measurements of Lateral Displacement in a Lateral Test Shaft below Grade Using an Inclinometer

In order to obtain lateral displacement measurements with an inclinometer, it is necessary that the loading be stopped and held at a constant displacement during the 20 to 30 minutes that may be required to perform the inclinometer profiling. An alternate and faster method to obtain these measurements is to suspend an array of inclinometer sensors in the casing, and to monitor these sensors using a data logger. A sensor array in the process of assembly is illustrated in Figure 17-63 in preparation for placement into the casing of a test shaft. The sensors are attached to spacer rods to separate the sensors to the desired spacing.

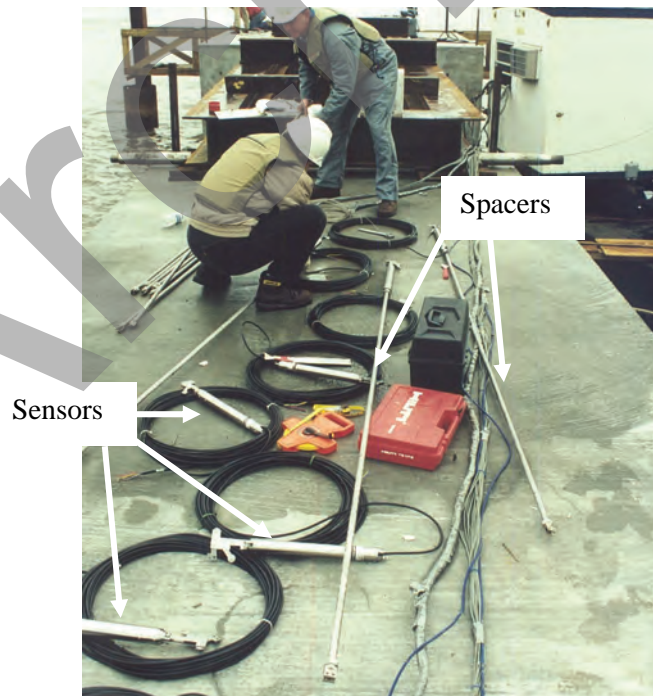


Figure 17-63 In-Place Inclinometer Sensors

Accelerometers may be used within an inclinometer casing during a rapid lateral load test to obtain a measurement of lateral motion at various points below the top of the shaft. An illustration of this instrument is provided in Figure 17-64. The wheels align with the grooves in the inclinometer casing and the mount allows the accelerometer to be oriented in the direction of loading. The string of down-hole accelerometers are monitored with the data acquisition system used to monitor the other instrumentation during the rapid lateral load test.

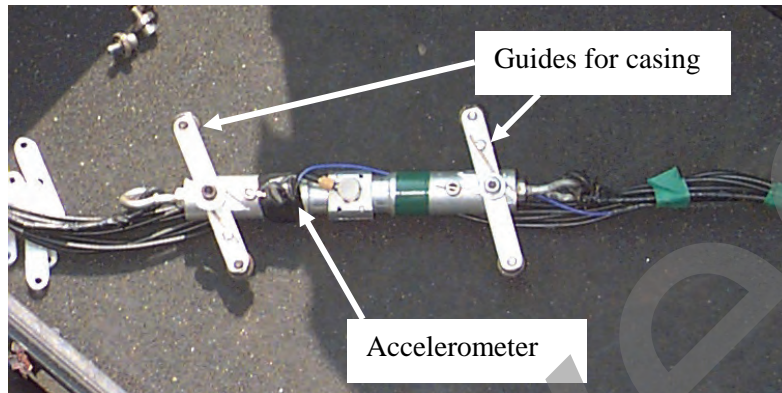


Figure 17-64 Down-hole Accelerometer for Displacement Measurement During Rapid Lateral Load Test

### 17.3.3.3 Measurement and Interpretation of Strain

Strain measurements during a lateral load test may be obtained using the same type of sister-bar mounted gauges described in Section 17.2.3.3. However, the objective of strain measurements during a lateral test is to obtain a measurement of the bending moments within the shaft. If gauges are mounted on both the far and near sides of the shaft in the direction of lateral loading, measurements of compression and tension are obtained as illustrated in Figure 17-65.

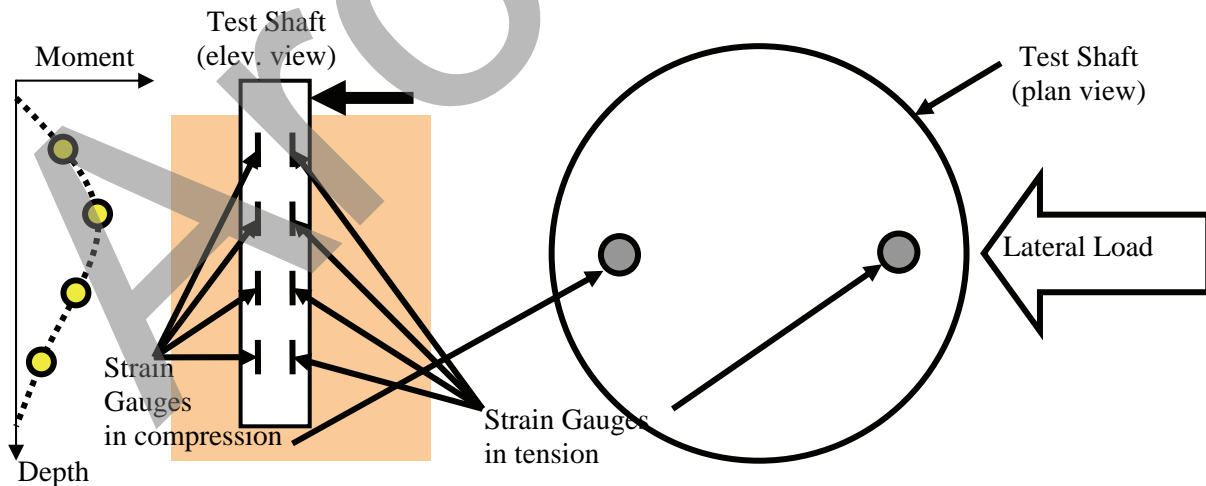


Figure 17-65 Strain Gauges to Measure Bending Moments

For a simple elastic beam, the bending moment,  $M$ , is obtained from measured strain,  $\epsilon$ , by:

$$M = \frac{\epsilon EI}{c} \quad 17-10$$

where:  $E$  = elastic modulus  
 $I$  = moment of inertia  
 $c$  = distance from neutral axis to the point of strain measurement

The tension and compression strains measured at equal distance from the center of an elastic beam in pure bending would be equal in magnitude and opposite in sign. A reinforced concrete drilled shaft does not behave as a nice simple elastic beam when subject to bending because the concrete will crack in tension and as a result the neutral axis shifts toward the compression side. The composite  $EI$  of the shaft changes dramatically with cracking, as described in Chapters 12 and 16. These chapters outline a method of estimating the nonlinear  $EI$  of the cross section for design purposes, and the methods described are generally conservative with respect to estimating the flexural stiffness (i.e., the  $EI$  is unlikely to be less than computed). In a real measurement of a test shaft, the actual  $EI$  is sensitive to:

- The “as-built” concrete compressive strength, which may be higher for the concrete cured in-situ than that of the cylinders made for quality control purposes,
- The actual tensile stress at which the concrete cracks, which may be higher than the relationships with compressive strength assumed for design,
- The actual concrete modulus, which may be higher than the typical relationship with compressive strength assumed for design,
- The actual “as-built” diameter of the shaft at the location of measurement,
- The effect of confinement provided by the soil or rock on the cracking in the shaft,
- The actual location of the reinforcing cage relative to the center of the shaft (if shifted toward the tension side, the reinforcing has a greater effect),
- The actual tensile strength of the reinforcement, which is normally higher than the 60 ksi minimum for GR60 reinforcing steel,
- The flexural strength, stiffness, and composite action of a steel casing left in place, even if the casing were not considered a part of the structural design of the shaft.

In summary, the nonlinear flexural strength and stiffness of a reinforced concrete column which is cast-in-place in a drilled hole makes unreliable the correlation between bending strain measurements and actual bending moments in the shaft. Bending strain measurements are useful in a lateral load test of a drilled shaft because they can help to identify the onset of cracking in the concrete (the tensile strains will suddenly increase relative to the compressive strains) and the location of the maximum bending moment and flexural yielding in the shaft.

#### 17.3.4 Interpretation of Lateral Test Data

The interpretation of the results of a lateral load test requires the use of a computational model as described in Chapter 12. A model of the lateral load test with the appropriate known boundary conditions at the top of the shaft (typically a zero moment and a known shear force) must be established with a best estimate of the actual shaft diameter and nonlinear flexural stiffness ( $EI$ ). In the experience of the writers, the actual flexural stiffness is often somewhat higher than that computed using the methods outlined in Chapter 12 for the

reasons cited in the previous section. The model is used to compute the load versus deflection response at the top of the shaft for each of several loads for which measurements have been obtained, and the deflection and bending moments versus depth below top of shaft for each of these loads.

The actual measurements of load versus deflection and deflection versus depth for each load are then compared to the model predictions, and the soil strength and stiffness characteristics (implemented through the p-y soil or rock model used for design) are adjusted as required to obtain a reasonable agreement. An overestimate of displacements in the model would reflect a conservative soil model. The shaft top movements in the model might fortuitously indicate good agreement with the measured deflections at the top of the shaft, but if the displacement profile below grade is not in agreement then the distribution of soil resistance in the model is not correct.

It should be noted that an underestimate of the flexural stiffness of the as-built test shaft could lead to an overestimate of the strength and stiffness of the soil model. If the shaft response is stiffer than expected because the flexural stiffness of the test shaft is better than expected, it might be easy to erroneously attribute this improved response to stronger soil. Therefore, it is imperative that the flexural strength and stiffness of the test shaft be appropriately modeled.

Once the designer is satisfied that the soil model provides reasonable or conservative agreement with the test measurements, the model can be used with the appropriate boundary conditions for production shafts as outlined in Chapter 12. Variations in stratigraphy across the site should be determined by the site exploration and included in the model for each foundation as part of the final design process.

If lateral load tests are considered for a project, they should be performed during the project design phase. Considering the time constraints during construction, there likely would be insufficient time available to modify the foundation design to incorporate the findings of a construction-phase lateral load tests program. If a construction-phase lateral load test program is required, the foundation design should be reasonably conservative with respect to lateral soil properties in order to minimize the risk of construction delays resulting from unexpected load test results.

## **17.4 SUMMARY**

This chapter has provided an overview of load testing techniques, measurements, and strategies for interpretation of results for design purposes. Because of the great advances in load testing technologies in recent years, field load tests offer designers a great opportunity for improved economy and reliability of drilled shaft foundations if the tests are used effectively and interpreted appropriately.

Archived

This page is intentional left blank.

## CHAPTER 18

### GUIDE DRILLED SHAFT CONSTRUCTION SPECIFICATION

This chapter provides a guide specification for the construction of drilled shaft foundations. These specifications are adapted primarily from the revised specification for “Section 5 - Drilled Shafts” (approved in July 2009) prepared by AASHTO Technical Committee T-15. These guide specifications also incorporate selected provisions noted in the FHWA publication on “Drilled Shafts: Construction Procedures and Design Methods” (O’Neil and Reese, 1999). In addition, provisions have been included reflecting the authors’ recent experience with the installation and testing of drilled shaft foundations. The guide specifications also include commentary that provides further guidance and possible alternative provisions to assist engineers in modifying the guide specifications to suit specific project conditions. The base specification and commentary from AASHTO are presented in standard font. Supplementary provisions and commentary from the authors and other sources are shown in *italics*.

These guide specifications are not intended to be used directly for project applications. Similar to other guide specifications, these specifications may not be completely suitable for the specific conditions encountered at a particular project. Considering the wide variability in project requirements for drilled shaft foundations, engineers should develop their own project-focused specifications using the specifications in this chapter only as a guide for identifying issues and provisions typically applicable to drilled shaft construction.

In addition to these guide specifications, the engineer should also consult other reference specifications for further assistance in developing specification provisions applicable to the unique conditions relevant to any particular project. These reference specifications may include:

- Standard Specification for the Construction of Drilled Piers, ACI 336.1R-01 (ACI, 2001)
- Standards and Specifications for the Foundation Drilling Industry (ADSC, 1999)
- Standard Specifications from government agencies, including state departments of transportation.

This chapter provides a general discussion of several key topics addressed in these guide specifications. Directly following the discussion is the guide specifications for construction of drilled shafts

#### **18.1 DESIGN CONSIDERATIONS**

A primary consideration in the development and application of drilled shaft specifications for any project is the relationship of shaft performance to the means and methods used for construction. Often, the resulting nominal resistance of a drilled shaft and the service characteristics of the completed shaft will be influenced by the method of drilled shaft installation and the care exercised in performing the work. Some examples illustrating this close relationship between construction techniques and drilled shaft performance include: poor bottom cleaning procedures that may considerably reduce the available base resistance; prolonged exposure of the sides of the drilled shaft excavation to slurry that may greatly reduce the available friction resistance; and failure to maintain a stable shaft excavation that may result in voids or soil inclusions in the shaft concrete and that may compromise the structural integrity of the completed drilled shaft; to note just a few. Unlike driven piles, where the resistance to driving provides a means of assessing the load bearing resistance of each pile, the proper performance of drilled shafts relies heavily on the consistent and repeatable application of the drilled shaft installation procedures

demonstrated by the successful performance of technique shafts (also sometimes called trial or method shafts) and test shafts. Accordingly, for drilled shaft specifications, emphasis must be given to:

- Qualifications of the drilled shaft contractor and key personnel assigned to drilled shaft construction,
- Proper planning of the work through the preparation and review of a Drilled Shaft Installation Plan (Section 18.8),
- The application of appropriate drilled shaft installation methods for the anticipated ground and groundwater conditions,
- Use of experienced and knowledgeable drilled shaft inspectors,
- Thorough and detailed documentation of all drilled shaft installation activities,
- Use of technique shafts and test shafts to verify design assumptions, as well as to evaluate the contractor's selected means and methods of drilled shaft construction,
- Integrity testing to verify the required structural integrity, and
- Clearly defined acceptance criteria and installation tolerances.

These and other specification topics are further discussed below.

## **18.2 QUALIFICATIONS OF DRILLED SHAFT CONTRACTORS**

Drilled shafts are typically highly loaded, and are frequently non-redundant elements used for structural support. To assure reliable performance, such elements require the high degree of workmanship which can be provided only by experienced drilled shaft contractors. Minimum drilled shaft contractor qualifications should be required by the contract documents based on prior contractor experience. In addition, when appropriate, the specifications should require the successful installation of a technique shaft or shafts at the start of construction to demonstrate the contractor's construction capabilities and proposed installation method. The degree of risk and complexity of a particular project should be used to establish qualifications for the project. These guide specifications contain suggested qualification requirements for a typical transportation project using drilled shaft foundations.

It is generally undesirable for a contractor to hire a drilled shaft specialist only to excavate the drilled shaft, while assigning the placement of steel and/or concrete to a different organization. The inevitable lack of coordination and increase in time that a drilled shaft excavation remains open prior to concrete placement as a result of such practice can severely impact the performance of the drilled shafts. Also, separating these operations invites disputes between the drilled shaft contractor and the prime contractor whenever there is a question regarding the integrity of the completed shaft (e.g., was a defect caused by improper concrete placement procedures or by use of an inappropriate concrete mix?). Construction of a drilled shaft includes excavation, placing steel and placing concrete. These are all critical operations that should be performed in a continuous manner by a single, qualified contractor.

## **18.3 CONSTRUCTION METHOD**

The construction methods to be permitted on a specific project (Chapters 4 and 5) must consider the ground and groundwater conditions, and the design requirements for ground resistance (i.e., reliance only on side resistance, only end bearing resistance, or combined side resistance and end bearing). These factors will largely influence the type of drilling equipment used, the method of excavation (wet or dry), the type of drilling fluid, the use of permanent or temporary casing, and shaft cleanout criteria, among



others. The drilled shaft construction methods, as well as design requirements, will then influence the concrete mix design and the method of placement. For wet excavations, for example, the specifications must include provisions requiring a concrete mix suitable for tremie placement; and must also include provisions for tremie concrete placement.

Fortunately, numerous combinations of equipment and procedures are available to permit successful installation of drilled shafts for any ground condition or design requirement. Specifications, therefore, should not needlessly restrict contractors in their choice of tools, equipment or construction method. To achieve a cost-effective project, the specifications must permit as much flexibility to the contractor as possible, within the constraints of the project and the existing site conditions.

#### **18.4 DRILLING FLUID**

Drilling fluid is an effective means of stabilizing drilled shaft excavations until either a casing has been installed or concrete is placed, as discussed in Chapter 7. The type(s) of fluid (mineral slurry, polymer slurry or water) specified should be appropriate for the anticipated ground conditions.

The properties of drilling slurry should be monitored and controlled during slurry mixing, during drilling, and also just prior to concrete placement. Primary concerns in slurry use are: 1) the shape of the borehole should be maintained during excavation and concrete placement, 2) the slurry does not weaken the bond between the concrete and either the side of the drilled shaft or the rebar, 3) all of the slurry is displaced from the drilled shaft excavation by the rising column of concrete, and 4) any sediment carried by the slurry is not deposited in the drilled shaft excavation or rising concrete.

The performance and effectiveness of the drilling fluid can be achieved through appropriate specification provisions, including: 1) identifying the types of drilling fluids that may or may not be used, 2) specifying a suitable range of slurry properties both during excavation and prior to concrete placement, 3) performing slurry inspection tests, and 4) construction of pre-production technique shaft(s) to evaluate the contractor's proposed wet excavation method.

#### **18.5 LOAD TESTING**

Considering the generally high axial resistance typical of drilled shaft foundations, the use of conventional static load tests using a dead weight or reaction frame to load the top of the drilled shaft is generally not practical. Bi-directional load cell testing (Section 17.2.2.2), in which a bi-directional load is applied by a hydraulic jacking mechanism cast within the drilled shaft, is a more practical and economical method for determining the axial resistance of a high capacity drilled shaft, and currently is a commonly used method for load testing drilled shafts. However, at present there are no ASTM standards for bi-directional load cell testing. Accordingly, until such standards are available, caution must be exercised in the planning, execution and interpretation of the results of load tests using this method. The guide specifications presented herein include interim specifications with suggested procedures for performing bi-directional load cell tests based on current general practice.

Drilled shaft test programs have also included rapid, compression force pulse tests (Section 17.2.2.3) and high strain dynamic tests (Section 17.2.2.4) for estimating the axial resistance of drilled shafts. Each of these methods estimates resistance along the drilled shaft by evaluating the dynamic response of the drilled shaft and the dynamic characteristics of the supporting ground. These types of load tests are addressed in ASTM test designation D 7383 for "Standard Test Methods for Axial Compression Force

Pulse (Rapid) Testing of Deep Foundations.” This standard covers load tests where the test load is applied as an axial compressive force pulse at the top of the drilled shaft using either a combustion gas pressure (ASTM “Procedure A”) or using a cushioned drop mass (“Procedure B”). The guide specifications presented herein refer to ASTM D 7383 when either of these types of load tests are specified or considered.

Lateral load tests are occasionally performed on drilled shafts to determine the response of the drilled shafts to lateral loading, or to determine the p-y resistance properties of the surrounding geomaterials. Procedures for performing lateral load tests by the static load method should be in accordance with the requirements of ASTM D 3966 for “Standard Test Methods for Deep Foundations under Lateral Loads.” At the present time there are no standards for performing lateral load tests by the bi-directional loading method (Section 17.3.2.2) or the rapid load test method (Section 17.3.2.3). Accordingly, until such standards are available, caution must be exercised in the planning, execution and interpretation of the results of lateral load tests using these methods.

## 18.6 INTEGRITY TESTING

Drilled shafts can experience construction defects such as necking, bulging, voids, honeycombing, loss of concrete cover, etc., particularly drilled shafts installed using the wet method of construction. Therefore, drilled shaft integrity testing should be an important part of many drilled shaft foundation projects. However, integrity testing should not be relied upon as the sole means for assessing the structural adequacy of the drilled shaft, but must be considered, along with proper design of the drilled shaft, proper shaft installation, and thorough construction inspection, as a key element of the overall QA/QC program.

Integrity testing may be specified for some or all of the following purposes, depending on the details of the drilled shaft foundation design:

- at the start of construction, to confirm the suitability of the contractor’s proposed shaft installation methods
- routinely, or periodically, during drilled shaft production operations to continue to assess the suitability of the contractor’s approved shaft installation method
- to evaluate the structural integrity of the shaft whenever there is a significant change to the contractor’s means and methods of drilled shaft installation
- to investigate drilled shafts that are suspected of having defects to the shaft concrete based on observations during shaft installation
- to evaluate the effectiveness of remedial measures performed on a drilled shaft

The methods available for integrity testing include both internal integrity test methods (Cross-hole Sonic Logging, and Gamma-Gamma Density Logging) and external integrity test methods (Sonic Echo and Impulse Response).

External integrity testing methods require a greater degree of interpretation and do not provide the same reliability as the internal methods. For example, in sonic echo tests, toe reflections may be observed to a depth of up to 30 shaft diameters in favorable conditions, but may be difficult to identify in deeper shafts. Defects such as cracks, bulging, necking or cold joints may reflect the low energy wave and prevent detection of deeper defects. Also, weak reflections may be observed for drilled shafts founded on or socketted into rock since the modulus of the rock may be comparable to, or greater than that of the concrete shaft.

Of the available test methods, Cross-hole Sonic Logging (CSL) is the preferred method since a) it provides test data for the entire length of the drilled shaft, b) it can be used to estimate the size and location of an anomaly, and c) when combined with tomographic imaging, can help develop an approximate 3D image of the anomaly. Accordingly, it is recommended that CSL testing be considered for most drilled shaft foundation projects. As a minimum, a drilled shaft integrity testing program should include CSL testing of all technique shafts and all load test shafts. CSL testing should also be specified for drilled shafts in a non-redundant foundation unit, for drilled shafts installed using the wet method of construction, and for drilled shafts with diameters or lengths greater than those commonly used in local practice.

For projects where CSL testing is not warranted at all drilled shafts, consideration should be given for installing CSL tubes in all drilled shafts, and performing CSL testing at random drilled shaft locations during the progress of foundation construction to confirm the continued success of the contractor's drilled shaft installation procedures. Installing CSL tubes in all shafts also provides the option for testing any shaft where defects may be suspected as a result of observations during shaft installation.

These guide specifications include provisions for CSL testing since this is a commonly used test method and one that requires installation of tubes within the shaft during shaft construction. If CSL testing is not specified, consideration should be given to including in the construction specifications provisions for performing external integrity testing by a qualified testing specialist to evaluate drilled shafts suspected of having defects in the shaft concrete based on observations during concrete placement operations.

## **18.7 CONSTRUCTION PHASE SUBSURFACE INVESTIGATIONS**

The design phase subsurface investigation program should be tailored to address the specific requirements of the drilled shaft foundation design and the existing site conditions. The data from the design phase investigation program should be included in the contract documents to obtain responsive bid prices for the work, and to reduce the risk of unanticipated conditions and differing site condition claims during construction. However, situations often arise where additional subsurface investigations will be required as part of the construction contract. Such situations may include cases where there are non-redundant drilled shafts that require confirmation borings at each shaft location; for shafts in rock to determine the specific depth and length of the rock socket at each shaft; and for sites with highly variable subsurface conditions that may not have been sufficiently defined during the design-phase investigation program.

The detailed requirements for performing construction-phase subsurface investigations are typically contained in a separate specification section which is then referenced in the section on Drilled Shafts.

## **18.8 DRILLED SHAFT INSTALLATION PLAN**

An essential element of any project that requires the installation of drilled shaft foundations is a Drilled Shaft Installation Plan. The Drilled Shaft Installation Plan effectively communicates to shaft construction personnel and field inspectors the project requirements for drilled shaft installation. The Plan also serves as a basis for identifying any unapproved modifications to the equipment and procedures used for installation and testing of the drilled shafts.

The Drilled Shaft Installation Plan is prepared by the contractor and submitted for the review of the owner and/or design engineer in advance of initiating any drilled shaft construction. The attached guide specification provides a list of the minimum information that needs to be included in a Drilled Shaft

Installation Plan. The Plan should be specific to the particular project and not just a standard list of general steps typical of drilled shaft construction. The Plan should fully document the equipment and procedures to be used in the work, allowing the engineer opportunity in advance of construction to confirm compliance of the contractor's proposed equipment and procedures with the contract documents; and to identify proposed practices that may adversely influence the nominal resistance or serviceability characteristics of the completed shafts

Following receipt of review comments, the contractor should revise and re-submit the Plan. Work at the drilled shafts should not proceed until the Plan is accepted.

During the course of the work, the Drilled Shaft Installation Plan should be updated and resubmitted to the owner and/or engineer for review and approval whenever there is a significant modification to the drilled shaft installation equipment or procedures. Field staff should always be provided with the latest approved version of the Plan to assure that the work is performed as intended.

## 18.9 MEASUREMENT AND PAYMENT

Two alternate methods of payment for drilled shaft excavation are typically specified, including unclassified excavation and separate payment for soil and rock excavation. The preferred approach, and the one reflected in the guide specification that follows, includes separate pay items for soil and rock excavation.

Unclassified Excavation: Unclassified excavation may be appropriate when little or no hard rock is anticipated on a project. It may also be a more practical approach in cases where the transition from geomaterials that can be drilled with standard techniques at a rapid rate to geomaterials that are difficult to excavate is hard to define or ambiguous. Unclassified excavation may also be preferred by some contracting agencies to reduce the administrative effort in tracking the separate pay items.

Specifying unclassified excavation may result in an increased contingency cost in contractor bids since the contractor assumes the risk of an increased length of difficult drilling. This concern can be addressed, but not completely resolved, by performing an appropriate design-stage site investigation and making this information available to the bidders.

Separate Payment for Soil and Rock: Separate measurement and payment for soil and rock excavation provides an equitable means of payment for excavation of hard rock that may require different excavation equipment or result in considerably slower excavation rate. This approach reduces much of the uncertainty in the contractor bids, and is therefore generally more economical than unclassified payment for excavation.

Separate pay items for soil and rock excavation should be defined in terms of the difficulty and rate of excavation. Often this is a subjective decision, related to the equipment used for excavation. To address this issue, the guide specifications suggest using an Unconfined Compressive Strength of 1,000 psi to define the division between soil excavation and rock excavation. Using this approach, a sufficient number of strength tests must be performed prior to and during construction to determine the strength of the various rock strata to be encountered.

An alternative approach used by some contracting agencies is to differentiate excavation pay items by the equipment needed to advance the hole. With this approach, standard or soil excavation includes hole advancement with conventional augers and drilling buckets. Special or rock excavation is paid when the

hole cannot be advanced with conventional tools, but requires special rock augers, core barrels, or other methods of excavation using unconventional tools.

When separate excavation pay items are used, the specification needs to carefully define the materials and/or excavation conditions (tools, rate of advance, etc.) that will be used to determine the appropriate pay item for shaft excavation. This approach also requires inspectors knowledgeable in classifying geomaterials and in shaft excavation methods to determine the appropriate pay item to apply as the excavation advances. In addition, this approach requires increased coordination with the contractor to obtain concurrence on pay quantities and to address disagreements that may arise regarding material classification.

Obstructions: Whether shaft excavation is paid as unclassified excavation or as separate items for soil and rock excavation, the specifications should include an additional pay item for obstruction removal. Obstructions are usually paid under a separate item since they typically require unconventional excavation techniques and interrupt the general excavation operations. Some agencies pay for obstruction removal at a factor of 2 or 3 times the rate that was bid per unit of depth based on soil drilling, some pay based on a report of the contractor's time and materials, and some use other methods.

Baseline Report: In particularly uncertain or variable ground conditions, consideration should be given to including a Baseline Report as part of the contract documents. As discussed in Section 2.4.5, a Baseline Report establishes the site conditions that can be expected and that will serve as the basis of the contractors' bid prices. The conditions defined in the report are then subsequently used to assess potential differing site conditions, and as a basis for determining payment.

## **18.10 SUMMARY**

A critical element of any drilled shaft project is the preparations of the technical specifications that appropriately address the specific conditions and requirements of the project. The guide specifications that follows can be used to identify the issues and provisions typically applicable to drilled shaft construction, and can be tailored to address project-specific requirements.

In addition, the information presented throughout this manual on the design and construction of drilled shafts provides valuable technical information that should be considered in the development of a construction specifications for drilled shafts.

## Section X - DRILLED SHAFTS

## COMMENTARY

### X.1 DESCRIPTION

This item of work shall consist of furnishing all materials, labor, tools, equipment, services and incidentals necessary to construct the drilled shafts in accordance with the Contract Documents and this Specification.

### X.2 SUBMITTALS, APPROVALS AND MEETINGS

At least four weeks prior to the start of drilled shaft construction, the Contractor shall submit four copies of a project reference list to the Engineer for approval, verifying the successful completion by the Contractor of at least three separate foundation projects within the last five years with drilled shafts of similar size (diameter and depth) and difficulty to those shown in the Plans, and with similar subsurface geotechnical conditions. A brief description of each project and the owner's contact person's name and current phone number shall be included for each project listed.

#### X.2.1 Experience and Personnel

At least two weeks prior to the start of drilled shaft construction, the Contractor shall submit four copies of a list identifying the on-site supervisors and drill rig operators assigned to the project to the Engineer for approval. The list shall contain a detailed summary of each individual's experience in drilled shaft excavation operations, and placement of assembled reinforcing cages and concrete in drilled shafts.

- On-site supervisors shall have a minimum of two years experience in supervising construction of drilled shaft foundations of similar size (diameter and depth) and difficulty to those shown in the Plans, and similar geotechnical conditions to those described in the geotechnical report. The work experience

Electronic versions of all submittals should be encouraged. All submissions should be made concurrently to all on the distribution list.

shall be direct supervisory responsibility for the on-site drilled shaft construction operations. Project management level positions indirectly supervising on-site drilled shaft construction operations are not acceptable for this experience requirement.

- Drill rig operators shall have a minimum one year experience in construction of drilled shaft foundations.

The Engineer will approve or reject the Contractor's qualifications and field personnel within ten working days after receipt of the submission. Work shall not be started on any drilled shaft until the Contractor's qualifications and field personnel are approved by the Engineer. The Engineer may suspend the drilled shaft construction if the Contractor substitutes field personnel without prior approval by the Engineer. The Contractor shall be fully liable for the additional costs resulting from the suspension of work, and no adjustments in contract time resulting from such suspension of work will be allowed.

#### X.2.2 Drilled Shaft Installation Plan

At least four weeks prior to the start of drilled shaft construction the Contractor shall submit four copies of a Drilled Shaft Installation Plan narrative for acceptance by the Engineer. In preparing the narrative, the Contractor shall reference the available subsurface geotechnical data provided in the Contract boring logs and any geotechnical report(s) prepared for this project. This narrative shall provide at a minimum the following information:

*A Drilled Shaft Installation Plan is an essential document that should be required for all projects that require drilled shaft foundations. The Plan should be specific to the particular project and not just a standard list of general steps typical of drilled shaft construction. The Plan should fully document the equipment and procedures to be used in the work, allowing the Engineer opportunity in advance of construction to confirm compliance of the Contractor's proposed equipment and procedures with the Contract Documents, and to identify proposed practices that may adversely influence the nominal resistance or serviceability characteristics of the completed shafts. A Drilled Shaft Installation Plan also effectively communicates to shaft construction personnel and field inspectors the project requirements for drilled shaft installation. The Plan also serves as a basis for identifying any unapproved modifications to the equipment and procedures used for installation and testing of the drilled shafts.*

*The Owner/Designer should review the list of Plan items identified*

*herein, and supplement the list, as appropriate, for each project.*

- Description of overall construction operation sequence and the sequence of drilled shaft construction when in groups or lines.
  - A list, description and capacities of proposed equipment, including but not limited to cranes, drills, augers, bailing buckets, final cleaning equipment and drilling unit. As appropriate, the narrative shall describe why the equipment was selected, and describe equipment suitability to the anticipated site and subsurface conditions. The narrative shall include a project history of the drilling equipment demonstrating the successful use of the equipment on shafts of equal or greater size in similar subsurface geotechnical conditions.
  - Details of drilled shaft excavation methods, including proposed drilling methods, methods for cleanout of the bottom of the excavation hole, and a disposal plan for excavated material and drilling slurry (if applicable). If appropriate this shall include a review of method suitability to the anticipated site and subsurface geotechnical conditions including boulders and obstruction removal techniques if such are indicated in the Contract subsurface geotechnical information *or Contract Documents*.
  - Details of the method(s) to be used to ensure drilled shaft hole stability (i.e., prevention of caving, bottom heave, etc. using temporary casing, slurry, or other means) during excavation and concrete placement. The details shall include a review of method suitability to the anticipated site and subsurface geotechnical conditions.
  - Detailed procedures for mixing, using, maintaining, and disposing of the slurry shall be provided. A detailed mix design (including all additives and their specific purpose in the slurry mix), and a discussion of its suitability to the anticipated
- When the Contract requires a minimum penetration into a bearing layer, as opposed to a specified shaft tip elevation, and the bearing layer elevation at each shaft cannot be accurately determined, insert the following: “Variations in the bearing layer elevation from that shown in the Plans are anticipated. The Contractor shall have equipment on-site capable of excavating an additional 20% of depth below that shown in the Plans.”
- Where the installation of drilled shafts will take place adjacent to existing sensitive installations prone to damage due to the instability of uncased drilled shaft holes or where subsurface soil strata do not lend themselves to an uncased construction technique due to stability concerns, the owner may specify the use and limits of the temporary casing.



subsurface geotechnical conditions, shall also be provided for the proposed slurry.

The submittal shall include a detailed plan for quality control of the selected slurry, including tests to be performed, test methods to be used, and minimum and/or maximum property requirements which must be met to ensure that the slurry functions as intended, considering the anticipated subsurface conditions and shaft construction methods, in accordance with the slurry manufacturer's recommendations and these Specifications. As a minimum, the slurry quality control plan shall include the following tests:

<b>Property</b>	<b>Test Method</b>
Density	Mud Weight (Density), API 13B-1, Section 1
Viscosity	Marsh Funnel and Cup, API 13B-1, Section 2.2
pH	Glass Electrode, pH Meter, or pH Paper
Sand Content	Sand, API 13B-1, Section 5

- Reinforcing steel shop drawings, details of reinforcement placement including type and location of all splices, reinforcement cage support and centralization methods, *type and location of all spacers, crosshole sonic logging tubes and other instrumentation, and procedures for lifting and setting the reinforcement cage.*

- When casings are proposed or required, casing dimensions and detailed procedures for permanent casing installation, temporary casing installation and removal, and methods of advancing the casing, along with the means to be utilized for excavating the casing, of casing or limiting the amount of excavation prior to the introduction of excavation prior to the introduction



casing and surrounding soil, if permanent casing is specified.

- *Details of any required load tests including equipment, instrumentation, procedures, calibration data for test equipment, calculations and drawings.*
- *Details and procedures for protecting existing structures, utilities, roadways and other facilities during drilled shaft installation.*
- *Other information required by the Plans or specified herein.*

The Engineer will evaluate the Drilled Shaft Installation Plan for conformance with the Contract Plans and Specifications within ten working days after receipt of the submission. At the option of the Owner, a Shaft Installation Plan Submittal Meeting may be scheduled following review of the Contractor's initial submittal of the Plan. Those attending the Shaft Installation Plan Submittal Meeting, if held, shall include the following:

- The superintendent, on-site supervisors, and other Contractor personnel involved in the preparation and execution of the Drilled Shaft Installation Plan.
- The Project Engineer and Owner's personnel involved with the structural, geotechnical, and construction review of the Drilled Shaft Installation Plan together with Owner's personnel who will provide inspection and oversight during the drilled shaft construction phase of project.

*The Contractor shall submit any significant updates or modifications to the Drilled Shaft Installation Plan whenever such updates or modifications are proposed to the Engineer. The Engineer will evaluate the new information for conformance with the Contract Plans and Specifications within ten working days after receipt of the submission.*

### X.2.3. Slurry Technical Assistance

If slurry is used to construct the drilled shafts, the Contractor shall provide, or arrange for, technical assistance from the slurry manufacturer as specified in Subsection X.4.3.4.1 of this Specification. The Contractor shall submit four copies of the following to the Engineer:

- The name and current phone number of the slurry manufacturer's technical representative assigned to the project.
- The name(s) of the Contractor's personnel assigned to the project and trained by the slurry manufacturer's technical representative in the proper use of the slurry. The submittal shall include a signed training certification letter from the slurry manufacturer for each individual, including the date of the training.

### X.2.4 Approvals

Work shall not begin until all the required submittals have been accepted in writing by the Engineer. All procedural acceptances given by the Engineer will be subject to trial in the field and shall not relieve the Contractor of the responsibility to satisfactorily complete the work.

### X.2.5 Drilled Shaft Preconstruction Conference

A shaft preconstruction conference shall be held at least five working days prior to the Contractor beginning any shaft construction work at the site to discuss investigative boring information, construction procedures, personnel, and equipment to be used, and other elements of the accepted Shaft Installation Plan as specified in Subsection X.2.2 of this Specification. If slurry is used to construct the shafts, the frequency of scheduled site visits to the project site by the slurry manufacturer's representative will be discussed. Those attending shall include:

Meetings may need to be held in order to obtain agreement on the shaft submittal, but the shaft conference should only be held after approval.

- The superintendent, on site supervisors, and other key personnel identified by the Contractor as being in charge of excavating the shaft, placing the casing and slurry as applicable, placing the steel reinforcing bars, and placing the concrete. If slurry is used to construct the shafts, the slurry manufacturer's representative and a Contractor's employee trained in the use of the slurry, as identified to the Engineer in accordance with Subsection X.4.3.4.1 of this Specification, shall also attend.
- The Project Engineer, key inspection personnel, and appropriate representatives of the Owner.

If the Contractor's key personnel change, or if the Contractor proposes a significant revision of the approved Drilled Shaft Installation Plan, an additional conference may be held at the request of the Engineer before any additional shaft construction operations are performed.

#### X.2.6 Logs of Shaft Construction

*The Contractor's Quality Control staff shall prepare inspection logs documenting each shaft construction activity, including casing installation, excavation, shaft bottom inspection, reinforcement installation and concrete placement. The logs shall fully document the work performed with frequent reference to the date, time and casing/excavation elevation. In addition, the Contractor shall prepare and submit the logs documenting any subsurface investigation borings or rock core holes performed for the Contract at drilled shaft foundation locations.*

*Complete and detailed shaft construction records are particularly important since these records are used to confirm compliance with the design and specification requirements, are often used for determination of pay quantities and, most importantly, they provide an initial means for identify potential defects in the shaft, as well as their cause and approximate location.*

*It is generally preferable that the Engineer or other representative of the Owner be given responsibility for performing shaft construction inspection. In such cases, the requirements for logging shaft construction may be omitted from the Specification. However, for design-build projects it is often required that drilled shaft inspection be performed by an independent QC entity engaged by the Contractor. In such cases, the specification provisions included herein would be applicable.*

*Records for temporary and permanent casing shall include at least the following information: identification number and location of the shaft; diameter and wall thickness of the casing; dimensions of any casing reinforcement; top and bottom elevations of the casing; method and equipment used for casing installation; any problems encountered during casing installation; and the name of the inspector.*

The shaft excavation log shall contain at least the following information: If the Contractor is given the responsibility for logging shaft identification number, location and surface elevation of the shaft; construction operations, the Specifications should include a copy of description and approximate top and bottom elevation of each soil or the forms to be used. Many Owners have standard forms for their rock material encountered; seepage or groundwater conditions; type projects. Sample inspection forms are also available from the FHWA and dimensions of tools and equipment used, and any changes to the (FHWA, 2002) and are presented in Appendix F. tools and equipment; type of drilling fluid used, if any, and the results of slurry tests; any problems encountered; elevation of any changes in the shaft diameter; method used for bottom cleaning; final bottom elevation of the shaft; and the name of the inspector and the date, time and name of any changes in the inspector

Concrete placement records shall include at least the following information: concrete mix used; time of start and end of concrete placement; volume and start/end time for each truck load placed; concrete test results; concrete surface elevation and corresponding tremie tip elevation periodically during concrete placement; concrete yield curve (volume versus concrete elevation, actual and theoretical); and the name of the inspector.

The logs for each shaft construction activity shall be submitted to the Engineer within 24 hours of the completion of that activity. A full set of shaft inspection logs for an individual drilled shaft shall be submitted to the Engineer within 48 hours of the completion of concrete placement at the shaft.

### X.3 MATERIALS

#### X.3.1 Concrete

Concrete used in the construction of drilled shafts shall be Class xxxxx conforming to Section X. The concrete slump shall be as follows:

Dry placement methods:	5 - 7 in.
Casing removal methods:	8 - 10 in.
Tremie placement methods:	8 - 10 in.

Each Owner will likely have their own concrete mix designs for drilled shaft applications based on local practice, weather conditions, aggregates, etc. Desirable properties for a concrete mix used for drilled shaft applications are: fluidity, compaction, resistance to segregation, limited bleed water, controlled heat of hydration, controlled set time, and minimum required strength.

Slump loss to less than four inches shall not be permitted during the period equal to the anticipated pour period plus two hours. Slump life may be extended through the use of retarders and mid-range water reducers.

To achieve maximum workability, the following mix characteristics are recommended:

- A maximum course aggregate size of 3/8" in wet hole pours or shafts with dense reinforcing configurations.
- Use of rounded in lieu of crushed aggregates.
- Use of fly ash as a cement replacement and as a fluidifier. Use of fly ash as a cement replacement can also facilitate meeting the heat of hydration requirements provided in Section X.4.1.

In cases where the reinforcing steel clear openings are restricted by density of steel (where the clear space between verticals or spirals/hoops is less than 10 times the aggregate size as discussed in Article CX.3.2) it is suggested that slumps of 8" - 10" be used even in dry placement methods.

### X.3.2 Reinforcing Steel

Reinforcing steel used in the construction of *drilled* shafts shall conform to AASHTO Materials Specification M31.

*When necessary*, vertical bars shall be bundled in order to maximize clear space between vertical reinforcement bars. Rolled hoops or bundled spirals shall be used in order to maximize the clear space between horizontal reinforcement.

Reinforcing steel cages for drilled shafts with varying shaft and socket diameters shall be designed with a single, uniform diameter.

Current practice regarding minimum clear space between reinforcement elements is to have clear distance between parallel longitudinal and parallel transverse reinforcing bars not be less than five times the maximum aggregate size or 5.0 in., whichever is greater, per Article 5.13.4.5.2 of the AASHTO LRFD Bridge Design Specifications. Recent research has indicated that proper flow of concrete through the cage cannot be assured with less clear space than required to provide a minimum space equal to or greater than 10 times the maximum aggregate size.

Reinforcing steel for shafts poured inside temporary casings should

not have hooks to the outside.

*For projects where the tip elevation of the drilled shafts depends on a minimum penetration into a bearing stratum, the length of the drilled shaft and the corresponding length of the reinforcing cage cannot be determined until the top of the bearing stratum is identified during shaft excavation. To avoid delay in the fabrication of the reinforcing cage in such cases, and the resulting delay in the completion of shaft construction, a provision can be included in the specifications requiring extension of at least one-half of the longitudinal bars, as well as all of the spiral or hoop steel once the final length of the shaft is determined. The increased length in the drilled shaft and shaft reinforcement can be based on the increased quantities for these work items. However, payment is not made for additional reinforcement if the shaft is inadvertently overexcavated to a depth greater than shown on the Plans or required by the Engineer.*

### X.3.3 Casings

All permanent structural casing shall be of steel conforming to ASTM A 36 or ASTM 252 Gr 2 unless specified otherwise in the Plans. All splicing of permanent structural casing shall be in accordance with Section 6.13.3 of the LRFD Bridge Design Specifications.

*The diameter of permanent casing shall be as shown on the Plans, unless a larger diameter casing is approved by the Engineer. When a larger size permanent casing is approved by the Engineer, no additional payment will be made for the increased weight of casing steel, or the increased quantity of drilled shaft excavation and concrete.*

All permanent casing shall be of ample strength to resist damage and deformation from transportation and handling, installation stresses, and all pressures and forces acting on the casing. For permanent nonstructural casing, corrugated casing may be used.

Where the minimum thickness of the casing is specified in the Plans, it is *In cases where seismic design governs, the Engineer may need to re-*



specified to satisfy structural design requirements only. The Contractor shall increase the casing thickness from the minimum specified thickness, as necessary, to satisfy the construction installation requirements.

*evaluate the foundation performance with the added stiffness of the casing with wall thickness greater than that shown on the Plans.*

All temporary casing shall be a smooth wall structure steel, except where corrugated metal pipe is shown in the Plans as an acceptable alternative material. All temporary casing shall be of ample strength to resist damage and deformation from transportation and handling, installation and extraction stresses, and all pressures and forces acting on the casing. The casing shall be capable of being removed without deforming and causing damage to the completed shaft, and without disturbing the surrounding soil.

Temporary casing is defined as casing installed to facilitate shaft construction only, is not designed as part of the shaft structure, and is completely removed after shaft construction is complete, unless otherwise shown in the Plans or approved by the Engineer. *Examples of temporary casing that may be required to be left in place include casing for drilled shaft installed through a body of water or through very soft soils that may not provide adequate lateral support for the wet concrete.*

Where seismic design requires that the shaft be constructed to the diameters indicated in the Drawings, the Engineer *should* specify that telescoping casing will not be allowed.

The outside diameter of temporary casing shall not be less than the specified diameter of the shaft.

In cases where seismic design governs, the inside diameter of the temporary casing shall not be greater than the specified diameter of the shaft plus six inches, unless otherwise specified on the Plans or approved by the Engineer.

All casing shall be watertight and clean prior to placement in the excavation.

*Temporary casing shall be completely removed, unless otherwise shown on the Plans or approved by the Engineer.*

#### X.3.4. Mineral Slurry

Mineral Slurry shall be used in conformance with the quality control plan specified in Subsection X.2.2.

Unit weights stated are exclusive of weighting agents which may be proposed by the Contractor with the agreement of the slurry manufacturer's representative.

Mineral slurry shall conform to the following requirements:

Some slurry systems incorporate a weighting agent when utilizing salt water in slurry. This may add up to 5 pcf to the unit weight.

When it is necessary to use a mineral slurry in salt water applications, it is recommended that attapulgite or sepiolite be used in lieu of bentonite. (See Section 7.3.1 of this Manual.)

Property	Test	Requirement
Density (pcf)	Mud Weight (Density) API 13B-1, Section 1	64.3* to 72*
Viscosity (seconds/quart)	Marsh Funnel and Cup API 13b-1, Section 2.2	28 to 50
pH	Glass Electrode, pH Meter, or pH Paper	8 to 11
Sand Content (percent) immediately prior to placing concrete	API 13B-1, Section 5	4.0 max

\* When approved by the Engineer, slurry may be used in salt water, and the allowable densities may be increased up to 2 pcf. Slurry temperature shall be at least 40°F when tested.

### X.3.5. Polymer Slurry

Polymer slurries, either natural or synthetic, shall be used in conformance with the manufacturer's recommendations, and shall conform to the quality control plan specified in Subsection X.2.2 of this Specification. The polymer slurry shall conform to the following requirements:

Property	Test	Requirement
Density (pcf)	Mud Weight (Density) API 13B-1, Section 1	64* pcf max.
Viscosity (seconds/quart)	Marsh Funnel and Cup API 13b-1, Section 2.2	32 to 135
pH	Glass Electrode, pH Meter, or pH Paper	8 to 11.5
Sand Content (percent) immediately prior to placing concrete	API 13B-1, Section 5	1.0 max**

The range of properties specified in the table is typical for many of the polymer slurries made from anionic polyacrylamides, or PAMs, on the market at the present time (2009). However, other varieties of polymer products are available. Accordingly, adjustments may be necessary and appropriate based on recommendations provided by the polymer supplier or manufacturer, taking into account new products and job-specific conditions. For example, some of the proprietary polymers now on the market operate optimally at Marsh funnel viscosities up to 150.

- \* When approved by the Engineer, polymer slurry may be used in salt water, and the allowable densities may be increased up to 2 pcf.
- \*\* The sand content of polymer slurry prior to final cleaning and immediately prior to placing concrete shall be less than or equal to 1.0 percent, in accordance with American Petroleum Institute API 13B-1, Section 5.

Slurry temperature shall be at least 40°F when tested.

### X.3.6. Water Slurry

Water may be used as slurry when casing is used for the entire length of the drilled hole, provided that the method of drilled shaft installation maintains stability at the bottom of the shaft excavation. A water slurry is water which is maintained as clean as possible during its use.

Water slurry shall conform to the following requirements:

<b>Property</b>	<b>Test</b>	<b>Requirement</b>
Density (pcf)	Mud Weight (Density) API 13B-1, Section 1	64 pcf max.
Sand Content (percent)	Sand API 13B-1, Section 5	1.0 max.

#### X.3.7 Access Tubes for Crosshole Sonic Log Testing

Access tubes for crosshole sonic log testing shall be steel pipe of 0.145 inches minimum wall thickness and at least 1-1/2 inch inside diameter. *PVC has been used for crosshole sonic logging (CSL) access tubes, but PVC tubing has a greater likelihood of debonding from the concrete, and associated influence on the CSL test results. PVC tubing also is more prone to damage during lifting and setting of the reinforcement cage. Accordingly, steel pipe is the preferred material for CSL access tubes.*

The access tubes shall have a round, regular inside diameter free of defects and obstructions, including all pipe joints, in order to permit the free, unobstructed passage of 1.3 inch maximum diameter source and receiver probes used for the crosshole sonic log tests. The access tubes shall be watertight, free from corrosion, and with clean internal and external faces to ensure good bond between the concrete and the access tubes. The access tubes shall be fitted with watertight threaded caps on the bottom and the top.

#### X.3.8 Grout

Grout for filling the access tubes at the completion of the crosshole sonic log tests shall be a neat cement grout with a minimum water/cement ratio of 0.45.

## X.4 CONSTRUCTION

### X.4.1 Drilled Shaft Excavation

*Drilled* shafts shall be excavated to the required depth as shown in the Plans or as directed by the Engineer. Once the excavation operation has been started, the excavation shall be conducted in a continuous operation until the excavation of the shaft is completed, except for pauses and stops as noted, using approved equipment capable of excavating through the type of material expected. Pauses during this excavation operation, except for casing splicing and removal of obstructions, will not be allowed. The Contractor shall provide temporary casing at the site in sufficient quantities to meet the needs of the anticipated construction method.

Pauses, defined as interruptions of the excavation operation, will be allowed only for casing splicing and removal of obstructions. *Drilled* shaft excavation operation interruptions not conforming to this definition shall be considered stops.

If the *drilled* shaft excavation is not complete at the end of the shift or series of continuous shifts, the *drilled* shaft excavation operation may be stopped, provided the Contractor, before the end of the work day, protects the shaft as indicated in Subsection X.4.2 of this Specification.

If slurry is present in the shaft excavation, the Contractor shall conform to the requirements of Subsection X.4.7.2 of this Specification regarding the maintenance of the minimum level of drilling slurry throughout the stoppage of the shaft excavation operation, and shall recondition the slurry to the required slurry properties in accordance with Section X.3 of this Specification prior to recommencing shaft excavation operations.

*The excavation and drilling equipment shall have adequate capacity, including power, torque and down thrust to excavate a hole of both the drilled shafts based on a) additional subsurface information obtained*

*The equipment and procedures used for drilled shaft excavation should be consistent with design assumptions regarding load transfer from the drilled shaft to the surrounding ground. For example, pre-drilling or the use of permanent non-structural casing within the bearing stratum that may result in reduced side resistance may not be appropriate for drilled shafts that rely on side resistance unless the influence of these procedures has been addressed by the Engineer in the determination of shaft penetration requirements.*

maximum diameter and to a depth of 20 feet, or 20 percent, beyond the maximum shaft length shown on the Plans, whichever is greater.

from exploratory borings performed during the construction contract, b) the results of the drilled shaft load test program, and/or c) the ground conditions identified during the drilled shaft excavation operations.

Blasting will only be permitted if specifically stated on the Plans or authorized in writing by the Engineer.

Sidewall overreaming shall be performed when the time for shaft excavation exceeds — hours (measured from the beginning of excavation below the casing when casing is used) before the start of concrete placement. Sidewall overreaming shall also be performed when the sidewall of the hole is determined by the Engineer to have softened due to the excavation methods, swelled due to delays in the start of concrete placement, or degraded because of slurry cake buildup. Overreaming thickness shall be a minimum of 1/2-inch and a maximum of 3 inches. Overreaming may be accomplished with a grooving tool, overreaming bucket, or other equipment approved by the Engineer. If overreaming is required as a result of the excavation time exceeding the time limit specified herein, or as a result of excavation methods not in compliance with the approved Drilled Shaft Installation Plan, the Contractor shall bear the costs associated with both sidewall overreaming and additional drilled shaft concrete related to overreaming.

Excavation to the foundation cap elevation shall be completed before drilled shaft construction begins, unless otherwise noted in the Contract Documents or approved by the Engineer. Any disturbance to the foundation cap area caused by shaft installation shall be repaired by the Contractor prior to placing the cap concrete.

When drilled shafts are to be installed in conjunction with embankment construction, the Contractor shall construct drilled shafts after placement of the embankment fill unless otherwise shown on the Contract Documents or approved by the Engineer. Drilled shafts installed prior to the completion of the embankment fill shall not be capped until the fill has been placed to the bottom of cap level.

A limit of 36 hours is often specified as the maximum time allowed for exposure of the drilled shaft excavation prior to the start of concrete placement. However, the actual time limit specified should be based on engineering judgment, considering the materials anticipated to be encountered and local practice. For materials which are resistant to degradation when exposed, such as cemented soils and durable rock, it may not be necessary to include a time limit in the Specifications.

Generally, embankment fill should be placed prior to installation of the drilled shafts to facilitate placement and compaction of the embankment fill, and to avoid potential damage to the drilled shafts that might occur if fill were to be placed and compacted near and between the drilled shafts. Installation of embankment fill and preloading of the underlying soils prior to installation of the drilled

*shafts may also reduce downdrag loads and lateral loads on the drilled shafts.*

#### X.4.2 Drilled Shaft Excavation Protection

*Drilled* shaft excavations shall not be left open overnight unless cased full depth or otherwise protected against sidewall instability. An open excavation is defined as a *drilled* shaft that has not been filled with concrete, or temporarily backfilled with a material approved by the Engineer in accordance with Subsection X.2.2 of this Specification or protected in accordance with Subsection X.4.3. The use of slurry to protect a *drilled* shaft during a drilling stoppage or overnight shutdown may be approved by the Engineer.

Casing of drilled shafts in stable rock formations during stoppages is not required, *unless shown on the Plans or specified herein.*

#### X.4.3 Drilled Shaft Excavation Protection Methods

The Contractor bears full responsibility for selection and execution of the method(s) of stabilizing and maintaining the *drilled* shaft excavation. The walls and bottom of the *drilled* shaft excavation shall be protected so that side wall caving and bottom heave are prevented from occurring, and so that the soil adjacent to the *drilled* shaft is not disturbed. The Contractor may excavate the *drilled* shaft without excavation protection provided *the Contractor* can demonstrate that the soil/rock is stable and above the water table and zones of seepage. Acceptable protection methods include the use of casing, drilling slurry, or both.

##### X.4.3.1 Temporary Casing Construction Method

In stable soils, the Contractor shall conduct casing installation and removal operations and *drilled* shaft excavation operations such that the adjacent soil outside the casing and *drilled* shaft excavation for the full height of the *drilled* shaft is not disturbed. Disturbed soil is defined as soil whose geotechnical properties have been changed from those of the

Project specification requirements may dictate that specific *drilled* shaft excavation protection methods should be used. For example, the contract may require that permanent casing be used if very soft soils are present that will not support the weight of the wet concrete when the casing is extracted, or if the foundations for an immediately adjacent structure are present and must be protected from movement.

*Temporary casing also includes surface (shallow) casing that is used to prevent sloughing and raveling of material into the drilled shaft excavation from the top of the hole. When extended a sufficient height above the ground surface, this surface casing can also serve as a part of the Contractor's safety measures to protect personnel from falling*

original in-situ soil, and whose altered condition adversely affects the performance of the *drilled* shaft foundation.

If the Contractor is utilizing casing that is adequately sealed into competent soils such that water cannot enter the excavation, the Contractor may, with the Engineer's approval, continue excavation in soils below the water table provided the water level within the casing does not rise or exhibit flow.

As the temporary casing is withdrawn, a sufficient head of fluid concrete must be maintained to ensure that water or slurry outside the temporary casing will not breach the column of freshly placed concrete.

Casing extraction shall be at a slow, uniform rate with the pull in line with the shaft axis. Excessive rotation of the casing shall be avoided to limit deformation of the reinforcing steel cage.

The Contractor shall remove all temporary casings from the excavation as concrete placement is completed, unless permission has been received from the Engineer to leave specified temporary casings in place.

#### X.4.3.2 Permanent Casing Construction Method

When permanent casing is specified, excavation shall conform to the specified outside diameter of the *drilled* shaft. After the casing has been filled with concrete, all void space occurring between the casing and *drilled* shaft excavation shall be filled with a material which approximates the geotechnical properties of the in-situ soils, in accordance with the *Drilled* Shaft Installation Plan specified in subsection X.2.2 of this Specification and as approved by the Engineer.

*into the drilled shaft excavation.*

Movement of the casing by rotation, exerting downward pressure, and tapping to facilitate extraction, or extraction with a vibratory hammer is acceptable.

*When temporary casing is placed in a predrilled hole there is a potential for loose material to be trapped in the annular void outside the casing. Loose material can also become trapped in the annular space between temporary and permanent casings. The presence of this loose material could cause defects at the perimeter of the completed shaft during extraction of the temporary casing as a result of material mixing with the concrete. Attention must be given to these issues when developing the specific drilled shaft installation procedures. In addition, a drilled shaft integrity testing program should be considered to assess the structural integrity of the completed drilled shafts.*

For reasons outlined in Article C X.2.2, the backfill of accidental over-excavation outside the casing may require the use of materials which closely approximate the lateral response of the native soils.

In other cases the Engineer may require that foundation materials be sealed against evaporation or water introduction. In those cases the Engineer may require that any annular space around a permanent casing be filled with structural grout.



Tops of permanent casings for the *drilled* shafts shall be removed to the top of the *drilled* shaft or finished groundline, whichever is lower, unless the top of permanent casing is shown in the Plans at a different elevation. For those *drilled* shafts constructed within a permanent body of water, tops of permanent casings for *drilled* shafts shall be removed to the low water elevation, unless otherwise shown on the Plans or directed otherwise by the Engineer.

*Unless shown otherwise on the Plans, casing used for forming shafts installed through a body of water shall not be removed.*

*Drilled shafts constructed through a body of water will require the use of the casing as a form for the shaft concrete. In such cases, specifications often include provisions for removal of the top of the casing to or below low water level after the concrete reaches a specified minimum strength. Some owner's standard specifications also allow removal of the portion of the casing below water level. However, removal of the lower section of casing risks damage to the concrete and exposes any surface defects to potentially deleterious effects or accelerated corrosion in water. Often such defects are difficult to identify, or may not be suitably repaired or inspected under water. Based on these considerations, casing should not be removed below water level unless this is required for compliance with an environmental or other regulatory requirement, and precautions are taken to maintain the structural integrity of the concrete.*

#### X.4.3.3 Alternative Casing Methods

*When approved by the Engineer, installation of casing using rotating or oscillating methods will be permitted. Use of this alternative casing method shall be in accordance with the equipment and procedures shown in the approved Drilled Shaft Installation Plan, and shall comply with all other requirements specified herein.*

*Drilled* shaft casing shall be equipped with cutting teeth or a cutting shoe and installed by either rotating or oscillating the casing.

This alternative may be specified if vibratory placement or extraction of casing is not permitted.

Soils consisting of gravel and cobble mixtures, or matrix supported boulders where the matrix is loose and granular, tend to be susceptible to caving and sloughing, and usually require casing to stabilize the *drilled* shaft side walls. These materials also make vibratory casing installation very difficult and risky for both the *Owner* and the Contractor. In such cases, the installation of temporary and/or permanent casing by either a rotating or an oscillating method may be required.

#### X.4.3.4 Slurry

The Contractor shall use slurry in accordance with Subsection X.3 of this Specification to maintain a stable excavation during excavation and concrete placement operations once water begins to enter the *drilled* shaft excavation and remain present

Many situations will require the Contractor to utilize both slurry and casing techniques in the same hole.

The Contractor shall use slurry to maintain stability during *drilled* shaft excavation and concrete placement operations in the event *that* water begins to enter the *drilled* shaft excavation at a rate of greater than twelve inches per hour, or if the Contractor is not able to restrict the amount of water in the *drilled* shaft to less than three inches prior to concrete *placement*, or to equilibrate water pressure on the sides and base of the *drilled* shaft excavation when groundwater is encountered or anticipated based on the available subsurface data.

##### X.4.3.4.1 Slurry Technical Assistance

If slurry is used, the manufacturer's representative, as identified to the Engineer in accordance with Subsection X.2.3 of this Specification, shall:

- provide technical assistance for the use of the slurry,
- shall be at the site prior to introduction of the slurry into a drilled hole, and
- shall remain at the site during the construction and completion of a minimum of one *drilled* shaft to adjust the slurry mix to the specific site conditions.

After the manufacturer's representative is no longer present at the site, the Contractor's employee trained in the use of the slurry, as identified to the Engineer in accordance with Subsection X.2.3 of this Specification, shall be present at the site throughout the remainder of

shaft slurry operations for this project to perform the duties specified above.

#### X.4.3.4.2 Minimum Level of Slurry in the Excavation

When slurry is used to maintain a stable excavation, the slurry level in the excavation shall be maintained to obtain hydrostatic equilibrium throughout the construction operation at a height required to provide and maintain a stable hole, but not less than 5 feet above the water table *or surface of surrounding water body if at an offshore location.*

The Contractor shall provide casing, or other means, as necessary to meet these requirements.

The slurry level shall be maintained above all unstable zones a sufficient distance to prevent bottom heave, caving or sloughing of those zones.

Throughout all stops in *drilled* shaft excavation operations, the Contractor shall monitor and maintain the slurry level in the excavation the greater of the following elevations:

- no lower than the water level elevation outside the *drilled* shaft,
- elevation as required to provide and maintain a stable hole.

#### X.4.3.4.3 Cleaning Slurry

The Contractor shall clean, re-circulate, de-sand, or replace the slurry, as needed, in order to maintain the required slurry properties. Sand content will only be required to be within specified limits immediately prior to concrete placement

#### X.4.4 Obstructions

When obstructions are encountered, the Contractor shall notify the Engineer promptly. An obstruction is defined as a specific object *A focused effort should be made during the project design phase to determine if obstructions may be encountered during drilled shaft*

Recommended slurry levels are as follows:

- not less than five feet for mineral slurries,
- not less than ten feet for water slurries,
- not less than ten feet for polymer slurries, except when a lesser dimension is specifically recommended by the slurry manufacturer for the site conditions and construction methods.

*When drilling fluid is used to maintain the stability of the hole, such as in clean, granular soils, a positive hydrostatic pressure should be maintained within the drilled shaft excavation during any interruptions or stops in the drilled shaft excavation operation. Staff and pumping equipment should be provided to maintain the minimum fluid levels noted above during such periods.*

(including, but not limited to, boulders, logs, and man made objects) encountered during the *drilled* shaft excavation operation which prevents or hinders the advance of the *drilled* shaft excavation. When efforts to advance past the obstruction to the design *drilled* shaft tip elevation result in the rate of advance of the *drilled* shaft drilling equipment being significantly reduced relative to the rate of advance for the portion of the *drilled* shaft excavation in the geological unit that contains the obstruction, then the Contractor shall remove, bypass or break up the obstruction under the provisions of Subsection X.6.13 of this Specification. *Blasting will not be permitted unless approved in writing by the Engineer.*

*Drilling tools that are lost in the excavation will not be considered obstructions, and shall be promptly removed by the Contractor. All costs due to lost tool removal will be borne by the Contractor including, but not limited to, costs associated with the repair of hole degradation due to removal operations or an excessive time that the hole remains open.*

#### X.4.5 Protection of Existing Structures

The Contractor shall control operations to prevent damage to existing structures, utilities, *roadways and other facilities*. Preventative measures shall include, but are not limited to, selecting construction methods and procedures that will prevent excessive caving of the *drilled* shaft excavation, and monitoring and controlling the vibrations from the driving of casing or sheeting, drilling of the shaft, or from blasting, if permitted.

*excavation. Special notes should be included in the Plans to alert the Contractor of the type, approximate size range, and likely locations of obstructions. The presence of obstructions should also be documented in the geotechnical or foundation report for the project.*

If the *Owner* chooses to limit obstruction removal to “unknown obstructions” it places a heavy burden on the Foundation Report to accurately describe the obstructions which a contractor should anticipate.

This section will be used for site specific issues such as shallow foundations adjacent to drilled shaft work or vibration sensitive installations. The *Owner* may choose to specify casing installation in advance of excavation or may restrict the amount of vibration a contractor may use to install or remove casing or perform drilling operations.

*The specific monitoring requirements for structures impacted by drilled shaft construction should be assessed individually for each project. If monitoring is determined to be necessary, a preconstruction survey of existing facilities should be performed to establish baseline data, including ambient vibration levels and existing structure defects. When vibrations are to be monitored, it is preferable for the Owner or Engineer to engage the services of a professional vibrations consultant to monitor, record and report*

*vibration levels during drilled shaft construction. Alternatively, the Contract Documents can include provisions requiring the Contractor to engage a professional vibrations consultant for this monitoring program.*

#### X.4.6 Slurry Sampling and Testing

Mineral slurry and polymer slurry shall be mixed and thoroughly hydrated in slurry tanks, lined ponds, or storage areas. The Contractor shall draw sample sets from the slurry storage facility and test the samples for conformance with the appropriate specified material properties before beginning slurry placement in the drilled hole. Slurry shall conform to the quality control plan included in the *Drilled Shaft Installation Plan* in accordance with Subsection X.2.2 of this Specification and approved by the Engineer. A sample set shall be composed of samples taken at mid-height and within two feet of the bottom of the storage area.

The Contractor shall sample and test all slurry in the presence of the Engineer, unless otherwise *approved by the Engineer*. The date, time, names of the persons sampling and testing the slurry, and the results of the tests shall be recorded. A copy of the recorded slurry test results shall be submitted to the Engineer at the completion of each *drilled* shaft, and during construction of each *drilled* shaft when requested by the Engineer.

Sample sets of all slurry, composed of samples taken at mid-height and within two feet of the bottom of the *drilled* shaft, shall be taken and tested during drilling as necessary to verify the control of the properties of the slurry. As a minimum, sample sets of polymer slurry shall be taken and tested at least once every four hours after beginning its use during each shift.

Sample sets of all slurry, as specified, shall be taken and tested immediately prior to placing concrete.

*Lined ponds should generally not be permitted for mixing or storing slurry unless approved by the Engineer.*

The Contractor shall demonstrate to the satisfaction of the Engineer that stable conditions are being maintained. If the Engineer determines that stable conditions are not being maintained, the Contractor shall immediately take action to stabilize the shaft. The Contractor shall submit a revised *Drilled Shaft Installation Plan* which addresses the problem and prevents future instability. The Contractor shall not continue with *drilled* shaft construction until the damage which has already occurred is repaired in accordance with the Specifications, and until receiving the Engineer's approval of the revised *Drilled Shaft Installation Plan*.

#### X.4.7 Drilled Shaft Excavation Inspection

The Contractor shall use appropriate means such as a cleanout bucket, air lift or hydraulic pump to clean the bottom of the excavation of all *drilled* shafts. The base of the *drilled* shaft excavation shall be covered with not more than three inches of sediment or loose or disturbed material just prior to placing concrete in soil shafts or not more than one-half inch for 50 percent of the shaft area in rock sockets.

The excavated *drilled* shaft will be inspected and approved by the Engineer prior to proceeding with construction. The bottom of the excavated *drilled* shaft shall be sounded with an airlift pipe, a tape with a heavy weight attached to the end of the tape, a *borehole camera* with *visual sediment depth measurement gauge*, or other means acceptable to the Engineer to determine that the *drilled* shaft bottom meets the requirements in the Contract.

The amount of sediment left on the base of the *drilled* shaft can be determined by using a weighted tape and bouncing it on the bottom of the *drilled* shaft. If the weight strikes the bottom of the excavation with an immediate stop, the *drilled* shaft has little or no sediment. If the weight slows down and sinks to a stop, then excessive sediment exists.

*The depth of sediment determined with the use of a weighted tape is subject to interpretation, and use of a weighted tape is generally appropriate when a firm bottom can be achieved by the selected*

*excavation and bottom cleaning methods. If further confirmation or documentation of bottom cleanliness is desired, or if sediments are thicker than can be evaluated with the use of a weighted tape, consideration should be given to use of camera techniques for inspection of the drilled shaft bottom. Camera inspection methods should include means for visually measuring the thickness of loose sediments with a sediment depth gauge. Camera inspection equipment is currently available for use in slurry filled holes. If cleanliness of less than two inches of loose material is required, the inspection must utilize camera techniques that enable visual inspection.*

The cleanliness of the drilled shaft base is a requirement not only for end bearing considerations but also to ensure that an uncontaminated concrete pour is possible.

*Visual inspection by personnel in the hole should generally be avoided based on safety considerations. If entry is required, measures must be implemented to provide for the safety of the inspector.*

#### X.4.8. Assembly and Placement of Reinforcing Steel

*Prior to and during fabrication of the steel reinforcing cage, the reinforcing bars shall be supported off the ground surface, and shall be protected from contamination with mud and other deleterious materials.*

The reinforcing cage shall be rigidly braced to retain its configuration during handling and construction. Individual or loose bars will not be permitted. All (100%) intersections of vertical and horizontal bars must be tied. The Contractor shall show bracing and any extra reinforcing steel required for fabrication of the cage on the shop drawings.

The reinforcement shall be carefully positioned and securely fastened to provide the minimum clearances *specified or shown on the Plans*, and to ensure that no displacement of the reinforcing steel cage occurs during placement of the concrete.

*Splicing of the reinforcement cage during placement of the cage in the shaft excavation will not be permitted unless otherwise shown on the Plans or approved by the Engineer.*

*If the reinforcing cage is spliced during placement of the cage into the drilled shaft excavation, the splice details and location of the splices shall be in accordance with the Plans and the approved Drilled Shaft Installation Plan. In addition, the work shall be performed within the time limits specified in Subsection X.4.1.*

The steel reinforcing cage shall be securely held in position throughout the concrete placement operation. The reinforcing steel in the drilled shaft shall be tied and supported so that the location of the reinforcing steel will remain within allowable tolerance. Concrete spacers or other approved non-corrosive spacing devices shall be used at sufficient intervals (near the bottom, the top and at intervals not exceeding 10 feet vertically) to ensure concentric spacing for the entire cage length. The number of spacers required at each level will be one spacer for each foot of excavation diameter, with a minimum of four spacers at each level. The spacers shall be of adequate dimension to ensure an annular space between the outside of the reinforcing cage and the side of the excavation along the entire length of the drilled shaft as shown in the Plans. Acceptable feet made of plastic, or concrete (bottom supports) shall be provided to ensure that the bottom of the cage is maintained at the proper distance above the base of the excavation unless the cage is suspended from a fixed base during the concrete pour.

Bracing steel which constricts the interior of the reinforcing cage must be removed after lifting the cage if freefall concrete or wet tremie methods of concrete placement are to be used.

*The elevation of the top of the steel cage shall be checked before and after the concrete is placed. If the upward displacement of the rebar cage exceeds 2 inches, or if the downward displacement exceeds 6 inches, the drilled shaft will be considered defective. Corrections shall be made by the Contractor to the satisfaction of the Engineer. No*

Recommended concrete cover to reinforcing steel:

<u>Drilled Shaft Diameter</u>	<u>Minimum Concrete Cover</u>
Less than or equal to 3'-0"	3"
Greater than 3'-0" and less than 5'-0"	4"
5'-0" or larger	6"



*additional drilled shafts shall be constructed until the Contractor has modified the rebar cage support in a manner satisfactory to the Engineer.*

#### X.4.9 Concrete Placement, Curing and Protection

Concrete placement shall commence as soon as possible after completion of drilled shaft excavation by the Contractor and inspection by the Engineer. Immediately prior to commencing concrete placement, the *drilled* shaft excavation and the properties of the slurry (if used) shall conform to Subsection X.3 of this Specification. Concrete placement shall continue in one operation to the top of the *drilled* shaft, or as shown in the Plans.

If water is not present (a dry shaft), the concrete shall be deposited through the center of the reinforcement cage by a method which prevents segregation of aggregates. The concrete shall be placed such that the free-fall is vertical down the center of the *drilled* shaft without hitting the sides, the steel reinforcing bars, or the steel reinforcing bar cage bracing.

*Research has demonstrated that virtually unlimited free fall is acceptable if the concrete mix is cohesive and contains relatively small maximum-sized coarse aggregate. However, the height of free fall should be controlled to reduce the risk of the concrete impacting the reinforcing steel cage. The specified maximum height of free fall should consider the diameter of the shaft excavation and the diameter of the reinforcing cage. For very large-diameter shafts with large-diameter cages, where the danger of striking the cage is reduced, it may be permissible to permit free-fall to a height of as much as 80 ft, consistent with the maximum free fall evaluated in tests by Baker (1960). Free fall concrete can be guided to the center of the shaft with the use of a centering hopper.*

If water exists in amounts greater than three inches in depth or enters at a rate of more than twelve inches per hour then the *drilled* shaft excavation must be filled with slurry to at least the level specified in Subsection X.4.3.4.2 and concrete placed by tremie methods.

A practical definition of a dry shaft is when the amount of standing water in the base of the shaft prior to concreting is less than or equal to three inches, and water is entering the shaft at a rate of less than twelve inches per hour.

*The elapsed time for concrete placement shall not exceed the time limit defined in the approved Drilled Shaft Installation Plan and Standard Specification specify a time limit for concrete placement (e.g. demonstrated by a successful technique shaft or test shaft. The concrete placement time shall commence at the mixing of the concrete and extend allowing additional time if successfully demonstrated by testing of a*

through to the completion of placement of the concrete in the drilled shaft excavation, including removal of any temporary casing. For wet placement methods, the placement time shall start at the batching of the initial load of concrete to be placed in the shaft. Prior to concrete placement, the Contractor shall provide test results of both a trial mix and a slump loss test conducted by an approved testing laboratory using approved methods to demonstrate that the concrete meets this defined placement time limit. The concrete mix shall maintain a slump of 4 inches or greater over the defined placement time limit as demonstrated by trial mix and slump loss tests. The trial mix and slump loss tests shall be conducted at ambient temperatures appropriate for site conditions. Ambient air temperature at the time of concrete placement shall not be greater than the ambient temperature at the time of the concrete trial tests and slump loss tests.

Admixtures such as water reducers, plasticizers, and retarders shall not be used in the concrete mix unless permitted in the Contract Documents and detailed in the approved Drilled Shaft Installation Plan. All admixtures, when approved for use, shall be adjusted for the conditions encountered on the job so the concrete remains in a workable plastic state throughout the defined placement time limit.

Throughout the underwater concrete placement operation, the discharge end of the tube shall remain submerged in the concrete at least five feet and the tube shall always contain enough concrete to prevent water from entering. The concrete placement shall be continuous until the work is completed, resulting in a seamless, uniform shaft. If the concrete placement operation is interrupted, the Engineer may require the Contractor to prove by core drilling or other tests that the drilled shaft contains no voids or horizontal joints. If testing reveals voids or joints, the Contractor shall repair them or replace the drilled shaft at no expense to the Owner. Responsibility for coring and testing costs, and calculation of time extension, shall be in accordance with Subsection X.4.12 of this Specification.

trial mix. Deep, large diameter drilled shafts typically require a concrete placement time that greatly exceeds these commonly specified time limits.

The concrete must maintain the specified minimum 4-inch slump for the full placement period, which includes transportation of the concrete to the shaft location, placement of the concrete into the shaft, and removal of any temporary casing. This minimum slump is required to assure that the concrete remains sufficiently plastic to flow through the reinforcement cage and to fill areas vacated by the removal of temporary casing. The 4-inch slump value is the minimum at which adequate fluid pressures can be assumed to develop against the sides of the hole.

For longer concrete placement times, retarders and additives will likely be required to maintain the specified minimum concrete slump for the longer time period.

A greater penetration of the tremie pipe into the concrete is desirable to reduce the risk of inadvertently pulling the tremie out of the concrete. Consideration should be given to increasing the minimum tremie penetration to ten feet into the concrete, particularly for fluid mixes that will flow readily with the increased penetration.

Technique shafts provide an opportunity to assess concrete placement time, as well as concrete placement procedures.

Before placing any fresh concrete against concrete deposited in water or slurry (construction joint), the Contractor shall remove all scum, laitance, loose gravel and sediment on the surface of the concrete deposited in water or slurry, and chip off any high spots on the surface of the existing concrete that would prevent any steel reinforcing bar cage from being placed in the position required by the Plans.

The Contractor shall complete a concrete yield plot for each wet shaft poured by tremie methods. This yield plot will be submitted to the Owner within twenty four (24) hours of completion of the concrete pour

The Contractor shall not perform casing installation or drilled shaft excavation operations within a clear distance of three diameters of a newly poured drilled shaft within twenty (24) hours of the placement of concrete and only when the concrete has reached a minimum compressive strength of 1800 psi.

#### X.4.10 Tremies

When placing concrete underwater, the Contractor shall use a concrete pump or gravity tremie. A tremie shall have a hopper at the top that empties into a watertight tube at least eight inches in diameter. If a pump is used, a watertight tube shall be used with a minimum diameter of four inches. The discharge end of the tube on the tremie or concrete pump line shall include a device to seal out water while the tube is first filled with concrete. In lieu of a seal at the discharge end of the pipe, the Contractor may opt to place a "Pig" or "Rabbit" in the hopper prior to concrete placement which moves through the tremie when pushed by the concrete, forcing water or slurry from the tremie pipe.

*The hopper and tubes shall not contain aluminum parts that will have contact with the concrete. The inside and outside surfaces of the tubes shall be clean and smooth to allow both flow of concrete and the unimpeded withdrawal of the tube during concrete placement.*

In cases where it is possible to pour tremie placed drilled shafts to the ground surface the Contractor should consider placing concrete until a minimum of eighteen inches of concrete measured vertically has been expelled to eliminate contaminants in the top of the shaft pour. The height of this overpour should be evaluated at the beginning of each project.

Because of the nature of drilled shaft mix designs, it is unnecessary to vibrate the concrete. In addition, vibrating the concrete is undesirable since it may cause segregation of the aggregate.

*An alternative specification that should be considered requires a minimum tremie pipe inside diameter of 10 inches and a minimum pump line inside diameter of 5 inches. These larger diameters facilitate flow of concrete and reduce the risk of plugging of the pipe during concrete placement.*

A pig or rabbit is a flexible device which fills the entire cross section of the tremie tube and creates an impermeable separation between the concrete in the tremie and the slurry.

#### X.4.11 Drilled Shaft Construction Tolerances

Drilled shafts shall be constructed so that the center of the poured shaft at the top of the *drilled* shaft or mudline, whichever is lower, is within the following horizontal tolerances:

<u>Drilled Shaft Diameter</u>	<u>Tolerance</u>
Less than or equal to 2'-0"	3"
Greater than 2'-0" and less than 5'-0"	4"
5'-0" or larger	6"

Drilled shafts in soil shall be within 1.5 percent of plumb. Drilled shafts in rock shall be within 2.0 percent of plumb. Plumbness will be measured from the top of poured *drilled* shaft elevation or mudline, whichever is lower.

During drilling or excavation of the *drilled* shaft, the Contractor shall make frequent checks on the plumbness, alignment, and dimensions of the *drilled* shaft. Any deviation exceeding the allowable tolerances shall be corrected with a procedure approved by the Engineer.

Drilled shaft steel reinforcing bars shall be no higher than six inches above or three inches below the plan elevation.

*The reinforcing cage shall be concentric with the drilled shaft excavation within a tolerance of 1-1/2 inches.*

*The top elevation of the completed drilled shaft shall have a tolerance of plus one inch or minus three inches.*

*The diameter of the drilled shaft shall not be less than the diameter shown on the Plans.*

*Tolerances for casings shall be in accordance with American Pipe Institute tolerances applicable to regular steel pipe.*

*The top of shaft horizontal tolerance presented in this specification represents a practical bound that is considered achievable for all drilled shaft projects. Lower values can be considered if warranted by design requirements, but this may require special techniques and may result in higher costs.*

*In cases where it is not practical to determine the location of the top of the drilled shaft or shaft location at the mudline, such as at shafts for underwater footings, the top of the casing can be used for setting and checking the location of the shaft. For these situations, the foundation design should consider a greater offset tolerance at the top of the drilled shaft than the values specified.*

Drilled shaft excavations and completed drilled shafts not constructed within the required tolerances will be considered defective. The Contractor shall be responsible for correcting all defective drilled shafts to the satisfaction of the Engineer. Materials and work necessary, including engineering analysis and redesign, to complete corrections for out-of-tolerance drilled shafts shall be furnished without either cost to the Owner or an extension of the completion date of the project. Redesign drawings and computations submitted by the Contractor shall be signed by a registered Professional Engineer licensed in the State of \_\_\_\_\_.

When a completed drilled shaft excavation exceeds the specified tolerances, the Contractor should be required to propose, develop, and, after approval, implement corrective treatment. The Engineer should not direct the work. Typical corrective treatments include:

- (a) Overdrill the drilled shaft excavation to a larger diameter to permit accurate placement of the reinforcing steel cage with the required minimum concrete cover.
- (b) Increase the number and/or size of the steel reinforcement bars.
- (c) Drill out the green concrete and reform the hole.
- (d) Downgrade the resistance value for the drilled shaft.
- (e) Install one or more additional drilled shafts to replace or supplement the out-of-tolerance shaft.

*In addition, the Engineer can perform analyses to determine if the out-of-tolerance shaft can be accepted without corrective measures.*

#### X.4.12 Integrity Testing

Crosshole sonic log testing may be performed on all drilled shafts. The Contractor shall accommodate the crosshole sonic log testing by furnishing and installing access tubes in accordance with Subsection X.3.7 of this Specification.

Crosshole Sonic Logging (CSL) testing will be used as a regular inspection method for wet placement shafts using tremie concrete methods. Other Non Destructive Testing (NDT) methods available include Gamma-Gamma (GG) testing and Pulse Echo Testing. *Specifications have been included herein for CSL testing since CSL testing is a common method of non-destructive integrity testing for drilled shafts. See Chapter 20 of this Manual for a discussion of the details and procedures for other, less common methods for integrity testing.*

The Contractor shall install access tubes for crosshole sonic log testing in all drilled shafts, except as otherwise noted *herein*, to permit access for the crosshole sonic log test probes. If, in the opinion of the Engineer, the condition of the drilled shaft excavation permits drilled shaft construction in the dry, the Engineer may specify that the testing be omitted.

*The Contract Documents should note the extent of CSL testing for the Project and the organization (Contractor, Engineer, or Owner) responsible for performing CSL testing.*

For drilled shafts placed in the dry, CSL testing should only be used where visual inspection indicates that irregularities in concrete

placement may have occurred, and at all technique shafts and load test shafts.

The Contractor shall securely attach the access tubes to the interior of the reinforcement cage of the *drilled* shaft. One access tube shall be furnished and installed for each foot of *drilled* shaft diameter, rounded to the nearest whole number, *unless otherwise* shown in the Plans. A minimum of three tubes will be required. The access tubes shall be placed around the *drilled* shaft, inside the spiral or hoop reinforcement and three inches clear of the vertical reinforcement, at a uniform spacing measured along the circle passing through the centers of the access tubes. If these minimums cannot be met due to close spacing of the vertical reinforcement, then the access tubes shall be bundled with the vertical reinforcement.

If trimming the cage is required and access tubes for crosshole sonic log testing are attached to the cage, the Contractor shall either shift the access tubes up the cage, or cut the access tubes provided that the cut tube ends are adapted to receive the watertight cap as specified.

The access tubes shall be installed in straight alignment and as near to parallel to the vertical axis of the reinforcement cage as possible. The access tubes shall extend from the bottom of the *drilled* shaft to at least two feet above the top of the *drilled* shaft. Splice joints in the access tubes, if required to achieve full length access tubes, shall be watertight. The Contractor shall clear the access tubes of all debris and extraneous materials before installing the access tubes. Care shall be taken to prevent damaging the access tubes during reinforcement cage installation and concrete placement operations in the *drilled* shaft excavation.

The access tubes shall be filled with potable water before concrete placement, and the top watertight threaded caps shall be reinstalled.

Prior to performing any crosshole sonic log testing operations specified in this subsection, the Contractor shall remove the concrete at the top of

*It is desirable to place the CSL tubes separate from the vertical reinforcement since bundling the CSL tubes with the vertical reinforcing bars may risk voids or concrete laitance being trapped in the crevices between the CSL tubes and reinforcing bars that could potentially yield misleading CSL test results. If the CSL tubes are bundled with the vertical reinforcement, care needs to be taken to assure the concrete remains fluid throughout the concrete placement period.*

*If the reinforcing steel does not extend to the bottom of the drilled shaft, the CSL tubes should be extended to the drilled shaft bottom. In such cases, a sufficient number of reinforcing bars should be extended to the bottom of the drilled shaft excavation to secure the CSL tubes in position.*

the drilled shaft down to sound concrete.

The *Owner* will perform crosshole sonic log testing and analysis on all completed *drilled* shafts designated for testing by the Engineer. The *Owner* will require advance notice from the Contractor to schedule all crosshole sonic log testing. The Contractor shall give at least forty eight (48) hours notice to the Engineer of the time the concrete in each drilled shaft will be sufficiently cured to allow for crosshole sonic log testing.

The testing shall be performed after the *drilled* shaft concrete has cured at least ninety six (96) hours. Additional curing time prior to testing may be required if the *drilled* shaft concrete contains admixtures, such as set retarding admixture or water reducing admixture. The additional curing time prior to testing required under these circumstances shall not be grounds for additional compensation or extension of time to the Contractor. No subsequent construction shall be performed on the completed *drilled* shaft until the CSL tests are approved and the *drilled* shaft accepted by the Engineer.

After placing the *drilled* shaft concrete and before beginning the crosshole sonic log testing of a *drilled* shaft, the Contractor shall inspect the access tubes. Each access tube that the test probe cannot pass through shall be replaced, at the Contractor's expense, with a two inch diameter hole cored through the concrete for the entire length of the *drilled* shaft. Unless directed otherwise by the Engineer, cored holes shall be located approximately six inches inside the reinforcement and shall not damage the *drilled* shaft reinforcement. Descriptions of inclusions and voids in cored holes shall be logged and a copy of the log shall be submitted to the Engineer. Findings from cored holes shall be preserved, identified as to location, and made available for inspection by the Engineer.

The *Owner* may opt to require the Contractor to provide the Integrity Testing and provide the results to the *Owner* for its approval. For this option, the Specification should require the Contractor to engage a qualified testing consultant to perform the integrity testing, and include provisions defining the minimum qualifications of the integrity testing consultant and the individual(s) performing the tests. The Specifications also need to include requirements for performing the tests (including the tube pairs to be tested, and the depth/frequency of testing), and provisions for test reports including information and data plots to be presented in the report.

To reduce the risk of debonding the CSL tubes, consideration should be given to specify a maximum time for initial CSL testing after concrete placement. The Maximum time should consider the type of material used for the CSL tubes.

If a single tube is blocked, the Engineer may perform CSL testing on the remaining tubes. If no anomalies are noted, the Engineer may waive the requirement to provide the cored alternative hole.

The Engineer will determine final acceptance of each *drilled* shaft, based on the crosshole sonic log test results and analysis for the tested shafts and a review of the visual inspection reports for the subject *drilled* shaft, and will provide a response to the Contractor within three working days after receiving the test results and analysis submittal.

*In cases where a defect is suspected, but the potential impact of the defect is uncertain, the Engineer's response can note the need for additional time to perform engineering analyses for the shaft. Such analyses would consider the location and likely extent of the suspected defect. With such analyses it is possible that the drilled shaft may be determined to meet performance requirements and be acceptable even if the suspected defect is present.*

The Engineer will approve continuing with *drilled* shaft construction prior to approval and acceptance of the first shaft if the Engineer's observations of the construction of the first shaft are satisfactory, including, but not limited to, conformance to the *Drilled* Shaft Installation Plan as approved by the Engineer, and the Engineer's review of Contractor's daily reports and inspector's daily logs concerning excavation, steel reinforcing bar placement, and concrete placement.

*It is suggested that the first sentence of this AASHTO Specification provision be changed from "The Engineer will approve ..." to "The Engineer may approve ..."*

If the Engineer determines that the concrete placed under slurry for a given *drilled* shaft is structurally inadequate, that *drilled* shaft will be rejected. The placement of concrete under slurry shall be suspended until the Contractor submits to the Engineer written changes to the methods of *drilled* shaft construction needed to prevent future structurally inadequate *drilled* shafts, and receives the Engineer's written approval of the submittal.

*If the Engineer determines that additional investigation is necessary, or if the Contractor requests, the Engineer may direct that additional testing be performed at a drilled shaft. At the Engineer's request, the Contractor shall drill a corehole in any questionable quality drilled shaft (as determined from crosshole sonic log testing and analysis or by observation of the Engineer) to explore the drilled shaft condition. The number, locations, diameter and depth of the core holes and lengths of individual core runs shall be determined by the Engineer. Coring procedures shall minimize abrasion and erosion of the core samples, and shall avoid damage to the steel reinforcement. Descriptions of inclusions and voids in cored holes shall be logged and a copy of the log shall be submitted to the Engineer. Recovered core shall be preserved*



*in suitably labeled wood core boxes, identified as to location and depth, and made available for inspection by the Engineer. The Engineer may direct water pressure testing in the core holes, and/or unconfined compression testing and other laboratory testing on selected samples from the concrete core.*

If subsequent testing at a *drilled* shaft indicates the presence of a defect(s) in the *drilled* shaft, the testing costs and the delay costs resulting from the additional testing shall be borne by the Contractor. If this additional testing indicates that the *drilled* shaft has no defect, the testing costs and the delay costs resulting from the additional testing will be paid by the Owner, and, if the *drilled* shaft construction is on the critical path of the Contractor's schedule, a time extension equal to the delay created by the additional testing will be granted.

A defect is defined as a feature which will result in inadequate or unsafe performance under strength, service, and extreme event loads, or inadequate serviceability over the design life of the drilled shaft, in the opinion of the Engineer.

*It is suggested that the above definition of "defect" be replaced with the following: "A defect includes any void, discontinuity, deficient concrete strength, inclusion or crack within the drilled shaft concrete that, in the opinion of the Engineer, requires further investigation, whether or not it is subsequently determined to represent an inadequate or unsafe condition for the completed drilled shaft." This suggested revision is consistent with the approach discussed in Chapters 20 and 21 of this Reference Manual. This revision gives the responsibility for the cost of further investigation to the Contractor whenever shaft installation results in a defect in the shaft concrete.*

If a defect is discovered, it is recommended that three dimensional tomography be conducted to better define the extent of the defect.

For all *drilled* shafts determined to be unacceptable, the Contractor shall submit a plan for further investigation or remedial action to the Engineer for approval. All modifications to the dimensions of the *drilled* shafts, as shown in the Plans, required by the investigation and remedial action plan shall be supported by calculations and working drawings. All investigation and remedial correction procedures and designs shall be prepared by a registered Professional Engineer licensed in the State of \_\_\_\_\_, and submitted to the Engineer for approval. The Contractor shall not begin repair operations until receiving the Engineer's written approval of the investigation and remedial action plan.

Prior to beginning coring, the Contractor shall submit the method and equipment to be used to drill and remove cores from *drilled* shaft concrete to the Engineer, and shall not begin coring until it has received the Engineer's written approval. The coring method and equipment shall provide for complete core recovery and shall minimize abrasion and erosion of the core.

The recovery system most often used to ensure undamaged core recovery is the triple barrel system.

All access tubes and cored holes shall be dewatered and filled with grout after tests are completed and the *drilled* shaft is accepted. The access tubes and cored holes shall be filled using grout tubes that extend to the bottom of the tube or hole or into the grout already placed.

*When remediation of a drilled shaft may be necessary, the CSL tubes should be maintained for post-remediation testing, and not grouted until completion of the necessary remediation measures and final written acceptance of the drilled shaft by the Engineer.*

#### X.5 DRILLED SHAFT LOAD TESTS

*Test shafts shall be installed at the locations shown on the Plans unless otherwise directed or approved by the Engineer.*

*Two load test methods are approved by ASTM for use with drilled shafts. These include Static Load Tests (ASTM D 1143) and Force Pulse (Rapid) Testing (ASTM D 7383), as described below.*

*Test shafts shall be installed to the same dimensions, details and elevations shown on the Plans, and shall be installed using the same equipment and installation procedures proposed for installation of the foundation drilled shafts.*

*Another method commonly used for drilled shaft load tests includes the Bi-Directional Load Cell method. Currently, there are no established testing standards for this test method. Until such standards become available, it is suggested that the following specifications be used as a guide when using the Bi-Directional Load Cell test.*

*If the equipment or procedures are changed following the completion of load testing, the Contractor shall install additional load test shafts, and conduct additional load tests as directed by the Engineer at no additional cost to the Owner.*

*See Chapter 17 for further description and discussion of the above test methods.*

*All load testing shall be completed and the results evaluated by the Engineer before installing any production drilled shafts, unless otherwise authorized by the Engineer.*

##### *X5.1 Static Load Tests*

*Static load tests shall be performed in accordance with the procedures specified in ASTM D 1143. ASTM D 1143 and D 3689 describe the complete procedures for performing axial compression load tests and axial tensile load tests, respectively.*

### *X.5.2 Force Pulse (Rapid) Load Tests*

*Force pulse (rapid) load tests shall be performed in accordance with the procedures specified in ASTM D 7383.*

*ASTM D 7383 specifies two alternative procedures, including “Procedure A” where the compression force pulse is applied at the top of the drilled shaft using a combustion gas pressure, and “Procedure B” where the compression force pulse is applied by dropping a mass onto the cushioned top of the drilled shaft. Each of these methods estimates resistance along the drilled shaft by evaluating the dynamic response of the drilled shaft and the dynamic characteristics of the supporting ground.*

### *X.5.3 Bi-Directional Load Cell Testing (Interim Guide Specification)*

*The Contractor shall install load cells and load test instrumentation in accordance with the bi-directional load cell supplier recommendations, instructions, and procedure manual(s), as approved by the Engineer.*

*The bi-directional load cells shall be capable of expanding to not less than 6 inches while maintaining the applied test load.*

*The Contractor shall be responsible for coordinating with the load cell supplier to determine and/or verify all required equipment, materials, quantities, procedures, and all other applicable items necessary to complete the load testing shown on the Plans.*

*The Contractor shall furnish an acceptable pressurized gas source, a hydraulic pump, hydraulic lines, calibrated hydraulic gauge and other equipment and material necessary to perform the load tests. The Contractor shall furnish fresh, potable water from an approved source to form the hydraulic fluid used to pressurize the bi-directional load cells.*

*The Contractor shall furnish, install and monitor vibrating wire strain gauges as shown on the Plans and as directed by the Engineer. The strain gauges shall be placed in pairs on opposite sides of the*

*At present (2009) there are no ASTM standards for bi-directional load cell testing. Accordingly, until such standards are available, caution must be exercised in the planning, execution and interpretation of the results of load tests using this method. The guide specifications presented herein include interim specifications with suggested procedures for performing bi-directional load cell tests based on current general practice.*

*reinforcing cage at the elevations shown on the Plans, unless otherwise directed by the Engineer.*

*Two LVDT vibrating wire displacement gauges shall be attached to each load cell to monitor the expansion and contraction of the load cell. In addition, two LVDT gauges shall be mounted on an independent reference beam and set on opposite sides of the top of the test shaft to monitor axial shaft displacement.*

*Two telltale rods shall be set on the top of each load cell to monitor the displacement of the top of the load cell. The telltale shall consist of a 3/8-inch diameter stainless steel rod, greased for reducing friction and corrosion, and placed inside a constant 3/4-inch diameter pipe. Individual sections of telltales shall be joint coupled flush so that each rod is of uniform diameter throughout its length.*

*A portable computer and electronic logging equipment shall be furnished to simultaneously monitor all instrumentation at time intervals designated by the Engineer.*

*The load cells, piping and other attachments shall be assembled and made ready for installation in accordance with the requirements of the bi-directional load cell supplier, unless otherwise specified herein or directed by the Engineer. The following guidelines shall be followed.*

- *Steel top and bottom bearing plates shall be welded to the load cells. Holes shall be provided through the bearing plates, as appropriate, to facilitate placement of tremie concrete.*
- *The upper surface of the bottom steel bearing plate shall be coated with grease prior to installation into the shaft, to prevent concrete bonding with the bottom plate.*
- *The load cells and plate assembly shall be attached to the reinforcement cage. All hydraulic hoses, telltale casing, slip joints, etc. shall be securely fastened to the rebar cage. Prior to installation into the drilled shaft excavation, the top of any piping should be protected to keep dirt, concrete or other deleterious materials from entering the piping.*

- *The Contractor shall limit the deflection of the cage to a maximum of 2 feet between pick points while lifting the cage from the horizontal position to vertical. Provide additional support, bracing, strong backs, etc. to maintain the deflection within the specified tolerance.*

*For each load test, the load shall be placed on the drilled shaft in increments of five percent of the estimated maximum test load shown on the Plans, or until the nominal resistance load (as indicated by the instruments) is approached, or to the maximum capacity of the load cell, whichever occurs first. Unless the maximum capacity of the load cell has been reached, increments of 2.5 percent of the estimated maximum test load shall then be applied until the limiting load is attained, or the drilled shaft top displacement reaches 2 inches, or to the maximum extension of the load cell. When the load cell will be used for a subsequent loading stage, the Engineer may interrupt the loading sequence at a load cell opening of approximately 3 inches, or less. Each load increment shall be maintained for a minimum period of 5 minutes, with complete sets of readings obtained and recorded from all gauges and instruments at 1, 2 and 5 minutes after application of the load increment. Each increment of load shall be applied within the minimum length of time practical and the instrument system readings shall be taken immediately. It is intended that the addition of a load increment and the completion of the instrument system readings shall be completed within 5 to 15 minutes. The Engineer may elect to hold the maximum applied load for up to one hour.*

*The load shall be removed in decrements of about 10 percent of the maximum test load. Each decrement of load shall be removed within the minimum length of time practical and the instrument system readings shall be taken immediately. It is intended that the removal of a load decrement and the completion of the instrument system readings shall be completed within 5 to 15 minutes. The Engineer may also require a reloading cycle with ten loading increments and five unloading decrements. The final recovery of the drilled shaft shall be recorded for a period up to one hour after the last unload interval.*

Four copies of a preliminary test report containing the load-displacement curves and other test data shall be submitted to the Engineer within three days of completing each load test. Four copies of the final report on the load tests shall be submitted to Engineer within ten days after completion of each load test. The test report shall include at least the following items:

- Test shaft identification number and location.
- Date(s) of testing.
- Description of the test shaft details, instrumentation and test procedures.
- Tables presenting all instrumentation data.
- Plots of load versus displacement (up and down) for each load cell level, for each stage of the test.
- Plots of load along the length of the drilled shaft determined from the strain gauge data for at least ten applied load increments.
- Summary of unit side resistance along the length of the drilled shaft and end bearing resistance.
- Plots of creep displacement for each load increment.
- Plot of equivalent top-of-shaft displacement for the test shaft, developed from the load test data.

After completion of the load test to the satisfaction of the Engineer, and when authorized in writing by the Engineer, the Contractor shall flush all hydraulic fluid from the bi-directional load cells and hydraulic lines, and replace with cement grout in accordance with the approved Drilled Shaft Installation Plan. The Contractor shall also grout any voids remaining outside the load cells after completion of the load test.

## X.6 Technique Shafts

The Contractor shall demonstrate the adequacy of its methods, techniques and equipment by successfully constructing a technique shaft or shafts in accordance with the requirements shown on the Plans and these Specifications. The technique shaft(s) shall be positioned at the location(s) shown on the Plans or as directed by the Engineer, but not less than a clear distance of three drilled shaft diameters from the closest production shaft. The technique shaft(s) shall be drilled to the maximum diameter and maximum depth of any production drilled shaft shown in the Plans. Unless shown otherwise on the Plans, the technique shaft(s) shall be reinforced with the same reinforcement as the corresponding size production shaft, and shall also include CSL tubes as specified herein. Technique shaft(s) shall be completed and accepted by the Engineer prior to initiating installation of the load test shafts and foundation drilled shafts. Failure by the Contractor to demonstrate to the Engineer the adequacy of methods and equipment shall be reason for the Engineer to require alterations in equipment and/or method by the Contractor to eliminate unsatisfactory results. Any additional technique shaft(s) required to demonstrate the adequacy of altered methods or construction equipment shall be at the Contractor's expense. Once approval has been given by the Engineer to construct production drilled shafts, no changes will be permitted in the methods or equipment used to construct the satisfactory technique shaft(s) without the written approval of the Engineer.

The technique shaft(s) will be used by the Engineer to determine if the Contractor can: control dimensions and alignment of excavations within tolerance; install casing and remove temporary casing; seal the casing into impervious materials; control the size of the excavation under caving conditions by the use of a mineral or polymer slurry or by other means; properly clean the completed drilled shaft excavation; construct drilled shafts in open water areas; handle and install reinforcing cages; satisfactorily place concrete meeting the Specification requirements within the prescribed time limit; and to satisfactorily execute any other necessary construction operation.

The purpose of specifying a technique (trial or method) shaft or multiple technique shafts is twofold: first, to verify that the Contractor has the necessary expertise to complete the work successfully and, second, to determine if the proposed equipment and procedures are appropriate for the site conditions. Technique shafts are not necessary for every project; however, technique shafts should be considered for any of the following situations:

- Site conditions are difficult or unusual for drilled shaft installation,
- The production drilled shafts are non-redundant foundation elements,
- Use of the wet method of drilled shaft construction, or
- For drilled shafts with diameter or depth greater than those commonly used in practice within the project area.

*When authorized in writing by the Engineer, the technique shaft(s) shall be cut off not less than 2 feet below finished grade and left in place. The disturbed areas at the sites of the technique shaft(s) shall be restored as nearly as practical to their original condition.*

## X.7 MEASUREMENT AND PAYMENT

### X.7.1 Measurement

*The cost for mobilization for drilled shaft construction should be included in a project-wide pay item for Mobilization rather than included in the unit prices for drilled shaft items or having a separate mobilization item limited to drilled shaft construction.*

#### X.7.1.1 Drilled Shafts in Soil

Soil excavation for drilled shafts including haul will be measured by the lineal feet of *drilled* shaft excavated for each diameter. The lineal feet will be computed using the top of shaft soil excavation, as defined below, and the bottom elevation shown in the Plans, unless adjusted by the Engineer, less all rock excavation measured as specified in item X.7.1.2.

Except as otherwise specified, the top of shaft soil excavation shall be defined as the highest existing ground point within the *drilled* shaft diameter. For *drilled* shafts where the top of shaft is above the existing ground line and where the Plans show embankment fill placed above the existing ground line to the top of the *drilled* shaft and above, the top of shaft soil excavation shall be defined as the top of shaft concrete. Excavation through embankment fill placed above the top of shaft will not be included in the measurement.

*An alternative to separate measurement and payment provisions for soil and rock excavation is to treat both soil and rock excavation as "Unclassified Excavation." See discussion in Section 18.9 of this Manual.*



### X.7.1.2 Drilled Shafts in Rock

Rock excavation for drilled shafts including haul will be measured by the lineal feet of *drilled* shaft excavated for each diameter. The lineal feet will be computed using the *drilled* shaft diameter shown in the Plans, the top of the rock line, defined as the highest bedrock point within the *drilled* shaft diameter, and the bottom elevation shown in the Plans, unless adjusted by the Engineer.

Rock is defined as that consolidated mass of mineral material having an Unconfined Compressive Strength (UCS) in an intact sample of at least one sample of 1000 psi minimum. This definition falls between Class 1 and 2 of the relative rating system for rock classification outlined in Table 10.4.6.4-1 of the AASHTO LRFD Bridge Design Specifications.

Top of rock elevation for bidding purposes will be determined by the Geologist's or *Geotechnical Engineer's* determination in the Contract Documents. Actual top of rock for payment purposes may differ from that shown in the Contract Documents based on the rock definition contained in *Subsection CX.7.1.2*.

The geologic determination for measurement purposes may be different from top of rock for design purposes to account for decomposed, weathered or shattered rock, or *variable rock surface*.

In some formations, such as Pinnacle Limestone, top of rock elevations may vary widely across the *drilled* shaft diameter, precluding the use of a single boring to accurately determine top of rock.

Some regional practices, such as the use of rig penetration rates to determine the top of rock, may need to be considered when developing rock pay quantities.

### X.7.1.3 Obstruction Removal

Obstructions identified under Subsection X.4.4 will be measured per hour of time spent working on obstructions.

Alternatively, obstruction removal can be paid based on a force account basis.

The use of an hourly rate eliminates the necessity to maintain records of equipment on site and determine whether equipment was being used, on standby or available for use elsewhere.

The hourly rate method does leave the process open to abuse through unbalanced bidding. *The hourly rate method requires monitoring of the time taken for obstruction removal, and agreement between the Contractor and Engineer on the level of effort and time required for obstruction removal.*

The alternative method of measuring and paying for obstruction removal includes payment on Force Account. While this eliminates the abuses of bid unbalancing, it does create a tremendous amount of administration to determine rates for equipment not commonly rated and record all equipment used or on standby. In addition, careful tracking of equipment used and the effect of the obstruction removal on equipment on site, not used directly for obstruction removal but subsequently idled by the obstruction event will be needed.

Obstruction measurement and payment can be limited to unanticipated obstructions only. This method limits the incidence of obstructions and their payment. However, it places a heavy burden on the foundation report to accurately describe all known obstructions, and also encourages the Contractor to carry costly contingencies in its bid, and thereby potentially increasing bid prices unnecessarily.

#### X.7.1.4 Technique Shafts

Drilled shafts which are installed prior to installation of contract *drilled* shafts for the purpose of demonstrating to the engineer the adequacy of the methods proposed will be measured per each for *technique* shafts installed successfully.

#### X.7.1.5 Exploration Holes

Exploration holes specified by Contract or *directed* by the Engineer for purposes of confirming geotechnical properties of soil and rock and to determine the founding elevation of the proposed *drilled* shafts will be measured per lineal foot for Exploration Holes installed. Exploration holes may be drilled prior to *drilled* shaft excavation or from the base of the *drilled shaft* excavation. The top elevation will be defined as the ground surface at time of exploration hole drilling. The bottom of *hole* elevation will be defined as the bottom of the exploration hole *approved by the Engineer*.

#### X.7.1.6 Permanent Casing—Furnishing and Placing

Furnishing and placing permanent casing will be measured by the number of linear feet of each diameter of required permanent casing installed, as specified in Subsection X.3.3 of this Specification. Upper limit of casing payment will be defined as the lower of a) original ground or b) base of footing if excavated prior to drilled shaft installation. Lower limit will be the elevation indicated in the Contract Plans.

*Alternatively, for payment purposes, both the top and bottom of permanent casing levels can be defined on the Plans. This approach is appropriate for cases where the limits of the permanent casing are defined by structural design requirements.*

#### X.7.1.7 Load Tests

Load tests, performed in accordance with these Specifications and accepted by the Engineer, are measured per each for test shafts successfully installed in accordance with the dimensions and details shown on the Plans, and carried successfully to the capacity specified or to shaft failure.

*This item includes the work for both installing the load test shaft and performing the load test.*

#### X.7.1.8 Cross Hole Sonic Logging Casing

CSL access tube will be measured by the linear feet of tube furnished and installed.

When the Contract requires a minimum penetration into a bearing layer, as opposed to a specified shaft tip elevation, and the bearing layer elevation at each drilled shaft cannot be accurately determined, replace Subsections X.7.1.8 with:

“CSL access tube will be measured by the linear foot of tube required based on the design depth shown in the Plans plus the length required to extend the drilled shaft reinforcement by \_\_\_% in length.”

*If CSL tubes are to be installed in all drilled shafts, the cost of the CSL tubes can be included in the pay item for Drilled Shaft Construction. This simplifies administration time for tracking CSL tube quantities.*

#### X.7.1.9 . Drilled Shaft Construction

Concrete Class xxxx for drilled shafts will be measured by the cubic yards of concrete in place. The cubic yards will be computed using the *drilled* shaft diameter shown in the Plans, and the top and bottom elevations shown in the Plans, unless adjusted by the Engineer.

In cases where concrete is poured to limits of excavation (i.e. to the ground surface) consideration should be given to combining bid items such as excavation, concrete placement, reinforcing steel placement (where rebar cages are constant in section throughout the entire shaft), and *CSL tubes*.

#### X.7.1.10 Reinforcing Steel

Steel reinforcing bar for drilled shafts will be measured by the computed weight of all reinforcing steel in place, as shown in the Plans. Bracing for steel reinforcing bar cages shall be considered incidental to this item of work.

#### X.7.2 Payment

##### X.7.2.1 Drilled Shafts in Soil

"Soil Excavation for Drilled Shafts Including Haul," per lineal foot for each diameter, including all costs in connection with furnishing, mixing, placing, maintaining, containing, collecting, and disposing of all mineral, *polymer*, and water slurry and disposal of all excavated materials. Temporary casing required to complete *drilled* shaft excavation is included in this bid item.

##### X.7.2.2 Drilled Shafts in Rock Excavation

"Rock Excavation for Drilled Shafts Including Haul", per lineal foot for each diameter, including all costs in connection with disposal of spoil and associated water. Temporary casing, if necessary, is included in this Bid Item.

### X.7.2.3 Obstruction Removal

Payment for removing *drilled* shaft obstructions, will be made for the changes in *drilled* shaft construction methods necessary to remove the obstruction, and *approved by the Engineer*, based on hours spent at Contract bid rates.

See commentary in *Subsections CX.4* and *CX.7.1.3* for additional guidance.

### X.7.2.4 Technique Shafts

Technique Shafts will be paid on the basis of number of shafts *shown on the Plans or* directed by the Engineer and installed successfully. Payment for technique shafts will include mobilization, excavation and disposal of drill spoil, concrete, *CSL tubes* and rebar, if necessary.

### X.7.2.5 Exploration Holes

Exploration holes installed *in accordance with the Contract Documents* or at the direction of the Engineer will be paid per linear foot of exploration hole installed.

### X.7.2.6 Permanent Casing – Furnishing and Placing

Furnishing and Placing Permanent Casing for \_\_\_ Diam. Shaft, per linear foot

### X.7.2.7 Load Tests

Load tests will be paid per test *shaft successfully installed and successfully loaded* to failure or load specified.

### X.7.2.8 Crosshole Sonic Logging Casing

"CSL Access Tube", per linear foot installed.

See Commentary for *Subsections CX.7.1.8* and *CX.7.1.9*.

If crosshole sonic log testing is to be provided by the Contractor, add the following Measurement and Payment subsections:

"Mobilization for CSL Test Paid per each Mobilization to perform CSL tests.

"CSL Test, per each shaft tested.

CSL test will be measured once per shaft tested."

#### X.7.2.9 Drilled Shaft Construction

"Concrete Class xxxx for Drilled Shafts", per cubic yard

#### X.7.2.10 Reinforcing Steel

"Steel Reinforcing Bar for Drilled Shafts," per pound, including all costs in connection with furnishing and installing steel reinforcing bars, stiffeners, spacers and centralizers.

## CHAPTER 19

### INSPECTION AND RECORDS

Inspection and documentation of drilled shaft construction is a particularly important element of any drilled shaft foundation project. Unlike driven pile foundations where the driving resistance provides an indication of the nominal resistance of the pile, the successful installation of drilled shafts can only be assessed by verifying that the drilled shafts were installed in conformance with the contract documents and the approved Drilled Shaft Installation Plan, and in a manner consistent with the procedures used for the successful technique shafts and test shafts. Inspection is also needed to identify any unanticipated conditions encountered during construction that might jeopardize the performance or structural integrity of the completed shaft. In addition to observing drilled shaft construction, a complete written documentation of the work is essential for clearly communicating the drilled shaft construction activities to others, and to provide a permanent record of the work performed at each drilled shaft location. These records, coupled with post-construction integrity testing, also provide the primary means for identification and initial assessment of potential problems with a completed drilled shaft.

This chapter provides a general overview of the roles and responsibilities of personnel performing inspection of drilled shaft construction, and highlights specific issues to be addressed as part of the shaft inspection process. Also included are guidelines for preparing the necessary drilled shaft inspection records. For a more complete discussion of drilled shaft inspection procedures, the reader is referred to the training course for “Drilled Shaft Foundation Inspection” (NHI Course No. 132070) offered through the FHWA (Williams, et al, 2002), and to the “Drilled Shaft Inspector’s Manual” prepared jointly by the ADSC: The International Association of Foundation Drilling and the Deep Foundation Institute (2<sup>nd</sup> Edition, 2004). ADSC also provides informative videos demonstrating the various activities for inspecting the installation of drilled shafts, including the “Drilled Shaft Inspector’s Video,” “Construction and Inspection of Drilled Shafts Using the Slurry Method,” “Concrete Placement” and “Safety in Foundation Drilling.”

#### 19.1 RESPONSIBILITIES

On a conventional design-bid-build project, the drilled shaft inspector may be an employee of the owner or of a construction management firm engaged by the owner to provide construction inspection services. In general, the role of the inspector is to monitor the construction process so that the necessary records can be made, and to provide timely information to the engineer and/or the owner concerning unanticipated conditions, and deviations from the drawings, specifications or the approved Drilled Shaft Installation Plan. The inspector should communicate and compare observations with the contractor, but the inspector does not direct the construction process; only the contractor has the authority to direct the construction operations and contractor personnel.

In a design-build contract, the drilled shaft inspector may be employed by the owner or a construction inspection firm hired by the owner, but more typically is a representative of a quality control organization that is hired by the design-builder, but is functionally independent of the design-builder’s organization. If the inspector is an employee of the design-builder’s independent quality control group, the inspector will typically communicate with the designer-of-record and construction staff of the design-builder, and with the quality assurance staff engaged by the owner. In essentially all other respects, the roles and responsibilities of the drilled shaft inspector will be the same for both design-bid-build and design-build type construction contracts.

Due to the specialized nature of drilled shaft construction and the particularly important role of the drilled shaft inspector for observing and documenting the work, the assigned drilled shaft inspector must be qualified by training and experience to perform this role. It is recommended that all drilled shaft inspectors successfully complete a drilled shaft inspector's training course, such as the one offered through the FHWA (Williams, et al, 2002), and be certified for this work. In addition, the inspector should have prior experience as a drilled shaft inspector, or work under the supervision of an experienced drilled shaft inspector until the individual has obtained the necessary training and experience to serve as a drilled shaft inspector.

The drilled shaft inspector is typically a technician who has the appropriate training and experience for this work. A geotechnical engineer experienced with drilled shaft construction can also be a suitable drilled shaft inspector.

The inspector(s) should participate in pre-construction coordination meetings that address drilled shaft installation to better understand project requirements and the contractor's Drilled Shaft Installation Plan, as well as to hear the particular concerns of the designer and the contractor. Pre-construction meetings are also useful for clearly reviewing the responsibilities of the drilled shaft inspector(s) and the procedures for preparing and submitting inspection forms, and for establishing the required lines of communication during construction.

At the beginning of any drilled shaft project, or when initially introduced to an on-going project, the drilled shaft inspector should meet with the foundation designer and/or geotechnical engineer for a briefing on the key issues and criteria applicable to that particular project. The inspector must also become familiar with all project documents related to the installation of the drilled shafts, as noted below.

Following are the specific roles and responsibilities of the drilled shaft inspector:

- Attend pre-construction meetings and construction meetings with the designer, the geotechnical engineer and the contractor, as appropriate,
- Be familiar with site conditions, including maintenance of traffic requirements, permit issues, utilities, etc.,
- Be familiar with general subsurface conditions, including types of soil and rock materials, and groundwater levels anticipated from the geotechnical exploration borings,
- Be familiar with the relevant contract drawings, specifications, specification special provisions and payment provisions applicable to the drilled shaft foundations,
- Be familiar with the approved Drilled Shaft Installation Plan (Section 18.8), particularly information related to the procedures and equipment to be used, and verify that the available Plan is the most current,
- Be familiar with the drilled shaft installation criteria and tolerances,
- Have available all necessary inspection equipment, and verify the equipment is calibrated and in good operating condition (discussed in Section 19.2.1),
- Have available a sufficient number of blank forms to record the work (Section 19.5),
- Observe and document all drilled shaft activities (Sections 19.2),
- Observe field testing of slurry (Section 19.2.3),
- Perform field testing of concrete, and prepare concrete cylinder samples for laboratory testing (Section 19.2.6),



- Immediately inform the geotechnical engineer, resident engineer and/or owner of any unanticipated conditions, problems or non-conforming work observed during drilled shaft installation, and
- Measure and record the drilled shaft quantities used for payment purposes.

The inspector should have available in the field all relevant documents for the drilled shaft location under construction. Typical reference documents may include: the plan and details for the foundation unit; the specifications and specification special provisions for drilled shafts; the latest version of the Drilled Shaft Installation Plan; any additional instructions or installation criteria from the geotechnical engineer; and logs of the exploratory borings nearest to the foundation.

Prior to initiating drilled shaft construction, procedures should be established for the timely communication of information between the inspector and the geotechnical engineer, the resident engineer and/or the owner to quickly address any questions or problems that may arise. Timely resolution to construction issues is essential to avoid delay in the completion of the drilled shaft, and particularly to avoid constructing a defective or potentially deficient drilled shaft. It is the inspector's responsibility to immediately inform the geotechnical engineer, the resident engineer and/or the owner of any unanticipated conditions, problems or non-conforming work, and it is the designer's and/or geotechnical engineer's responsibility to assess the information provided by the inspector, and to quickly respond to the contractor to help resolve the issue. Delays in the work need to be avoided or minimized not only because they impact the contractor's construction schedule but, more importantly, such delays may jeopardize the stability of the shaft excavation or the performance of the completed shaft.

The inspector's role extends beyond that of just an observer and recorder of construction activities; the inspector must also make judgments of the observed installation activities and communicate identified issues to the engineer and/or owner for quick resolution rather than delay action until after completion of the drilled shaft when the cost and schedule impacts associated with correcting a problem shaft will be considerably greater. With this objective in mind, it is appropriate for the inspector to share observations with the drilled shaft superintendent to allow the contractor to become immediately aware of a potential shaft installation issue, and thereby provide the contractor opportunity in certain circumstances to address the issue directly, without delay. As noted previously, however, the inspector does not have authority to direct the contractor's operations in any way. And even if an observed condition is addressed by the contractor's field personnel, the inspector is still responsible for documenting the issue and communicating it to the engineer and/or owner for their consideration.

It is the responsibility of the contractor to determine the means and methods of drilled shaft construction suitable for the existing site conditions and in conformance with the requirements of the contract documents. The contractor is also responsible for installing the drilled shafts in accordance with the approved Drilled Shaft Installation Plan and in a manner consistent with the procedures used for the successful technique shafts and load test shafts. In addition, the contractor is responsible for constructing drilled shafts with the structural integrity necessary for their intended purpose.

## **19.2 INSPECTION ACTIVITIES**

The inspector is responsible for observing all work performed during the various stages of drilled shaft installation, from initial set-up to completion of concrete placement, including removal of any temporary casing. Specific activities performed by the drilled shaft inspector during these various stages of drilled shaft construction are outlined below.

A sample checklist of drilled shaft inspector tasks is presented in Table 19-1. A checklist similar to the one shown should be developed to incorporate the specific requirements for each particular project.

**TABLE 19-1 DRILLED SHAFT INSPECTOR'S CHECKLIST**

<b>Contractor and Equipment Arrive on Site</b>	<b>YES</b>	<b>NO</b>	<b>N/A</b>
1. Has the Contractor submitted a Drilled Shaft Installation Plan?			
2. Has the Drilled Shaft Installation Plan been approved?			
3. Does Contractor have an approved concrete mix design?			
4. Has Contractor run the required Trial Mix and slump loss test for their concrete mix design?			
5. If concreting is estimated to take over two hours, has Contractor performed a satisfactory slump loss test for the extended time period?			
6. If Contractor proposed a mineral or polymer slurry, do they have an approved Slurry Management Plan?			
7. Have you attended pre-construction conference with the Engineer and Contractor for clarification of drilled shaft installation procedures and requirements?			
8. Is Contractor prepared to take soil samples or rock cores on the bottom of the shaft, if required in the Contract Documents?			
9. Has the Contractor met the requirements for protection of existing structures?			
10. Has the site preparation been completed for footing?			
11. Does Contractor have all the equipment and tools shown in the Drilled Shaft Installation Plan?			
12. If casing is to be used, is it the right size?			
13. If Contractor plans to use a slurry, do they have the proper equipment to mix it?			
14. Is the manufacturer's representative on site at the start of slurry work?			
15. If a slurry desander is required, does Contractor have it on site and operational?			
16. Does Contractor's tremie meet the requirements of the Specifications?			
17. Do you have all the drilled shaft forms that are needed during shaft construction?			
18. Do you understand all of the forms? (If not, contact Engineer for assistance.)			
<b>Technique Shaft</b>			
19. Is the technique shaft positioned at the approved location?			
20. Has Contractor performed a successful technique shaft as specified?			
21. Did Contractor cut off the shaft below grade as specified?			
22. Has Contractor revised the procedures and equipment (and the revision approved) to successfully construct a shaft?			
<b>Shaft Excavation and Cleaning</b>			
23. Is the shaft being constructed in the correct location and within tolerances?			
24. Does Contractor have a benchmark for determination of the proper elevations?			
25. If core holes are required, has Contractor taken them in accordance with the Specifications?			
26. If a core hole was performed, was a Rock Core form completed and did Contractor maintain a log?			
27. If Contractor is using slurry, did they perform tests and report results in accordance with the Specifications?			
28. Is the slurry level being properly maintained at the specified level?			
29. Are the proper number and types of tests being performed on the slurry?			

30. Are you filling out the Soil and Rock Excavation forms?			
31. If permanent casing is used, does it meet requirements of Contract Documents?			
32. If temporary casing is used, does it meet the requirements of the Specifications?			
33. If bellling is required, does it meet the requirements of the Contract Documents?			
34. Is the shaft within allowable vertical alignment tolerance?			
35. Is the shaft of proper depth?			
36. Does the shaft excavation time meet the specified time limit?			
37. If over-reaming is required, was it performed in accordance with Specifications?			
38. Does the shaft bottom condition meet the requirements of the Specification?			
39. Did you complete the Drilled Shaft Inspection form?			
<b>Reinforcing Cage</b>			
40. Is the rebar the correct sizes and configured in accordance with the project plans?			
41. Is the rebar properly tied in accordance with the Specifications?			
42. Does Contractor have the proper spacers for the steel cage?			
43. Does Contractor have the proper amount of spacers for the steel cage?			
44. If steel cage was spliced, was it done in accordance with Contract Documents?			
45. Is the steel cage secured from settling and from floating?			
46. Is the top of the steel cage at proper elevation in accordance with Specifications?			
<b>Concrete Placement</b>			
47. Prior to concrete placement, has the slurry (both manufactured and natural) been tested in accordance with the Specifications?			
48. If required, was the casing removed in accordance with the Specifications?			
49. Was the discharge end of the tremie maintained at the specified minimum embedment in the concrete			
50. If free-fall placement (dry shaft construction only), was concrete place in accordance with the Specifications?			
51. Did concrete placement occur within the specified time limit?			
52. Are you filling out the Concrete Placement and Volume forms?			
53. Did Contractor overflow the shaft until good concrete flowed at the top of shaft?			
54. Were concrete acceptance tests performed as required?			
<b>Post Installation</b>			
55. If shaft is constructed in open water, is the shaft protected for seven days or until the concrete reaches a minimum compressive strength of 2500 psi?			
56. Is all casing removed to the proper elevation in accordance with Specifications?			
57. If required, has Contractor complied with requirements for Integrity Testing?			
58. Is the shaft within the applicable construction tolerances?			
59. Has the Drilled Shaft Log been completed?			
60. Have you documented the pay items?			
<b>Notes/Comments:</b>			

### 19.2.1 Set-Up

Following is a checklist of tasks that need to be performed by the inspector prior to the start of drilled shaft installation operations:

- Attend pre-construction meetings to become familiar with the planned drilled shaft construction procedures and installation criteria, and to understand the potential conditions and problems that may be encountered.
- Become thoroughly familiar with the project drawings and specifications for the drilled shaft foundations, and with the approved Drilled Shaft Installation Plan.
- Observe the existing conditions at the work site.
- Check all inspection equipment and verify they are in proper working condition and have been calibrated, where necessary. Inspection equipment will include measuring tape, weighted sounding tape, 4-ft long level, carpenter's square, slurry testing equipment (if necessary), concrete testing equipment, and concrete sample molds, among others.
- Have the necessary safety equipment including hard hat, appropriate boots, safety glasses, safety harness, ect.
- Collect the necessary inspection forms, and review with the geotechnical engineer the information to be recorded.
- Collect all project documents relevant to the specific drilled shaft being installed.
- Verify that the construction tools are in accordance with the equipment list presented in the approved Drilled Shaft Installation Plan.
- Check the dimensions of all drilling tools, and verify they are consistent with the design diameter of the drilled shaft and any rock socket.
- Check the dimensions of temporary and permanent casing (See Section 19.2.2).
- Check the steel reinforcing cage (See Section 19.2.5).
- Verify the protocol for communicating with the owner, geotechnical engineer, resident engineer and contractor, and have available a list of contact phone numbers.
- Photograph drilling tools, casing, typical rebar cage and other equipment for further documentation and future reference.
- Attend the project safety training program, be familiar of safety procedures, use appropriate safety equipment, and obtain contact phone numbers for use in emergency situations.

### 19.2.2 Casing

The inspector should verify that the dimensions of temporary casing, including diameter, wall thickness and length, and any tip reinforcement or bands are consistent with the information presented in the approved Drilled Shaft Installation Plan. For permanent casing, the inspector should verify the casing dimensions and grade of steel are in accordance with the contract plans, and check that casing straightness and distortion to the cross-sectional shape are within specified tolerances. In addition, the inspector should verify that the necessary inspection and weld testing of splices have been performed and documented.

As the casing is set in position, the inspector should check that the location and verticality of the casing are within the specified tolerances. Position can be measured by offset from established survey reference points. Verticality can be checked by use of a 4-ft long level, or by plumb bob.

The inspector should note the method used to advance the casing, and any difficulty encountered during casing installation including unexpected resistance, tilting or “walking” of the casing. The inspector should record the start and completion time for casing installation, and the cause, times and duration of any delays that occur, including stoppages for splicing the casing. At the completion of casing installation, the inspector should record the top and bottom elevations of the casing based on survey data provided by the contractor. For permanent casing, the casing elevations must be in accordance with the drawing elevations, within the specified tolerance.

### **19.2.3 Drilling Fluid**

The type of drilled fluid used, if any, should be in accordance with the approved Drilled Shaft Installation Plan. If slurry is used, the inspector should confirm that the proper slurry type is used and that it is mixed, placed and treated in accordance with the slurry manufacturer’s recommendations, as presented in the approved Drilled Shaft Installation Plan.

The inspector should observe slurry tests to verify they are performed in accordance with the type of tests and frequency of testing detailed in the project specifications. Detailed procedures for performing tests on drilling slurry are presented by Williams, et al (2002) (Slurry tests are usually performed by the contractor and monitored by the inspector). The inspector should record all slurry test results and confirm that they are in accordance with the specified criteria, or in accordance with the slurry manufacturer’s recommendations if not addressed in the project specifications. The performance of the slurry must be evaluated by the inspector during shaft excavation operations; if the slurry is inadequate for support of the excavation, or if the specified slurry properties cannot be achieved, the contractor is required to modify the slurry mix to achieve the specified performance. When testing is performed by the inspector, test results should be shared with the contractor for their use in adjusting the slurry mix.

The proper performance of the slurry is essential for the successful installation of drilled shafts by the wet method of construction. It is therefore particularly important that the inspector understand the use of slurry and the testing methods used for verifying compliance with specified slurry properties, as discussed in Chapter 7.

### **19.2.4 Drilled Shaft Excavation**

Following is a checklist of tasks that need to be performed by the inspector during drilled shaft excavation operations:

- Verify the location of the top of the drilled shaft has been determined, and is within the specified tolerance.
- Note and document the excavation equipment used by the contractor, and verify it is consistent with the approved Drilled Shaft Installation Plan, and note any changes during shaft excavation.
- Verify excavation procedures are in accordance with the requirements of the drawings and specifications, and consistent with the approved Drilled Shaft Installation Plan.
- Periodically check the verticality of the excavation by holding a 4-ft level on the Kelly bar, or by other suitable method.
- Sound the excavation depth at frequent intervals, and record the excavation elevation and corresponding time on the drilled shaft excavation log.
- If temporary casing is used, the bottom elevation of the casing and time of measurement should be recorded on the drilled shaft excavation log. Casing elevation should be recorded at the same times as the measurements for excavation elevation.

- If the dry method of construction is used, verify the temporary and/or permanent casing is properly sealed in an impermeable stratum based on observed seepage into the excavation.
- For the dry method of construction, verify the water infiltration rate and depth of water at the base of the shaft excavation are within the specified limits.
- For the wet method of construction, verify the slurry or water level is maintained at or above the specified minimum level.
- Perform slurry testing as discussed in Section 19.2.3 and Chapter 7.
- Observe the cuttings from the excavation, and record a description of these materials on the drilled shaft excavation log; correlate the materials encountered with the information shown in the logs for nearby subsurface investigation borings. Note elevation of each change in material encountered.
- Document the time and equipment used for advancing the drilled shaft past obstructions.
- When a probe hole below the bottom of the excavation is required by the specifications, verify the probe hole is performed and document the conditions encountered including material description, drilling advance rate, observations from the use of a feeler rod on the side of a rock socket for assessment of socket roughness or the presence of voids, etc. It is preferable to perform the probe hole prior to the start of shaft excavation to avoid interruption of the work, but this is typically at the option of the contractor.
- The cross-section of the shaft is generally estimated based on the diameter of the drilling tools used; when a more accurate measurement of shaft cross-section is desired (such as for load test shafts or cases where cavities or voids are suspected), a mechanical or sonic calibration device as shown in Figure 19-1 can be used.
- Document final bottom cleaning operations, including the type(s) of equipment used, the method used to check the bottom condition, and the results of the bottom inspection. Bottom elevation and bottom cleanliness are commonly determined with a weighted tape by sounding on four sides of the shaft as well as the center. A neutral buoyancy rod can be used for assessing bottom cleanliness. In the last decade, bottom inspection has increasingly been performed with the use of a video camera device as shown in Figure 19-2. The bottom inspection tool shown in Figure 19-2, called a Shaft Inspection Device (SID), is essentially a diving bell that utilizes compressed gas to displace the water from the device for viewing the bottom condition in a wet excavation. The device is operated by a) setting the device on the bottom of the hole, typically at the center of the drilled shaft and at the four orthogonal sides of the shaft, b) pressurizing the gas to displace the slurry or water from the device, and c) viewing the bottom condition with the use of a video camera and one or more sediment measuring depth gauges mounted in view of the camera.



Figure 19-1 Setting Up a Sonic Caliper for Profiling a Drilled Shaft



Figure 19-2 Shaft Inspection Device for Visual Inspection of the Shaft Bottom in a Wet Excavation (60-inch diameter shaft shown).

- Document any unusual or unanticipated conditions observed during drilled shaft excavation including, but not limited to, the presence of boulders or other obstruction; evidence of caving, bottom heave or other signs of hole instability; soil or rock conditions significantly different than those indicated in nearby investigation borings; slow or difficult drilling progress; loss of drilling fluid; changes in groundwater conditions; whenever the time of drilled shaft excavation exceeds the specified time limit; or any other conditions that may potentially impact friction or end bearing resistance of the drilled shaft, as noted by the geotechnical engineer.
- Immediately notify the geotechnical engineer of unusual or unanticipated conditions.

Current practice for inspection of the base of the shaft excavation typically relies on inspection made from the surface. It is recommended that inspection personnel not enter the drilled shaft unless it is absolutely necessary, and then only if all prudent and required safety precautions are taken.

The geotechnical engineer should review each of the drilled shaft excavation logs to verify that the work was performed in general accordance with the contract documents and with the approved Drilled Shaft Installation Plan, and is compatible with the friction and end bearing resistance requirements for the shaft.

### 19.2.5 Placement of Reinforcement

In most cases, the steel reinforcement is delivered to the project site as individual bars in predetermined lengths and shapes for fabrication into rebar cages at the job site. Alternatively, pre-assembled cages may be delivered to the job site. Inspection of the reinforcement includes the following tasks:

- If steel coupon testing is required, the inspector should verify that the necessary coupon samples have been taken for testing by others.
- Verify that the individual bars and the fabricated rebar cage are supported off the ground, and protected against contamination by soil, grease and other deleterious material.

- Check the rebar cages after they are fabricated to verify that they are in agreement with the steel grade, dimensions, arrangement, sizes and spacing shown on the design drawings or approved shop drawings, and in accordance with the specifications.
- Verify that intersecting bars of the rebar cage have been suitably tied with wire in accordance with the contract requirements or the approved Drilled Shaft Installation Plan.
- Verify that centering devices are installed in accordance with the sizes and spacing specified and shown in the approved Drilled Shaft Installation Plan. The inspector should also verify rebar cage bottom spacers (“boots”) are installed, if required.
- Verify that CSL tubing is installed in accordance with the contract specifications and the approved Drilled Shaft Installation Plan. The inspector should verify that the tubes are of the specified material; are undamaged and straight; have the required length and extend to the specified bottom level; have suitable watertight couplers and end caps; and are securely attached to the rebar cage in the required number and arrangement.
- Verify that other embedded devices, including shaft base post-grouting systems, bi-directional load test devices, and instrumentation have been installed, where required. Typically, a specialty subconsultant will be responsible for detailed inspection and verification checks of these atypical embedment items.
- Observe the lifting of the rebar cage to determine if there is any damage or permanent distortion to the rebar cage, CSL tubes, or any embedded items due to the lifting operation.
- If the cages are spliced as they are lowered into the drilled shaft excavation, the inspector must verify that the splices are performed in accordance with the requirements of the drawings, specifications, and approved Drilled Shaft Installation Plan, particularly noting splice lap lengths; the type, size and installation procedure for mechanical splices; and the staggering of the splices.
- Confirm that temporary internal stiffeners are removed from the cage as it is being lowered into the shaft excavation.
- Verify that any missing or damaged centering devices are replaced as the cage is lowered into the shaft excavation.

The inspector should be alert to cage installation procedures that may increase the risk of soil or rock material being dislodged from the side of the shaft excavation as the cage is lowered into the hole. Procedures that may pose such a condition include: rapid lowering of the rebar cage; not maintaining the cage concentric with the drilled shaft excavation; missing or damaged centering devices; and protrusion of rebar steel or other embedded items beyond the outside diameter of the cage. Following installation of the rebar cage, the inspector should sound the bottom of the shaft excavation when possible to assess the presence of debris on the bottom. If there is a noticeable change from the condition or elevation determined just prior to placement of the reinforcement cage, the inspector should immediately inform the geotechnical engineer. In certain cases the engineer may not accept such a condition, and may direct the contractor to remove the reinforcing cage and re-clean the bottom of the shaft.

### **19.2.6 Concrete Placement**

Proper concrete placement is essential to a successful drilled shaft installation free of defects that may jeopardize the structural integrity of the completed shaft. Accordingly, it is particularly important that the concrete placement operations be carefully inspected and documented. Thorough inspection and logging of concrete placement operations are necessary not only to document the work performed, but also to provide the information necessary for assessing possible anomalies identified in subsequent integrity testing of the completed shaft as discussed in Chapter 20.



The inspection of concrete placement operations involves two separate activities including a) concrete sampling and testing, and b) inspection of concrete placement into the shaft excavation. Concrete sampling and testing is essential to verify that the required concrete mix is delivered to the job site and that the concrete has the fluid properties necessary for proper placement, particularly for projects requiring the wet method of construction. Equally important is the inspection of concrete placement into the shaft since improper placement could result in major defects and rejection of the completed shaft. Following are inspector checklists for each of these inspection activities. Further discussion and details of concrete sampling and testing are provided by Williams, et al (2002).

### Concrete Sampling and Testing

- Obtain the delivery ticket for each load of concrete delivered to verify that the proper concrete mix has been furnished and to determine the volume of concrete in the load.
- Verify the mix is appropriate for the ambient temperature conditions at the time of placement. (Since concrete slump loss rate is highly influenced by the ambient air temperature, it is important the mix delivered to the job site is one that has been tested and approved at an ambient temperature equal to or greater than the ambient temperature at the time of placement. This issue is especially important for deep, large diameter drilled shafts that may require an unusually long concrete placement time.)
- Check the batch time to verify that the age of the concrete is within the specified time range.
- Perform routine slump and concrete temperature testing, and air entrainment testing, if required, at the frequency noted in the specifications or directed by the engineer. Slump loss tests (slump tests on the same concrete sample at selected time intervals) are occasionally performed at the placement site using concrete obtained from the initial load delivered to the shaft; such testing provides another means of assessing the fluidity of the mix over time, particularly for shafts with anticipated long concrete placement time or shafts poured during periods of high ambient air temperature conditions.
- Prepare concrete cylinder samples at the frequency noted in the specifications or directed by the engineer. Store samples in an approved manner until time for testing.
- Look for any conditions that may adversely impact concrete placement, including segregation of the aggregate, clumping, insufficient slump, etc.

### Concrete Placement

- Check the rate of water infiltration into the shaft excavation and the height of water at the bottom of the shaft. If either condition exceeds the specified limits, verify the contractor fills the shaft excavation with water or slurry, as appropriate, and places the concrete by the wet method.
- Verify the tremie pipe or pump line has sufficient length to reach the bottom of the shaft excavation.
- Verify the inside and outside surfaces of the tremie pipe or pump line are clean and free of protrusions that may impede concrete flow or extraction of the tremie or pump line from the shaft.
- Verify the tremie pipe or pump line and all joints are watertight.
- Verify that the distance above the bottom of the tremie or pump line is marked and numbered at intervals of not more than 5 feet to allow determination of the depth to the bottom of the tremie or pump line during concrete placement.
- Verify all CSL tubes are filled with water and provided with a removable top cap prior to the start of concrete placement.
- Verify a bottom flap valve is used to prevent water or slurry entering the pipe prior to placing the initial charge of concrete into the tremie or pump line. Alternatively, verify a “pig” of the proper size and material is placed at the top of the pipe to separate the water or slurry from the initial charge of concrete.
- Verify the bottom of the tremie or pump line remains embedded in the concrete the minimum specified depth for the entire placement period.
- In wet excavations, verify the fluid pressure within the casing (drilled fluid and concrete) exceed the external hydrostatic pressure at all times during concrete placement.

- If temporary casing is used, verify the casing is slowly extracted to allow the concrete to flow into the space vacated by the casing.
- If temporary casing is used, verify the top of concrete level remains within the casing until completion of concrete placement.
- If temporary casing is used, verify the casing is pulled vertically out of the shaft to avoid disturbance to the soils around the shaft.
- If the dry method of construction is used, verify that the free-fall height of the concrete drop does not exceed the maximum specified height.
- If the dry method of construction is used, verify the concrete stream does not impact the rebar cage or the side of the shaft excavation.
- Maintain a log of concrete placement as described in Section 19.5.
- During concrete placement, maintain a plot of actual and theoretical concrete volume versus elevation, as described and illustrated in Chapter 9, to assess possible bulging, necking and instability of the shaft.
- Verify the concrete is overpoured until concrete of good quality reaches the top of the shaft. Alternatively, if the contractor elects to chip away any contaminated concrete at the top of the shaft, verify the concrete level extends above the shaft cutoff elevation the minimum amount noted in the approved Drilled Shaft Installation Plan to provide good quality concrete at and below the design cutoff elevation.
- For drilled shafts constructed by the wet method, verify the total concrete placement time, measured from the batching of the initial load of concrete placed in the shaft until the end of concrete placement and removal of any temporary casing, does not exceed the approved maximum placement time for the mix, as determined from slump loss testing of the mix used.
- Immediately inform the engineer of any unusual observations noted during concrete placement operations.

### **19.2.7 Completed Drilled Shaft**

At the completion of each drilled shaft installation the inspector should perform the following tasks:

- Obtain from the contractor the surveyed final, as-built location of the drilled shaft and the actual top of concrete elevation.
- Complete a summary installation form that documents the as-built dimensions and elevations of the drilled shaft, as discussed in Section 19.5.
- For the completed shaft, determine the quantities for each pay item related to drilled shaft installation.
- Compile and file all inspection records for the completed shaft.
- Update any project control summary tables and charts for drilled shaft construction.

## **19.3 COMMON PROBLEMS**

The vast majority of drilled shafts are constructed without problems related to loss of resistance within the bearing strata, or to a defect that compromises the structural integrity of the shaft. When problems occur, they are likely to fall into one of the categories listed in Table 19-2. The inspector should discuss potential problems with the project geotechnical engineer for a better understanding of the risk of these and other types of problems for the anticipated project conditions and selected method of construction. The inspector should then be alert to the construction operations that can produce these problems.

**TABLE 19-2 COMMON PROBLEMS ENCOUNTERED DURING DRILLED SHAFT CONSTRUCTION (after Baker et al., 1993; O'Neil, 1991)**

Type of Problem	Potential Cause of Problem
Shaft off location or out of plumb	Improper set-up or poor alignment while drilling
Shaft not based or with insufficient embedment in proper bearing stratum.	Bearing stratum misidentified or length not properly measured
Crack in shaft	Shaft hit by construction equipment early in curing process
Bulge or neck in the shaft	Soft ground zones that were not cased
Caving of shaft wall	Improper use of casing or slurry; failure to use weighting agent with slurry; casing not sealed in a stable stratum
Reduction in side resistance due to excessive mudcake buildup	Failure to agitate slurry or to place concrete in a timely manner
Temporary casing cannot be removed	Crane for handling casing ineffective in squeezing ground; large set-up of soil friction after installing casing; causing wedged in rock or by boulder
Horizontal separation or severe necking of shaft	Pulling temporary casing with concrete adhering to it
Horizontal sand lens in concrete	Tremie or pump line pulled out of concrete in wet hole; insufficient head within casing when raising casing
Soil intrusion on the side of the shaft	Use of telescoping casing where concrete from inner casing spills into annular void behind the outer casing; low concrete slump; reinforcing bars too closely spaced
Soft shaft bottom or CSL anomaly at/near bottom of shaft	Incomplete bottom cleaning, side sloughing, or sedimentation of cuttings from slurry column
Voids outside of cage	Low concrete slump, aggregate too large, and/or reinforcing bars too closely spaced
Concrete defects	Tremie pipe joints not watertight; tremie/pump line not at bottom of shaft at start of concrete placement; concrete flow into annular void between temporary and permanent casings; concrete slump inadequate for duration of concrete placement; excessive sediment in slurry
Honeycombing, washout of fines or water channels in the concrete	Concrete placed directly into water; excessive groundwater head; excessive bleed water in concrete mix
Folded-in debris	Insufficient cleaning of shaft; excessive sand content in slurry
Clogged tremie or pump line	Concrete with insufficient slump or slump retention; interior of pipe not clean; segregation of concrete aggregates
Rebar cage lifted during concrete placement	Weight of rebar cage insufficient for rising concrete; tremie/pump line embedded too deep in concrete; rebar cage caught on tremie/pump line; concrete arch between casing/cage
Rebar cage settles during concrete placement	Missing or inadequate number/spacing of rebar cage spacers; insufficient support of cage at bottom of shaft excavation; insufficient cage stiffness

## 19.4 DIFFERING SITE CONDITION

When a subsurface condition is encountered during drilled shaft construction that varies considerably from that which could reasonably have been anticipated based on the available bid documents, and when such a condition has a material impact on the progress of the work, the contractor may submit a claim for a “differing site condition” (DSC). Such claims are not unusual considering the variability of natural geomaterials and the limitations in defining such variability even with an extensive subsurface investigation program during design. A DSC claim may also be submitted by a contractor for a condition that may or should have been evident from the available bid documents, but which the contractor failed to recognize or properly prepare for when the project was bid. In this later case, there may be a disagreement between the contractor and owner regarding the legitimacy of the DSC claim. In either case, the drilled shaft inspector’s records will serve as the basic reference for defining the condition encountered and in assessing the impact of the condition on the contractor’s operations.

## 19.5 RECORDS AND FORMS

Contracting agencies typically have standard forms that they use for documenting drilled shaft construction. Such forms may include a checklist for rebar cage fabrication; a fabrication checklist for permanent casing; a shaft excavation log; a shaft excavation bottom inspection form; and concrete placement forms. When contracting agencies develop their own standard inspection logs, they are often attached to the drilled shaft specification section and their use may be a contract requirement. In the absence of standard forms from the contracting agency, the sample inspection forms included in Appendix F may be used for documenting the various drilled shaft construction activities.

The attached sample inspection forms each identify the specific items to be recorded. Much of the specific information to be entered on these forms is self-evident, or has been noted in the preceding sections of this chapter. Sample completed forms are also included in Appendix F to illustrate the type of information to be recorded. Following, however, is a brief discussion regarding general procedures for using these forms.

- Each page of the log should identify the project name, project location, structure identification (for projects with multiple structures), shaft identification number (corresponding to the number shown on the design drawings or working drawings), date, and page number.
- Each page of the log should record the name(s) of the inspector(s), and note the time of any change of inspector during the course of drilled shaft installation.
- Data recorded on the inspection logs should be referenced to elevations rather than depth. The use of elevations eliminates any uncertainty regarding the exact level of the noted item. Recording data in terms of depth should generally be avoided, and used only when the elevation of the reference level is determined by survey and clearly documented on the inspection forms.
- The date and time for the start and completion of all activities, and the beginning and end of any interruptions to the work, need to be recorded on the inspection forms. When repetitive operations are performed, such as the repeated insertion of excavation tools, it is useful to record the time for each step, i.e. the time for each insertion of the drilling tool, and the time when it is removed from the hole. To avoid potential confusion, it is preferred to use a 24-hour (military) clock reading rather than a 12-hour clock reading.

In addition to the inspection forms described above, each inspector should maintain a daily report to record information and construction activities that are normally not entered on the shaft inspection forms. Following is a sample list of just some of the items that might be recorded in the inspector’s daily report:

- Weather conditions, river level, etc.
- Equipment and work force on site.
- Equipment repair or maintenance performed.
- General construction activities not associated with drilled shaft installation, e.g. mobilizing to a new work area, setting up templates, site excavation or filling, etc.
- Delays to the work, e.g. equipment breakdown, weather conditions, change in work schedule, etc.
- Tracking of time and material for unanticipated tasks, such as penetrating obstructions.
- Information obtained from the contractor or the engineer.
- Instructions given to the work crew by the contractor's superintendent.
- Any time spent on other activities not related to drilled shaft construction.

All records must be collected, organized and maintained in a central file in accordance with the document control procedures established for the project. Copies of the drilled shaft inspection logs should be distributed to the project geotechnical engineer in a timely fashion for review and evaluation. Any unusual observations or problems should immediately be brought to the attention of the resident engineer and the project geotechnical engineer for their consideration and follow-up action.

## **19.6 SUMMARY**

This chapter discussed the responsibilities of the drilled shaft inspector and the varied tasks required for monitoring and documenting the work. Sample record keeping forms were also presented illustrating the specific information to be collected for each step in the installation of the drilled shafts.

It was emphasized that the inspector is not just an observer and recorder of the drilled shaft construction activities, but must be proactive in identifying issues and problems that may impact the performance of the completed drilled shaft, and must communicate these observations in a timely manner to the resident engineer and the project geotechnical engineer for evaluation and resolution. It was also emphasized that the inspector does not have the authority to direct the contractor's operation in any way, but should share observations with the contractor's superintendent to allow the contractor the opportunity to make their own assessment and to take action they may consider appropriate to address the identified issue while it is still possible to do so.

As discussed in this chapter, the records collected by the inspector are a fundamentally important element of any drilled shaft project since they serve as the only reliable information that can be used to verify that the drilled shafts were installed in accordance with the requirements of the contract documents and the approved Drilled Shaft Installation Plan, and also serve as the principal means for evaluating the adequacy of the completed drilled shaft.

Archived

This page is intentional left blank.

## CHAPTER 20

### TESTS FOR COMPLETED DRILLED SHAFTS

#### 20.1 INTRODUCTION

Technologies for testing of completed drilled shafts have developed and evolved rapidly over the past 25 to 30 years. Post-construction testing is now an integral part of the drilled shaft design and construction process. The most common purpose of post-construction testing is quality assurance of concrete placement, in which some characteristic of the hardened concrete is measured to assess its integrity. Most tests used for this purpose have no permanent effect on a drilled shaft and are therefore referred to as “non-destructive integrity tests”, or NDT. The interpretation and use of NDT for drilled shaft assessment is referred to as “non-destructive evaluation” or NDE. In combination with quality construction and inspection practices, NDE provides a tool for ensuring the as-built foundation satisfies the construction specifications and will perform as assumed in the design. A major point of emphasis in this manual is that NDE must be viewed within the context of a well-designed and executed inspection process and not as a substitute for quality construction or inspection.

A second application of the tests described in this chapter is to evaluate drilled shafts when there is reason to suspect that a defect exists. Most drilled shafts are constructed routinely, without difficulty, and are sound structural elements. On occasion, however, there is reason to question the integrity of a drilled shaft on the basis of construction observations, anomalous results of routine tests, or unexpected performance during construction of the superstructure (*e.g.*, excess settlement). In these cases, the objective of testing is to define the potential problem and obtain information that can be used to determine if a remediation plan is needed. These tests may include both non-destructive and destructive (*e.g.*, concrete coring) methods.

From a management perspective, post-construction tests on completed drilled shafts can be placed into two categories:

- Planned tests that are included as a part of the quality assurance procedure, and
- Unplanned tests that are performed as part of a forensic investigation in response to observations made by an inspector or contractor that indicate a defect might exist within a shaft.

Planned tests for quality assurance typically are non-destructive and are relatively inexpensive. Such tests are performed routinely on drilled shafts for transportation projects in the United States. Unplanned tests performed as part of a forensic investigation will normally be more time-consuming and expensive, and the results can be more ambiguous than those of planned tests performed properly.

The following definitions are presented to clarify several terms used in this chapter and discussed further in Chapter 21:

- **Anomaly** - deviation from the norm; an irregularity. This term is often used in reference to an anomalous pattern in the integrity test measurements. An anomaly may or may not represent a defect in the drilled shaft.
- **Defect (noun)** - a fault or flaw
- **Deficient** - insufficient or inadequate

## 20.2 NON-DESTRUCTIVE INTEGRITY TESTS

The most common NDT methods are summarized in Table 20-1. This section provides an overview of the tests listed in Table 20-1 as well as other less common tests. These tests generally require expert knowledge for performance and interpretation. Technician-level expertise is required for conducting the field tests, while interpretation of results should be done by a qualified engineer in consultation with the project geotechnical engineer. Most of these tests also require specialized software for data acquisition and processing. When a transportation agency employs one or more of these tests, it should do so with its own employees who have been trained in the performance and interpretation of the test or it should employ a qualified outside firm. It is also common in U.S. practice for NDT/NDE to be included in the construction contract, in which case the contractor is responsible for hiring a qualified firm to conduct and interpret the tests. While this approach often works well, it can raise difficult questions when a dispute arises over anomalous readings and their interpretation. If the NDE firm is under contract to the foundation contractor, it is not clear whether they are representing the interests of the contractor or the transportation agency.

**TABLE 20-1 COMMON NDT METHODS FOR DRILLED SHAFTS**

<b>Test Feature:</b>	<b>Crosshole Sonic Logging (CSL)</b>	<b>Gamma-Gamma</b>	<b>Sonic Echo/Impulse Response (SE/IR)</b>
<b>ASTM Standard</b>	D 6760	None	D 5882
<b>Basic Concept</b>	Acoustic signals generated in embedded access tubes are measured in adjacent tubes, providing evaluation of concrete quality between the tubes	Gamma rays emitted from a source are backscattered by concrete and measured by a detector; measured gamma ray counts correlate to concrete density; source and detector are located in a single probe lowered into access tubes	Generate stress wave at the head of the shaft; measure wave reflections to assess shaft length and potential defects
<b>Primary Application</b>	Assessment of concrete quality inside the reinforcing cage	Assessment of concrete quality around the perimeter of the shaft	Verification of shaft length; crude tool for identifying potential defects
<b>Limitations</b>	Difficulty locating defects outside the line of sight between tubes; Tubes must be installed prior to concrete placement	Difficulty locating defects > 4 inches away from tubes; Readings complicated by rebar nearby; Tubes must be installed prior to concrete placement; Need to handle, transport, and store radioactive materials	Effective depth limited by stiff soil or rock; difficulty locating small or thin defects; shadow effect
<b>Advantages</b>	Relatively accurate and relatively low cost	Relatively accurate and relatively low cost	Low cost; Rapid data acquisition; can accommodate unplanned evaluations
<b>Variations and Related Tests</b>	Cross-Hole Tomography; Perimeter Sonic Logging; Single Hole Sonic Logging		Bending Wave; Parallel Seismic; Internal Stress Wave

### 20.2.1 Sonic Methods

Crosshole Sonic Logging The Crosshole Sonic Logging (CSL) method is currently the most widely used test for quality assurance of drilled shaft concrete. A schematic of the method is shown in Table 20-1. Vertical access tubes are cast into the shaft during construction. The tubes are normally placed inside the rebar cage and must be filled with water to facilitate the transmission of high frequency compressional sonic waves. An acoustic transmitter (T) is lowered to the bottom of one access tube and a receiver probe (R) is lowered to the



same depth in one of the other tubes. The transmitter emits an acoustic impulse at an assigned frequency, usually 30 to 50 kHz. The signal travels through the concrete and is picked up by the receiver. The probe cables are pulled upward simultaneously such that the transmitter and receiver probes are always at the same elevation (zero-offset). Logging involves measuring and recording the emitted and received signals at specified increments of depth (typically 2 inches). The ability to obtain acoustic profiles between multiple pairs of tubes makes it possible to characterize the position of an anomaly relative to the centerline of the shaft. Analysis of multiple profiles can also provide an idea of the size of a potential defect. These features, combined with low to moderate cost, are the primary advantages of CSL testing.

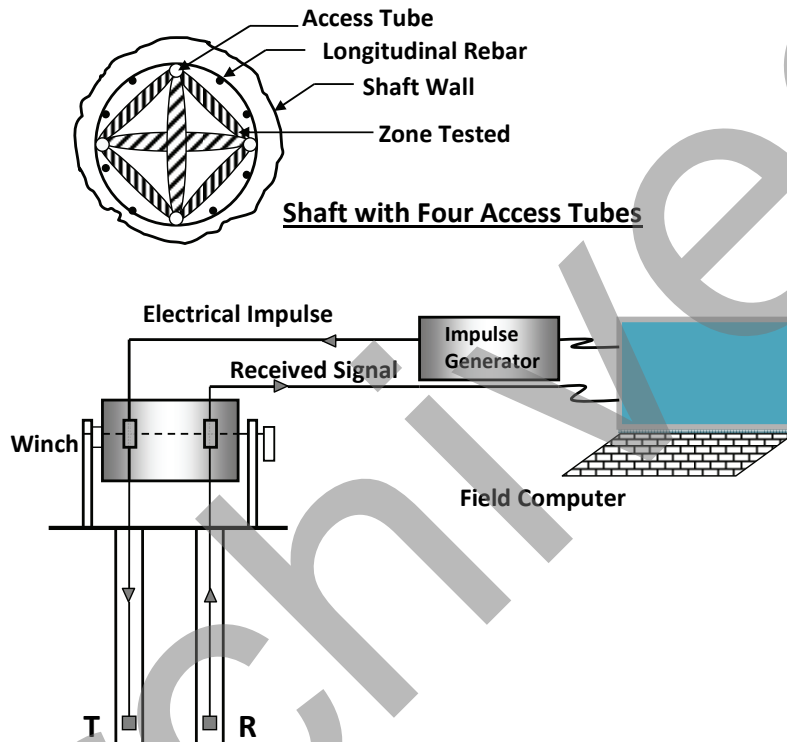


Figure 20-1 Diagram of Crosshole Acoustic Logging System (modified after Weltman, 1977)

Integrity of the concrete between source and receiver is evaluated on the basis of two test results: signal velocity and signal strength. Velocity is calculated by  $V = (d/t)$ , where  $V$  = velocity,  $d$  = center to center spacing between tubes, and  $t$  = measured travel time (first arrival time, or FAT). Signal strength is typically evaluated in terms of relative energy, obtained by integrating the absolute value of the signal amplitude for a defined time period, and expressed in units of decibals (dB). Strong anomalies in travel time (or velocity), combined with decreased signal strength, are interpreted as potential defects (flaws).

The computed velocity of the acoustic signal is compared to the theoretical velocity of a compressional wave through concrete, given by:

$$V_c = \sqrt{\frac{\alpha E}{\rho}} \quad 20-1$$

$$\alpha = \frac{1 - \nu}{(1 + \nu)(1 - 2\nu)} \quad 20-2$$

$$\rho = \frac{\gamma}{g} \quad 20-3$$

where:

- V = theoretical compressional wave velocity in concrete
- E = modulus of elasticity
- $\nu$  = Poissons ratio
- $\rho$  = mass density of concrete (mass/unit volume)
- $\gamma$  = unit weight of concrete, and
- G = acceleration due to gravity (32.2 ft/sec<sup>2</sup>)

Using properties of concrete with compressive strengths in the typical range of 3,000 to 5,000 psi, Equation 20-1 yields  $V_c = 10,000$  ft/sec to 11,500 ft/second, respectively. However, velocity is also affected by frequency, and experience demonstrates that normal quality concrete will exhibit sonic velocities close to an average value of 13,000 ft/sec. This value is often used as a baseline velocity against which CSL measured velocities are evaluated. Alternatively, some of the signal processing software now available will compute a running average of velocity over a specified depth interval (typically 10 to 12 ft) and compare individual readings to this baseline. The degree to which the measured velocity deviates from the baseline value can be given in terms of a velocity reduction (VR), expressed as a percentage:

$$VR = \left(1 - \frac{V}{V_b}\right) 100\% \approx \left(1 - \frac{V}{13,000}\right) 100\% \quad 20-4$$

in which  $V_b$  = baseline velocity (assumed to be 13,000 ft/sec above for illustrative purposes). In contrast to concrete, the sonic velocity in water is approximately 5,000 ft/sec and in air is approximately 1,000 ft/sec. A qualitative rating of the concrete condition, based on VR% and the degree of energy reduction in the received signal, is given in Table 20-2.

Figure 20-2 shows an example CSL profile based on measurements made in a single tube combination. The left side of the figure shows the computed wave velocity (heavy line) and the relative energy (thin line) plotted on a log-energy graph, with lower values to the right. The right side of Figure 20-2 is a 'waterfall diagram', obtained by nesting of signal arrival times versus depth measurements. ASTM Standard D6760 (ASTM, 2002) recommends that the waterfall diagram be included with the reported results of CSL tests. The left edge of the waterfall diagram represents the first arrival time, or FAT, and depths of low intensity, such as at depths of 1, 7, and 10.5 m (3, 22, and 35 ft), indicate decreased signal strength. The relative velocity decreases at the three depths noted above are 29, 28, and 12 percent, respectively, and the corresponding energy reductions are 7.3, 9.4, and 7.5 dB. Based on the criteria of Table 20-2, the anomalies at depths of 1 m and 7 m would be rated P/D (poor/defective concrete) and the anomaly at a depth of 10.5 m would be rated Q (questionable quality concrete).

**TABLE 20-2 CONCRETE CONDITION RATING CRITERIA**

Velocity Reduction, VR (%)	Signal Distortion/Strength	Concrete Rating	Indicated Conditions
0 – 10	none/normal energy reduction $\leq 6$ dB	Good (G)	Acceptable quality concrete
10 – 20	minor/lower energy reduction 6.1 to 9 dB	Questionable (Q)	Minor contamination, intrusion, or questionable quality concrete
> 20	severe/much lower energy reduction > 9 dB	Poor/defect (P/D)	contamination, intrusion, and/or poor quality concrete
No signal	None	No Signal (NS)	Intrusion or severe defect; could also be caused by tube debonding
$\approx 60$	severe/much lower energy reduction $\geq 12$ dB	Water (W)	water intrusion or water-filled gravel intrusion with few or no fines

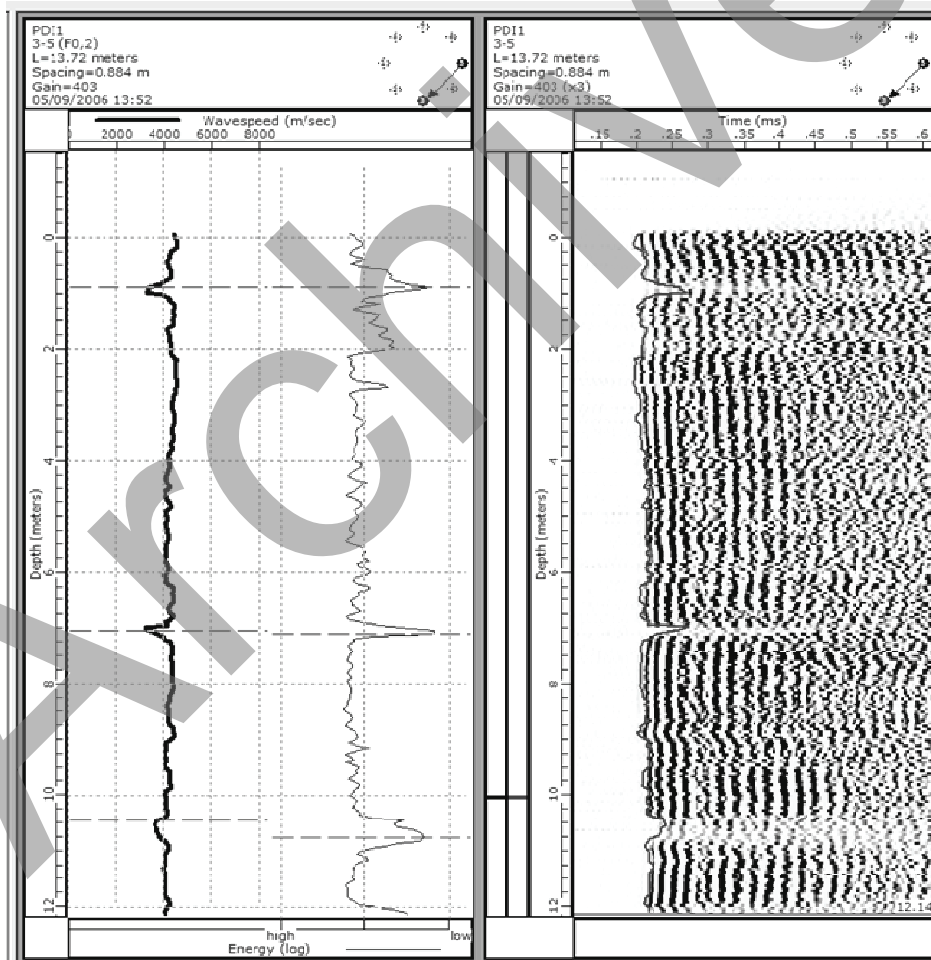


Figure 20-2 Crosshole Sonic Log for a Drilled Shaft with Known Inclusions (Likens et al., 2007) (1 m = 3.281 ft)

The size of anomaly or defect that can be detected by CSL decreases with increasing frequency of the emitted signal. Theoretically, the smallest defect that can be reasonably detected is about one-fourth of the wave length of the transmitted acoustic signal. However, experimental studies on full-scale drilled shafts suggest that additional factors limit the size of a defect that can be detected by CSL. Amir and Amir (2009), based on a review of the literature and on field testing of a drilled shaft with known inclusions, concluded that a defect located halfway between two access tubes is detectable only if its size exceeds about one third of the tube spacing or about 10 percent of the shaft cross section. They also note that an anomalous signal created by a defect depends not only on the size of the defect, but also on its location. The closer a defect is to an access tube, the larger it appears in 2-D or 3-D tomography (described below).

Access tubes for CSL typically are Schedule 40 steel or PVC with a 1.5 to 2-inch inner diameter to accommodate the probes. The tubes are attached to the inside of the rebar cage and normally extend the full length of the drilled shaft. The tubes are plugged on their lower ends to keep out concrete. A rule of thumb is to place the access tubes uniformly around the cage, using one longitudinal access tube for each foot of shaft diameter. At least two tubes are installed. It is important for the tubes to be vertical and at a constant spacing over their entire length so that measured differences in travel time of sonic signals do not occur as a result of differences in tube spacing, which could lead to incorrect interpretation of test results.

PVC tubes can accommodate both CSL tests and gamma-gamma tests. However, PVC tubes tend to de-bond from the concrete more quickly than steel and it is necessary to perform CSL testing within a few days of casting the shaft. Steel tubes will resist de-bonding for a longer time period (typically at least two weeks), providing more flexibility in terms of when the tests are conducted. However, metal tubes are not considered suitable for gamma-gamma testing without being calibrated for the specific tubes. Regardless of the material, tubes for CSL testing must be filled with water so the acoustic signal can be transmitted from the wall of the tube into the probes and vice versa. Water also helps to maintain temperature equilibrium between the tubes and the concrete, inhibiting the tendency for de-bonding from the concrete due to differential thermal expansion and contraction. A recommended practice is to fill the tubes with water prior to concrete placement to assist in resisting buoyancy forces from the fluid concrete. Filling the tubes with water also maintains temperature equilibrium during concrete curing. A reinforcing cage with steel access tubes mounted on the inside of the cage is shown in Figure 20-3.

Initially, the tube pairs to be tested should include at least all perimeter pairs and the main diagonals. If an anomaly is detected, all of the possible pairs of tubes should be tested.

Access tubes installed for CSL or other NDT methods can also be used for coring the base of a drilled shaft to investigate the quality of the base contact. The tubes can also be used for post-grouting at the base if such an action becomes necessary. For these applications, it is advisable to use PVC or other plastic caps at the bottom of the access tubes, which are easy to drill out (Figure 20-3).

Crosshole Tomography: The Crosshole Tomography (CT) method is based on the same principles as CSL and utilizes the same equipment and access tubes. CT differs from conventional CSL in the way measurements are obtained and in processing of the data. Measurements are made for a larger number of transmitter-receiver locations, including measurements for which the transmitter and receiver are at different elevations (vertical offset). For example, as shown in Figure 20-4, the receiver probe can be positioned at a fixed elevation in one tube, while the transmitter elevation is varied in one of the other tubes. Measurements are made for numerous combinations of vertical offset and for all possible tube combinations. It is typical for measurements in a single shaft to involve tens or hundreds of transmitter-receiver combinations, resulting in the generation of data for thousands of ray paths.

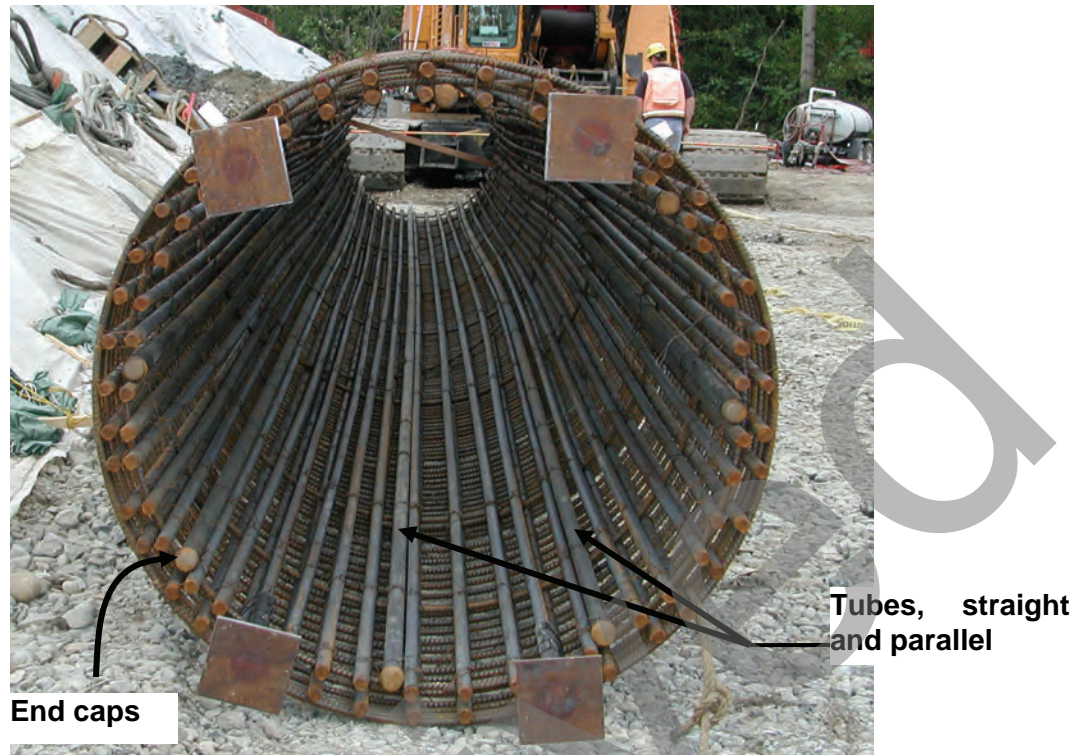


Figure 20-3 Reinforcing Cage with Steel Access Tubes for CSL Testing

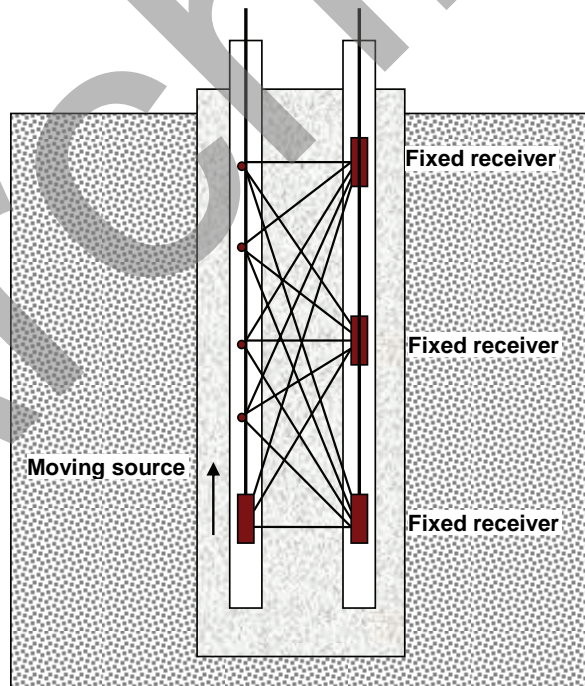


Figure 20-4 Crosshole Tomography Test (after Hollema and Olson, 2002)

Data generated by CT measurements are analyzed numerically, using a matrix inversion procedure, to generate two- or three-dimensional images of signal velocity, referred to as tomograms. Specialized computer software is required for this type of analysis. A 2-D tomogram is either a vertical or horizontal slice of the drilled shaft between the respective tube pairs showing the measured wave velocities as color contours. Figure 20-5 shows examples of 2-D vertical slices produced by CT testing of a shaft with four access tubes (Hollema and Olson, 2002; Olson, 2005). The tomograms shown correspond to tube combinations 2-3, 3-4, 1-3, and 2-4. Color contours were selected to show sound concrete in green and potentially defective materials in red, orange, and yellow. The perimeter tomograms (2-3 and 3-4) show pronounced zones of low-velocity material, indicating weaker concrete or soil inclusions. A horizontal slice, or 2-D tomogram of the shaft cross-section, is better at showing the lateral extent of an anomaly and can be used to determine where coring might be conducted or to aid in remediation efforts. Tomography results can also be presented in 3-D body diagrams.

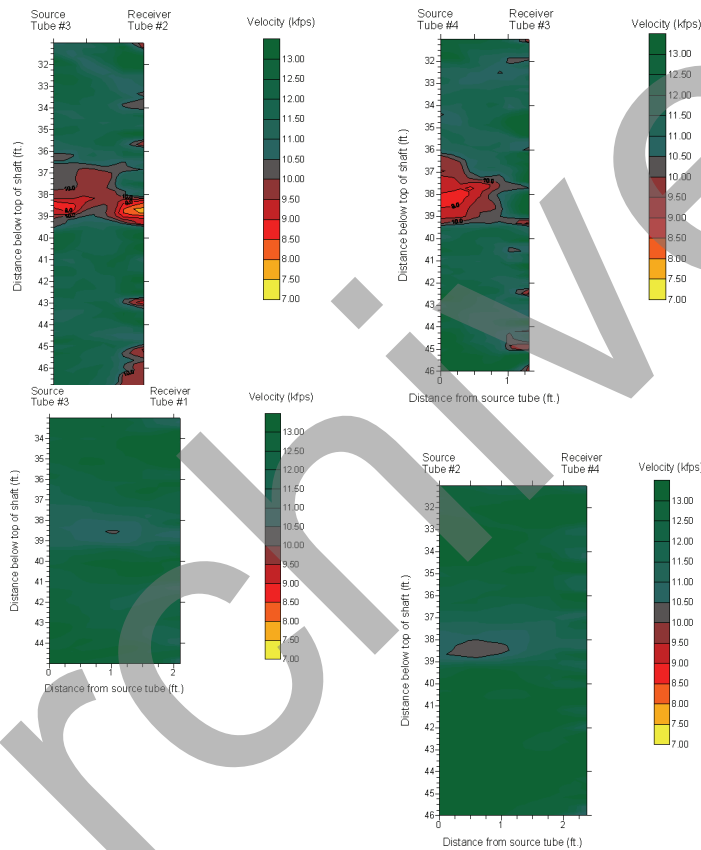


Figure 20-5 2-D Tomograms for a Shaft with Four Access Tubes (Hollema and Olson, 2002)

CT methods are more time consuming and expensive than CSL testing. A rational approach is to conduct CSL testing for routine quality assurance. When CSL results indicate anomalous velocity or energy readings, in which VR values exceed 20 percent, CT methods provide a means to characterize further the size and nature of the anomaly. For example, the CT tomograms shown in Figure 20-5 were developed as a result of CSL tests on a drilled shaft that showed velocity anomalies at depths between 36 and 39 ft from the top of the shaft. The CSL anomalies were observed in the access tube pairs identified above (2-3 and 3-4) and showed velocity reductions in the range  $VR = 14$  to 26 percent (Hollema and Olson, 2002). This type of approach provides owners, engineers, and contractors with information needed to assess the consequences of the potential defects on drilled shaft performance and in making better-informed decisions about further tests, such as coring, and remediation methods.

An efficient approach to CT testing involves using the normal CSL equipment, consisting of one transmitter probe and one receiver probe. The probes are placed in the parallel access tubes in the normal manner and data collected first with the probes at zero offset. A protocol is established so that if an anomaly is detected, offset scans are carried out, first with the transmitter higher than the receiver and then again with the receiver higher than the transmitter. This provides a total of three scans at each depth, per pair of access tubes. In most cases this provides a sufficient number of crossing paths through the center to determine the extent and location of any defect in the center core. Using this protocol saves time and money by avoiding additional follow-up CT testing and the associated mobilization costs.

**Perimeter Sonic Logging (PSL):** Perimeter sonic logging is the application of cross-hole sonic logging methods with access tubes placed outside the rebar cage. The intent is to evaluate the integrity of concrete around the perimeter of the reinforcing cage. Samtani et al. (2005) describe the results of PSL testing on twenty drilled shafts constructed under polymer slurry in Tucson, where concrete conditions around the perimeter of the shafts were of concern. Numerous anomalies were indicated by the PSL results and test shafts were exposed to confirm the anomalies. The authors report that each suspected anomaly was verified, validating the method as a useful NDE tool. The authors also report that sonic velocities from PSL measurements differ from CSL measurements between tubes located inside the reinforcing cage and exhibit more “noise” than standard CSL measurements. At this time, PSL is a method that appears promising but requires further research and development. A practical issue to consider is that tubes on the outside of the rebar cage are difficult to protect during cage placement.

**Single Hole Sonic Logging (SSL):** This method, another variation on sonic logging, involves placing the sonic transmitter and receiver probes in the same access tube. The test is performed while pulling both probes upward at the same rate, maintaining a constant vertical spacing between the probes. Ultrasonic pulses are transmitted at a specified depth interval (e.g., 0.5 inch) and the arrival time, signal strength, and pulse shape are all recorded as a function of depth, similar to CSL. As reported by Amir (2002), this method is effective in identifying anomalies within a radius of approximately 3 inches from the tube, and possibly further for thick defects. However, the results are affected by factors such as tube diameter, probe spacing, and tube material (PVC is required). This method, which is currently under development, may be more applicable to small-diameter shafts, micropiles, or auger-cast piles, where multiple access tubes are not practical, than to most drilled shafts.

### 20.2.2 Gamma-Gamma Method

The Gamma-Gamma Logging (GGL) method is based on measurements of the rate at which gamma particles (photons) emitted from a source travel through concrete, and are measured by a gamma-ray detector. The source and detector are located in a single probe, as shown in Figure 20-6. The probe is lowered to the bottom of a PVC access tube. Gamma rays are emitted from the radioactive source (Cesium-137) while the probe is retrieved at a constant rate. Logging consists of measuring the rate at which photons are detected by a NaI scintillation crystal in the detector. The measured detection rates are referred to as ‘gamma ray counts’ and are recorded in counts per second or *cps*. Gamma ray counts depend upon the transmission path, the degree of gamma-ray scattering, and gamma-ray absorption. Scattering and absorption depend upon the electron density of the medium surrounding the probe and can be correlated to average mass density of the medium. For concrete, there is a reasonably linear relationship between mass density (or unit weight in  $\text{lb}/\text{ft}^3$ ) and the natural log of the gamma ray counts in *cps*.

The radius of influence of a GGL probe is governed approximately by one-half the vertical spacing between source and detector, and the strength of the gamma ray source. For a low energy (10 millicurie) source with a 6 to 8-inch source-detector spacing, the effective radius of penetration is approximately 2 to 3 inches, while a higher energy (100 millicurie) source with a 12 to 18-inch source-detector spacing provides approximately 6 to 8 inches of

penetration. Accounting for the diameter of the access tube (typically 2 inches), the gamma/gamma log will provide density information for a relatively small cylinder of concrete concentric with the tube. Probe characteristics vary between manufacturers, and each probe must be calibrated to establish the relationship between gamma ray counts and concrete density ( $\text{lb}/\text{ft}^3$ ).

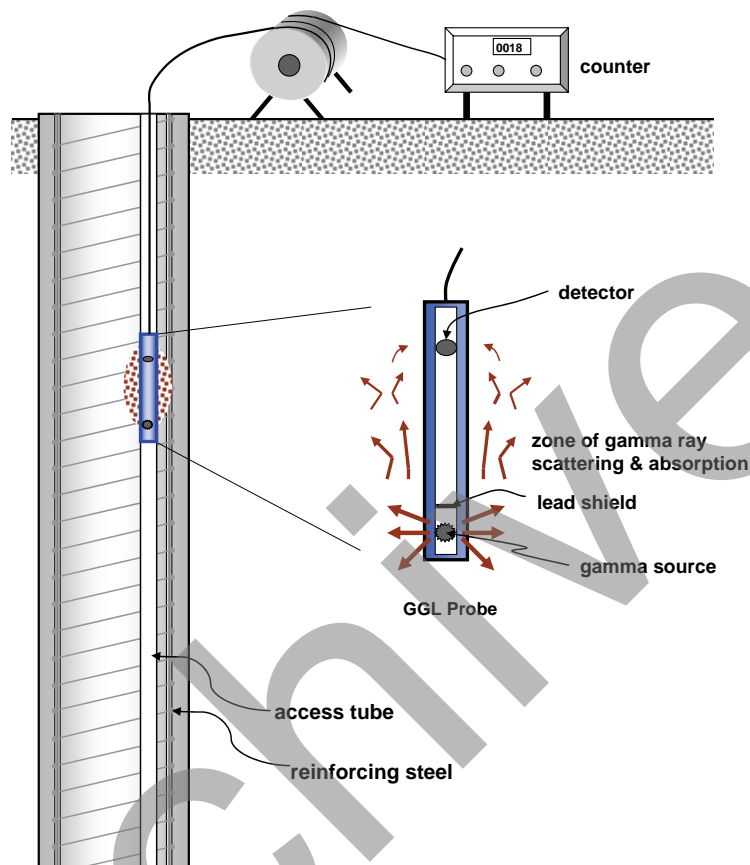


Figure 20-6 Gamma-Gamma Logging (GGL) in a Drilled Shaft

The GGL method for drilled shafts provides a means to evaluate the uniformity of concrete density in a zone adjacent to each tube. Access tubes can be placed on the inside or outside of the reinforcement cage, but normally are placed inside the cage where it is easier to protect the tubes from damage or displacement when the cage is being handled and placed in the borehole. Tubes are placed at a constant distance from the longitudinal reinforcing bars that is sufficient to minimize the influence of the steel on the measured gamma-ray counts, but which enables the measurements to capture anomalies in the zone of concrete coverage. Figure 20-7 shows a cradle used to fix access tubes on the inside of a reinforcing cage to provide a 3-inch spacing. The specified clear spacing (3 inches) is approximately the radius of influence for the GGL probe, providing a measurement of concrete density in a zone that reaches to the inside perimeter of the cage, thus providing measurements in the very important zone of concrete coverage. Tubes also must be located a sufficient distance from the outside perimeter of the shaft to avoid detecting changes in the density of the soil or rock exterior to the shaft concrete. This requirement also favors the placement of the tubes inside the reinforcement cage.





Figure 20-7 Placement of PVC Access Tube Inside Reinforcing Cage

Evaluation of concrete uniformity is accomplished by defining anomalies in terms of deviations in the measured density. If it is assumed that concrete density follows a normal (Gaussian) distribution, the probability that a density measurement will be three standard deviations below the mean is 1.35 percent. This probability is considered sufficiently low that GGL density measurements less than three standard deviations below the mean are considered anomalous. To illustrate the application of this concept in practice, Figure 20-8 shows typical results from GGL testing on a drilled shaft with four access tubes within a 4-ft diameter cage. The graph shows density on the horizontal axis versus depth on the vertical axis. The mean density from all data points within the shaft is computed and shown on the graph as a vertical trend line. The standard deviation ( $\sigma$ ) is calculated and a line corresponding to  $3\sigma$  below the mean is also shown on the graph. Any location where the measured value of density in any of the tubes is less than  $(\text{mean} - 3\sigma)$  is defined as anomalous. Some agencies use criteria based on the mean and standard deviation of GGL measurements in each individual access tube, while others group all of the measurements in a single shaft (e.g., as described above for Figure 20-8). There is currently no ASTM standard method for GGL testing and data analysis.

The shaft of Figure 20-8 was installed under slurry. The gamma-gamma log shows anomalous readings near the base of the shaft, possibly because of mixing of slurry or sediment with the concrete. For this particular shaft, the possible contamination of concrete near the base was not judged to be severe enough to warrant consideration. However, there is a zone higher up the shaft, where a marked reduction in concrete density occurs in two of the four tubes. Additional investigation showed defective concrete at this depth, much like the defect shown in Figure 20-9. In fact, in Figure 20-9, a white PVC access tube for GGL testing is visible.

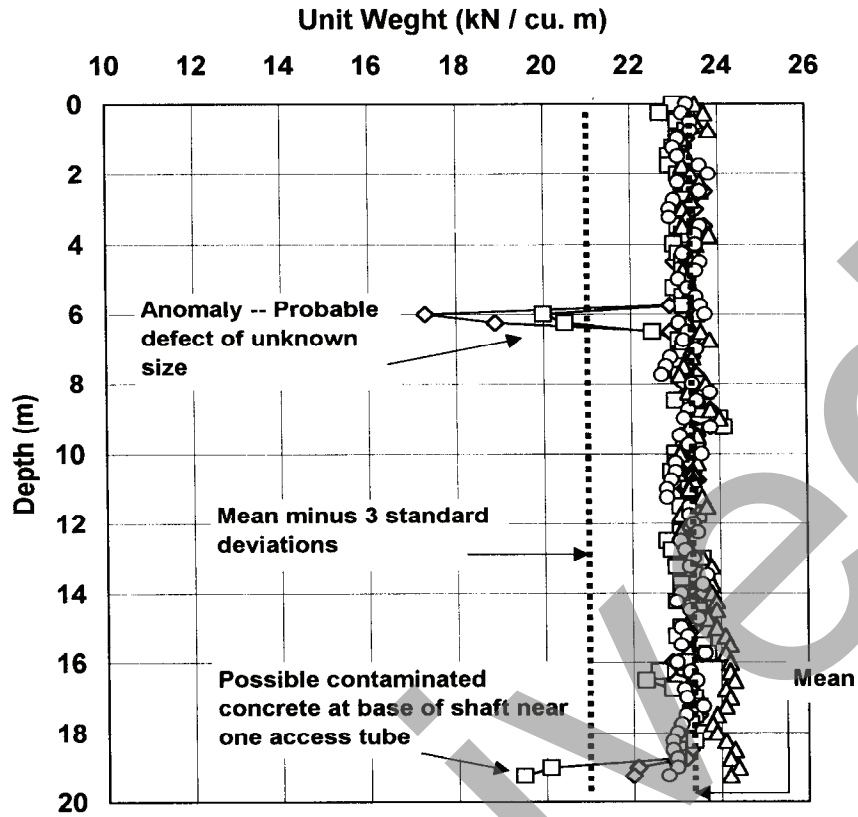


Figure 20-8 Results from Gamma-Gamma Logging of a Drilled Shaft with Four Access Tubes (Courtesy of Caltrans); 1 m = 3.281 ft., 1 kN = 224.8 lb.



Figure 20-9 Defect Similar to the Defect that Produced the Logs in Figure 20-8 (Courtesy of Caltrans)

Several features of drilled shaft reinforcing cages and access tubes may affect GGL density measurements, but are not related to concrete density. For example, the distance between the access tubes and the steel reinforcing must be uniform along the length of the tubes so the effect of steel on the measured density is consistent. Readings will also be affected by couplers at the PVC tube joints, which may appear as minor anomalies in density. For proper interpretation, the contractor or testing agency should provide a log indicating the elevation of couplers. Since couplers typically are at 20-ft intervals, their locations should be easy to recognize. Other features that may affect GGL readings include changes in the reinforcement schedule, the presence of instrumentation or load cells, and ties or any other fixtures attached to the reinforcement. In soft soils, the plastic wheels used to center the cage could penetrate the sidewall soil, which may show up as an anomalous reading. It is important to document the location of all such features.

GGL readings are reliable and repeatable, and they are not affected by jobsite ambient vibrations, electrical interference, or by debonding of the access tubes. Data processing is relatively straightforward and there are no limitations on depth. The method is effective in identifying defects that occur within several inches of the access tubes. The primary application of GGL is in detecting anomalies and defects in the concrete coverage zone for the steel reinforcing cage. Anomalies in this zone are often the result of soil caving or poor concrete flow through the rebar cage. These can be critical defects because they expose the steel reinforcement to corrosion. According to Caltrans (2010), the time required to conduct GGL testing depends on the size of the drilled shaft. Each inspection tube is logged once, and a drilled shaft roughly has one tube per foot of shaft diameter. During logging, a GGL probe is raised at a rate between 10 and 12 ft per minute. A typical 6-ft diameter, 100-ft long shaft requires approximately 2 hours to conduct logging, excluding analysis time.

GGL testing has several limitations. The zone of concrete that is tested is a relatively small portion of the shaft cross section and does not extend to the interior of the shaft. When the tubes are placed inside the reinforcing cage, which is the most common location, GGL may not detect anomalies or defects in areas outside of the cage if they do not penetrate to the outside perimeter of the reinforcement cage. The method is not effective for identifying the lateral extent of an anomaly, a capability that is better suited to CSL testing, including tomographic methods. Proper alignment of the PVC tubes requires care during construction to ensure tubes are straight and undamaged. The probe contains radioactive material which requires licensing and compliance with Nuclear Regulatory Commission (NRC) regulations, including those applicable to transportation of the equipment.

### **20.2.3 Methods Based on Analysis of Stress Waves**

The tests included in this group are the Sonic Echo (SE) and Impulse Response (IR) methods. Variations of the SE test include the Bending Wave and Parallel Seismic tests. All of these methods involve the generation of low-amplitude stress waves at the top of the shaft. Properties of the shaft concrete are inferred from measured reflections and travel times of the stress waves. Both the SE and IR tests require an impulse hammer and a motion sensor (either a geophone or an accelerometer) positioned at the head of the shaft, as illustrated in Figure 20-10. An operator strikes the top of the shaft with the hammer, generating a compressional stress wave that travels down the shaft at velocities in the sonic range. Wave energy is reflected at any location at which there is a change in impedance, for example at the base of the shaft. The reflected wave travels back up the shaft where it is detected by the motion sensor. Impedance, or resistance to wave propagation, is a function of the shaft cross-sectional area, wave propagation velocity, and mass density of the concrete. Defects or irregularities in a drilled shaft, such as soil intrusions, changes in concrete density, or any change in the shaft dimensions, will change the impedance and result in reflection of wave energy. Identification and interpretation of wave reflection signals (echoes) form the basis of these methods. The difference between SE and IR methods pertains primarily to the techniques used to process the test

measurements. Test results are analyzed in the time domain for the SE method and in the frequency domain for the IR method.

### Sonic Echo (SE) Method

The SE method is illustrated in Figure 20-10. Waves reflected from irregularities and/or the base of the drilled shaft are detected by the accelerometer (receiver). A signal analyzer is used to process and display the hammer and receiver signals as a function of time. The figure illustrates an ideal case where a single reflection from the base is recorded. Digital filtering is usually applied to eliminate high frequency noise and unwanted reflections from the sides of the shaft. Changes in impedance are inferred by identifying and analyzing the arrival times, direction, and amplitude of the reflected signals. For example, for the case illustrated in Figure 20-10, the as-built length of the drilled shaft is found from the simple equivalence shown in the figure and knowledge of the velocity of the compressional wave in concrete,  $V_c$ .

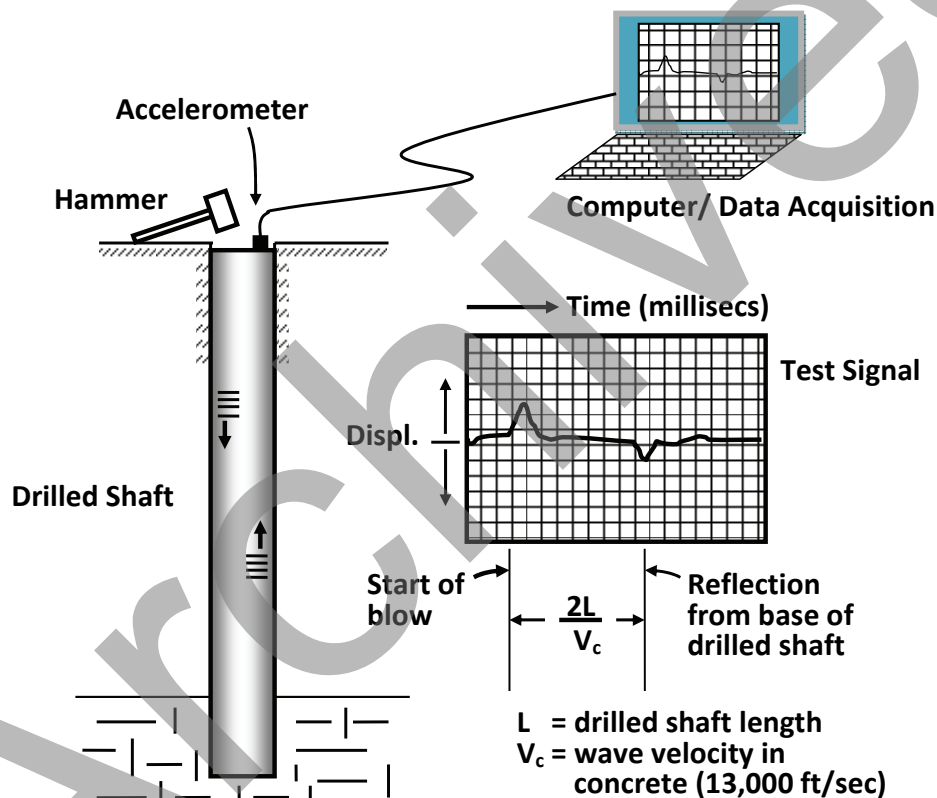


Figure 20-10 Sonic Echo Method (after Sliwinski and Fleming, 1983)

Evaluation of drilled shaft integrity from SE tests requires interpretation of the reflected wave signals based on the following principles:

- Potential causes of an impedance decrease include soil intrusions, honeycomb or otherwise low density concrete, cold joints or breaks in the shaft, and decreases in the cross-sectional area of concrete;
- A reflection that indicates an impedance decrease is sometimes referred to as a “neck”, regardless of its underlying cause;

- Impedance increases may occur due to an increase in shaft diameter or increases in the competency of the surrounding soil or rock, and are often referred to as a “bulb”. In general, a bulb is not interpreted as a potential defect.

Identification of a neck does not, by itself, provide definitive proof of a defect in a drilled shaft, nor does it provide a means to determine exactly which property of the shaft has caused the decrease in impedance. For this reason, reflections other than those caused by the base of the shaft should be identified as anomalies. It is then up to the engineer to decide whether a detected anomaly represents a potential defect. Independent observations made during construction provide the additional evidence needed to classify an anomaly as a potential defect. For example, if the anomalous reading (neck) corresponds to a depth at which caving was observed or a concrete underpour occurred (based on concrete volume monitoring), this information in combination with the anomalous SE signal would suggest a potential defect. In addition, the interpreter of the SE test must be familiar with its limitations, as follows:

- The strength of the echo depends on the surrounding soil or rock. For this reason the interpreter of a sonic echo or similar test (impulse-response, impedance logs) must have access to the boring data and be familiar with the subsurface conditions at the site of the test shaft.
- Echoes are frequently too weak to be distinguished when drilled shaft length to diameter ratios exceed approximately 10:1 in rock, 20:1 in stiff or hard soils, 40:1 in medium-stiff soils, or 60:1 in very soft soils.
- The reflection (echo) from the base of a drilled shaft in rock may be weak, especially if there is a clean contact between the concrete and rock.
- The smallest size of detectable anomalies is approximately 10 percent of the drilled shaft cross-section. Baker et al. (1993) concluded from an extensive experimental study that surface techniques such as SE were not reliable in identifying defects that covered less than about 50 percent of the shaft cross-sectional area. However, an updated study by Iskander et al. (2001) showed that advances in data acquisition equipment and analysis software, as well as improvements in the skill of testing firms who have appropriate experience, led to significant improvements in the ability of surface methods to detect smaller anomalies. Experienced operators were able to identify built-in defects down to 10 percent of the cross-sectional area of the shaft.
- The geometry of a defect (percentage of the cross section, thickness, and position within the cross section) generally cannot be determined. However, in larger-diameter shafts, the test can be conducted in several locations around the top of the shaft, making it possible to identify and locate reflections occurring in limited portions of the cross-section over a depth of several diameters (3 to 5) from the top of the shaft. Often this is a critical zone for defects, especially for shafts under lateral loading.
- Defects located below the uppermost major defect exhibit weaker reflections (shadow effect) and the ability to identify multiple defects is limited; a major defect will make it impossible to detect anything below it.
- Defects at or near the shaft base cannot generally be identified because of the uncertainty in the material wave speed and the inability to distinguish between a reflection from a normal base and a reflection caused by a defect in the same location.
- Planned or unplanned diameter changes can appear as anomalies even if the diameter is acceptable; for example, a reflection will appear at the change in diameter between the cased portion of a shaft above rock and the uncased portion below top of rock.
- Impedance changes in response to a change in concrete modulus or density can be caused by slurry contamination or honeycombing in the concrete. However, a similar effect can also result from

changing ready mix trucks during a concrete pour in which the modulus and/or density change. Although detectable, this type of anomaly does not constitute a structural defect.

It may be possible in some cases to simulate the size, location, and nature of a defect using a one-dimensional wave equation program. The size, position, and stiffness of the defect are varied in the computer code in order to match the computed velocity time history at the head of the shaft with that measured by the test. As described by Middendorp and Verbeek (2005), this simulation sometimes allows for a better understanding of the possible properties of the defect. However, the "curve matching" procedures are not unique.

In summary, the sonic echo test should be considered as a screening method that is capable of locating defects covering at least 10 percent of the cross section, such as voids or soil inclusions, and bases of shafts that were drilled to the wrong depth. The kind of internal defect that the SE test is likely to detect with a high degree of certainty is shown in Figure 20-11. In this shaft, the contractor worked under a specification that did not allow the use of slurry, and severe sloughing of the sides of the borehole evidently occurred while the concrete was being placed.



Figure 20-11 A Severe Defect Likely to be Detected by Sonic Echo Testing

Sonic echo and other methods based on analysis of stress wave reflections were used widely in the early years of NDT for drilled shafts, but have since been largely replaced by cross hole sonic logging (CSL) and gamma-gamma logging (GGL) as tools for routine quality assurance. However, the method is still useful for investigating potential defects in shafts that exhibit unexpected post-construction performance problems (*e.g.*, excess settlement) but which are not instrumented with access tubes for CSL or GGL methods. SE can also be used to confirm defects identified by CSL or GGL testing.

**Impulse-Response (IR) Test:** The IR method is similar to the sonic echo test in that a stress wave is generated

by hammer impact at the head of the shaft. The hammer is equipped with a built-in load cell that can measure the force and duration of the impact. The method of processing the test measurements is described, among others, by Finno and Gassman (1998). Both the force and measured velocity readings are transformed to the frequency domain by performing a fast Fourier transform (FFT). The resulting velocity spectrum ( $V$ ) is divided by the force spectrum ( $F$ ). This ratio ( $V/F$ ) is referred to as the “mobility” and is plotted on the vertical axis against vibration frequency, in Hz, on the horizontal axis. The resulting graph, called a mobility plot, is used to evaluate and interpret reflections caused by changes in shaft impedance. Figure 20-12 shows an idealized mobility plot. The following parameters are defined from the plot:  $P$  and  $Q$  = mobilities corresponding to the local maximum and minimum values of the resonant peaks, respectively. The drilled shaft mobility  $N$  is defined as the geometric mean of the height of the resonant peaks in the portion of the mobility curve where the shaft is in resonance. As shown in Figure 20-12, the shaft mobility  $N$  is a function of  $P$  and  $Q$ , and can also be defined theoretically as the inverse of drilled shaft impedance, where impedance is the product of density ( $\rho_c$ ), compression wave velocity in concrete ( $V_c$ ), and cross-sectional area of the drilled shaft ( $A_c$ ).

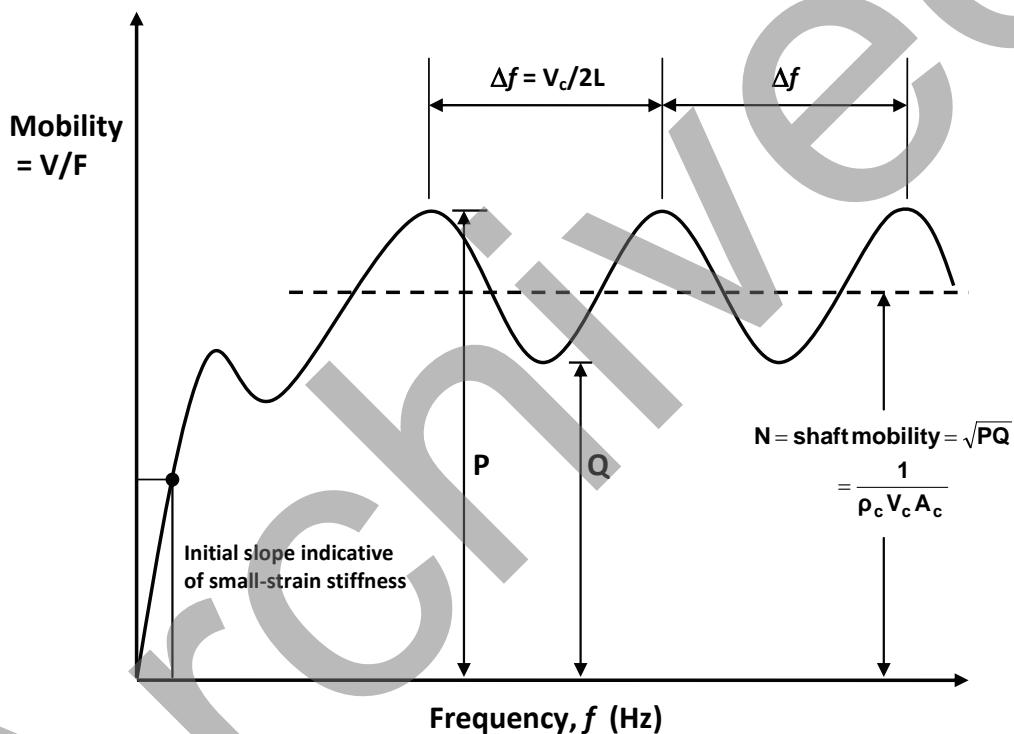


Figure 20-12 Ideal Mobility Plot from Impulse Response Test

The principles applied to the interpretation of mobility plots are as follows. First, the initial slope of the curve is related to the low-strain axial stiffness of the drilled shaft. If the low-strain stiffness is low compared to those of other shafts of the same size and in the same ground conditions that are known to be sound, the reading is anomalous. Second, reflections appear as resonant frequency peaks on the mobility plot. The distance between frequency peaks ( $\Delta f$ ) is controlled by reflections at locations where there is a change in impedance. In Figure 20-12, the reflections are from the base of the shaft, in which case the mobility plot provides a means to determine the as-built length of the shaft using the relationship shown in the figure between frequency change  $\Delta f$ , concrete velocity  $V_c$ , and drilled shaft length  $L$ . If reflections occur at locations other than the base, the relationship shown in the figure can be used to estimate the distance  $Z$  from the geophone to the source of the reflection by Equation 20-5:

$$Z = \frac{V_c}{2\Delta f}$$

Finally, the shaft mobility,  $N$  (dashed line), can be related to the average cross-sectional area of the shaft if values of modulus and density are assumed. If the measured value of  $N$  from the mobility plot is greater than the calculated value, the reading is considered anomalous and a defect could be present. The anomaly could be due to a decreased cross-sectional area ( $A_c$ ) or poor concrete quality causing a decreased density ( $\rho_c$ ) or velocity ( $V_c$ ), or both.

Finno and Gassman (1998) identify some of the factors that can limit the applicability of the IR method for drilled shafts. The capability to locate the base of a drilled shaft is limited by the resolution of the mobility plot. Resolution is defined in terms of the ratio  $P/Q$ . When the  $P/Q$  ratio approaches 1.0 (the minimum and maximum peaks shown in Figure 20-12 are very close), no resonant frequency peaks can be distinguished, and it is therefore not possible to identify reflections whether they come from the base of the shaft or other locations. The  $P/Q$  ratio that can be achieved is shown to depend on the length to diameter ratio of the drilled shaft ( $L/B$ ), the ratio of soil shear wave velocity to propagation velocity of the concrete, and the ratio of soil density to density of the concrete. When these values can be estimated or measured, the user can assess whether the IR method will provide meaningful results for a given drilled shaft and surrounding soil conditions. Further details are given by Finno and Gassman (1998). Under most circumstances, the base of a drilled shaft cannot be identified for  $L/B$  greater than 30.

Certain construction details can affect the mobility plot obtained from IR testing and must be known by the test interpreter to be taken into account properly. This includes features such as the bottom of permanent casing, the presence of loose fill in the annulus between temporary and permanent casing, overexcavation of the drilled shaft, and soil disturbance caused by drilling (Davis and Hertlein, 1991; Finno and Gassman, 1998; Hertlein, 2009).

**Impedance Log:** An impedance log is a two-dimensional representation of a drilled shaft based on signals obtained from IR testing. The measured response from an IR test is compared to the simulated response of an ideal infinitely long drilled shaft in soil. The simulated response is adjusted and scaled based on this comparison, then integrated to produce an impedance log. Details of the numerical analysis are beyond the scope of this manual but the interested reader is referred to Hertlein and Davis (2006) or Gassman and Li (2009). Impedance decreases are represented as equivalent decreases in shaft diameter (a neck), while impedance increases are represented as equivalent increases in shaft diameter (a bulb). Examples of impedance logs are shown in Figure 20-13 (Gassman and Li, 2009). Parts (b) and (c) of the figure show best-estimate and best-fit impedance logs, respectively, for a drilled shaft constructed with a soil-filled joint over the depth interval shown in part (a). Although the images in Figure 20-13 appear to be cross-sections of the shaft, they are not. Calculated cross-sectional areas are plotted as diameters and changes are always shown symmetrically. The user must recognize that the resulting images provide no information on the direction or the location of a potential defect relative to the centerline of the shaft, nor do the images distinguish between anomalies caused by actual cross-sectional changes and those caused by modulus or density changes in the concrete. Several informative case histories are presented by Hertlein (2009) describing the application of IR testing and impedance logs to evaluation of drilled shafts.

**Bending Wave Test:** This test is a variation of the sonic echo method that involves impacting the side of the shaft or the substructure above the head of the shaft, rather than the head, when the top is not accessible (Olson et al., 1995). This method currently has a limited track record for application to routine quality assurance for drilled shafts, but may of interest for evaluating existing structures.



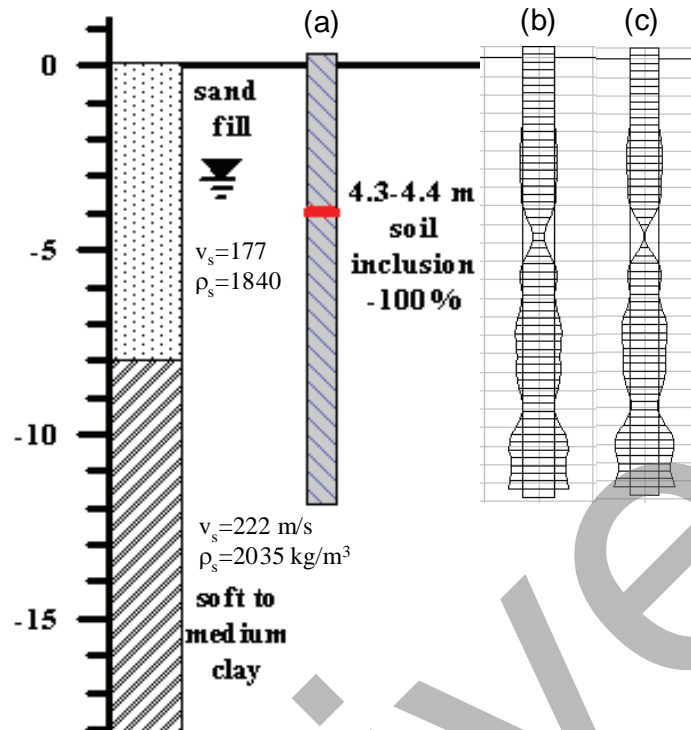


Figure 20-13 Examples of Impedance Logs, Drilled Shaft with Known Inclusion (Gassman and Li, 2009); 1 ft = 0.3 m; 1 lb/ft<sup>3</sup> = 16 kg/m<sup>3</sup>

Parallel Seismic Test: As described by Davis (1995), measurements are made in a vertical access tube installed in the ground adjacent to the drilled shaft. This test is also intended for cases where the top of the shaft, or the top of the cap just above the shaft, is not accessible. A point on the substructure above the shaft is impacted and the propagated wave travels down the shaft. Part of the wave energy in the shaft is transmitted into the soil or rock near the shaft, and its arrival time is measured by a piezo-electric receiver positioned at various depths in the tube. Changes in the arrival rate are interpreted as potential defects. This method is not routine for drilled shafts and the interested reader is referred to Davis (1995).

#### 20.2.4 Thermal Methods

A recently developed non-destructive technique, described by Mullins (2008), is based on measuring the temperature distribution in a drilled shaft during the concrete curing process. The concept of the thermal integrity (TI) method is as follows: the temperature of a drilled shaft increases for a period of time following placement of concrete as a result of heat generated by concrete curing (heat of hydration). If the cross section is uniform, a relatively uniform and symmetrical temperature profile develops. However, if the cross section is not uniform, suggesting a void or soil inclusion, the local temperature will be altered at this location. Measurements showing a non-uniform temperature distribution are therefore considered anomalous. Furthermore, the amount of temperature reduction and the extent over which it exists are used to quantify the size and shape of the anomaly. Similar to all NDT methods, the identification of defects in shaft concrete should only be undertaken as part of a protocol that requires correlation of test results with visual observation and records from rigorous inspection, or subsequent investigation.

TI measurements are conducted as follows. A thermal probe containing four infrared temperature sensors records the internal shaft temperature as it is lowered into standard 1.5-inch or 2-inch I.D. access tubes. The tubes could be those used for CSL testing. A depth-encoded wheel mounted on a tripod at the shaft top records the position of the probe as it is lowered into the access tubes. Measurements are made as the probe descends and a data acquisition system records the field measurements for further processing. For typical drilled shaft concrete mixes, thermal testing should be carried out one to two days following concrete placement.

Integrity evaluation using TI measurements involves modeling the temperature profile of the shaft-soil system and signal matching of the model results to the test measurements. Modeling of the temperature distribution requires information on the concrete mix design and the soil profile in order to predict heat generation and soil insulation parameters. The model predicts shaft temperatures as a function of time. The analysis is based on an inverse method which is described further by Kranc and Mullins (2007).

Experimental results involving construction of test shafts with known defects and comparisons to CSL measurements have been highly successful. The TI method appears to be capable of detecting voids both inside and outside of the reinforcing cage, which is a significant advantage compared to CSL and GGL methods. This method is not currently in use as a production technique, but is undergoing research trials in several states.

### **20.3 DRILLING AND CORING**

A frequent response to concern about the integrity of a particular drilled shaft, usually as a result of a problem observed during placement of the concrete and identified by the inspector, or as a result of significant anomalies noted from non-destructive tests, is to institute a program of drilling and/or coring. Core sampling provides a direct visual examination of concrete and the opportunity to conduct strength tests on as-placed concrete. However, drilling and coring are time-consuming and expensive. Drilling and coring also have limitations that may preclude the visual verification that is needed or desired in every case.

In most cases it is not necessary to core the entire length of the shaft, and drilling is much faster than coring. An effective way to employ a coring program is to limit core sampling to target zones in the shaft where concrete quality is questionable. In zones that are not cored, the quality of concrete can sometimes be inferred from the drilling rate. Drilling may also reveal defects, for example, if a soil-filled cavity is encountered and the drill drops a significant distance.

Coring in the target zone can provide both qualitative and quantitative information on the integrity and quality of drilled shaft concrete. Visual observation of core samples is useful in identifying voids, weak cementation, fractures, soil or slurry intrusions, and other flaws or defects. Reduced core sample recovery may also indicate defective concrete. Intact core samples can be tested for compressive strength. For coring to be effective, high quality cores must be retrieved. It is recommended that cores be recovered utilizing double or triple barrel techniques. Ideally, core diameters for strength tests should be a minimum of four to five times the maximum aggregate size. For mix designs with ½ inch maximum aggregate, NX core is sufficient, but for concrete with maximum aggregate size in the range of ¾ inch to 1 inch, a 4-inch diameter core is preferred for strength testing.

Figure 20-14 illustrates the beneficial application of concrete coring for two cases. In Figure 20-14a, the shaft was cored because samples of concrete that had been taken from the first ready-mix truck that began discharging concrete into the shaft had exhibited a slump of less than 4 inches when the last amount of concrete had been placed. Since the concrete was placed under water by means of a tremie, it was thought that the concrete first placed may have "stuck" within the cage and newer, more fluid concrete may have broken through the low-slump concrete and returned to the surface. With such a scenario, the concrete below

the top of the shaft may have been severely honeycombed or diluted with groundwater. The cores shown in the figure are clearly sound and indicated that this action did not occur. In fact, the temperatures in the ground were low enough to maintain the slump of the concrete in the borehole above 4 inches even though the samples that had been taken from the first truck and held on the surface for later slump testing, where the ambient temperatures were high, indicated that the concrete had lost most of its fluidity.

The cores in Figure 20-14b were taken after constructing a drilled shaft on a batter. Temporary casing was used and when the contractor tried to withdraw the casing it hung on the cage. While the contractor was trying to work the casing free of the cage the concrete began to set up. By the time the casing was recovered, considerable movement of both the cage and the concrete had occurred, which prompted the coring. The recovered core clearly shows defective concrete in the upper 15 ft. The contractor was required to repair this portion of the shaft by replacement of the concrete and repair of the rebar cage.

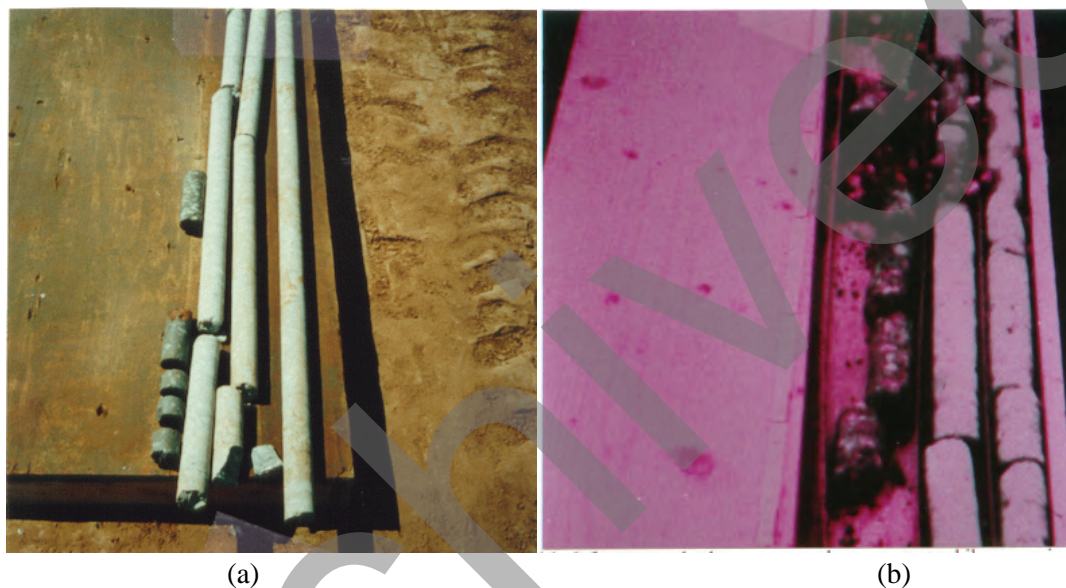


Figure 20-14 Concrete Cores Drilled Shafts; (a) Shaft with No Defect, and (b) Shaft with Defect Caused when Concrete Began to Set while Removing the Casing

Jones and Wu (2005) note that core drilling can be challenging due to access difficulties and in ensuring the target zone is actually drilled. Core drilling typically is performed using small-diameter rotary equipment that is truck or ATV mounted, although portable equipment is sometimes used when drilling is limited to the top few feet of the shaft. Often, more space is required to set up a truck-mounted geotechnical rig compared to the rig used for drilled shaft excavation. This is because the crew must work behind the rig and have at least 10 ft of clear space behind the core hole. Reinforcing steel extending above the shaft creates a difficulty since most rigs cannot clear more than 3 ft vertically. In these cases it may be necessary to raise the ground by placement of fill or to use crane mats or platforms to elevate the rig.

The ability of a concrete core hole to penetrate precisely the target zone of questionable concrete can be limited by the reinforcing steel, NDT access tubes, and the potential for horizontal drift. For example, if the target zone is identified by a CSL anomaly which is limited to the zone between two access tubes or by anomalous GGL readings in the vicinity of a single tube, coring may have limited ability to target these zones. Jones and Wu (2005) indicate that core holes should be located a minimum of 6 inches away from steel reinforcing and steel access tubes to avoid interference while drilling. At least several inches of horizontal drift can be expected in most core holes (and in the drilled shaft as well), and it is not uncommon for the core

hole to run out the side of the drilled shaft or to encounter one or more bars of the reinforcing steel. Experienced personnel are required, along with appropriate equipment, to have greater confidence that the drilling is done correctly in the direction intended.

Given the above limitations, drilling and coring are most effective for identifying and characterizing defects of relatively large size. If the excavation has collapsed during the concrete placement and if the concrete is absent in a section of the shaft (Figure 20-11, for example), the defect is almost always sure to be detected. Smaller defects can easily be missed. The reverse can also be true; that is, coring may reveal a defect that is thought to be severe but in fact is insignificant. For example, coring can reveal weak concrete or sand locally at the base of a rock socket, but sound rock and a good contact could exist across the rest of the socket.

Another procedure that can be employed if a hole has been cored or drilled into the shaft is to pack off a portion of the hole and to perform a fluid pressure test. This procedure is expensive but can be effective in identifying voids or for evaluating the effectiveness of repair procedures. Core or drill holes should be filled with grout or concrete upon completion of sampling if the shaft will be used in a structure.

### **20.3.1 Downhole Video Inspection**

Drilling or coring into drilled shafts, either through access tubes or directly into the concrete, provides the opportunity to employ cameras that can be lowered downhole while providing a video image on a computer or television screen at the surface. A variety of camera types are available for this purpose. The camera shown in Figure 20-15a is used by Caltrans for investigating anomalies and is also well-suited for monitoring drilled shaft repair procedures. The camera is capable of fitting into a 2-inch diameter PVC inspection tube or a core hole and provides real time true color pictures to the surface. One way in which this tool is used is to evaluate the efficacy of repair procedures in which defective materials are removed by high-velocity water jetting (described in Chapter 21). The image shown in Figure 20-15b shows a cavity created by hydro-jetting of defective concrete that was identified by GGL methods. The PVC access tube has also been cut away by jetting in the cavity, enabling the camera to provide images of the repair zone. The image provides visual verification of the cleanout procedure prior to grouting of the void. One thing to consider when using this approach is that jetting destroys not only the PVC pipe, but also any evidence of defects, potentially leaving an argument over whether a defect ever existed.

## **20.4 LOAD TESTING FOR DRILLED SHAFT INTEGRITY EVALUATION**

A field load test on a drilled shaft provides valuable information on some, but not all, aspects of integrity. Successful performance during a load test may verify the geotechnical and structural resistances of a drilled shaft, but only for the specific test conditions and over the relatively short time period of the test. In this sense, any of the load test methods described in Chapter 17 can provide some measure of drilled shaft integrity. A rapid load test, for example Statnamic, provides a means for measuring drilled shaft axial or lateral response without prior installation of instrumentation (*i.e.*, an unplanned test). High-strain dynamic tests, carried out by dropping a heavy weight onto the head of the shaft from various heights, can also be used to evaluate characteristics of stress wave propagation. Drop-weight load testing interpretation relies on analysis methods similar to those used in dynamic pile testing. Strain gauge and accelerometer measurements are made at the top of the shaft. If sufficient shaft resistance is mobilized, it is possible in theory to relate the stress wave characteristics to drilled shaft strength and stiffness utilizing available dynamic testing technologies.

A full-scale static axial or lateral load test to prove drilled shaft resistance may be warranted when a systematic error has been made in the construction of the drilled shafts for a project. This approach is

effective when a definitive test on one shaft would either confirm the acceptance of all of the shafts or show that the systematic error has affected the performance of all of the shafts.

Not all potential defects will be detectable by load testing. For example, a lack of sufficient concrete cover over steel reinforcing may not influence drilled shaft performance during a load test, but could affect the long-term performance of a drilled shaft if the reinforcement undergoes corrosion.



Figure 20-15 Downhole Camera Used by Caltrans (photos courtesy of B. Liebich, Caltrans); (a) Camera; and (b) Image of Void in Drilled Shaft

## 20.5 DESIGN OF AN INTEGRITY TESTING PROGRAM AND ACCEPTANCE CRITERIA

### 20.5.1 When to Use NDT

The first step in this process is for the owner and engineer to decide whether post-construction integrity testing will be incorporated into the project. This is a subjective matter, and will depend upon the individual project and the philosophy of the transportation agency, but some general guidance is presented herein.

The approach recommended in this manual, and one that has been used successfully by several transportation agencies in the U.S., is to require NDE on all drilled shafts constructed using methods that involve placement of concrete under slurry or water (“wet” methods of construction) and on all technique shafts. The philosophy is that placement of concrete under slurry or water makes direct visual inspection difficult or impossible, thus creating greater uncertainty about concrete integrity. The risk associated with this higher level of uncertainty is addressed, in part, by requiring NDE methods. Integrity testing might also be considered for drilled shafts constructed by the “dry” method if there is concern regarding possible collapse of the shaft excavation during concrete placement.

The recommended test methods are CSL and/or GGL, both of which are relatively inexpensive and provide useful information on concrete integrity over the full length of a drilled shaft. If GGL is used and identifies an anomaly, conduct CSL testing. If CSL is used, initially test the shaft perimeter and the main diagonals; test all tube pairs if initial testing identifies an anomaly. This approach also provides for the option of

conducting CT (tomography) testing in cases where anomalies are detected and further characterization is required.

Another approach taken by some agencies is to require all drilled shafts to be installed with access tubes, but CSL or GGL tests are performed only when a question arises about concrete integrity in response to some observation or incident during construction. Alternatively, a specified percentage of drilled shafts can be tested as part of routine quality assurance, with the option of additional tests if anomalies are detected or in response to construction observations. This approach provides the opportunity for tests (CSL, GGL, and CT) in any shaft and for any reason deemed appropriate by the engineer or contractor following construction. Whatever approach is adopted, it is important that NDE be integrated into an overall philosophy that includes best practices for construction and inspection.

Combining nondestructive test methods, for example CSL and GGL, can be an effective strategy for maximizing the benefits of downhole testing. CSL provides quality evaluation of concrete inside the reinforcing cage while GGL is more effective for evaluation of concrete in the zone providing coverage for the reinforcing cage. When anomalies are detected, these two methods are complementary and can be used to narrow the location of potential defects, thus providing information that can help to assess the potential impact of a defect on drilled shaft performance and for devising repair schemes. Liebich (2004) describes such a case at the Richmond-San Rafael Bridge seismic retrofit. Anomalies identified through GGL testing prompted further testing by CSL. The combined GGL and CSL readings confirmed the presence of defective concrete near the shaft tip and also that anomalies were limited to a zone around the perimeter of the shaft in seven (out of twelve) access tubes. A repair scheme involving high-pressure water jetting using the access tubes as conduits followed by pressure grouting was used successfully to mitigate the defects. Combined use of CSL and/or GGL with the thermal integrity (TI) method developed by Mullins (2008) and described in Section 20.2.4 may have merit, but requires further development.

For those interested in a more quantitative evaluation, Baker et al. (1993) describe a rating system using risk factors as a basis for establishing whether post-construction integrity testing is warranted and, if so, for selecting appropriate levels of testing. Note that, regardless of which approach is taken, high quality construction with proper quality control and inspection are essential elements of all drilled shaft projects.

### **20.5.2 Evaluation of Defects and Acceptance Criteria**

Figure 20-16 is a flow chart that illustrates an integrated approach to quality management for drilled shafts incorporating NDE. Key elements in the acceptance process are field observations during construction (inspection) and evaluations of concrete integrity through the use of cross-hole sonic logging (CSL), currently the most widely-used NDT method. This approach makes it absolutely critical to note and record any deviations from the plans or specifications on appropriate inspection forms (Chapter 19). Based on construction observations, a shaft could be rejected or accepted. After construction, CSL measurements provide a concrete condition rating based on Table 20-2. If CSL identifies an anomaly, look at the inspection records for an explanation. If the anomalous reading is minor, corresponding to velocity reductions up to around 20% and energy reductions of 9 dB or less, a significant defect is not indicated unless it corresponds to an observation during construction that would also support the possible defect. When CSL velocity reductions are in the range of “poor/defect” or worse (VR > 20% and energy reduction > 9 dB, see Table 20-2), with or without a correlation to an observed problem during construction, there is a need to characterize the nature of the anomaly further. This may include coring, use of downhole cameras, excavation to uncover the shaft to the depth of the anomaly, additional non-destructive testing, and, in some cases, load testing. Coring has limitations as noted previously and should be considered carefully in cases where the suspected defect is limited to the zone around the rebar cage.

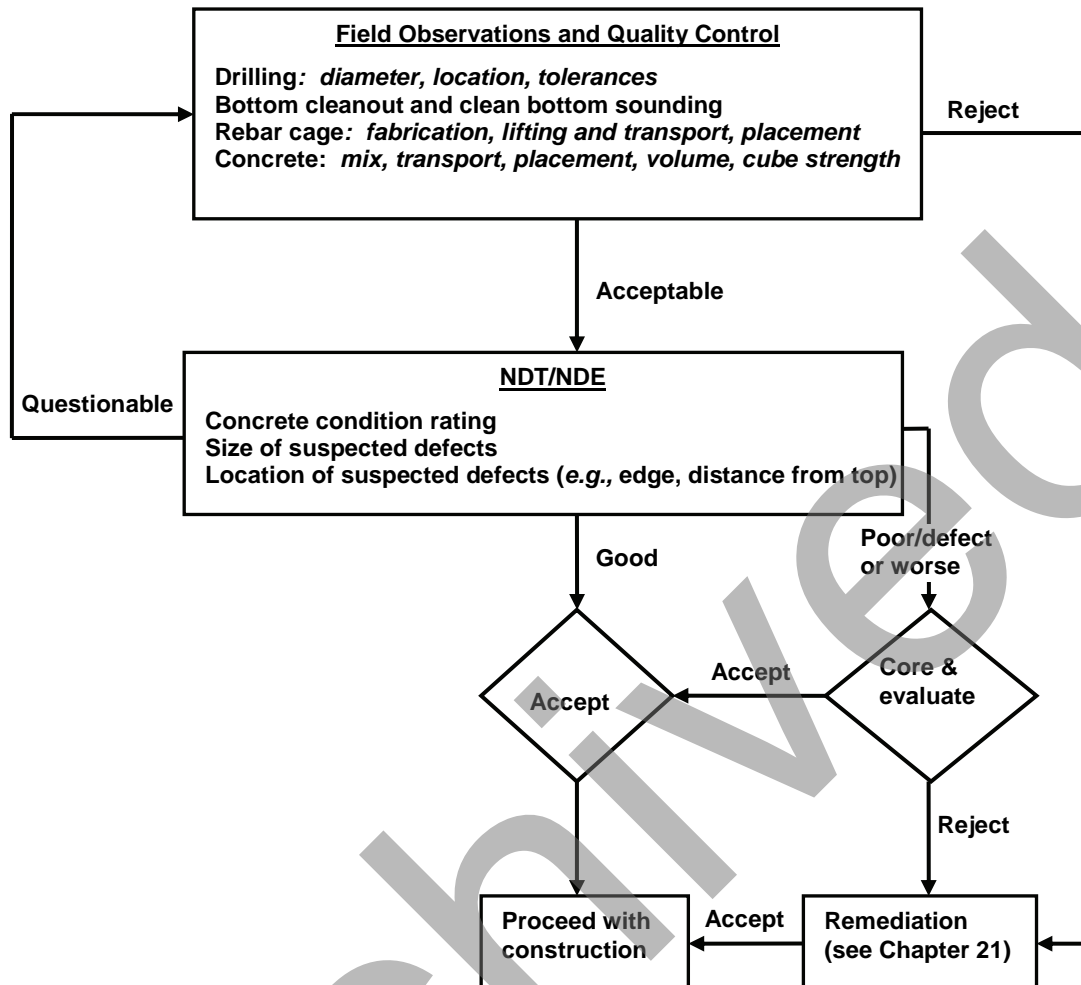


Figure 20-16 Drilled Shaft Acceptance Criteria Incorporating NDE (modified after C. Felice & Company 2002)

If a defect is found to exist, rational evaluation of the defect for its effect on drilled shaft performance should be based on analyses of shaft response under axial and lateral/moment loading. The major consideration should be the degree to which the defect reduces the ability of the shaft to satisfy LRFD strength and service limit state requirements. Methods for evaluating defects and their impact on shaft performance, as well as strategies and methods for remediation, are covered in Chapter 21, as indicated in Figure 20-16.

As a final note, it is important to understand that NDE testing is almost always subject to interpretation. False positives can sometimes occur, and defects can sometimes go undetected. The best method to minimize the uncertainty in NDE testing is to make sure that the tests are performed by qualified individuals who have had extensive training with the testing process and the equipment being used, and the test data interpreted by civil engineers who are familiar with the function and performance of drilled shafts. In interpreting the results of NDE tests, uncertainty can be further reduced if the interpreter has access to inspection records that document drilled shaft installation, especially unusual occurrences during installation and the exact point in the construction process at which such occurrences took place.

## 20.6 SUMMARY

Tests conducted on completed drilled shafts provide a means to verify that a quality foundation has been constructed. The most commonly used tests for this purpose are nondestructive tests (NDT) that are based on measuring some physical characteristic of the hardened concrete. Each test has advantages and limitations, and the results should always be considered in conjunction with construction observations.

This chapter presents an overview of the most commonly NDT methods for drilled shafts. Cross-hole sonic logging (CSL) is currently the most widely used method. Tomography, based on the same concept and involving the same equipment as CSL, provides enhanced evaluation of potential defects. Gamma-gamma testing is used extensively by several state agencies. These and other methods are described. Methods to further investigate the integrity of drilled shafts when there is reason to suspect a defect, including coring and load testing, are discussed. Guidance on the use of NDT and its role in the overall QA/QC program for drilled shafts is presented in Section 20.5.



## CHAPTER 21

### REMEDICATION OF DEFICIENT DRILLED SHAFTS

#### 21.1 INTRODUCTION

Even the most conscientious and careful drilled shaft installation program can be subject to incidents during construction. Bad weather, unexpected delays in concrete delivery, equipment breakdowns, or unanticipated ground conditions can produce imperfections or defects in the completed drilled shaft foundation. This chapter provides a description of some of the types of deficiencies which might be encountered and remediation methods which can be employed to correct them.

In most cases where a problem exists with a drilled shaft, the cause of the condition is known because of some incident that occurred during construction. For instance, a traffic accident or power outage at the plant might interrupt concrete delivery for some period of time, leading to a cold joint under slurry or difficulty with the tremie operations. It is important that responsible inspection and construction personnel describe and record the nature and observations of the incident immediately so as to help define the nature and possible extent of any imperfection which might result. Whenever practical, measures should be taken during installation of the drilled shaft to avoid forming a defect in the shaft. However, such corrective measures are not always possible or fully effective. Post-construction integrity testing methods, described in Chapter 20, are useful to help define the magnitude and extent of some types of imperfection.

It is important to consider that perfection in drilled shaft construction is an unattainable ideal. Some small imperfections are to be expected and a robust design should be tolerant of small and unavoidable flaws which may or may not be detected. An imperfection in the completed shaft is a deficiency requiring remediation when the shaft is insufficient or inadequate to meet the strength and serviceability requirements during the design life of the structure. In order to facilitate the consideration of these issues, the following definitions of terms are provided:

- Anomaly - deviation from the norm; an irregularity. This term is often used in reference to an anomalous pattern in the integrity test measurements. An anomaly may or may not represent a defect.
- Defect (noun) - a fault or flaw
- Deficient - insufficient or inadequate
- Mitigation - to make less severe
- Remediation - act or process of correcting a fault or deficiency
- Repair - restore to good or sound condition

In general, the terminology used in this chapter will refer to remediation or repair of a deficiency because the objective is to restore a foundation which is inadequate to one which meets the strength and serviceability requirements of the structure. Mitigation of a defect (making it less severe) might be a sufficient remediation strategy. Even if an anomaly is detected and determined to represent a defect in the shaft, no remediation might be required if the flaw is determined to be in a location or of extent that the foundation is not deficient.

In order to determine if remediation is required, the defect must be characterized using a process as outlined in the flow chart presented in Figure 20-19, and an evaluation of the foundation must be performed following the process outlined on Figure 21-1. Step 21 of the overall design process outlined in Chapter 11 is “Observe and Evaluate Construction of Production Shafts”. The flow chart of the remediation process is a subset of this step.

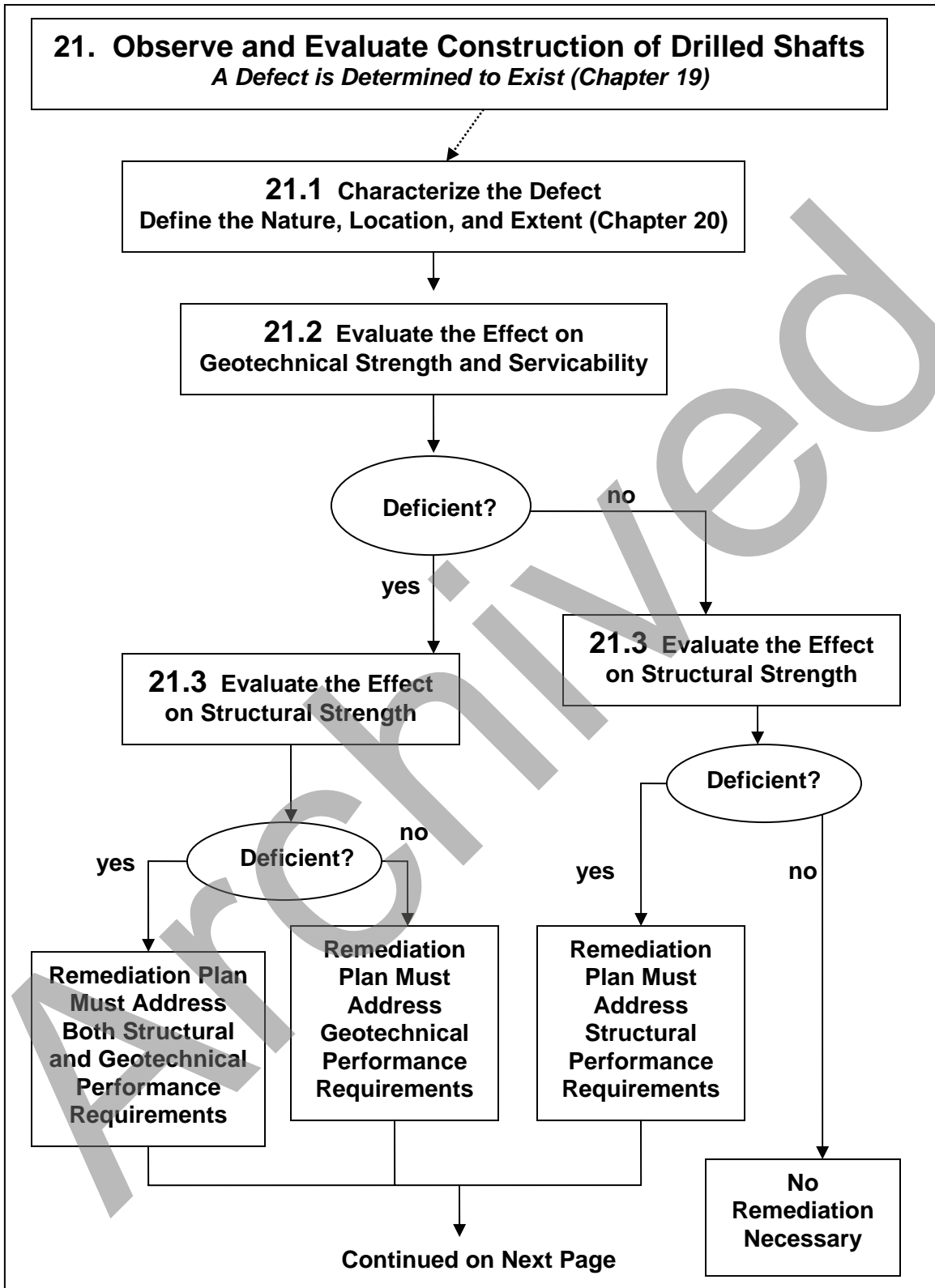


Figure 21-1 Flow Chart of the Evaluation and Remediation Process

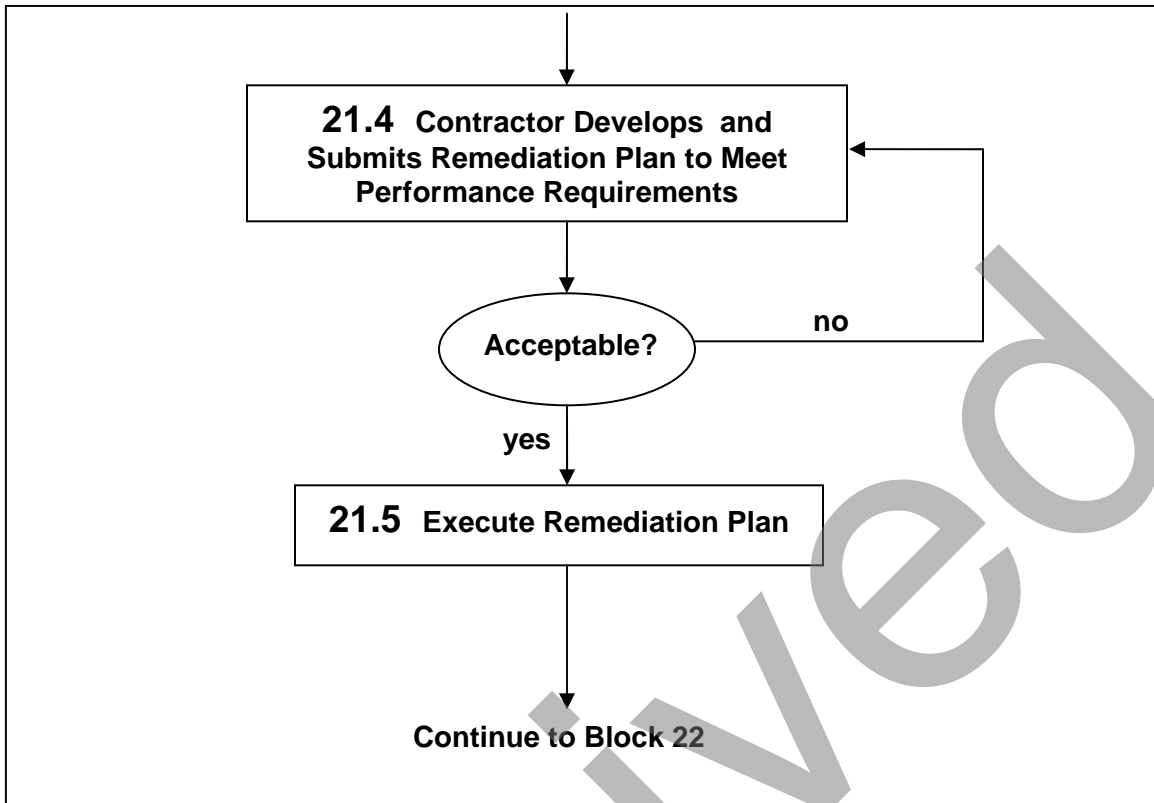


Figure 21-1 Flow Chart of the Evaluation and Remediation Process (Cont'd)

Note also that the development of a remediation plan due to constructed defects is normally the contractor's responsibility, subject to review and approval by the transportation agency. In many cases, the completion of the drilled shaft is a critical path item affecting the schedule, and in these circumstances it is imperative that the project team communicate effectively so that a satisfactory remediation plan can be developed and executed with minimal impact on the schedule and delivery of the project (with reliable foundations) to the public. In order to develop an acceptable remediation plan in Block 21.4, the contractor and the agency's engineers need to have agreement on the issues in the preceding blocks. Open "partnering" discussions to resolve issues can be very productive.

As an example of an effective strategy to resolve problems, the California Department of Transportation (Caltrans) worked jointly with the west coast chapter of ADSC: The International Assoc. of Foundation Drilling to develop standardized remediation plans for certain types of defects (Caltrans – ADSC, 2007). If both the contractor and the agency agree regarding the nature and extent of the defect, these standardized plans can be referenced to expedite the process of developing, accepting, and implementing a remediation plan. Caltrans is a large agency with many drilled shaft projects and a large number of contractors, and so the benefits of the effort to develop standardized remediation plans are significant.

Most agencies do not have such a large volume of drilled shaft construction activity, and in any event not all deficiencies are amenable to standardized remediation plans. Some deficiencies can occur with existing structures in-service due to loads or conditions that were not anticipated at the time the structure was built. The following sections describe some of the types of deficiencies which might be encountered and remediation strategies that might be employed to address them.

## 21.2 PROBLEMS PRIOR TO COMPLETION OF CONCRETE PLACEMENT

There can be incidents during construction that are most effectively addressed prior to completion of concrete placement. Some examples are described below.

- *Sidewall sloughing of the hole prior to completion.* The obvious remedy is that the stability of the hole must be restored with one of the techniques outlined in Chapter 4. If the geotechnical strength of the shaft may be adversely affected, it may be possible to adjust the diameter or length of the shaft prior to completion.
- *Loosening of the ground around or below the hole such that the geotechnical strength is reduced.* Adjustments in diameter or length prior to completion of the shaft may be a simple solution.
- *Inflow of water into a “dry hole” which might adversely affect geotechnical strength and/or concrete placement.* If the inflow cannot be controlled, then it is usually necessary to flood the excavation and to complete the shaft using wet hole techniques.
- *Problems with tremie concrete operations.* These can include failure of the joints in a segmental tremie, failure of the tremie to seal, withdrawal of the tremie from the concrete during placement, or a loss of workability of the concrete such that the tremie embedment cannot be maintained. In many (but not all) of these situations, the least expensive remediation strategy may be to stop the concrete placement, excavate the fluid concrete before it hardens, withdraw the reinforcement, and restart the process another day. Fluid or nearly fluid concrete can often be removed using a bucket or auger that will fit inside the reinforcing cage if there is so much concrete in the hole that the cage cannot be removed first. After extraction of the cage, the remainder of the concrete can be removed and the hole may need to be deepened slightly to restore a clean base or to compensate for any loosening of the ground which may occur.

In general, any decision to abandon concrete placement and re-excavate the hole is made by the contractor, who has the contractual responsibility to complete the work. The inspector's role is to observe operations and to report conditions which may be noncompliant with the specifications and/or installation plan to the project superintendent, construction manager, and other appropriate representatives in a timely manner.

It might also be noted that a problem with tremie concrete operations can be effectively addressed by suspending concrete placement with plans for a subsequent cold joint and completion of the concrete placement in the dry. This approach is generally only suitable if the concrete level has achieved an elevation that is above the groundwater or within a permanent casing.

- *Sidewall sloughing or water inflow during concrete placement.* If these problems occur during placement of concrete, the best strategy is likely to be to abandon the concrete placement operations and re-excavate the hole as described above.

It is appropriate to discuss and evaluate potential construction and concrete placement problems prior to the start of construction and to develop contingency plans for dealing with them. Contingency plans to address potential problems are appropriate requirements for submittal as a part of the Drilled Shaft Installation Plan.

## 21.3 TYPES OF DEFICIENCIES IN COMPLETED SHAFTS

The remainder of this chapter deals with deficiencies and remediation in completed drilled shafts. The defects described below may require remediation if the magnitude and location is sufficient to affect the strength or servicability of the drilled shaft.

### **21.3.1 Geotechnical Strength or Servicability**

Even though the shaft may be structurally sound, there can be deficiencies with respect to geotechnical strength or serviceability. These include incorrect dimensions or location, and construction problems which lead to inadequate axial or lateral resistance. Some deficiencies may be identified with existing structures due to a change in ground conditions or loadings for which the foundations were not originally designed.

In many cases the design can be made more robust and accommodating of disturbance from construction activities by a conservative design with respect to axial or lateral resistance of shallow soils. A sensitivity analysis during design may indicate that a cost effective design can be produced with relatively little reliance on shallow strata, thus avoiding or minimizing potential issues relating to lateral or axial side resistance.

#### **21.3.1.1 Incorrect Dimension or Location**

Incorrect dimension or length may result from simple errors or inattention to the geotechnical conditions actually encountered. For instance, a shaft has an anticipated tip elevation of +75 ft and is also required to penetrate 30 ft into a shale formation that is anticipated to be encountered below elevation +105 ft. If the top of rock is encountered at an elevation which is deeper than anticipated, then the shaft must be lengthened accordingly to provide the 30-ft socket and satisfy the geotechnical strength requirements. Failure to deepen the shaft in accordance with the actual ground conditions may result in a reduced axial resistance.

A shaft which is constructed at a location out of position as a result of a survey error may be subject to unanticipated eccentricity.

#### **21.3.1.2 Inadequate Base Resistance**

Inadequate base resistance can result from several factors such as:

- Weak soil at the base because the shaft was founded in the wrong stratum.
- Weak soil at the base because of inadequate cleaning, leaving loose debris between the concrete and the bearing material.
- Loosening of the bearing stratum due to instability at the bottom of the excavation prior to concrete placement.
- Weak concrete or washed aggregate at the base because the concrete was dropped through water within the shaft excavation.
- Settlement or loss of the bearing stratum away from an existing drilled shaft foundation. Construction activities which could affect base resistance include tunneling below the foundation, vibrations from nearby construction operations such as pile driving below the base of the drilled shaft, or the construction of new, deeper drilled shafts in very close proximity. In karst terrain or areas of underground mines, a previously undetected void might be identified beneath an existing drilled shaft.

### **21.3.1.3 Inadequate Axial Side Resistance**

Inadequate axial side resistance can result from several factors such as:

- Failure to recover temporary casing within a zone contributing to side resistance.
- Softening of the soil or rock at the sidewall due to excessive exposure or seepage. Some types of shales and claystones are susceptible to rapid weathering in an open excavation.
- Excessive buildup of contamination at the sidewall due to excessive exposure to bentonite slurry.
- Loosening of the soil around the shaft due to instability of the excavation.
- Scour or other excavation of soil around an existing drilled shaft that was not designed for this condition.

### **21.3.1.4 Inadequate Lateral Resistance Around Shaft**

Inadequate lateral resistance around the drilled shaft can result from failure to recover temporary casing which was installed in an oversized hole, or due to collapse of the excavation and disturbance of surrounding soil during construction. Other construction operations such as installation and extraction of temporary piles can also affect soil contributing to lateral resistance.

## **21.3.2 Structural Strength**

Even if the shaft is constructed adequately with respect to geotechnical strength, deficiencies relating to inadequate structural strength can occur. Structural demands on drilled shafts loaded primarily in axial compression are usually low, and so the greatest concerns arise when there are structural defects within the length of the shaft subject to significant bending moments. Some types of structural defects which may require evaluation and remediation are discussed below.

### **21.3.2.1 Incorrect Dimensions or Location**

Errors in which the shaft is constructed in the incorrect location or with incorrect dimensions or reinforcing may pose an issue requiring evaluation of structural performance.

### **21.3.2.2 Structural Defects in Concrete**

Structural defects in concrete are among the most commonly encountered problems with drilled shaft construction. One likely reason that defects in concrete are so often noticed is because the integrity testing methods described in Chapter 20 have become so effective that even small flaws not previously noticed are now identified. Another is the fact that drilled shaft foundations are increasingly used to large diameters and great embedded length with very congested reinforcing cages, often with embedded column reinforcement. As a result of the industry's success in completing such difficult projects, the constructability demands on the concrete placement operations are more severe than was ever previously attempted. Designers should consider the issues and concerns outlined in Chapters 4 and 9 so that reinforcing cages and concrete are appropriately designed for constructability so that the risks of structural defects are minimized.

Some of the problems resulting in structural defects in concrete include the following:

- Soil inclusions due to sloughing of the sidewall during concrete placement.
- Soil inclusions due to settlement of suspended solids in the slurry during concrete placement. Slurry materials and testing are described in Chapter 7.
- Entrapped laitance due to excessive bleeding, segregation, and/or loss of workability in the concrete. Concrete properties and the importance of workability are described in Chapter 9.
- Cold joints or trapped laitance or debris due to an interruption in the tremie placement of concrete under water or slurry.
- A breach of the tremie seal into the fresh concrete during placement due to improper withdrawal of the tremie or a sudden drop in the concrete level such as might be associated with flow into voids around the excavation as casing is withdrawn.
- Leaching of the concrete due to inflow of water through joints or voids in the subsurface formation. Artesian groundwater conditions require that a positive pressure head be maintained in the shaft excavation at all times.
- Necking or displacement of concrete due to arching within a temporary casing as it is withdrawn.
- Infiltration of drilling fluid into joints of the tremie pipe.
- Inadvertent use of incorrect concrete mix of lower strength.

### **21.3.2.3 Inadequate or Exposed Reinforcement**

Some of the structural defects in the concrete described above can compromise the cover of concrete around the reinforcement. Such defects can occur from trapped debris or laitance or from loss of workability during the placement operation that leads to blockage and failure of the concrete to flow through the cage. Structural reinforcement which is or may be exposed to corrosion within the life of the structure represents a deficiency which may require remediation.

### **21.3.2.4 Structurally Damaged Shaft Due to Overload after Construction**

A drilled shaft can be damaged and in need of remediation if it is overloaded to the point of structural yield. Existing structures may be affected by vessel or truck impact loads in excess of the structural strength of the shaft, or by seismic overstress. The authors are aware of cases in which a drilled shaft has been impacted by a contractor work barge or runaway equipment during construction, resulting in structural damage to a column/shaft that required remediation. In some cases of this type, an accurate and reliable assessment of the current condition of the foundation may present a significant challenge; if the strength of the damaged foundation cannot be assured, then a conservative assessment must be made for purposes of remediation.

## **21.4 EVALUATION**

A full restoration of the shaft to its design structural and/or geotechnical strength may be accomplished in some cases without the need for anything more than a cursory engineering evaluation and modest repair program. In general, this approach is used where structural defects (as characterized in Block 21.1 of the flow chart) may be close to the top of the shaft and easy to repair by simple hand methods of chipping and reforming the shaft. For instance, Caltrans standardized mitigation plans allow that the contractor may choose to implement one of the standardized mitigation plans to restore the full strength of the shaft without further

need for evaluation.

For defects which are less easy to repair, an engineering evaluation is the first step toward determining the need for remediation and subsequent development of a remediation plan to correct any deficiency.

The evaluation of geotechnical strength involves an assessment of the nature and extent of the problem and the potential impact on the geotechnical performance. In cases where only the geotechnical strength is in question, it may be possible to consider the following actions:

- Evaluate the actual demands on the specific shaft subject to review. For simplicity during design, sometimes all of the shafts in a group or within a section of the project are designed for the largest load demand which is anticipated for any shaft, and the specific shaft in question may be subject to an actual load demand that is somewhat less.
- Evaluate the specific geotechnical conditions at the location of the shaft. This evaluation may involve additional geotechnical exploration if a boring at the specific shaft location is not available. For example, it may be that a more detailed evaluation of the soil or rock conditions at the specific shaft in question could be more favorable than the general simplified conditions used to establish tip elevations. If so, it might be possible to justify an increase in the estimated axial resistance in some portion of the shaft in order to compensate for a deficiency elsewhere (such as a stuck temporary casing, for instance).
- Perform a proof test of the shaft in question. In some cases an evaluation of geotechnical strength could include a proof test using a rapid load test, dynamic load test, or even a static load. Even if the geotechnical strength is determined to be less than the nominal strength used for design, the fact that a proof test was performed on this specific shaft should allow a higher resistance factor to be used for this specific shaft. The specific resistance factor to apply to an individual drilled shaft subjected to a proof test is not defined by AASHTO LRFD Specifications at present and would require the judgment of the design engineers.

The evaluation of structural strength involves an assessment of the nature and extent of the structural defect and the potential impact on structural performance. Structural considerations are generally dominated by flexural strength demands. A p-y computer model of the shaft using the methods outlined in Chapter 12 with the actual demands for the specific shaft should be used to determine the flexural demand at the location of the structural defect. Often, the bending moment is small in the deeper portions of the shaft.

If the defect is within a portion of the shaft that includes permanent casing, the actual as-built structural strength of the composite section may be considered in this portion of the shaft. If the defect is assessed to consist of low strength concrete, a steel shell section filled with lower strength reinforced concrete might still provide sufficient structural strength in some cases without remediation measures.

An evaluation of the structural strength of a drilled shaft cross section with low strength concrete or soil inclusion over a portion of the section should be based on a conservative assessment of the character and extent of the defect from integrity testing, coring, and/or other techniques. Exposed reinforcement may be discounted because of possible future corrosion. The structural evaluation of the strength of an imperfect cross section requires engineering judgment and analyses that is beyond the scope of routine design work. A discussion of the flexural behavior of drilled shafts with minor flaws is provided by Sarhan, et al (2002) and Sarhan and O'Neill (2002).

## **21.5 REMEDIATION METHODS**

After evaluation of the defect and determination of a deficiency in geotechnical or structural strength, a plan for remediation is required. The plan should provide a means to restore the required performance



characteristics of the drilled shaft in a way that is constructible and reliable, and that includes a program of monitoring or verification that will provide assurance that the remediation is successful. The sections which follow outline some remediation measures that have been used successfully. The list is not exhaustive, but is intended to provide a useful resource.

### **21.5.1 Ground Improvement**

Ground improvement techniques can be used to restore geotechnical strength for situations where disturbance of existing materials may have occurred during construction or due to environmental factors. Ground improvement techniques might include:

- Penetration grouting to fill voids around a shaft such as might occur with a casing left in place in an oversized hole.
- Compaction grouting to restore density of granular soils that may have been loosened below or around a drilled shaft.
- Vibro-compacted stone columns to improve density and reduce liquefaction susceptibility around an existing drilled shaft.
- Grouting might also be employed to treat loose materials below the base of a shaft by drilling through the shaft to access the bearing soils below the base. This type of grouting operation is more of a replacement technique than a ground improvement, and is described subsequently in Section 21.5.5.

In some cases, ground improvement of shallow soils to improve stiffness and strength around foundations for lateral loads may consist of excavation of loose or disturbed soils and replacement with flowable fill. Flowable fill is a cement-stabilized sand mixture that can be placed like fluid concrete without the need for compaction. Other applicable techniques might include deep soil mixing, jet grouting, lime stabilization, and vibratory compacted stone columns, among others. At the time of this writing, research project NCHRP 24-30 (Rollins et al, 2010) is ongoing and expected to develop recommendations for analysis and design of ground improvement techniques to improve the lateral performance of deep foundations.

### **21.5.2 Supplemental Foundations and/or Structural Bridging**

In some cases where the strength or stiffness of a drilled shaft is less than required, the most effective remediation strategy might be to add additional deep foundation elements. These might be designed to supplement or even completely replace the existing shaft. Additional shafts or micropiles are generally the most suitable type of deep foundation support element for use near an existing shaft, and these are described in more detail below.

It should be noted that the design of a foundation incorporating additional deep foundation elements into a common cap with the existing drilled shaft must address the issue of strain compatibility; the shear distribution in the cap will be affected by the relative stiffness of the various elements supporting the cap. For instance, if additional deep foundations extend into rock and are very stiff in comparison to an existing shaft, the cap may be subject to high shear forces as illustrated in Figure 21-2. Additional deep foundations composed of relatively flexible micropiles may be relatively less stiff in comparison to a large diameter existing drilled shaft foundation. Pre-loading of the new foundation elements can sometimes be used to address strain compatibility.

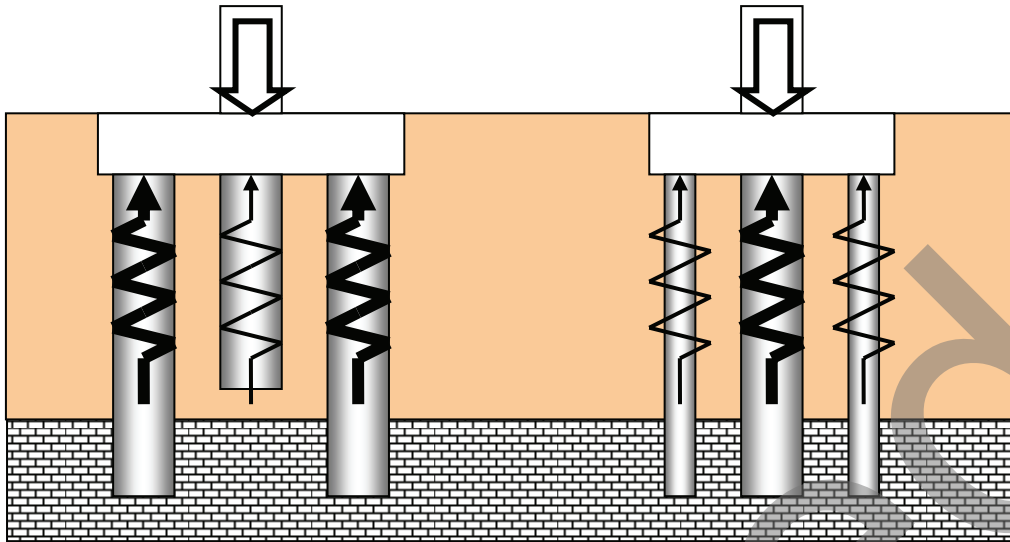


Figure 21-2 Differing Relative Stiffness of Deep Foundation Elements Can Affect Shear Forces in Cap

### 21.5.2.1 Additional Shafts

Underpinning with “straddle shafts”, sometimes called “sister shafts”, is a method of supplementing or replacing a defective drilled shaft. The existing shaft may be chipped away and eliminated from inclusion in the new foundation, but this approach is usually not necessary unless the existing shaft is so badly damaged that it is considered a liability and of no benefit.

An example of the use of straddle shafts is illustrated in Figure 21-3, where existing pile foundations for a bridge in Arizona were completely undermined by scour. These foundations represented a complete replacement of the existing foundation.



Figure 21-3 Use of Straddle Shafts to Replace an Existing Foundation (photo by B. Berkovitz)

The sketch and photo in Figure 21-4 illustrates another example of the use of “sister shafts” to provide supplemental support for an existing shaft which was structurally sound but deficient in axial resistance. An additional 4-ft diameter shaft was constructed on each side of the existing column, which itself was supported on a single 6-ft diameter shaft. In order to keep the size of the cap as small as possible, the “sister shafts” were constructed as closely as possible and the composite foundation was analyzed as an elliptically shaped barrette foundation with end bearing contributions only from the two new, deeper shafts. The column was roughened and tied to the new post-tensioned cap using dowels.

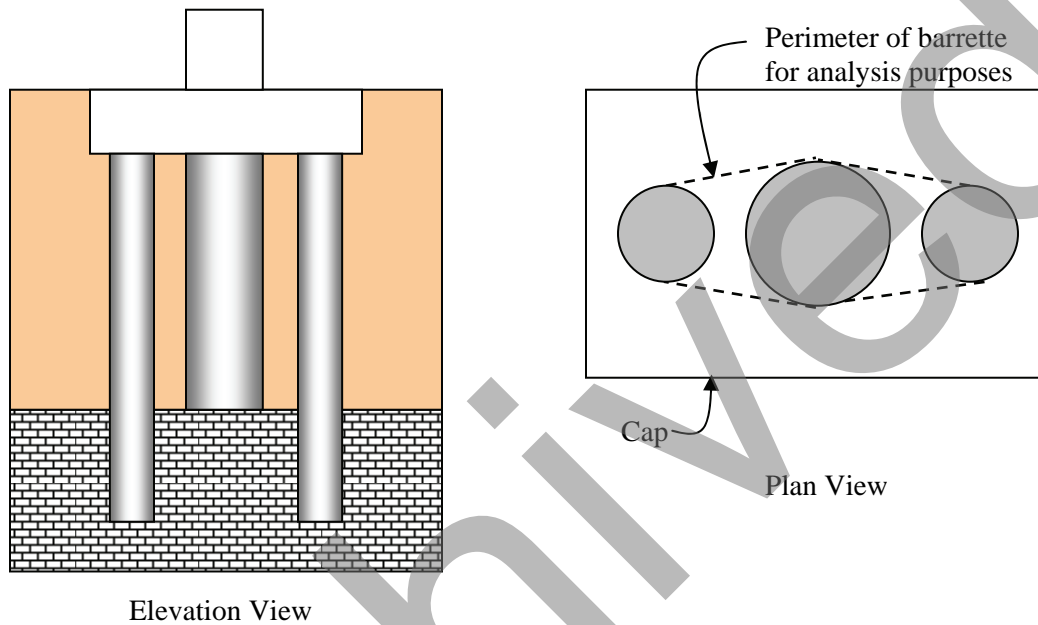


Figure 21-4 Use of Sister Shafts to Supplement an Existing Foundation (McGillivray & Brown, 2007)

### 21.5.2.2 Micropiles

Micropiles may be used as additional deep foundation elements to supplement or replace an existing shaft. Micropiles are typically 12 inches or smaller in diameter, and are constructed as a steel member (pipe or high strength bar) which is grouted into the bearing material. The design and construction of micropiles is described in FHWA-SA-97-070 by Armour, et al. (2000). One advantage of micropiles for underpinning work is the small size of the equipment used to install these foundations, which often allows their use in locations with restricted access or severe height limitations. Sometimes micropiles can even be installed by drilling through an existing drilled shaft in order to anchor the shaft into an underlying formation as illustrated in Figure 21-5. For this application, the top of the shaft must be accessible. In some cases it is even possible to install these by drilling through existing tubes used for integrity testing. High strength bars or even conventional reinforcing bars, depending upon the application and loads, may be used to form the micropile. The micropile steel must have sufficient development length to bond to the existing shaft. When installed through the existing drilled shaft, micropiles can provide additional structural strength to the shaft.

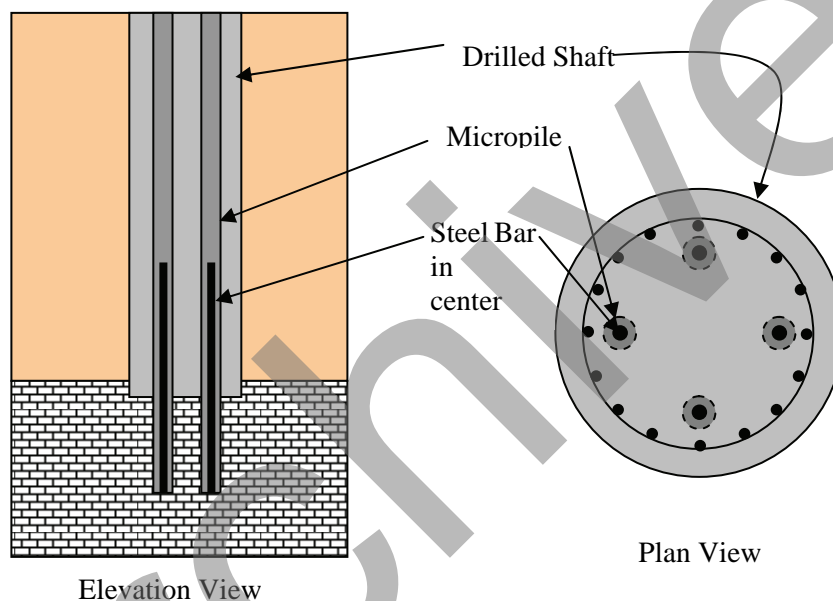


Figure 21-5 Use of Micropiles Drilled Through Existing Drilled Shaft

Where micropiles are used around an existing shaft, as illustrated in Figure 21-6, it is frequently possible to construct the piles very close to the existing shaft and thereby minimize the size of the cap. These micropiles are constructed using 10.75-inch O.D. steel pipe casing installed to rock, with a 75 ksi grouted bar installed within the casing to form a socket into bedrock. A cap was subsequently formed around the column and micropiles similar to the one shown in Figure 21-4.

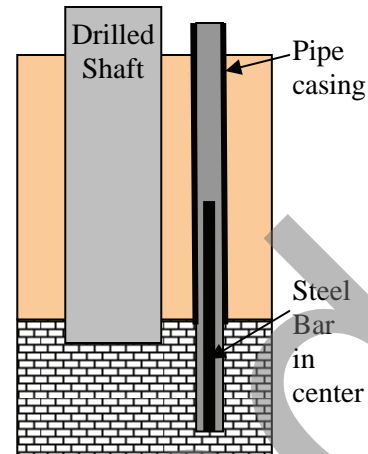


Figure 21-6 Use of Micropiles to Supplement an Existing Foundation (McGillivray and Brown, 2007)

### 21.5.3 Excavation and Replacement

Excavation and replacement is a feasible repair method for structural defects in shafts that are relatively shallow and therefore accessible from the surface. Poor quality concrete in the top of a large diameter shaft may be removed by hand with impact tools, and it may be possible to use a drilled shaft rig to excavate concrete within the reinforcing cage with rotary tools. If the upper portion of the soil around shaft can be excavated and a dry working environment secured, hand methods may be used to chip away defective concrete and the upper portion of the shaft re-cast within a form. Figure 21-7 provides two photographs of this type of repair work.



Figure 21-7 Excavation and Replacement of Defective Concrete Using (a) Drilling Tool within the Cage and (b) Hand Methods (photos courtesy Caltrans)

### 21.5.4 Structural Enhancement

Structural enhancement can be performed to increase the structural strength of a defective shaft without complete removal of the defect. For instance, if the center of the shaft is drilled out as illustrated in Figure 21-7a, it may be possible to install a structural steel or pipe section cast into the central portion of the shaft with high strength concrete. This additional member may be designed to restore the structural strength of the shaft to meet the project requirements as illustrated in Figure 21-8. It may also be possible to extend a central drilled section into the bearing formation below the shaft in order to increase the geotechnical strength of the shaft.

Structural enhancement can also be accomplished by drilling holes in the shaft and grouting in additional rebar, high strength bars or strands as was illustrated with the micropile repair in Figure 21-5.

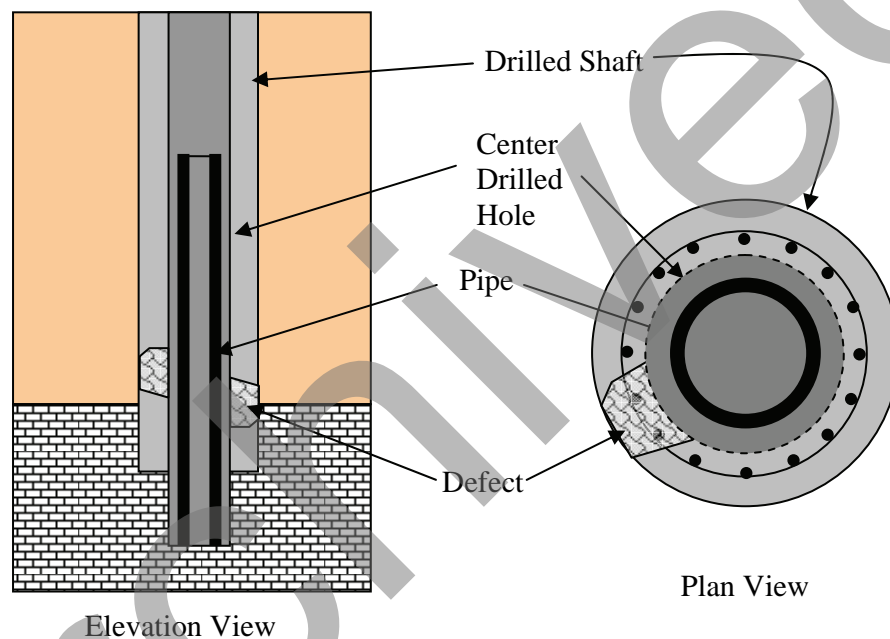


Figure 21-8 Use of a Steel Section Cast into a Drilled Shaft to Form Structural Bridge

### 21.5.5 Grouting

Grouting may provide a means of directly treating the defective area to improve or restore the structural and/or geotechnical strength. Grouting may be performed at the base of the shaft to address a problem of loose material below the shaft base, within the shaft to address structural defects, or around the shaft to provide bond to the soil and/or cover for corrosion protection.

#### 21.5.5.1 Grouting at the Base of the Shaft

A defect at the shaft base, caused by trapped material or washed aggregate, can sometimes be treated by grouting the base of the drilled shaft. The grouting of the base of a drilled shaft will usually involve the following steps:

- At least two holes are drilled through the full length of the shaft so that fluid can be circulated to and through the soft zone at the base of the drilled shaft. These conduits are normally available as access tubes if access tubes have been installed for integrity testing or as drill or core holes that were placed during an investigation of the quality of the base.
- Wash or flush the defective zone by pumping water or an air - water mixture down one tube and returning it with suspended debris through the other(s).
- After a clear return is obtained and debris has been removed to the extent possible, inject the grout into one hole until grout returns through the other(s). After grout has flushed all of the wash water through all of the tubes, seal all of the return tubes and apply pressure grouting.
- Monitor the shaft for upward movement, and log the volume and pressure of grout taken as a function of time as would be performed with planned base grouting for enhancement as described in previous chapters.

With at least two holes through the drilled shaft and into the weak base material, the weak material at the base can be washed away by forcing fluid down one of the holes and having it return through the other. An air-water mixture under high pressure can be an effective technique except when the drilled shaft is founded in cohesionless material. In that case, no air and low pressures must be used so as not to undermine nearby drilled shafts. The solids in the returning fluid should be monitored during the process as a means of evaluating the efficiency of the washing operation. As the cleaning of the base of the drilled shaft progresses, it may be possible or desirable to inspect using a television camera or concreteoscope if the base is within a rock formation.

#### **21.5.5.2 Grouting Within the Shaft**

Grouting may be used to repair zones of defective concrete within the shaft. In this application, the most challenging part of the operation may be the removal of low strength material. Hydroblasting, or erosion of weak concrete using high pressure water jets, has been used with success. Access holes are used to introduce water jets and observe communication between holes and return up through these holes. Some photos of downhole hydroblasting equipment are provided in Figure 21-9, and a downhole photograph of the treated area is shown in Figure 21-10. These high pressure water jets are capable of nozzle pressures in excess of 20,000 psi and can cut concrete at close range (within a foot or so) if the jet can be directed and is not shadowed by steel reinforcing. It is not normally feasible to remove large quantities of concrete in this manner.

After completion of the hydrodemolition and water jetting to flush the cuttings and debris from the hole, the access hole should typically be pumped dry or vacuumed to provide the most effective means for grout to fill voids effectively. The photo in Figure 21-11 shows a core taken through the grouted zone within a repaired shaft, with the grout stringers clearly visible within the concrete matrix.

This technique can be used to remediate and improve concrete which has inclusions of soil or low strength concrete, and often is sufficient to restore the structural strength to meet the project requirements. Grouting cannot be expected to restore the shaft to a perfect condition. Post-treatment cores or crosshole sonic logs should show improvement, but will not be free of anomalies.

Grouting within the shaft as described above may not be effective if the defects to be treated include zones on the outside of the reinforcing cage in granular soils below the groundwater. In such a case, attempts to hydroblast outside the shaft would erode unstable soils which might be expected to cave. Jet grouting around the perimeter of the shaft is a technique which might be considered, as described in the following section.

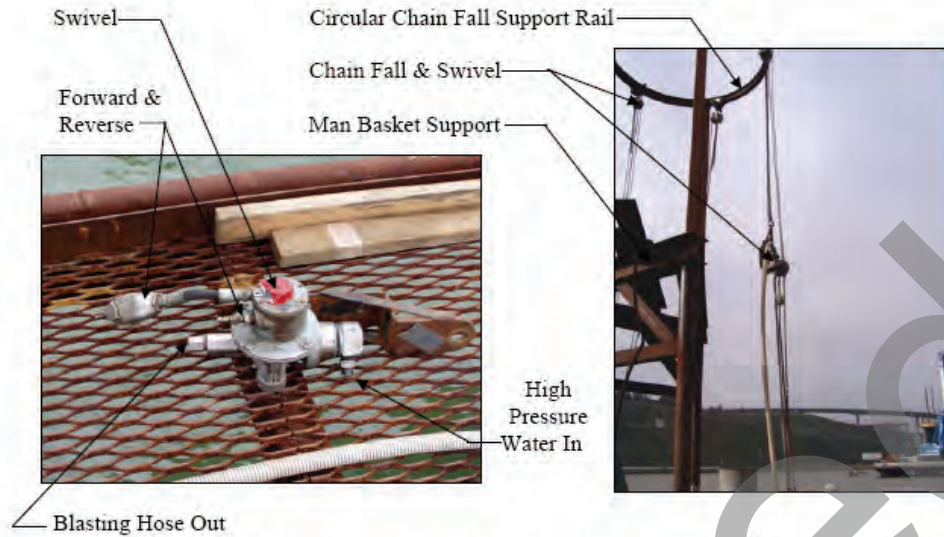


Figure 21-9 Hydrodemolition Tools (photo courtesy Ben C. Gerwick, Inc.)

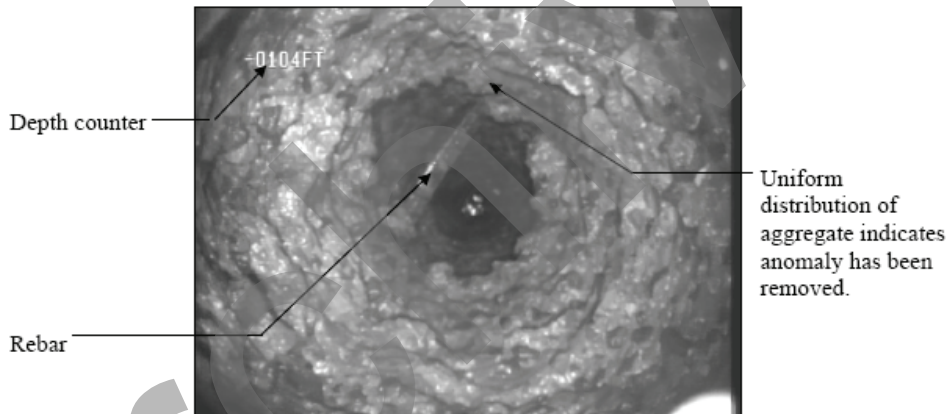


Figure 21-10 Downhole Camera View of Access Hole after Hydrodemolition (photo courtesy Ben C. Gerwick, Inc.)

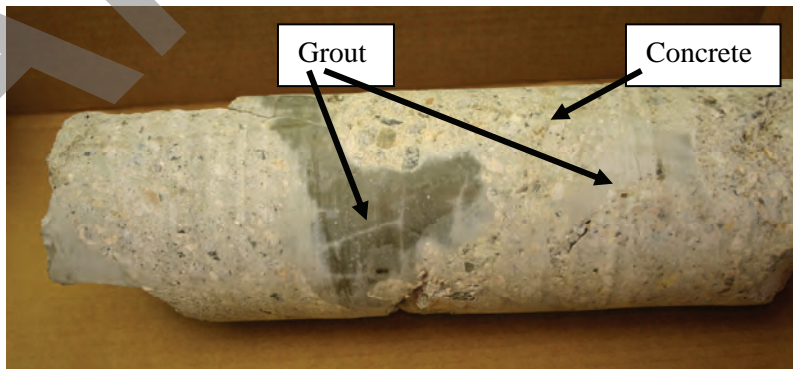


Figure 21-11 Concrete Core Through Grouted Concrete Repair (photo Ryan McTigue, Raito, Inc.)



### 21.5.5.3 Grouting Around the Perimeter of the Shaft

If the shaft is structurally sufficient except for concerns regarding the concrete cover on the reinforcement, or if a void exists between the outside of the shaft and the soil, then grouting around the perimeter may be considered. In the simple case of a stuck casing with a void left around the casing, tremie grout into the void using small diameter tubes may be sufficient to fill the gap and restore the lateral soil resistance. If there are voids or defects in the concrete around the perimeter of the shaft below the groundwater, jet grouting may be considered as a means to erode soil or weak material and provide a cementitious encasement of the shaft.

Jet grouting has a history of use for ground improvement, often for stabilization of weak soils around excavations or walls. A column of grout is formed by a drill equipped with sideward directed nozzles which cut the soil and flush most of it back to the surface, replacing it with grout. The jets can include combination of grout, water, and air to enhance the cutting ability. Photos of jet grouting equipment and some excavated jet-grout columns are provided in Figure 21-12 (Axtell and Stark, 2008).



Figure 21-12 Jet Grouting Photos and Illustration

The nozzle pressure is much lower than that used for hydrodemolition and typically around 1000 psi. This pressure will cut soil or relatively weakly cemented inclusions in the shaft but will not erode good concrete. Therefore, the technique is most useful for encapsulating a drilled shaft as illustrated in Figure 21-13. Note that the jet grout columns can be started and stopped at predetermined elevations corresponding to the zone needing treatment, and it is not necessary that the column extend the full height of the shaft. It is also possible that jet grouting could be used to treat an area around a shaft in order to stabilize the shaft prior to internal hydrodemolition and grouting.

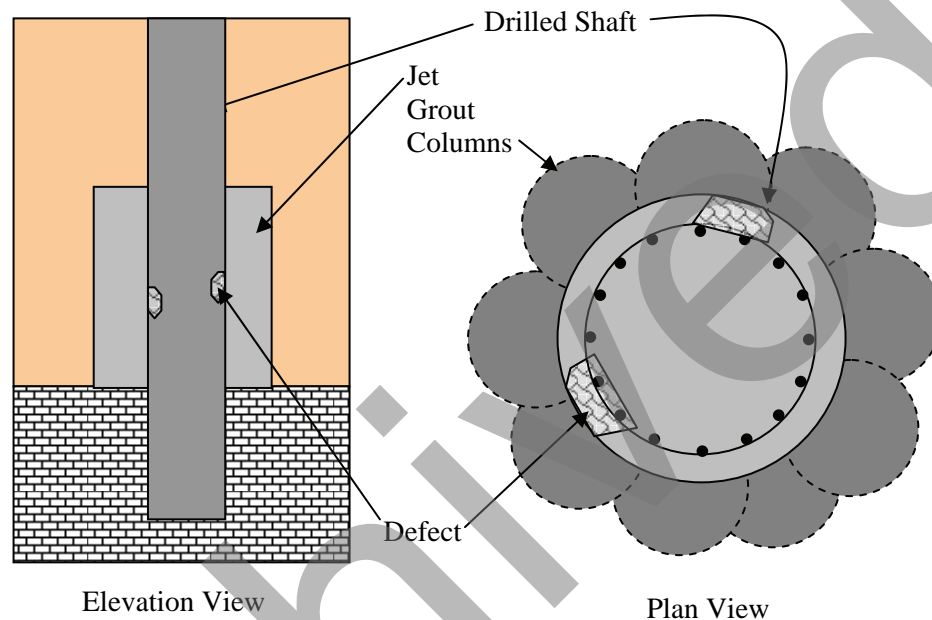


Figure 21-13 Jet Grouting Application for Drilled Shaft Repair

## 21.6 SUMMARY

This chapter provided an overview of some of the types of deficiencies which can be encountered in drilled shaft construction, and outlined some strategies which might be effective in restoring the shaft to meet the performance requirements. If a defect is detected, it is important to understand the cause of the problem so that it can be avoided on future shafts and also so that the extent of the defect can be defined for evaluation purposes. Not all defects represent deficiencies that must be repaired. When repairs are required, there are a number of effective measures that can be employed as outlined in this chapter. The most effective repair technique depends upon the location and type of deficiency. A good quality control plan should be agreed upon and implemented before starting the remediation process. This can include effective use of core holes for the dual purpose of investigation and repair, pre-repair and post repair CSL or 3DT thermography, and location of post repair case holes and tests if needed.

## CHAPTER 22

### COST ESTIMATION

#### 22.1 GENERAL

Estimating the cost of drilled shaft foundations is Step 15 in the overall design and construction process outlined in Chapter 11 (see Figure 11-1). During the planning phase of a project, preliminary estimates made by the design engineer are used to compare the costs of drilled shafts with other technically feasible foundation systems. These estimates may be one of the deciding factors in selecting the foundation type. During final design, the engineer makes a cost estimate that will be used to estimate total project costs prior to bid. The *actual* cost of drilled shafts is established in the open marketplace through the process of competitive bidding. The best way to obtain the lowest overall cost of a foundation for a highway construction project is to design competing foundation systems and to request bids on each of the systems. The extra engineering time is generally more than offset by the savings in cost that will result. For large projects (\$40 million or larger) the FHWA often requires that alternate designs be made and, normally, the design alternate with the lowest bid price is accepted.

This chapter briefly addresses the factors that impact costs of drilled shaft foundations and gives some general guidance on estimating costs.

#### 22.2 FACTORS INFLUENCING COST

The cost of constructing drilled shafts will vary widely with geographic location and with the passage of time. The cost will also be affected by the quality and detail of the subsurface data available to the bidders and by the assumptions that the contractor makes regarding the construction method expected to be used. These and other factors are listed and discussed briefly in the following paragraphs:

- Subsurface and Site Conditions: This factor probably has the largest influence on the cost of construction. The difficulty of drilling will vary widely; for example, rock will be relatively soft in some locations and extremely hard at other places. Other site conditions will also have a big influence on cost, with the most important factors being: trafficability, nearby structures, traffic control, underground utilities, overhead lines, overhead bridge decks, trees, contours, and cut-off elevation of drilled shafts in relation to the ground surface. Difficult site access and difficult time restrictions such as night work and lane closures can have a large impact on cost. For example, costs of providing and operating low-headroom drill rigs are approximately three times the cost of rigs that operate in the open. Also, when low-headroom drilling is necessary, permanent casing is the norm because there is insufficient room for casing extraction.
- Geometry of Drilled Shaft: The cost per unit volume or length of drilling at a shallow depth will be less than that for a greater depth. In drilling soil, the unit cost of drilling per unit volume is less as the diameter of the hole increases until the hole becomes so large (typically larger than about 8-ft diameter) that readily available equipment cannot accomplish the drilling. In drilling rock, it is difficult to state the influence of diameter; however, holes with a larger diameter become increasingly more difficult to drill in hard rock.

- Number of drilled shafts on the project: Typically, projects with a larger number of drilled shafts will result in a lower unit cost since mobilization, planning, management, and testing costs are spread over a larger number of foundations.
- Specifications, including inspection procedures: Some specifications are written in such a manner as to make a large impact on cost; for example, permanent casing can be required in some instances where the job could be constructed as well or better without the use of the permanent casing. There are occasions when it is known that a "tough" (interpreted as "unreasonable") inspector will be on the job. Some contractors raise their prices to adjust to such a situation. Whether excavation is considered to be classified or unclassified can impact bid costs. Requirements for nondestructive testing and evaluation (NDT/NDE) will also increase bid costs, in particular if the contract calls for the contractor to be penalized for negative test results. NDT/NDE is covered in Chapter 20. As a general rule, specifications that dictate the use of a particular construction method (a "method spec") will drive up pricing.
- Obstructions: The issue of obstructions and how they are addressed can result in significant cost differences in large diameter drilling. Many owners pay the contractor for removal of obstructions, although some pay only for man-made obstructions. The no-obstruction projects receive large contingencies in their bids. The man-made-obstruction-only projects lead to medium sized contingencies, and the projects that pay all obstructions by cost reimbursement result in low contingencies.
- Expected weather conditions: Weather is an important factor regarding cost of construction. For example, harsh winter weather conditions can be expected to influence worker productivity. Contractors who work in these conditions are very much aware of the impact and will incorporate this into their bid prices.
- Work time restriction:s Projects, particularly in urban areas, may have restrictions as to when work may be performed. Such restrictions decrease productivity and increase contractors' costs.
- Location of work as related to travel and living costs of crew: The cost of some projects is significantly greater than others because of location. Travel time and living costs can vary widely from place to place. Examples of locations with high travel and living costs are Alaska and Hawaii.
- Time allowed for the construction and penalty clauses: Some jobs are laid out on a very tight construction schedule and with a significant penalty if the work is not done on time. Drilled shafts can usually be constructed relatively rapidly, but the time for construction must be reasonable in order to control the cost.
- Work rules: The number of workers that are required for constructing a drilled shaft can vary from place to place. For example, in only some places is an oiler required. Also, restrictions on what a particular worker can do will vary. In some locations a certified welder is required for any welding that is needed, but in other locations the general workers on the job can perform tack welding. Costs will differ depending upon whether labor is union or non-union.
- Governmental regulations: The influence of governmental regulations on the cost of construction has been increasing in recent years as the sensitivity to environmental effects has increased. Restrictions concerning the pollution of the air and water have become more severe, and more attention is being placed on noise pollution. Also, regulations concerning job safety have become more stringent. Governmental regulations can vary from place to place in the United States.

- Availability of optimum equipment: There will normally be a number of pieces of equipment that will best fit the construction to be done. The availability of a wide variety of drilling equipment will vary with project location and the size of the drilled shafts.
- Experience and ingenuity of contractor: Many experienced contractors have developed techniques that significantly reduce the cost of construction. Inexperienced contractors, on the other hand, may submit a low bid because of misjudgment of the difficulty of a particular job.
- Cost of materials: A sharp rise in the cost of materials, such as steel prices, can significantly affect the cost of drilled shafts. Where material costs may fluctuate with time, a contingency may be included in contractor bids.
- Economic conditions and amount of construction activity: The cost of construction will vary depending on the availability of work. The principle of supply-and-demand works strongly in the drilled shaft industry.
- Insurance and bonding: The cost of these items appears to be having a larger and larger impact on the cost of construction,
- Cost of money and terms for payment: Interest rates have an impact on construction costs, and the schedule of payment to the contractor is an important factor.
- Terms of the contract: The cost of the construction will increase if the contractor is required to assume all risks, including the possibility that the actual site conditions are not the same as shown in the contract documents.
- General contractor's fees: Drilled shaft contractors are usually subcontractors to general contractors, who actually submit the bids for the project, so bid costs include the general contractor's fee for management, which can vary considerably among general contractors. A related factor is whether the general contractor is responsible for supplying and placing drilled shaft concrete. In some parts of the U.S. this is common practice; however, most drilled shaft contractors would prefer to have sole responsibility for the drilled shaft concrete in order to exert the appropriate quality control, an area in which they have more specialized knowledge and experience than many general contractors. A similar statement can be made regarding the supply and fabrication of rebar cages for drilled shafts. For large-diameter cages in particular, drilled shaft contractors are most familiar with the technical details of proper fabrication that will enable large cages to be lifted and placed safely without buckling or other potential problems.

To provide a picture of the relative impact of various factors on drilled shaft costs, a survey of drilled shaft contractors was made in 1997, with details reported in the previous version of this manual (O'Neill and Reese, 1999). Participants were asked to submit a bid price per linear foot of drilled shaft to construct 50 drilled shafts in each of three scenarios. "Construction" of a drilled shaft was defined to mean drilling, tying and placing the steel, and placing the concrete. While the bid prices are no longer valid, some of the conclusions based on the survey are still meaningful and provide insight on the relative influence of several important factors:

- construction of sockets in hard rock is about three times as expensive, on average, as constructing a shaft through dry overburden above rock.

- when the overburden is alluvium that is wet and filled with boulders and the socket is in a soft geomaterial, overburden construction is about twice as expensive per unit of length as construction of the soft socket.
- drilling slurry or full-length casing is about one-third more expensive than constructing through dry overburden
- The most uncertain cost is associated with excavating in hard rock; this likely reflects the different experiences of contractors with excavating the specific geologic formations in their respective market areas.

The above interpretations make it clear that the engineer needs to know enough about drilled shaft construction to anticipate the most likely method that the contractor will use.

### 22.3 COMMENTARY

Considering the number of variables affecting the cost of drilled shafts, there is no single formula or method that will provide highly accurate costs for a specific project prior to bidding. However, as described in the next section, cost information based on contracts awarded (historical information) can be used as a guide to make reasonable preliminary estimates for comparing drilled shafts to other foundation types. For final estimates prior to bid, historical price information combined with experience and knowledge of constructability and its influence on costs are the basis for making good estimates.

The cost of foundations in many instances is a relatively small cost of the entire project. Therefore, the prudent action is to select a contractor who has the necessary equipment, experienced personnel, and a record of high-quality construction so that the foundation can be built in rapid order and with good quality. In order to ensure this situation, some agencies have a requirement that the drilled shaft contractor be prequalified, which should aid in obtaining work of excellent quality.

### 22.4 HISTORICAL PRICE DATA AVAILABLE THROUGH THE INTERNET

Most state transportation agencies maintain data on low-bid unit prices, for contracts actually awarded, and may post this information on the internet. Historical price information is a valuable resource to engineers (and contractors) because it provides a snapshot of actual costs of drilled shafts in a particular state and, in some cases, in a particular geographic region within the state. Table 22-2 is an example of a low-bid summary table that was obtained from a website maintained by the Texas Department of Transportation (TxDOT). Texas provides a good example because TxDOT uses a relatively large number of drilled shafts and the market is competitive, with numerous qualified drilled shaft contractors bidding on TxDOT work.

Table 22-1 is a summary for the entire state. The geology across Texas varies considerably and, therefore, the subsurface conditions among jobs represented in Table 22-1 undoubtedly also varied considerably. Also, the lengths of drilled shafts, which are not tabulated, most likely varied over a wide range. It is important to recognize that the information in this type of table cannot be used to pinpoint costs for any particular drilled shaft project because many of the factors that influence the bids for a particular job (*e.g.*, subsurface conditions, length of shafts, access, etc.) are not identified. However, the data provide a general picture of costs relative to the diameter of the drilled shaft and, by comparing the latest bids with the 12-month moving average, a general idea of the pricing trends in Texas. The prices are clearly not linearly dependent upon shaft diameter. For example, the 12-month moving average price for "Drilled Shaft (36 inch)" [drilled shafts with a 36-inch diameter] is about \$175 per linear foot. The corresponding bid price for "Drilled Shaft (48 inch)" is about \$390 per linear foot.

**TABLE 22-1 LOW-BID TABLE FOR DRILLED SHAFTS, TEXAS DOT, STATEWIDE**  
 (Source: <http://www.dot.state.tx.us/business/avgd.htm>)

Description	Month Ending 6/30/2008		12-Month Moving		
	Quantity <sup>1</sup>	Average Bid <sup>2</sup>	Quantity <sup>1</sup>	Average Bid <sup>2</sup>	No. of Projects
Drilled Shaft (18 inch)	1,872	\$96.72	9,922	\$79.68	46
Drilled Shaft (24 inch)	418	\$141.20	34,477	\$125.53	46
Drilled Shaft (30 inch)	3,814	\$179.81	76,238	\$157.28	97
Drilled Shaft (36 inch)	2,232	\$224.99	74,730	\$176.22	73
Drilled Shaft (42 inch)	1,625	\$215.41	15,010	\$193.82	13
Drilled Shaft (48 inch)	14,798	\$270.13	37,844	\$390.74	19
Drilled Shaft (54 inch)	0	--	2,839	\$436.89	11
Drilled Shaft (60 inch)	0	--	2,600	\$417.99	5
Drilled Shaft (66 inch)	0	--	8,432	\$400.00	1
Drilled Shaft (72 inch)	0	--	401	\$444.93	2
Drilled Shaft (78 inch)	0	--	10,841	\$504.65	2
Drilled Shaft (84 inch)	0	--	30,210	\$696.60	24
Drilled Shaft, (non-reinforced 12 inch)	37	\$54.01	510	\$59.83	21
Drilled Shaft (Sign Mounts 12 inch)	0	--	831	\$58.19	15
Drilled Shaft (Sign Mounts 24 inch)	211	\$81.68	4,633	\$99.12	42
Drilled Shaft (Sign Mounts 30 inch)	38	\$112.00	759	\$146.30	11
Drilled Shaft (Sign Mounts 36 inch)	0	--	1,906	\$195.70	13
Drilled Shaft (Sign Mounts 42 inch)	0	--	1,286	\$247.87	10
Drilled Shaft (Sign Mounts 48 inch)	0	--	1,458	\$286.98	12
Drilled Shaft (Sign Mounts 54 inch)	18	\$377.17	1,173	\$369.72	12
Drilled Shaft (High Mast Pole 48 inch)	0	--	174	\$188.78	1
Drilled Shaft (High Mast Pole 54 inch)	0	--	464	\$281.94	2
Drilled Shaft (High Mast Pole 60 inch)	0	--	2,523	\$397.99	12
Drilled Shaft (High Mast Pole 66 inch)	0	--	1,091	\$545.24	3
Drilled Shaft (Roadway Illum. Pole 30 inch)	1,822	\$132.98	10,738	\$146.80	55
Drilled Shaft (Traffic Signal Pole 24 inch)	24	\$204.31	490	\$140.38	19
Drilled Shaft (Traffic Signal Pole 30 inch)	216	\$194.06	2,052	\$173.83	46
Drilled Shaft (Traffic Signal Pole 36 inch)	1,107	\$197.40	10,137	\$179.23	100
Drilled Shaft (Traffic Signal Pole 42 inch)	30	\$190.00	878	\$174.44	11
Drilled Shaft (Traffic Signal Pole 48 inch)	88	\$202.50	3,619	\$290.51	33
Drilled Shaft (18 inch HPC)	0	--	20	\$130.00	1
Drilled Shaft (96 inch)	0	--	1,052	\$1,000.00	1
Drilled Shaft (Sign Mounts 72 inch)	0	--	1,064	\$599.93	2
Drilled Shaft (90 inch)	0	--	725	\$500.00	1
Drilled Shaft (in Landfill 84 inch)	0	--	5,669	\$700.00	1

<sup>1</sup> All quantities are in linear feet      <sup>2</sup> All bid prices are in dollars per linear foot

Some agencies, including TxDOT, provide similar cost data broken down by administrative district within the state. Table 22-2 shows the low-bid prices for District 12, which is a coastal district in the vicinity of Houston. The time period is the same as that given in Table 22-1 for the entire state. The geology of District 12 is such that all subsurface profiles are soil only (no rock), and there are numerous water bearing sand and silt layers, which in almost all cases require the use of the wet method of construction. Therefore, the 12-month moving average bids are a fair representation of the relative costs of wet-method construction completely in soil in southeast Texas in 2007 and 2008 based on shaft diameter. Gaining access to information such as this, for projects in a given locality, is by far the best way to estimate costs.

**TABLE 22-2 LOW-BID TABLE FOR DRILLED SHAFTS, TEXAS DOT; DISTRICT 12 ONLY**  
(Source: <http://www.dot.state.tx.us/business/avgd.htm>)

Description	12-Month Moving Values		
	Quantity <sup>1</sup>	Average Bid <sup>2</sup>	No. of Projects
Drilled Shaft (18 inch)	134	\$100.00	1
Drilled Shaft (24 inch)	1,950	\$125.00	1
Drilled Shaft (30 inch)	6,072	\$104.48	5
Drilled Shaft (36 inch)	12,726	\$175.17	8
Drilled Shaft (42 inch)	1,100	\$261.00	1
Drilled Shaft (48 inch)	1,923	\$285.40	4
Drilled Shaft (54 inch)	640	\$270.48	2
Drilled Shaft (60 inch)	595	\$480.00	1
Drilled Shaft (78 inch)	10,421	\$500.00	1
Drilled Shaft (84 inch)	713	\$591.53	2
Drilled Shaft, (non-reinforced 12 inch)	126	\$62.99	3
Drilled Shaft (Sign Mounts 12 inch)	56	\$87.00	1
Drilled Shaft (Sign Mounts 24 inch)	170	\$119.12	3
Drilled Shaft (Sign Mounts 36 inch)	532	\$200.68	2
Drilled Shaft (Sign Mounts 54 inch)	445	\$443.97	2
Drilled Shaft (High Mast Pole 54 inch)	444	\$280.00	1
Drilled Shaft (High Mast Pole 60 inch)	407	\$442.76	2
Drilled Shaft (High Mast Pole 66 inch)	1,091	\$545.24	3
Drilled Shaft (Roadway Illum. Pole 30 inch)	254	\$110.00	1
Drilled Shaft (Traffic Signal Pole 24 inch)	8	\$150.00	1
Drilled Shaft (Traffic Signal Pole 30 inch)	10	\$90.00	1
Drilled Shaft (Traffic Signal Pole 36 inch)	2,602	\$166.00	13
Drilled Shaft (Traffic Signal Pole 42 inch)	679	\$172.96	6
Drilled Shaft (Traffic Signal Pole 48 inch)	1,878	\$296.98	8
Drilled Shaft (18 inch HPC)	20	\$130.00	1
Drilled Shaft (96 inch)	1,052	\$1,000.00	1
Drilled Shaft (Sign Mounts 72 inch)	456	\$664.25	1
Drilled Shaft (90 inch)	725	\$500.00	1

<sup>1</sup> All quantities are in linear feet <sup>2</sup> All bid prices are in dollars per linear foot



A second example of state-wide cost information for drilled shafts is presented in Table 22-3 for California, which also is a competitive market and a state that utilizes drilled shafts extensively. In addition to providing a comparison to costs in Texas, Table 22-3 shows how different subsurface conditions affect cost. For example, the average unit cost of 24-inch diameter rock sockets (\$604 per ft) based on two projects, was approximately four times the cost of 24-inch diameter shafts in soil (\$165 per ft) based on eight projects. A single project with 84-inch diameter shafts in soil shows higher cost (\$4,328 per ft) than the average cost of 84-inch diameter rock sockets (\$3,087 per ft) and higher costs than 96-inch diameter shafts in soil (\$1,612 per ft), suggesting that factors other than shaft size controlled the cost on this single project and that this anomalous case would not be representative of most drilled shaft projects involving 84-inch diameter shafts.

**TABLE 22-3 AVERAGE LOW-BID PRICES FOR DRILLED SHAFTS, 2007, CALTRANS**  
(Source: <http://www.dot.ca.gov/hq/esc/oe/awards/>)

Description	Average Values, 2007		
	Quantity <sup>1</sup>	Average Bid <sup>2</sup>	No. of Projects
Drilled Shaft (18 inch)	71,769	\$60.69	11
Drilled Shaft (24 inch)	17,163	\$147.73	8
Drilled Shaft (30 inch)	13,042	\$165.12	5
Drilled Shaft (36 inch)	878	\$294.19	2
Drilled Shaft (60 inch)	1,627	\$365.74	2
Drilled Shaft (84 inch)	492	\$4,327.95	1
Drilled Shaft (96 inch)	879	\$1,612.63	2
Drilled Shaft (120 inch)	243	\$11,462.05	1
Drilled Shaft (24 inch, rock socket)	866	\$604.03	2
Drilled Shaft (84 inch, rock socket)	673	\$3,086.80	2
Drilled Shaft (18 inch, barrier)	180	\$121.91	1
Drilled Shaft (18 inch, sound wall)	98,496	\$73.34	2
Drilled Shaft (24 inch, sound wall)	262	\$339.84	1
Drilled Shaft (24 inch, retaining wall)	600	\$219.45	1
Drilled Shaft (30 inch, sign foundation)	11	\$1,036.27	1
Drilled Shaft (36 inch, sign foundation)	46	\$1,219.14	1
Drilled Shaft (54 inch, for retaining wall)	922	\$1,049.83	10
Drilled Shaft (60 inch, sign foundation)	6,258	\$952.54	33

<sup>1</sup> All quantities are in linear feet <sup>2</sup> All bid prices are in dollars per linear foot

In using historical price data, it is also important to understand what items of work are included in the bid. Some states have separate bid items for drilled shaft excavation and drilled shaft concrete. Permanent steel casing may also be a separate bid item. Related cost items, such as mobilization and load testing, typically would be separate bid items. In addition, other non-shaft work items, such as site preparation, traffic control, concrete for pile caps, and others, are not included in the drilled shaft bid items, but may impact the total cost of drilled shaft foundation construction.

## 22.5 CONTRACTORS' COST COMPUTATION

The calculation of a bid for drilled shafts is made up of a number of components. Some costs are variable and are a function of the quantities of various items such as concrete, steel, excavation, etc. Other costs, such as the cost of engineering, bonding, and moving of equipment to and from the jobsite, are unique to each project, but are viewed as fixed because they do not vary with the quantity of work. Still other costs are viewed as overhead, which represents those costs which are ongoing to run the company regardless of the amount of work undertaken.

In the preparation of a quotation for drilled shafts, the Drilled Shaft Contractor will first examine the contract documents including geotechnical reports, boring logs, drawings, and specifications. Site conditions are then appraised from a site visit. The next step is to establish a tentative work plan that defines the methods to be used to complete the work, equipment to be used, and manpower requirements. Once a work plan is established, a quantity takeoff of materials to be used on the project can be calculated. This would include concrete, steel, NDT testing, slurry, and any other required materials.

Next, a rough schedule must be determined. A careful review of specifications must precede this step as often there are contract requirements which affect schedule. Examples are restrictions on drilling adjacent to recently poured shafts and time waiting for NDT testing and subsequent approval by the Resident Engineer.

### 22.5.1 Variable Costs

Labor: With the rough schedule in hand, the contractor can estimate labor costs including fringe benefits, payroll taxes, etc. for the project. The estimate must include allowances for anticipated overtime and may also include the cost of unproductive time because of inclement weather or other causes (see Contingencies).

Materials: The material takeoff is now priced by contacting suppliers. Material quantities include any anticipated overruns or waste materials such as the added concrete to overpour the shafts or that which may be anticipated by overbreak in the drilling process. Reinforcing steel and NDT testing are usually procured through subcontractors or suppliers if these items are to be included in the drilled shaft contractor's scope of work. NDT testing tubes are sometimes tied in the cages by the contractor's own forces, while other times the reinforcing steel supplier will provide these items. Either way, the estimator must appreciate where this item is included in the estimate.

Rented Equipment: Any rented equipment is priced based on quotations from suppliers and the cost calculated using the schedule developed at the start of the estimate.

Contractor-Owned Equipment: Several different approaches are used by contractors to incorporate the cost of their equipment in bids. Some contractors will develop very sophisticated data bases which permit them to identify all the costs of owning and running equipment. These include:

- Capital cost of purchase
- Cost of financing
- Cost of insurance
- Depreciation
- Major repairs
- Allowance for wear parts (cable, wear pads, filters etc)

- FOG ( fuel, oil, grease)
- Others

An estimate is made at the start of each year as to the number of operating hours the contractor anticipates for each piece of equipment. It is then possible to create an hourly equipment charge for each piece of equipment for use in estimating. These charges are then collected into an Equipment Costing account which, hopefully, will balance at the end of the year.

Other drilled shaft contractors may use published equipment costs such as Dataquest, Blue Book, or State Force-Account rates.

Still others may include only the fuel, oil and grease (FOG) required to operate a piece of equipment as a variable cost item in the estimate and place all other costs of equipment in the Overhead category. Whichever method is used, the drilled shaft contractor will then calculate equipment costs as a function of equipment hours, in the same way labor costs are estimated.

### **22.5.2 Jobsite Fixed Costs**

A separate estimate is prepared which calculates the cost of:

- Moves to and from the site
- Costs of establishing site trailers, etc.
- Bonding
- Engineering
- Supervision (some contractors will carry this in their variable costs)
- Project Management (some contractors will carry this in their Overhead)
- Other fixed costs

### **22.5.3 Overhead**

The cost of running the corporation must be written off over the year's work. Some drilled shaft contractors may cover overhead costs as a percentage of total job costs, others as a daily charge against major equipment. Still others may cover it in their markup. Overhead costs may include:

- Management salaries and benefits
- Administration such as Payroll, Accounts Receivable (AR), and Accounts Payable (AP)
- Telephones and Information Technology (IT)
- Over-runs or under-runs in the equipment costing account.
- Professional fees (legal, accounting, etc)
- Research and Development (R&D)
- Office rent and expenses
- Yard expenses (some contractors charge these back to each job)
- Equipment costs not charged to a project (see section on equipment costing)
- Others

#### **22.5.4 Contingencies**

Some contractors may make a separate estimate of contingent items while others may cover it in their markup. Contingencies include allowances for:

- Inclement weather
- Labor disruption
- Repair of anomalies
- Schedule disruption caused by others
- Potential differing site condition (DSC) claims which may be difficult to collect
- Potential Liquidated Damages
- Others

#### **22.5.5 Markup**

Some drilled shaft contractors may total all of the above costs and add a percentage markup to arrive at final pricing. Others may mark up different types of costs with different percentages based on the uncertainty of each item. For instance, for contractors who use this system, labor is traditionally much more volatile than subcontractor costs and so the markups reflect the uncertainty inherent.

It is not possible to quote reasonable markups without a very clear understanding of where a contractor's cost are being carried and if the markup includes some of those costs or whether all costs are separately calculated and the markup is only gross profit.

Markup will also vary based on market forces, the amount of backlog a contractor may or may not have, and the contractor's comfort level with the type of work, location of the work, and the track record of the client.

#### **22.5.6 Unit Prices**

Once the total bid price of the project is calculated, costs must be assigned to individual bid items which typically are designated by the owner. Some of the bid items will be in terms of unit prices, while others will be fixed or lump sum. The drilled shaft contractor must then make an appraisal of how volatile the job quantities may be. Are shafts likely to be longer or shorter than the engineer's estimate? Is more or less casing likely to be needed? The contractor will then make a decision as to how much of the total cost will be distributed across the unit priced items (those subject to fluctuation) and how much will be reserved against lump sum items such as Mobilization, Engineering, etc. This can be a very risky part of the estimating process and even a good estimate can result in significant losses if costs are spread in a manner which does not end up favorably when the final quantities are known.

#### **22.5.7 Other Considerations**

When comparing unit prices for an item of work, an engineer should have a very clear understanding of what is included and what is not included. Examples of items which could be included in a drilled shaft contract, but which may be supplied by the general contractor or other parties, are concrete, reinforcing

steel, permanent casing, NDT testing, and others. Unit prices should also not be viewed in a vacuum without an appraisal of the lump sum pricing associated with those units.

## 22.6 EXAMPLES

Two examples of prices bid for specific projects are given in this section. Both projects involved state DOT work in states where drilled shaft foundations are frequently used. The first project, in Texas, involved relatively small-diameter shafts and numerous moves. The second case, in Washington State, involved relatively large-diameter shafts for a light rail transit project with highly variable subsurface conditions.

### 22.6.1 Texas

A contract for drilled shaft construction was let in August, 2003, in Ellis County, TX, which is just south of Dallas. The project involved 11 bridges on Interstate 35, each of which crossed either a roadway or a creek. Drilled shafts were designed so the tips were founded in hard limestone of the Austin Chalk. Depth of the limestone varied and was encountered close to the ground surface at some locations but overlain by up to 30 ft of plastic clay at other sites. The primary foundations were 30-inch and 36-inch diameter drilled shafts, with a small number of 18-inch diameter shafts for support of abutment wingwalls. Table 22-4 summarizes the shaft characteristics and contract unit prices. The bid prices included all excavation (unclassified), steel, and concrete. Reinforcing steel cages are full length, with six No. 6 bars in the 18-inch shafts, eight No. 9 bars in the 30-inch shafts, and ten No. 9 bars in the 36-inch shafts. The project was completed successfully during 2004-2005.

The bid prices for this project were 20 to 25 percent lower than the statewide average at the time (M. McClelland, personal communication, 2008). This may be attributable to several factors. A large number of qualified drilled shaft contractors operate in the Dallas/Fort Worth area, making for a highly competitive market. A large number of concrete plants are also nearby. Subsurface conditions were relatively uniform and predictable, and well-known to contractors in the area. On the other hand, all of the bridges were constructed in three phases to accommodate the traffic control plan, so there were numerous mobilizations. For comparison, a similar job in the same time period in northeast Texas involving five bridges and 3,888 linear feet of 30-inch diameter shafts resulted in a bid price of \$121 per linear foot. These examples illustrate the strong influence of local market conditions on actual costs of drilled shafts.

**TABLE 22-4 SUMMARY STATISTICS ON DRILLED SHAFT CONTRACT, ELLIS COUNTY, TX (data from M. McClelland, TxDOT)**

Diameter (inches)	No. of Shafts	Total Linear Feet	Length		Bid Price (\$/ft)
			Range (ft)	Average (ft)	
18	38	760	8 - 27	20	40.00
30	86	1,692	9 - 30	20	70.00
36	302	6,628	9 - 43	21	80.00

## 22.6.2 Washington

A major Light Rail Project was constructed between the summer of 2005 and spring of 2007 in Seattle, WA (A. Rasband, personal communication, 2008). As designed, the project consisted of 168 drilled shafts with diameters of 6.5 ft, 8.2 ft, and 9.8 ft, and ranging in depth from 35 ft to 122 ft. Initially, only some of the shafts were specified to be constructed using the full-depth casing method of construction, with casing installed by oscillator (as described in Chapter 4). Ultimately, however, all of the shafts were constructed using the oscillated casing method. The reason is that over the length of the project, approximately 5.5 miles, subsurface conditions varied considerably. Approximately one-third of the shafts were terminated in rock, predominately sandstone and andesite, but also highly variable with respect to depth to rock and rock mass characteristics. The remainder were terminated in dense glacially overridden soils. Groundwater conditions varied from dry to artesian aquifers. The full-depth casing method provided the contractor with the ability to install shafts in all of the subsurface profiles encountered. The 6.5-ft diameter shafts were constructed using an oscillator attached to a large top-drive drill rig. The 8.2-ft and 9.8-ft diameter shafts were constructed using a hydraulic oscillator attached to a crane. During the project a change order was negotiated to add ten additional 6.5-ft diameter shafts and fifteen additional 9.8-ft diameter shafts. Of the final number of shafts constructed, only one shaft exhibited an anomaly by CSL testing. The anomalous reading helped to identify a zone at a depth of 20 ft at which an unforeseen charged aquifer resulted in washout of the concrete upon extraction of the casing. The defective concrete was repaired. Reinforcing steel was furnished, fabricated, and delivered adjacent to each shaft location by the general contractor, and was therefore not included in the drilled shaft contractor's bid. Concrete was supplied by the drilled shaft contractor and was placed by tremie. Most shafts required a water head to offset groundwater pressures. The contract value was \$14,077,743 which included 25,151 cubic yards of drilled shaft concrete for a unit price of \$560 per cubic yard of completed drilled shaft.

## 22.7 SUMMARY

The factors that determine costs of drilled shaft construction are identified and discussed. Site conditions, including both subsurface and surface features, often are the most significant factors influencing the overall costs. The use of cost data from recent projects is shown to be a valuable tool for making engineering cost estimates; however, the cost of drilled shafts can be highly project-specific and there is no single reliable method of predicting actual costs. The general process used by contractors for estimating drilled shaft costs is outlined and discussed. Having a general idea of how contractors prepare bid costs can be of benefit to engineers in making estimates of costs for planning purposes and for comparing various foundation options.

## CHAPTER 23

### REFERENCES

- Abu-Hejleh, N., O'Neill, M.W., Hanneman, D., and Atwoll, W.J. (2003). "Improvement of the Geotechnical Axial Design Methodology for Colorado's Drilled Shafts Socketed in Weak Rock." Report No. CDOT-DTD-R-2003-6, Colorado Department of Transportation, Denver, 192 p.
- Abghari, A. and Chai, J. (1995). "Modeling of Soil-Pile-Superstructure Interaction for Bridge Foundations," Geotechnical Special Publication No. 51, Performance of Deep Foundations Under Seismic Loading, J.P. Turner, Editor, ASCE, New York, NY, pp. 45-59.
- Acker, W.L. III, (1974), "Basic Procedures for Soil Sampling and Core Drilling, Acker Drill Company, Inc.," Scranton, PA, 246 p.
- ADSC: The International Association of Foundation Drilling (1999), "Standards and Specifications for the Foundation Drilling Industry", Dallas, Texas.
- ADSC: The International Association of Foundation Drilling (1995)." Standards and Specifications for the Drilled Shaft Industry", Dallas, TX.
- ADSC: The International Association of Foundation Drilling and DFI: The Deep Foundations Institute (ADSC/DFI) (1989). "Drilled Shaft Inspector's Manual, Joint Caisson - Drilled Shaft Committee of the ADSC", Dallas, Texas.
- Allen, T. M., (2005). "Development of Geotechnical Resistance Factors and Downdrag Load Factors for LRFD Foundation Strength Limit State Design," Publication No. FHWA-NHI-05-052, Federal Highway Administration, Washington, DC, 41 p.
- Allen, T.M., Nowak, A.S., and Bathurst, R.J. (2005). "Calibration to Determine Load and Resistance Factors for Geotechnical and Structural Design," Transportation Research Circular E-C079, Transportation Research Board, Washington, DC, 83 p.
- American Association of State Highway and Transportation Officials (AASHTO) (2008). "Guide Drilled Shaft Construction Specifications," (draft), FHWA (2008). Joint Committee of FHWA, ADSC: International Association of Foundation Drilling, and AASHTO.
- American Association of State Highway and Transportation Officials (AASHTO) (2008), AASHTO Update to Specifications for Section 5 - Drilled Shafts, Draft by Technical Committee T-15, Personal Communication, June, 2008.
- American Association of State Highway and Transportation Officials (AASHTO) (2007a). "AASHTO LRFD Bridge Design Specifications, Customary U.S. Units, 4th Ed., Section 10, 'Foundations'", Washington, D.C.
- American Association of State Highway and Transportation Officials (AASHTO) (2007b), "Updated Seismic Provisions to LRFD Specifications", April 2007, available online as of Jan 2008, at: <http://bridges.transportation.org/sites/bridges/docs/LRFD%20Seismic%20Ballot%20Item.pdf>

- American Association of State Highway and Transportation Officials (AASHTO) (2007c). "AASHTO Guide Specifications for LRFD Seismic Bridge Design", prepared by R. A. Imbsen, May 2007, available online as of Jan 2008, at: <http://bridges.transportation.org/sites/bridges/docs/2007%20Ballot%20%20Seismic%20Guidelines.pdf>
- American Association of State Highway and Transportation Officials (AASHTO) (2004), "Standard R 27-01, Standard Recommended Practice for Assessment of Corrosion of Steel Piling for Non-Marine Applications", AASHTO Standard Specifications for Transportation Materials and Methods of Sampling and Testing, Part 1B: Specifications, 24th Edition.
- American Association of State Highway and Transportation Officials (AASHTO) (1992), "Standard Specifications for Transportation Materials and Methods of Sampling and Testing, Part II", Washington, D.C.
- American Association of State Highway and Transportation Officials (AASHTO) (1991). "Guide Specification and Commentary for Vessel Collision Design of Highway Bridges", GVCB-1.
- American Association of State Highway and Transportation Officials (AASHTO) (1988). "Manual on Subsurface Investigations", Washington, D.C.
- American Concrete Institute (ACI) 318, (2008) "Building Code Requirements for Structural Concrete and Commentary", American Concrete Institute, Detroit, Michigan.
- American Concrete Institute (ACI) 116R, (2005) "Cement and Concrete Terminology", American Concrete Institute, Detroit, Michigan.
- American Concrete Institute (ACI) 237 (2005), "Self-consolidating concrete", Emerging technology document, American Concrete Institute, Farmington Hills, Michigan.
- American Concrete Institute (ACI) 212.3, (2004) "Chemical Admixtures for Concrete", American Concrete Institute, Detroit, Michigan.
- American Concrete Institute (ACI) 336.1, (2001). "Standard Specification for the Construction of Drilled Piers", American Concrete Institute, Detroit, Michigan.
- American Concrete Institute (ACI) (2001), "Specification for the Construction of Drilled Shafts", American Concrete Institute Publication No. 336.1R-01, Farmington, MI.
- American Concrete Institute (ACI) 223R, (2000) "Guide for the Use of Silica Fume in Concrete", American Concrete Institute, Detroit, Michigan.
- American Petroleum Institute (API) (2003). "Recommended Practice for Field Testing Water-Based Drilling Fluids," API RP 13B-1/ISO 10414-1, 3<sup>rd</sup> Ed., American Petroleum Institute, Washington, D.C., 82 p.
- Amir, J.M. (2002). "Single-Tube Ultrasonic Testing of Pile Integrity," Geotechnical Special Publication No. 116, Proceedings of Deep Foundations 2002, An International Perspective on Theory, Design, Construction, and Performance, ASCE, Orlando, FL.



- Amir, J.M. and Amir, E.I. (2009). "Capabilities and Limitations of Cross Hole Ultrasonic Testing of Piles," Geotechnical Special Publication No. 185, Contemporary Topics in Deep Foundations, Selected Papers from the 2009 International Foundation Congress and Equipment Expo, Ed. by M. Iskander, D.F. Laefer, and M.H. Hussein, ASCE, Reston, VA, pp. 536-543.
- ASTM C 150 (2007). "Specifications for Portland Cement," Annual Book of ASTM Standards, Part 14, ASTM International, West Conshohocken, Pennsylvania.
- ASTM C 1621 (2006). Standard Test Method for Passing Ability of Self-Consolidating Concrete by J-Ring. ASTM International, West Conshohocken, Pennsylvania.
- ASTM C 1610 (2006). Standard Test Method for Static Segregation of Self-Consolidating Concrete Using Column Technique. ASTM International, West Conshohocken, Pennsylvania.
- ASTM C 1611 (2005). Standard Test Method for Slump Flow of Self-Consolidating Concrete. ASTM International, West Conshohocken, Pennsylvania.
- ASTM C 87 (2005). "Standard Test Method for Effect of Organic Impurities in Fine Aggregate on Strength of Mortar," Annual Book of ASTM Standards, Vol. 4.02, ASTM International, West Conshohocken, Pennsylvania.
- ASTM C 494 (2005). "Standard Specifications Chemical Admixtures for Concrete," Annual Book of ASTM Standards, Vol. 4.02, ASTM International, West Conshohocken, Pennsylvania.
- ASTM C 586 (2005). "Standard Test Method for Potential Alkali Reactivity of Carbonate Rocks for Concrete Aggregates (Rock Cylinder Method)," Annual Book of ASTM Standards, Vol. 4.02, ASTM International, West Conshohocken, Pennsylvania.
- ASTM C 618 (2005). "Standard Specification for Coal Fly Ash and Raw or Calcinated Natural Pozzolan for Use as a Mineral Admixture in Portland Cement," Annual Book of ASTM Standards, Vol. 4.02, ASTM International, West Conshohocken, Pennsylvania.
- ASTM C 989 (2005). "Standard Specification for Ground Granulated Blast-Furnace Slag for Use in Concrete and Mortars," Annual Book of ASTM Standards, Vol. 4.02, ASTM International, West Conshohocken, Pennsylvania.
- ASTM C 1260 (2005). Standard Test Method for Potential Alkali Reactivity of Aggregates (Mortar-Bar Method). ASTM International, West Conshohocken, Pennsylvania.
- ASTM C 1293 (2005). Standard Test Method for Determination of Length Change of Concrete Due to Alkali-Silica Reaction. ASTM International, West Conshohocken, Pennsylvania.
- ASTM C 33 (2003). "Standard Specifications for Concrete Aggregates," Annual Book of ASTM Standards, Vol. 4.02, ASTM International, West Conshohocken, Pennsylvania.
- ASTM C 227 (2003). "Standard Test Method for Potential Alkali Reactivity of Cement- Aggregate Combinations," Annual Book of ASTM Standards, Vol. 4.02, ASTM International, West Conshohocken, Pennsylvania.

- ASTM C 289 (2003). "Standard Test Method for Potential Alkali-Silica Reactivity of Aggregates (Chemical Method)," Annual Book of ASTM Standards, Vol. 4.02, ASTM International, West Conshohocken, Pennsylvania.
- ASTM C 295 (2003). "Standard Guide for Petrographic Examination of Aggregate for Concrete," Annual Book of ASTM Standards, Vol. 4.02, ASTM International, West Conshohocken, Pennsylvania.
- ASTM (2002). Annual Book of ASTM Standards, Section 4, Volume 4.09, American Society for Testing and Materials, West Conshohocken, PA.
- ASTM C 260 (2001). "Standard Specification for Air-Entraining Admixtures for Concrete," Annual Book of ASTM Standards, Vol. 4.02, ASTM International, West Conshohocken, Pennsylvania.
- ASTM (2000). "Annual Book of ASTM Standards", American Society for Testing and Materials, Philadelphia, PA.
- ASTM (1997), "Annual Book of ASTM Standards", Philadelphia, PA, 1997.
- ASTM (1996). "Standard Test Method for Measurement of Soil Potential (Suction) Using Filter Paper (D 5298)," Annual Book of Standards, American Society for Testing and Materials, Vol. 4.09, West Conshohocken, PA, pp. 154 - 159.
- Anderson, J.B., Townsend, F.B., and Grajales, B. (2003). "Case History Evaluation of Laterally Loaded Piles," Journal of Geotechnical and Geoenvironmental Engineering, ASCE, Vol. 129, No. 3, pp. 187-196.
- Ashour, M., and Norris, G. (2003). "Lateral Loaded Pile Response in Liquefiable Soil." Journal of Geotechnical and Geoenvironmental Engineering, Vol. 129, No. 5, 404-414.
- Ashour, M., Norris, G., and Pilling, P. (1998). "Lateral Loading of a Pile in Layered Soil Using the Strain Wedge Model," Journal of Geotechnical and Geoenvironmental Engineering, ASCE, Vol. 124, No. 4, pp. 303-315.
- Ata, A. and O'Neill, M. W. (1997). "Characterization of the Effect of Polybore TMP Polymer on the Construction and Performance of Drilled Shaft Foundations," Report to Baroid Drilling Fluids, Inc., University of Houston, Houston, Texas, May, 1997.
- Armour, T., Groneck, P., Keeley, J., and Sharma, S. (2000). "Micropile Design and Construction Guidelines Implementation Manual," Report No. FHWA-SA-97-070, 376p.
- Axtell, P.J. and Stark, T.D. (2008) "Increase in Shear Modulus by Soil Mix and Jet Grout Methods". A paper submitted for review and possible publication in The Journal of the Deep Foundations Institute.
- ATC/MCEER Joint Venture (2002). "Comprehensive Specification for the Seismic Design of Bridges," NCHRP Report 472, Transportation Research Board, National Academy Press, Washington, D.C., 47 p.
- ATC 32-1 (1996), "Improved Seismic Design Criteria for California Bridges": Resource Document, Applied Technology Council.

- Bailey, J.D., Schindler, A.K., and Brown, D.A. (2005). "An evaluation of the use of self-consolidating concrete (SCC) for drilled shaft applications". Research Report, Highway Research Center, Auburn University, Alabama, 162 p.
- Baker, C. N., Jr., Echevarria, F. A., and Gnaedinger, J. P. (1982). "Use of Grouting in Caisson Construction," in Proceedings, Specialty Conference on Grouting in Geotechnical Engineering, New Orleans, LA, American Society of Civil Engineers, February.
- Baker, C. N., Jr., and Gnaedinger, J. P. (1960). "Investigation of the Concrete Free Fall Method of Placing High Strength Concrete in Deep Caisson Foundation, Soil Testing Services, Inc.", Chicago, 1960, 111 pp. (Report available from ADSC, Dallas, Texas.)
- Barker, R.M., Duncan, J.M., Rojiani, K.B., Ooi, P.S.K., Tan, C.K., and Kim, S.G. (1991). "Manuals for the Design of Bridge Foundations." NCHRP Report 343, Transportation Research Board, National Research Council, Washington, DC, 308 p.
- Baker, C.N., Jr., Parikh, G., Briaud, J-L, Drumright, E.E., and Mensah, F. (1993). "Drilled Shafts for Bridge Foundations," Report No. FHWA-RD-92-004, Federal Highway Administration, McLean, VA, August.
- Barker, W. R., and Reese, L. C. (1970). "Load-Carrying Characteristics of Drilled Shafts Constructed with the Aid of Drilling Fluids," Research Report No. 89-9, Center for Highway Research, The University of Texas at Austin, August, 326 pp.
- Barker, W. R., and Reese, L. C. (1969). "Instrumentation for Axial Load in Drilled Shafts," Research Report No. 89-6, Center for Highway Research, The University of Texas at Austin, November, 102 pp.
- Bartholomew, R. F. (1980). "The Protection of Concrete Piles in Aggressive Ground Conditions: An International Appreciation," in Proceedings, Conference on Recent Developments in the Design and Construction of Piles, ICE, London, pp. 131 - 141.
- Bastian, C. E. (1970). "Effect of Vibration on Freshly Poured Concrete," Foundation Facts, Raymond International, Inc., Vol. VI, No. 1, pp. 14 - 17.
- Baycan, S. (1996). "Field Performance of Expansive Anchors and Piles in Rock", Thesis Submitted for the Degree of Doctor of Philosophy in the Department of Civil Engineering, Monash University, Clayton, Victoria, Australia.
- Beresford, J. J., Cashman, P. M., and Hollarnby, R. G. (1989). "The Merits of Polymeric Fluids as Support Slurries," in Proceedings, International Conference on Piling and Deep Foundations, London, Vol. 1, Ed. by J. B. Burland and J. M. Mitchell, Balkema, Rotterdam.
- Birmingham, P. and Janes, M. (1989). "An Innovative Approach to Load Testing of High Capacity Piles." Proceedings of the International Conference on Piling and Deep Foundations, Volume 1, J.B Burland and J.M. Mitchell Editors, A.A. Balkema Publishers, Rotterdam, 409-413.
- Bieniawski, Z.T. (1989). "Engineering Rock Mass Classifications", Wiley, New York.

- Bishop, A. W., Alpan, I., Blight, G.E., and Donald, I.B. (1960). "Factors Controlling the Strength of Partially Saturated Cohesive Soils.", Proceedings, Research Conference on Shear Strength of Cohesive Soils, Boulder/CO, ASCE, pp. 503-532.
- Bjerrum, L. (1972). "Embankments on soft ground." Proceedings, Performance of Earth and Earth-Supported Structures, Vol. II, (Purdue Univ. Conf.), ASCE, Reston/VA, pp. 1-54.
- Bolton, M.D. (1986). "The strength and dilatancy of sands", *Geotechnique*, Vol. 36 (1), pp. 65-78.
- Bowles, J.E. (1988). "Foundation Analysis and Design", Second Edition, McGraw-Hill Book Company, New York.
- Brandenberg, S.J., Boulanger, R.W., Kutter, B.L., and Chang, D. (2007), "Static Pushover Analyses of Pile Groups in Liquefied and Laterally Spreading Ground in Centrifuge Tests," *Journal of Geotechnical and Geoenvironmental Engineering*, Vol. 133, No. 9, 1055-1066.
- Briaud, J.-L., Chen, H.-C., Li, Y., Nurtjahyo, P. and Wang, J. (2003), "Complex Pier Scour and Contraction Scour in Cohesive Soils," NCHRP Report 24-15, National Cooperative Highway Research Program, Research Board, Washington, D.C, 290 p.
- Briaud J.-L., Ting F., Chen H.C., Cao Y., Han S.-W., Kwak K., (2001), "Erosion Function Apparatus for Scour Rate Predictions," *Journal of Geotechnical and Geoenvironmental Engineering*, ASCE, Vol.127, No. 2, pp.105-113.
- Briaud, J.-L. and Tucker, L. M. (1997). "Design and Construction Guidelines for Downdrag on Uncoated and Bitumen-Coated Piles," NCHRP Report No. 393, Transportation Research Board, Washington, DC, 118 pp.
- Briaud, J.L. (1992), "The Pressuremeter". A.A. Balkema, Rotterdam, The Netherlands.
- Brown, D. A. (2008), "Drilled Shaft Installation and Load Test," Memo from D.A. Brown and Associates, LLC to P.B. World, Inc., dated Feb 8, 2009, 6 p.
- Brown, D. (2007), "Construction of Large Drilled Shafts," Second Annual Mike O'Neill Lecture, Houston Tx, 14p
- Brown, D. (2007). "Rapid Lateral Load Testing of Deep Foundations." *Journal of the Deep Foundations Institute*, Vol. 1, No. 1, pp. 54- 62.
- Brown, D. (2007). "Rapid Lateral Load Testing of Deep Foundations." *Journal of the Deep Foundations Institute*, Vol. 1, No. 1, pp. 54- 62.
- Brown, D. A. (2002). "The Effect of Construction on Axial Capacity of Drilled Foundations in Piedmont Soils," *Journal of Geotechnical and Geoenvironmental Engineering*, ASCE, Vol. 128(12), pp 967-973.
- Brown, D. (1994). "Evaluation of Static Capacity of Deep Foundations from Statnamic Testing." *ASTM, Geotechnical Testing Journal*, GTJODJ, Vol. 17, No. 4, 403-414.

- Brown, D.A, (1990). "Construction and Design of Drilled Shafts in Hard Pinnacled Limestones," *Transportation Research Record No. 1277*, Transportation Research Board, Washington, D.C., pp. 148-152.
- Brown, D. A. and Camp, W.M. (2002). "Lateral Load Testing Program for the Cooper River Bridge, Charleston, SC" Geotechnical Special Publication No. 116, ASCE, pp. 95-109.
- Brown, D., Dapp, S., Thompson, R., and Lazarte, C. (2007), "Design and Construction of Continuous Flight Auger Piles," Geotechnical Engineering Circular No. 8, Federal Highway Administration Office of Technology Application, Office of Engineering/Bridge Division, 294p.
- Brown, D.A. and Kahle, K (2002). "Performance of Laterally Loaded Drilled Sockets Founded in Weathered Quartzite," Highway Research Center Report to Alabama DOT, Project B-425, Nov., 2002.
- Brown D.A., Schindler A.K, Bailey J.D, Goldberg A.D., Camp W.M., Holley D.W. (2007), "Evaluation of self-consolidating concrete for drilled shaft applications at the Lumber River bridge project, South Carolina," *Journal of the Transportation Research Board, TRR No. 2020*, pp. 67-75.
- Brown, D. A., and Shie, C-F (1991). "Modification of p-y Curves to Account for Group Effects on Laterally Loaded Piles," Geotechnical Special Publication No. 27, Ed. by F. G. McLean, D. A. Campbell, and D. W. Harris, ASCE, Vol. 1, pp. 479 - 490.
- Brown, D. A., Reese, L. C., and O'Neill, M. W. (1987). Behavior of Large-Scale Pile Group Subjected to Cyclic Lateral Loading, *Journal of Geotechnical Engineering*, Vol. 113, No. 11, November, pp. 1326 - 1343.
- Bru, J-P, Delude, P., and Laperna, P. (1991). *Etudes expérimentales sur le Bétonnage des Pieux Forés, Série Géotechnique GT 45, des Laboratoires des Ponts et Chaussées, Paris (in French), 62 PP.*
- Bruce, D. (2000). "An Introduction to Deep Soil Mixing Methods as Used in Geotechnical Applications," FHWA-RD-99-138, 135p.
- Buckle, I.G., Yen, W-H. P., and Roberts, J.E. (2006). "Seismic Design and Retrofit of Bridges Using Load and Resistance Factor Design: Past, Present, and Future," *Transportation Research Circular E-C104: Fifty Years of Interstate Structures: Past, Present, and Future*, Transportation Research Board, National Research Council, Washington, D.C., pp. 79-95.
- Bury, M.A. and B.J. Christensen. (2003). "The Role of Innovative Chemical Admixtures in Producing Self-Consolidating Concrete". In *First North American Conference on the Design and Use of Self-Consolidating Concrete 12-13 November 2002*, edited by Surendra Shah, Joseph Daczko, and James Lingscheid, 137-140. Addison, Illinois: Hanley-Wood.
- Bustamante, M., and Gouvenot, D. (1983), "Grouting: A Method Improving the Bearing Capacity of Deep Foundation," in *Proceedings, Eighth European Conference on Soil Mechanics and Foundation Engineering, Helsinki, Vol. 1*, pp. 131 - 134.
- Butler, H. D. (1973). "A Study of Drilled Shafts Constructed by the Slurry Displacement Method", Bridge Division, Texas Highway Department, Austin, Texas, February.

- C. Felice & Company (2002). "Draft Drilled Shaft Acceptance Criteria," October 12, 2002, 8 p. [http://www.lachel.com/DRAFT\\_drilled-shaft-acceptance-criteria.pdf](http://www.lachel.com/DRAFT_drilled-shaft-acceptance-criteria.pdf)
- Caltrans (2010). "Gamma-Gamma Logging (GGL): Frequently Asked Questions About Gamma-Gamma Logging," <http://www.dot.ca.gov/hq/esc/geotech/ft/gamma.htm>.
- Caltrans Seismic Design Criteria,(2006).
- Caltrans-ADSC West Coast Chapter, (2007). "Standard CIDH Pile Anomaly Mitigation Plans A & B", April 30, 2007, 18p.
- Camp, W. A., Brown, D. A., and Mayne, P. W. (2002). "Construction Methods Effects on Drilled Shaft Axial Performance," Deep Foundations 2002, Geotechnical Special Publication No. 116, M.W. O'Neill and F.C. Townsend, eds., ASCE, Reston, VA, pp. 193-208.
- Canadian Geotechnical Society (1995), "Canadian Foundation Engineering Manual", 2<sup>nd</sup> Edition, Ottawa, 456 p.
- Canadian Geotechnical Society (1985), Canadian Foundation Engineering Manual, 2nd ed., Ottawa, Canada, 456 pp.
- Carter, J.P. and Kulhawy, F.H. (1988). "Analysis and Design of Drilled Shaft Foundations Socketed into Rock," Report EL-5918, Electric Power Research Institute, Palo Alto, CA, 188 p.
- Cavusoglu, E., Nam, M.S., O'Neill, M.W., and McClelland, M. (2004). "Multi-Method Strength Characterization for Soft Cretaceous Rocks in Texas," Geotechnical Special Publication No. 124, GeoSupport 2004, J.P. Turner and P.W. Mayne, Editors, ASCE, Reston, VA, pp. 199-210.
- Cernak, B. (1976). "The Time Effect of Suspension on the Behavior of Piers," Proceedings, Sixth European Conference on Soil Mechanics and Foundation Engineering, 1.1, Vienna, pp. 111-114.
- Chamberlain, S.E. (1891), "City Hall Foundations, Kansas City," Proceedings of the 24<sup>th</sup> Annual Convention of the American Institute of Architects, Oct., 1890.
- Chen, Y-J, and Kulhawy, F.H. (2002), "Evaluation of Drained Axial Capacity for Drilled Shafts," Geotechnical Special Publication No. 116, Deep Foundations 2002, M.W. O'Neill and F.C. Townsend, Editors, ASCE, Reston, VA, pp. 1200-1214.
- Cheney, R.S. and Chassie, R.G. (2002), "Soils and Foundation Workshop Manual", Second Edition. Report No. HI-88-009, U.S. Department of Transportation, Federal Highway Administration, Office of Engineering, Washington, D.C., 395p.
- Chicago Committee on High-Rise Buildings (1986). "Full-Scale Load Test on Caisson Foundation," Report No. 10, October, Chicago Committee on High-Rise Buildings, Chicago, IL.
- Chilingarian, G. V., and Vorabutr, P. (1981). "Drilling and Drilling Fluids", Elsevier, Amsterdam.
- Cooke, R.W. (1979). "Load Transfer from Bored, Cast-In-Situ Piles in London Clay," Behavior of Deep Foundations, STP 670, R. Lundgren, ed., American Society for Testing and Materials, Philadelphia, PA, pp. 250-263.

- Cox, W. R., Reese, L. C., and Grubbs, B. R. (1974). "Field Testing of Laterally Loaded Piles in Sand," in Proceedings, Sixth Offshore Technology Conference, Dallas, Texas, Paper No. 2079.
- Crapps, D.K., and Schmertmann, J.H. (2002). "Compression Top Load Reaching Shaft Bottom – Theory versus Tests," Proceedings, International Deep Foundations Congress, Orlando, FL, ASCE.
- Dapp, S.D., Muchard, M., Brown, D.A., (2006). "Experience with Base Grouted Drilled Shafts in the United States", Proc., 10th Int'l Conf. on Piling and Deep Foundations, Amsterdam.
- Darley, H. C. and Gray, G. R. (1988). "Composition and Properties of Drilling and Completion Fluids", Fifth Edition, Gulf Publishing Company, Houston, TX, 643 p.
- Davis, A.G. (1995). "Nondestructive Evaluation of Existing Deep Foundations," Journal of the Performance of Constructed Facilities, ASCE, Vol. 9, No. 1, February, pp. 57 - 74.
- Davis, A.G., and Hertlein, B.H. (1991). "Development of Nondestructive Small-Strain Methods for Deep Foundations: A Review," Transportation Research Record 1331, Transportation Research Board, Washington, D.C., pp. 15-20.
- Deere, D.U., and Deere, D.W. (1989). "Rock Quality Designation (RQD) After Twenty Years." Contract Report GL-89-1, U. S. Army Engineer Waterways Experiment Station, Vicksburg, MS.
- Dowding, C. (2000), "Construction Vibrations", Second Edition. 610 pages.
- Dunnavant, T. W., and O'Neill, M. W. (1989). "Experimental p-y Model for Submerged, Stiff Clay, Journal of Geotechnical Engineering, ASCE, Vol. 115, No. 1, January, pp. 95 - 114.
- Duncan, J.M. (2000). "Factors of Safety and Reliability in Geotechnical Engineering." Journal of Geotechnical and Geoenvironmental Engineering, Vol. 126, No. 4, pp. 307-316.
- Elias, V., Welsh, J., Warren, J., Lukas, R., Collin, J.G., and Berg, R.R. (2004), "Ground Improvement Methods Participants Notebook", Federal Highway Administration FHWA NHI-04-001.
- Elias, V., B. R. Christopher, and R. R. Berg, (2001), "Mechanically Stabilized Earth Walls and Reinforced Soil Slopes Design & Construction Guidelines", Report No. FHWA-NHI-00-043, National Highway Institute, Federal Highway Administration, U.S. Department of Transportation, Washington, D.C., 387p.
- Elremaily, A., and A. Azizinamini (2002), "Behavior and strength of circular concrete-filled tube columns," Journal of Constructional Steel Research 58 (2002) 1567–1591, Elsevier.
- Ensoft, Inc. (2004), "LPILE5 for Windows", Ensoft, Inc., Austin, Texas.
- Essex, Randall J., Chairman (2007). "Geotechnical Baseline Reports for Construction: Suggested Guidelines", The Technical Committee on Geotechnical Reports of the Underground Technology Research Council, Sponsored by the Construction Institute of ASCE and American Institute of Mining, Metallurgical, and Petroleum Engineers, ASCE. Reston, VA, 62 p.
- Farmer, I.W. and Goldberger, M. (1969), "Effect of Bentonite on the Skin Friction of Bored Piles," Internal Report, Cementation Research, Ltd.

- Farr, J.S. (1974), "Study of the Load Capacity of Plain Concrete Underreams for Drilled Shafts," Master's Thesis, Department of Civil Engineering, The University of Texas at Austin, Austin, Texas, May.
- Federal Highway Administration (FHWA) (2008a). "Application of Geophysical Methods to Highway Related Problems," Federal Lands Highway Program, available online: <http://www.cflhd.gov/geotechnical>.
- Federal Highway Administration (FHWA) (2008b). "Geotechnical Engineering Notebook". FHWA Geotechnical Guidelines GT1 –GT16. available online: <http://www.fhwa.dot.gov/engineering/geotech/index.cfm>.
- Federal Highway Administration (FHWA) (2006) "Design and Construction of Driven Pile Foundations, Reference Manual – Volume 1", FHWA-NHI-05-042, Washington, D.C.
- Federal Highway Administration (FHWA) (2006a) "Design and Construction of Driven Pile Foundations, Reference Manual – Volume II", FHWA-NHI-05-043, Washington, D.C.
- Federal Highway Administration (FHWA) (2006b) "Workbook for Subsurface Investigation Inspection Qualification", FHWA-NHI-05-035, Washington, D.C.
- Federal Highway Administration (FHWA) (2005) "Soil Slope and Embankment Design", FHWA-NHI-05-023, Washington, D.C.
- Federal Highway Administration (FHWA) (2005b) "Earth Retaining Structures", FHWA-NHI-05-046, Washington, D.C.
- Federal Highway Administration (FHWA) (2005c) "Micropile Design and Construction", FHWA-NHI-05-039, Washington, D.C.
- Federal Highway Administration (FHWA) (2004) "Ground Improvement Methods", FHWA-NHI-04-001, Washington, D.C.
- Federal Highway Administration (FHWA) (2003). "Checklist and guidelines for review of geotechnical reports and preliminary plans and specifications" Report FHWA-ED-88-053, Washington D.C. Also available online: <http://www.fhwa.dot.gov/engineering/geotech/pubs/reviewguide/checklist.pdf>
- Federal Highway Administration (FHWA) (2003a), "Geotechnical Engineering Circular No. 7 – Soil Nail Walls", FHWA-IF-03-017, Washington, D.C.
- Federal Highway Administration (FHWA) (2002), Drilled Shaft Foundation Inspection, National Highway Institute (NHI) Course No. 132070, Federal Highway Administration Publication No. FHWA NHI-03-017.
- Federal Highway Administration (FHWA) (2002a) "Geotechnical Engineering Circular No. 5 - Evaluation of Soil and Rock Properties", FHWA-IF-02-034, Washington, D.C.
- Federal Highway Administration (FHWA) (2002b) "Subsurface Investigations – Geotechnical Site Characterization – Reference Manual", FHWA-NHI-01-031, Washington, D.C.



- Federal Highway Administration (FHWA) (1999) "Training Course in Geotechnical and Foundation Engineering: Rock Slopes - Participants Manual" FHWA-HI-99-007, Washington, D.C.
- Federal Highway Administration (FHWA) (1998) "Training Course in Geotechnical and Foundation Engineering: Geotechnical Instrumentation - Participants Manual" FHWA-HI-98-034, Washington, D.C.
- Federal Highway Administration (FHWA) (1999), Drilled Shafts: Construction Procedures and Design Methods, by O'Neil, M. W. and Reese, L. C., for Federal Highway Administration, FHWA Report No. FHWA-IF-99-025.
- Federal Highway Administration (FHWA) (1996). "Geotechnical Differing Site Conditions." Geotechnical Engineering Notebook Issuance GT-15, Washington D.C., 37 p.
- Federal Highway Administration (FHWA) (1989). "Rock Slopes: Design, Excavation, Stabilization," Circular No. FHWA: TS-89-045, Washington, D.C.
- Federal Highway Administration (FHWA) (1988) "Checklist and Guidelines for Review of Geotechnical Reports and Preliminary Plans and Specifications", FHWA-ED-88-053, Washington, D.C.
- Federation of Piling Specialists (1975). "Specifications for Cast-in-Place Piles Formed under Bentonite Suspension," Ground Engineering, Vol. 8, No. 2, London, March.
- Fellenius, B.H. (2006), "Results from Long-Term Measurement in Piles of Drag Load and Downdrag," Canadian Geotechnical Journal, Vol. 43, No. 4, pp. 409-430.
- Ferguson, P.M. (1988), "Reinforced Concrete Fundamentals", Fourth Edition, John Wiley and Sons, New York.
- Ferguson, P. M. (1981). Reinforced Concrete Fundamentals, Fourth Edition, John Wiley and Sons, Inc., New York.
- Finno, R.J. and Gassman, S.L. (1998). "Impulse Response Evaluation of Drilled Shafts," Journal of Geotechnical and Geoenvironmental Engineering, ASCE, Vol. 124, No. 10, pp. 965-975.
- Fleming, W. K., and Sliwinski, Z. J. (1977). "The Use and Influence of Bentonite in Bored Pile Construction," Report No. PG3, Construction Industry Research and Industry Association, London, September.
- Florida Department of Transportation (2007), Florida Department of Transportation, Standard Specifications for Road and Bridge Construction.
- Florida Department of Transportation (1997). User's Manual for Florida-Pier Program, Version 7.0, Florida Department of Transportation, Tallahassee, Florida.
- Focht, J. A., Jr., and Koch, K. J. (1973). "Rational Analysis of the Lateral Performance of Offshore Pile Groups," Proceedings, Fifth Offshore Technology Conference, Vol. 2, Dallas, Texas, pp. 701 - 708.
- Folliard, K.J., Barborak, R., Drimalas, T., Du, L., Garber, S., Ideker, J., Ley, T., Williams, S. (2006), "Preventing ASR/DEF in New Concrete," Final Report FHWA/TX-06/0-4085-5, Center for Transportation Research, Austin, Texas, 233 pp.

- Folliard, K.J., Juenger, M.G., Schindler, A.K., Riding, K.A., Poole, J.L., Satmick, S., Whigham, J.A., Meadows, J.L. (2008). "Prediction model for concrete behavior". TxDOT Research Report No. 4563-1, Concrete Durability Center, The University of Texas at Austin, Texas, 65 pages.
- Fredlund, D.G. (1997). "An Introduction to Unsaturated Soil Mechanics," Geotechnical Special Publication No. 68, Unsaturated Soil Engineering Practice, S.L. Houston and D.G. Fredlund, Editors, ASCE, New York, NY, pp. 1-37.
- Fredlund, D.G, and Rahardjo, H. (1993), "Soil Mechanics for Unsaturated Soils", John Wiley & Sons, New York, 560 p.
- Frizzi, R.P., Meyer, M.E., and Zhou, L. (2004). "Full Scale Field Performance of Drilled Shafts Constructed Utilizing Bentonite and Polymer Slurries," Geo-Support 2004, Geotechnical Special Publication No. 124, J.P. Turner and P.W. Mayne, eds., ASCE, Reston, VA, pp. 573-586.
- Fuller, F. M., and Hoy, H. E. (1970). "Pile Load Tests Including Quick Load Test Method, Conventional Methods and Interpretations," Highway Research Record 333, Highway Research Board, Washington, DC, pp. 74-86.
- Gabr, M.A., Borden, R.H., Cho, K.H., Clark, S., and Nixon, J.B. (2002), "P-y Curves for Laterally Loaded Drilled Shafts Embedded in Weathered Rock," Report No. FHWA/NC/2002/08, North Carolina State University, Raleigh, NC, 289 p.
- Garg, K.G. (1979), "Bored Pile Groups under Vertical Load in Sand," Journal of the Geotechnical Engineering Division, ASCE, Vol. 105, No. GT8, pp. 939-956.
- Gassman, S.L. and Li, H. (2009). "Impedence Logs for Drilled Shafts at the Northwestern NGES," Geotechnical Special Publication No. 185, Contemporary Topics in Deep Foundations, Selected Papers from the 2009 International Foundation Congress and Equipment Expo, Ed. by M. Iskander, D.F. Laefer, and M.H. Hussein, ASCE, Reston, VA, pp..
- Gazetas, G., Fan, K., Tazoh, T., Shimuzu, K., Kavvadas, M., and Makris, N. (1992), "Seismic Pile-Group-Structure Interaction," Geotechnical Special Publication No. 34, Piles Under Dynamic Loads, S. Prakash, Editor, ASCE, New York, NY, pp. 56-93.
- Gerwick, B.C. (2004). "Pile Installation in Difficult Soils," J. Geotech. and Geoenviron. Engrg, Vol. 130, Issue 5, pp. 454-460.
- Gerwick, B.C. (1987). Personal Communication.
- Gerwick, B.C. (1965). "Bell-Pier Construction, Recent Developments and Trends," Journal of the American Concrete Institute, Vol. 62, October, pp. 128 - 129.
- Ghosn, M, Moses, F., and Wang, J. (2003). "Design of Highway Bridges for Extreme Events," NCHRP Report 489, National Cooperative Highway Research Program, Transportation Research Board, Washington, D.C., 174 p.
- Gray, G. R., Darley, H. C. H., and Rogers, W. F. (1980), "Composition and Properties of Oil Well Drilling Fluid", Fourth Edition, Gulf Publishing Company, Houston.

- Greer, D.M. and Gardner, W.S. (1986), "Construction of Drilled Pier Foundations". John Wiley & Sons, New York, 246p.
- Gromko, G.J. (1974). "Review of Expansive Soils," Journal of the Geotechnical Engineering Division, ASCE, Vol. 100, No. GT6, June, pp. 667 - 687.
- Hadjian, A.H., Fallgren, R.B., and Tufenkjian, M.R. (1992). "Dynamic Soil-Pile-Structure Interaction – The State of Practice," Geotechnical Special Publication No. 34, Piles Under Dynamic Loads, S. Prakash, Editor, ASCE, New York, NY, pp. 1-26.
- Hannigan, P. J., G.G. Goble, G.E. Likins, and F. Rausche, (2006), "Design and Construction of Driven Pile Foundations – Volume I", FHWA-NHI-05-042, National Highway Institute Federal Highway Administration U.S. Department of Transportation Washington, D.C.
- Hassan, K.M, and M.W. O'Neill, (1997). "Side Load-Transfer Mechanisms in Drilled Shafts in Soft Argillaceous Rock, Journal of Geotechnical and Geoenvironmental Engineering, Vol. 123, No. 2, ASCE, pp. 145-152.
- Hassan, K.M, O'Neill, M.W., Sheikh, S.A., and Ealy, C.D. (1997). "Design Method for Drilled Shafts in Soft Argillaceous Rock, Journal of Geotechnical and Geoenvironmental Engineering, Vol. 123, No. 3, ASCE, pp. 272-280.
- Hassan, K. H., O'Neill, M. W., and Sheikh, S. A. (1993). "Bored Piles in Clay-Shale Using Expansive Concrete," in Proceedings, Second International Geotechnical Seminar on Deep Foundations on Bored and Auger Piles, W. F. Van Impe, Ed., Balkema, Rotterdam, pp. 289 - 294.
- Hatanaka, M., and Uchida, A. (1996). "Empirical Correlation Between Penetration Resistance and Internal Friction Angle of Sandy Soils," Soils and Foundations, Vol. 36, No. 4, pp. 1-9.
- Hertlein, B.H. (2009). Geotechnical Special Publication No. 185, Contemporary Topics in Deep Foundations, Selected Papers from the 2009 International Foundation Congress and Equipment Expo, Ed. by M. Iskander, D.F. Laefer, and M.H. Hussein, ASCE, Reston, VA, pp..
- Hertlein, B.H., and Baker, C.N., Jr. (1996). "Practical Experience with Non-Destructive Testing of Deep Foundations: A Drilled Shaft Inspector's Guide to Detecting Anomalies and Assessing the Significance of 'Defects,'" Foundation Drilling, ADSC, Dallas, TX, March/April 1996, pp. 19-26.
- Hertlein, B.H., and Davis A.G. (2006). Nondestructive Testing of Deep Foundations, John Wiley and Sons, New York, 290 p.
- Hibbett, Karlsson and Sorensen, Inc. (1996). ABAQUS Theory Manual, HKS, Pawtucket, RI.
- Hiltunen, D.R., and Roth, M.J.S. (2004). "Investigation of Bridge Foundation Sites in Karst Terrane Via Multi-Electrode Resistivity," Proceedings, Geotechnical and Geophysical Site Characterization, A.V. da Fonseca and P.W. Mayne, Editors, Millpress Science Publishers, Rotterdam, pp. 483-490.
- Hodgeson, P. T. (1979). "Design and Control of Bentonite Clay Suspensions and Concrete Diaphragm Wall Construction," Review of Diaphragm Walls.

- Hodgson, D.N., Schindler, A.K., Brown, D.A., and Stroup-Gardiner, M. (2005). "Self-consolidating concrete (SCC) for use in drilled shaft applications", *ASCE Journal of Materials in Civil Engineering*, Vol. 17, No. 3, pp. 363-369.
- Hoek, E. and Marinos, P. (2007). "A Brief History of the Development of the Hoek-Brown Failure Criterion," *Brazilian Journal of Soils and Rock*, Vol. 2, pp. 1-11.
- Hoek, E., Carranza-Torres, C., and Corkum, B. (2002). "Hoek-Brown Failure Criterion – 2002 Edition," *Proc. North American Rock Mechanics Society Meeting*, Toronto.
- Hoek, E., and Brown, E.T. (1997). "Practical Estimates of Rock Mass Strength," *International Journal of Rock Mechanics and Mineral Science*, Vol. 34, No. 8, pp. 1165-118.
- Hoek, E. and Brown, E.T. (1988). "The Hoek–Brown Failure Criterion—A 1988 Update," in *Rock Engineering for Underground Excavations, Proceedings 15th Canadian Rock Mechanics Symposium*, Toronto, ON, Canada, pp. 31–38.
- Hoek, E., Kaiser, P.K., and Bawden, W.F. (1995). "Support of Underground Excavations in Hard Rock", A.A. Balkema, Rotterdam, 215 p.
- Hoek, E., and Brown, E.T. (1980). "Empirical Strength Criterion for Rock Masses," *Journal of Geotechnical Engineering*, Vol. 106, No. GT9, ASCE, pp. 1013-1035.
- Hoffmann, D.L. (1966). "Pioneer Caisson Building Foundations: 1890" *Journal of the Society of Architectural Historians*, Vol. 25, No. 1, March, pp. 68-71.
- Hoit, M., Hays, C., and McVay, M. (1997). "The Florida Pier Analysis Program: Methods and Models for Pier Analysis and Design," *Transportation Research Record No. 1569*, Transportation Research Board, Washington, D. C., pp. 1 - 7.
- Holden, J. C. (1984). "Construction of Bored Piles in Weathered Rock, Part 4: Bentonite Construction Procedures," *Technical Report No. 6*, Road Construction Authority of Victoria, Australia.
- Hollema, D.A. and Olson, L.D. (2002). "Cross Hole Sonic Logging and Tomography Velocity Imaging of a New Drilled Shaft Bridge Foundation," Paper presented at the *Structural Materials Technology V Conference*, American Society for Nondestructive Testing, Inc., Cincinnati, OH, September 10-13, 2002.
- Horvath, R.G., Kenney, T.C., and Kozicki, P. (1983). "Methods of Improvding the Performance of Drilled Piers in Weak Rock," *Canadian Geotechnical Journal*, Vol. 20, pp. 758-772.
- Horvath, R.G. and Kenney, T.C. (1979). "Shaft Resistance of Rock Socketed Drilled Piers," *Proceedings, Symposium on Deep Foundations*, ASCE, New York, pp. 182-214.
- Hutchinson, M. T., Daw, G. P., Shotton, P. G., and James, A. N. (1975). "The Properties of Bentonite Slurries Used in Diaphragm Walling and Their Control," *Diaphragm Walls and Construction*, ICE, London, pp. 33-39.
- International Society for Rock Mechanics (1981). "Basic Geotechnical Description of Rock Masses", *International Journal Rock Mechanics, Mineral Science & Geomechanics Abstracts.*, Vol. 18, No. 1, pp. 85-110.

- Iskander, M., Roy, D., Ealy, C.D., and Kelley, S. (2001). "Class-A Prediction of Construction Defects in Drilled Shafts," *Transportation Research Record 1772*, Paper No. 01-0308, Transportation Research Board, Washington, D.C., pp. 73-83.
- Ismael, N.F. (2001). "Axial Load Tests on Bored Piles and Pile Groups in Cemented Sands," *Journal of Geotechnical and Geoenvironmental Engineering*, Vol. 127, No. 9, pp. 766-773.
- ISRM (1987). "Suggested Methods for Deformability Determination Using a Flexible Dilatometer." *International Journal of Rock Mechanics, Mineral Science, and Geomechanics*, Abstract, Volume 24, Number 2, pp. 123-134.
- Jacobson, F.K. (2007). "Construction of the Main Tower Pier Caissons for the Greenville Bridge in Mississippi," *Proceedings of the Deep Foundation Institute's Specialty Seminar: Marine Foundations, Inland Waterways of the U.S.*, Chicago, May, pp 1-12.
- Johnson, L.D. and Stroman, W.R. (1984). "Vertical Behavior of Two 16-Year-Old Drilled Shafts in Expansive Soil," in *Analysis and Design of Pile Foundations*, J.R. Meyer, Editor, ASCE, October, 1984, pp. 154 - 173.
- Johnston, I.W., T.S.K. Lam, and Williams, A.F. (1987). "Constant Normal Stiffness Direct Shear Testing for Socketed Pile Design in Weak Rock," *Geotechnique*, Vol. 37, No. 1, pp. 83-89.
- Johnston, I. W., Donald, I. B., Bennet, A. G., and Edwards, J. W. (1980). "The Testing of Large Diameter Pile Rock Sockets with a Retrievable Test Rig," in *Proceedings, Third Australia / New Zealand Conference on Geomechanics*, Wellington, Vol. 1, Australian Geomechanics Society, pp. 1-105 - 1-108.
- Jones, W.C. and Wu, Y. (2005). "Experiences with Cross-Hole Sonic Logging and Concrete Coring for Verification of Drilled Shaft Integrity," *Proceedings, GEO3: Geo Construction Quality Assurance/Quality Control*, D.A. Bruce and A.W. Cadden, Editors, ADSC: International Association of Foundation Drilling, Dallas, TX, pp. 376-387.
- Katzenbach, R., Hoffmann, H., O'Neill, M.W., and Turner, J.P. (2008). "Load Transfer and Capacity of Drilled Shafts with Full-Depth Casing," *Proceedings of the 32<sup>nd</sup> Annual Deep Foundations Inst. Annual Conference*, Colorado Springs, 11p.
- Kavazanjian, E., Jr., Matasovic, N., Hadj-Hamou, T., and Sabatini, P.J. (1997). "Design Guidance: Geotechnical Earthquake Engineering for Highways, Volume I - Design Principles," *Geotechnical Engineering Circular No. 3, FHWA-SA-97-076*, Federal Highway Administration, Washington, D.C., 186 p.
- Kavazanjian, E., Jr., Matasovic, N., Hadj-Hamou, T., and Wang, J-N. (1998). "Geotechnical Earthquake Engineering Reference Manual," *Report No. FHWA-HI-99-012*, National Highway Institute, Federal Highway Administration, Arlington, VA, 392 p.
- Kiefer, T. A., and Baker, C. N., Jr. (1994), "The Effects of Free Fall Concrete in Drilled Shafts", ADSC, Dallas, Texas.

- Kim, M.H. and O'Neill, M.W. (1996). "Effect of an Expansive Clay on the Behavior of Drilled Shafts", Report to the National Science Foundation and University of Washington, Department of Civil and Environmental Engineering, University of Houston, December, 1996, 222 pp.
- Kimmerling, R.E. (2002). "Geotechnical Engineering Circular No. 6, Shallow Foundations," Report No. FHWA-IF-02-054, Federal Highway Administration, Washington, D.C., 310 p.
- Kosmatka, S., Kerkhoff, B., and Panarese, W. (2002). "Design and Control of Concrete Mixtures," 14<sup>th</sup> Edition, Portland Cement Association.
- Kranc, S.C., and Mullins, A.G. (2007). "Inverse Method for the Detection of Voids in Drilled-Shaft Concrete Piles from Longitudinal Temperature Scans," Proceedings, Symposium on Inverse Problems, Design and Optimization, Miami, FL, 6 p.
- Krohn, J.P. and Slosson, J.E. (1980). "Assessment of Expansive Soils in the United States," Proceedings, 4<sup>th</sup> International Conference on Expansive Soils, Vol. 1, D. Snethen, Editor, ASCE, New York, NY, pp. 596-608.
- Kulhawy, F.H. and Chen, J.-R. (2007). "Discussion of 'Drilled Shaft Side Resistance in Gravelly Soils' by Kyle M. Rollins, Robert J. Clayton, Rodney C. Mikesell, and Bradford C. Blaise," Journal of Geotechnical and Geoenvironmental Engineering, ASCE, Vol. 133, No. 10, pp. 1325-1328.
- Kulhawy, F.H. and Prakoso, W.A. (2007). "Issues in Evaluating Capacity of Rock Socket Foundations," Proceedings, 16<sup>th</sup> Southeast Asian Geotechnical Conference, Southeast Asian Geotechnical Society, Malaysia.
- Kulhawy, F.H., Prakoso, W.A., and Akbas, S.O. (2005). "Evaluation of Capacity of Rock Foundation Sockets," Alaska Rocks 2005, Proceedings, 40<sup>th</sup> U.S. Symposium on Rock Mechanics, G. Chen, S. Huang, W. Zhou and J. Tinucci, Editors, American Rock Mechanics Association, Anchorage, AK, 8 p. (on CD-ROM).
- Kulhawy, F.H. and Phoon, K-K. (1993). "Drilled Shaft Side Resistance in Clay Soil to Rock," Geotechnical Special Publication No. 38: Design and Performance of Deep Foundations, ASCE, New York, pp. 172-183.
- Kulhawy, F.H. (1991). "Drilled Shaft Foundations." Chapter 14 in Foundation Engineering Handbook, 2<sup>nd</sup> Ed., H.-Y. Fang, Editor, Van Nostrand Reinhold, New York, pp. 537-552.
- Kyfor, Z.G., Schnore, A.R., Carlo, T.A., and Baily, P.F. (1992). "Static Testing of Deep Foundations" Report No. FHWA-SA-91-042, 174p.
- Lagasse, P.F., J.D. Schall, and E.V. Richardson, E.V. (2001a). "Stream Stability at Highway Structures," Hydraulic Engineering Circular No. 20, Third Edition, FHWA NHI 01-002, Federal Highway Administration, Washington, D.C.
- Lam, I.P. and Martin, G.R. (1986). "Seismic Design of Highway Bridge Foundations" Vols. I, II, and III, Report Nos. FHWA/RD-86-101, 102, 103, U.S. Department of Transportation, Federal Highway Administration, McLean, VA.

- Latotzke, J., König, D., and Jesseberger, H. L., 1997. "Effects of Reaction Piles in Axial Pile Tests," in Proceedings of the Fourteenth International Conference on Soil Mechanics and Foundation Engineering, Vol. 2, Balkema, Rotterdam, pp. 1097 - 1101.
- LCPC (1986), Bored Piles, English Translation of Les Piem Fores, Le Laboratoire Central des Ponts et Chaussées, March. (Also published as Report No. FHWA TS-86-206.)
- Liebich, B.A. (2004). "Acceptance Testing of Drilled Shafts by Gamma-Gamma Logging," Geotechnical Special Publication No. 126, Geotechnical Engineering for Transportation Projects, Vol. 2, ASCE, Reston, VA, pp. 1200-1208.
- Likins, G.E., Rausche, F., Webster, K., Klesney, A. (2007). "Defect Analysis for CSL Testing," Geotechnical Special Publication No. 158, Contemporary Issues in Deep Foundations, Proceedings from Geo-Denver 2007 New Peaks in Geotechnics (CD-ROM), ASCE, Reston, VA.
- Liu, J.L., Yuan, Z.L., and Zhang, K.P. (1985). "Cap-pile-soil interaction of bored pile groups," Proceedings, 11<sup>th</sup> International Conference on Soil Mechanics and Foundation Engineering, Vol. 3, Balkema, Rotterdam, The Netherlands, pp. 1433-1436.
- Lizzi, F. (1983). "Ultimate Bearing Capacity of Friction Piles Calculated from Load Tests on Pilot Piles," Ground Engineering, July, 1983.
- Lo, S.-C.R. and K.S. Li (2003). "Influence of a Permanent Liner on the Skin Friction of Large Diameter Bored Piles in Hong Kong Granitic Sapolites, Canadian Geotechnical Journal, NO. 40, pp. 793-805.
- Loehr, J.E and Brown, D.A. (2007). "A Method for Predicting the Mobilization of Resistance for Micropiles Used in Slope Stability Applications" report to the joint ADSC/DFI Micropile Committee
- Louie, J, N. (2001). "Faster, Better: Shear-Wave Velocity to 100 Meters Depth from Refraction Microtremor Arrays," Bulletin of the Seismological Society of America, v. 91, p. 347.
- MacDonald, K.A. (2008). "High Pozzolan High Performance Concrete in Action". Proceedings on the NRMCA Symposium on Focus on Sustainable Development, Denver, Colorado.
- Mackay, S. (1990). "The Forth Bridge: A Picture History". Mercat Press, Edinburgh, 112p.
- Mander J.B., Priestley M. J. N., and Park R. (1988), "Theoretical stress-strain model for confined concrete," J. Struct. Eng. 1988;114(8):1804, 1826.
- Majano, R. E. and O'Neill, M. W. (1993). "Effect of Mineral and Polymer Slurries on Perimeter Load Transfer in Drilled Shafts," Report UHCE 93-1, University of Houston Dept. of Civil and Environmental Engineering to ADSC: The International Association of Foundation Drilling, 375 p.
- Majano, R. E., O'Neill, M. W., and Hassan, K. M. (1994). "Perimeter Load Transfer in Model Drilled Shafts Formed Under Slurry," Journal of Geotechnical Engineering, ASCE, Vol. 120, No. 12, pp. 2136-2154.
- Marinos, P., and Hoek, E. (2000). "GSI: A Geologically Friendly Tool for Rock Mass Strength Estimation," Proceedings, Geo-Engineering 2000, International Conference on Geotechnical and Geological Engineering, Melbourne, Australia, pp. 1422-1440.

- Matlock, H. (1970). "Correlation for Design of Laterally Loaded Piles in Soft Clay," in Proceedings, Second Offshore Technology Conference, Dallas, Texas, pp. 577 - 594.
- Maxim Technologies, Inc. (1996). "Baroid Division of Dresser Industries, Testing Program," Report No. 620272A, Fort Worth, Texas, August.
- Mayne, P.W. (2007). NCHRP Synthesis 368: "Cone Penetration Testing", Transportation Research Board, National Research Council, Washington, D.C., 117 p.
- Mayne, P.W., Christopher, B., Berg, R., and DeJong, J. (2001). "Manual on Subsurface Investigations," Publication No. FHWA NHI-01-031, National Highway Institute, Federal Highway Administration, Washington, D.C., 301 p.
- Mayne, P.W., and Harris, D.E. (1993). "Axial Load-Displacement Behavior of Drilled Shaft Foundations in Piedmont Residuum," FHWA Reference Number 41-30-2175, Georgia Tech Research Corporation, Atlanta, GA.
- Mayne, P.W. and Kulhawy, F.H. (1982). "K0-OCR Relationships in Soil". Journal of Geotechnical Engineering, Vol. 108 (GT6), pp. 851-872.
- McClelland, M. (2008). Personal Communication to J. Turner, June 15, 2008.
- McCullough, D.G. (1972), "The Great Bridge". Simon and Schuster, New York, 636p.
- McGillivray, R. and Brown, D. (2007). "The Tampa Cross Town Expressway Reversible Lane Bridge, the Failure, the Remedial Actions and the Lessons Learned," presentation to ASCE Florida Section Annual Meeting, Ponte Vedra, FL, Aug.
- McManus, K.J. and Turner, J.P. (1996). "Axial Capacity of Bored Pile Foundations During Earthquake Loading," IPENZ Transactions, The Institution of Professional Engineers New Zealand, Vol. 23, No. 1/CE, pp. 26-32.
- McVay, M., Huang, S., and Casper, R. (1994). *Numerical Simulation of Drilled Shafts for Osterberg, Pullout, and Axial Compression Loading in Florida Limestone*. Final Report. Department of Civil Engineering, University of Florida, Gainesville, Florida.
- McVay, M., Kuo, C.L. and Guisinger, A.L. (2003). "Calibrating Resistance Factors for Load and Resistance Factor Design for Statnamic Load Testing." Univ. of Florida Report to FDOT, March, 129p.
- McVay, M.C, Townsend, F.C., and Williams, R.C. (1992). "Design of Socketed Drilled Shafts in Limestone," *Journal of Geotechnical Engineering*, ASCE, Vol. 118, No. 10, pp. 1226-1237.
- Meyers, B. (1996). "A Comparison of Two Shafts: Between Polymer and Bentonite Slurry Construction and Between Conventional and Osterberg Cell Load Testing," Paper Presented at the Southwest Regional FHWA Geotechnical Conference, Little Rock, Arkansas, April.
- Meyerhof, G. G. (1976). "Bearing Capacity and Settlement of Pile Foundations," Journal of the Geotechnical Engineering Division, ASCE, Vol. 102, No. GT3, March, pp. 197 - 228.



- Merzbacher, C. I., Kersey, A. D., and Friebele, E. J. (1996). "Fiber Optic Sensors in Concrete Structures: A Review," *Smart Materials and Structures*, Vol. 5, IOP Publishing Company, pp. 196-208.
- Middendorp, P. and Verbeek, G.E.H. (2005). "30 Years Experience with the Wave Equation Solution Based on the Method of Characteristics," *Proceedings, GEO3: Geo Construction Quality Assurance/Quality Control*, D.A. Bruce and A.W. Cadden, Editors, ADSC: International Association of Foundation Drilling, Dallas, TX, pp. 364-375.
- Miller, A. D. (2003). "Prediction of Ultimate Side Shear for Drilled Shafts in Missouri Shale". Master of Science Thesis, University of Missouri-Columbia, Columbia, MO
- Molnit, T. and Lee, J.S. (1998), "Comparison Report, Osterberg Cell Test Method (PTP14) versus Kentledge Test Method (PTP15)", MRT C701, Singapore, prepared for Hyundai, 18p.
- Montgomery, C.J., Gerard, R., and Lipsett, A.W. (1980). "Dynamic Response of Bridge Piers to Ice Forces," *Canadian Journal of Civil Engineering*, NRC Research Press, Ottawa, Canada, Vol. 2, No. 2, pp. 345-356.
- Moulton, L.K., GangaRao, H.V.S., and Halvorsen, G.T. (1985). "Tolerable Movement Criteria for Highway Bridges." Report No. FHWA/RD-85/107, Federal Highway Administration, McLean, VA, 118 p.
- Mullins, A.G. (2008). "Thermal Integrity Evaluation of Drilled Shafts," GMEC Conference, Orlando, FL.
- Mullins, G. (2006). Personal communication with D.A. Brown.
- Mullins, G., Winter, D., and Dapp, S. (2006). "Predicting End Bearing Capacity of Post-Grouted Drilled Shaft in Cohesionless Soils," *Journal of Geotechnical and Geoenvironmental Engineering*, Vol. 132, No. 4, pp. 478-487.
- Mullins, G. (2002). "Innovative Load Testing Systems Sub-group Statnamic Testing Critical Evaluation of Statnamic Test Data." Univ. of South Florida Report submitted to NCHRP as part of Project 21-08.
- Mullins, G., Lewis, C.L. and Justason, M.D. (2002). "Advancements in Statnamic Data Regression Techniques," *GSP 116: Deep Foundations 2002*, ASCE, pp. 915-930.
- Munfakh, F. et al. (2001). *Training Course in Geotechnical and Foundation Engineering: Shallow Foundations - Participants Manual FHWA-NHI-01-023*
- Murchison, J. M., and O'Neill, M. W. (1984). "Evaluation of p-y Relationships in Cohesionless Soils," in *Analysis and Design of Pile Foundations*, Ed. by J. R. Meyer, ASCE, pp. 174 - 191.
- Murphy, W. L. (1985). "Geotechnical Descriptions of Rock and Rock Masses," Technical Report GL-85-3, U.S. Army Engineer Waterways Experiment Station, Vicksburg, MS.
- NAVFAC DM-7.1, (1982), "Soil Mechanics, Design Manual 7.1", Department of the Navy, Naval Facilities Engineering Command, Alexandria, VA, 364 p.
- Nash, K. L. (1974). "Stability of Trenches Filled with Fluids, *Journal of the Construction Engineering Division, American Society of Civil Engineers*, Vol. 100, No. C04, December, pp. 533 - 542.

- Ng, C.W. and Lei, G.H. (2003). "Performance of Long Rectangular Barrettes in Granitic Sapolites," *J. Geotech. and Geoenviron. Engrg*, Vol. 129, Issue 8, pp. 685-696.
- Norris, G.M. (1994). "Seismic Bridge Pile Foundation Behavior," Proceedings, International Conference on Design and Construction of Deep Foundations, U.S. Federal Highway Administration, Orlando, FL, Vol. 1, pp. 27-136.
- Norris, G.M. (1995). "Pile Foundation Stiffness as a Function of Free-Field or Near-Field Soil Strain," Geotechnical Special Publication No. 51, Performance of Deep Foundations Under Seismic Loading, J.P. Turner, Editor, ASCE, New York, NY, pp. 32-44.
- Pells, P. J. N., Douglas, D. J., Rodway, B., Thorne, C., and McMahon, B. K. (1978). "Design Loadings for Foundations in Shale and Sandstone in the Sydney Region," *Australian Geomechanics Journal*, Vol. 2, pp. 31-38.
- Pinto, P., McVay, M., Hoit, M., and Lai, P. (1997). "Centrifuge Testing of Plumb and Battered Pile Groups in Sand," *Transportation Research Record No. 1569*, Transportation Research Board, Washington, D. C., pp. 8 - 16.
- Olson, L.D. (2005). "Crosshole Sonic Logging and Tomography for Finding and Imaging Anomalies – Defect Resolution Through Knowledge," Proceedings, GEO3: Geo Construction Quality Assurance/Quality Control, D.A. Bruce and A.W. Cadden, Editors, ADSC: International Association of Foundation Drilling, Dallas, TX, pp. 353-363.
- Olson, L. D., Jalinoos, F., and Aouad, M.F. (1995). "Determination of Unknown Subsurface Bridge Foundations," Final Report, Project No. 21-5, National Cooperative Highway Research Program, Transportation Research Board, Washington, DC, August.
- O'Neill, M.W., and Reese, L.C. (1999). "Drilled Shafts: Construction Procedures and Design Methods," Publication No. FHWA-IF-99-025, Federal Highway Administration, Washington, D.C., 758 p.
- O'Neill, M. W. and Reese, L. C. (1972). "Behavior of Bored Piles in Beaumont Clay," *Journal of Soil Mechanics and Foundation Division, ASCE*, 98(2), pp. 195-213.
- O'Neill, M. J., and Person, G. J. (1998). "Innovative Method for Evaluating Drilled Shaft Foundations for St. Croix River Bridge," paper presented at the Annual Meeting of the Transportation Research Board, Washington, DC.
- O'Neill, M. W., Brown, D. A., Townsend, F. C., and Abar, N. (1997). "Innovative Load Testing of Deep Foundations," *Transportation Research Record 1569*, Transportation Research Board, Washington, DC, pp. 17 - 25.
- O'Neill, M.W., F.C. Townsend, K.H. Hassan, A. Buller, and Chan, P.S. (1996). "Load Transfer for Drilled Shafts in Intermediate Geomaterials," Publication No. FHWA-RD-95-171, Federal Highway Administration, McClean, VA, 1996, 184 p.
- O'Neill, M. W., and Hassan, K. H. (1994). "Drilled Shafts: Effects of Construction on Performance and Design Criteria," in Proceedings, International Conference on Design and Construction of Deep Foundations, U. S. Federal Highway Administration, Vol. 1, pp. 137-187.
- O'Neill, M. W. (1991). "Construction Practices and Defects in Drilled Shafts," *Transportation Research Record 1331*, Transportation Research Board, Washington, DC, pp. 6 - 14.

- O'Neill, M. W., and Hawkins, R. A. (1982). "Pile-Head Behavior of Rigidly Capped Pile Group," Transportation Research Record 884, Transportation Research Board, Washington, DC, pp. 1 - 7.
- O'Neill, M.W. and Poormoayed, N. (1980). "Methodology for Foundations on Expansive Clays," Journal of the Geotechnical Engineering Division, ASCE, Vol. 106, No. GT12, December, 1980, pp. 1345-1367.
- O'Neill, M. W., and Reese, L. C. (1970). "Behavior of Axially Loaded Drilled Shafts in Beaumont Clay," Report No. 89-8, Center for Highway Research, The University of Texas at Austin, December.
- Osgerby, C., and Taylor, P. T. (1968). "Vibrating-wire Load Cell for Long-Term Pile Tests," Experimental Mechanics, Vol. 8, No. 9, September, pp. 429-430.
- Osterberg, J., and Hayes, J. (1999). "Clean Bottoms" presentation made at the ADSC Summer Meeting, Vail, Colorado.
- Osterberg, J. O. (1994). "Recent Advances in Load Testing Driven Piles and Drilled Shafts Using the Osterberg Load Cell Method", Geotechnical Division, Illinois Section, ASCE, 79 pp.
- Osterberg, J. O. (1992). "The Osterberg Load Cell for Testing Drilled Shafts and Driven Piles," report to the Federal Highway Administration, Washington, DC.
- Owens, M. J., and Reese, L. C. (1982). "The Influence of a Steel Casing on the Axial Capacity of a Drilled Shaft," Research Report 255-IF, Report to the Texas State Department of Highways and Public Transportation Center for Transportation Research, Bureau of Engineering Research, The University of Texas at Austin, Austin, TX, July, 204 pp.
- Paikowsky, S.G. (2004), with contributions from Birgisson, B., McVay, M., Nguyen, T., Kuo, C., Baecher, G., Ayyub, B., Stenersen, K., O'Malley, K., Chernauskas, L., and O'Neill, M., "Load and Resistance Factor Design (LRFD) for Deep Foundations," NCHRP Report 507, Transportation Research Board, Washington, DC, 126 pp.
- PCA (2002). "Design and Control of Concrete Mixtures", Fourteenth Edition, Portland Cement Association, Skokie, Illinois, 372 pp.
- Peck, R.B., Hanson, W.E., and Thornburn, T.H. (1974). "Foundation Engineering", Second Edition, John Wiley and Sons, New York, 514 p.
- Prakoso, W.A. and Kulhawy, F.H. (2002). "Uncertainty in Capacity Models for Foundations in Rock," Proceedings, 5th North American Rock Mechanics Symposium, Ed. R. Hammah et al. Toronto, pp. 1241-1248.
- Raba, C. (1977). "Informal lecture on foundations for expansive soils", Texas Section, American Society of Civil Engineers, Austin, Texas, October.
- Rackwitz, R., and Fiessler, B. (1978). "Structural Reliability Under Combined Random Load Sequences," Computers and Structures, Vol. 9, pp. 489-494.
- Randolph, M.F. and C.P. Wroth, C.P. (1978). "Analysis and Deformation of Vertically Loaded Piles," Journal of the Geotechnical Engineering Division, ASCE, Vol. 104, No. GT12, pp. 1465-1488.

- Rasband, A. (2008). Personal communication to J. Turner, September 27, 2008.
- Rausche, F., Ren-Kung, S., and Likins, G.E., Jr. (1991). "Comparison of Pulse Echo and Transient Response Pile Integrity Test Methods," *Transportation Research Record 1331*, Transportation Research Board, Washington, D.C., pp. 21-27.
- Reese, L. C. (1997). "Analysis of Laterally-Loaded Piles in Weak Rock," *Journal of Geotechnical and Geoenvironmental Engineering*, ASCE, Vol. 123, No. 11, November.
- Reese, L. C., Cox, W. R., and Koop, F. D. (1975). "Field Testing and Analysis of Laterally Loaded Piles in Stiff Clay," in *Proceedings, Seventh Offshore Technology Conference*, Vol. 2, Dallas, Texas, pp. 672-690.
- Reese, L. C., and Farmer, G. (1977). "Drilled Shafts for Waterfront Structures," in *Proceedings, Ports '77 Conference*, Long Beach, CA, American Society of Civil Engineers, March.
- Reese, L.C., Isenhower, W.M., and Wang, S-T. (2006). "Analysis and Design of Shallow and Deep Foundations", John Wiley & Sons, Inc., Hoboken, N.J., 574 p.
- Reese, L. C., Isenhower, W. M., and Wang, S-T (1998). "Development in the Analysis of Horizontal Capacity of Bored Piles," in *Proceedings, Third International Geotechnical Seminar on Deep Foundations on Bored and Auger Piles*, Ed. By W, F. Van Impe, Balkema, Rotterdam, pp. 23 - 24.
- Reese, L.C. and O'Neill, M.W. (1989). "New Design Method for Drilled Shafts from Common Soil and Rock Tests," *Foundation Engineering: Current Principles and Practices*, Vol. 2, F.H. Kulhawy, Editor, ASCE, New York, pp. 1026-1039.
- Reese, L.C. and Wang, S.T. (1997). "Technical Manual of Documentation of Computer Program LPILE Plus 3.0 for Windows," Ensoft, Inc., 364p.
- Reese, L. C., Wright, S. G., Wang, S. T., Walsh, M. A., and Mims, J. O., Herbig, R. R., and Franke, R. M. (1987). "Analysis of Drilled Shafts in a Deep Fill," Unpublished Report, Department of Civil Engineering, The University of Texas at Austin, Austin, Texas.
- Richardson, E.V. and Davis, S.R. (2001). "Evaluating Scour at Bridges," *Hydraulic Engineering Circular No. 18*, Fourth Edition, FHWA NHI 01-001, Federal Highway Administration, Washington, D.C.
- Rixner, J.J., Kraemer, S.R. and Smith, A.D. (1986). "Prefabricated Vertical Drains Volume I, Engineering Guidelines". Report No. FHWA/RD-86/168, U.S. Department of Transportation, Federal Highway Administration, Office of Engineering and Highway Operations Research and Development, McLean, 117 p.
- Reese, L.C., and O'Neill, M.W. (1988). "Drilled Shafts: Construction Procedures and Design Methods," Publication No. FHWA-HI88-042, Federal Highway Administration, McClean, VA, 564 p.
- Robertson, P.K. (1990). "Soil Classification Using the Cone Penetration Test". *Canadian Geotechnical Journal*, Vol. 27 (1), pp. 151-158.
- Robertson, P.K., Davis, M.P., and Campanella, R.G. (1989). "Design of laterally loaded driven piles using the flat dilatometer." *Geotechnical Testing Journal*, Vol. 12, No. 1, pp 30-38.

- Rocscience, Inc. (2007), Computer program RocTest [online]. Available: <http://www.rocscience.com/hoek/Hoek.asp> [June 2007].
- Rogers, J.D. (2006). "Gow, Mohr, Terzaghi, and the Origins of the Standard Penetration Test". Presentation for the Annual Meeting Association of Environmental and Engineering Geologists, Boston, Massachusetts, November 3rd, 2006.
- Rollins, K., Herbst, M., Adsero, M., and Brown, D., (2010). "Jet Grouting and Soil Mixing for Increased Lateral Pile Group Resistance." Geotechnical Special Publication 199, Advances in Analysis, Modeling and Design, ASCE, 10p.
- Rollins, K.M., Gerber, T.M., Land, J.D., and Ashford, S.A. (2005). "Lateral Resistance of a Full-Scale Pile Group in Liquefied Sand," Journal of Geotechnical and Geoenvironmental Engineering, Vol. 131, No. 1, 115-126.
- Rollins, K. M., Weaver, T. J., and Peterson, K. T. (1997). "Statnamic Lateral Load Testing of a Full-Scale Fixed-Head Pile Group," in Proceedings of the National Seismic Conference on Bridges and Highways, Sacramento, California, Federal Highway Administration and California Department of Transportation, July, pp. 267 - 282.
- Rowe, R.K. and Armitage, H.H. (1987). "A Design Method for Drilled Piers in Soft Rock," Canadian Geotechnical Journal, Vol. 24, pp. 126-142.
- Sabatini, P., et al. (2005). Micropile Design and Construction Reference Manual FHWA-NHI-05-039
- Sabatini, P.J., Bachus, R.C., Mayne, P.W., Schneider, J.A., and Zettler, T.E. (2002). "Evaluation of Soil and Rock Properties," Geotechnical Engineering Circular No. 5, Federal Highway Administration, Washington, D.C., 385 p.
- Sacre, A. (1977). "A Study of the Pullout Resistance of Drilled Shafts," unpublished Master's thesis, Department of Civil Engineering, The University of Texas at Austin, August, 165 pp.
- Samtani, N.C., Jalinoos, F., and Poland, D.M. (2005). "Integrity Testing of Drilled Shafts – Existing and New Techniques," Proceedings, GEO3: Geo Construction Quality Assurance/Quality Control, D.A. Bruce and A.W. Cadden, Editors, ADSC: International Association of Foundation Drilling, Dallas, TX, pp. 329-340.
- Samtani, N.C. and Nowatzki, E.A. (2006). "Soils and Foundations: Reference Manual", Vol. 1, Publication No. FHWA-NHI-06-088, National Highway Institute, Federal Highway Administration, Washington, D.C., 462 p.
- Sarhan, H., Tabsh, S., O'Neill, M., Ata, A, and Ealy, C. (2002). "Flexural Behavior of Drilled Shafts with Minor Flaws," ASCE GSP No. 116, pp 1136-1151.
- Sarhan, H. and O'Neill, M. (2002). "Aspects of Structural Design of Drilled Shafts for Flexure," ASCE GSP No. 116, pp 1151-1165.
- Schindler, A.K. (2002). "Concrete Hydration, Temperature Development, and Setting at Early-Ages," Ph.D. Dissertation, The University of Texas at Austin, Texas.

- Schindler A.K., and Folliard K.J. (2005). "Heat of hydration models for cementitious materials," *ACI Materials Journal*, Vol. 102, No. 1, pp. 24-33.
- Schmertmann, J.H. (1975). "Measurement of In-Situ Shear Strength." *Proceedings, ASCE Conference on In-Situ Measurement of Soil Properties*, Vol. 2., Raleigh, N.C., pp. 57-138.
- Schulz, W., Conte, J., and Udd, E. (2001). "Long Gage Fiber Optic Bragg Grating Strain Sensors to Monitor Civil Structures," *Proceedings of SPIE*, Vol. 4330, pp 56-65.
- Seed, H.B. and Idriss, I.M. (1982). "Ground Motions and Soil Liquefaction During Earthquakes," *Monograph No. 5, Earthquake Engineering Research Institute, Berkeley, CA*, 134 p.
- Seed, R.B. and Harder, L.F., Jr. (1990). "SPT-Based Analysis of Cyclic Pore Pressure Generation and Undrained Residual Strength," *H.B. Seed Memorial Symposium, J.M. Duncan, Editor, Tech Publishers Ltd., Vancouver, Canada, Vol. 2*, pp. 351-376.
- Seidel, J.P. and Collingwood, B. (2001). "A New Socket Roughness Factor for Prediction of Rock Socket Shaft Resistance," *Canadian Geotechnical Journal*, Vol. 38, pp. 138-153.
- Senna, R.S., Cintra, J.C., and Rezende, M.E. (1993). "Load Distribution in Bored Pile Groups," *Proceedings of the Second International Geotechnical Seminar on Deep Foundations on Bored and Auger Piles, Ghent, Belgium, Balkema, Rotterdam*, pp. 151-154.
- Sheikh, S.A., and O'Neill, M.W. (1988). "Structural Behavior of 45-Degree Underreamed Footings," *Transportation Research Record No. 11 19, Transportation Research Board, Washington, D. C.*, pp. 83 - 91.
- Sheikh, S. A., and O'Neill, M. W. (1987). "Structural Behavior of 45-Degree Underreamed Footings," *Transportation Research Record 1119, Transportation Research Board, Washington, DC*, pp. 83 - 91.
- Sheikh, S. A., and O'Neill, M. W. (1986), "Long-Term Performance of Expansive Concrete Drilled Shafts," *Canadian Journal of Civil Engineering, NRC, Vol. 13., No. 2, April*, pp. 213 - 217.
- Sheikh, S. A., O'Neill, M. W., and Mehrazarin, M. A. (1985). "Expansive Concrete Drilled Shafts," *Canadian Journal of Civil Engineering, NRC, Vol. 12., No. 2, May*, pp. 382-395.
- Sheikh S.A., Fu, Y., and O'Neill, M. W. (1994). "Expansive Cement Concrete for Drilled Shafts," *American Concrete Institute Materials Journal*, Vol. 91, No. 3, May-June, pp. 237 - 245.
- Shi, L. (2003). "The Effect Of Load Direction On Axial Capacity Of Deep Foundations." Ph.D. dissertation, Auburn University, Auburn, AL.
- Sliwinski, 2. J. (1980). Personal Communication.
- Sirles, P., Shawver, J.B., Pullammanappallil, S., and Batchko, Z. (2009). "Mapping Top-of-Bedrock and Soft-Soil Zones Beneath High-Traffic Areas Using 2D REMI", *Proceedings, Symposium on the Application of Geophysics to Engineering and Environmental Problems (SAGEEP 2009), Environmental and Engineering Geophysical Society, Denver, CO*, (available on CD; online @: [www.eegs.org](http://www.eegs.org)).

- Sirles, P.C. (2006). "NCHRP Synthesis 357: Use of Geophysics for Transportation Projects", Transportation Research Board, National Research Council, Washington, D.C., 108 p.
- Sliwinski, Z.J., and Fleming, W.G.K. (1983). "The Integrity and Performance of Bored Piles," in Piling and Ground Treatment for Foundations, Thomas Telford, London, pp. 153 - 165.
- Sliwinski, Z. J. (1977). "The Effect of the Bentonite Displacement Method of Construction on the Bearing Capacity of Piles and Diaphragm Wall Elements," Unpublished Notes for the Meeting of the Concrete Society, Croyden, UK, October 12.
- Snethen, D.R., Johnson, L.D., and Patrick, D.M. (1977). "An Evaluation of Expedient Methodology for Identification of Potentially Expansive Soils," Report No. FHWA-RD-77-94, Office of Research, Federal Highway Administration, Department of Transportation, Washington, D. C., June.
- Snow, R. (1965). "Telldatales," Foundation Facts, Raymond International, Fall, 1965, pp. 12 - 13.
- Stocker, M. (1983). "The Influence of Post-Grouting on the Load-Bearing Capacity of Bored Piles," in Proceedings, Eighth European Conference on Soil Mechanics in Foundation Engineering, Helsinki, Vol. 1, pp. 167 - 170.
- Structural Stability Research Council (SSRC) Task Group 20 (1979). "A Specification for the Design of Steel Concrete Composite Columns," AISC Engineering Journal, American Institute of Steel Construction, Chicago, IL Vol. 16, 4<sup>th</sup> Quarter, pp. 101 – 115.
- Stroman, W.R. (1986). Personal Communication as reported by O'Neill and Reese (1999).
- Structure Point Concrete Software Solutions (2010). Computer Program spColumn, available online: <http://www.structurepoint.org/index.asp>
- Taylor, H.F.W., Famy, C., Scrivener, K.L., (2001). "Delayed ettringite formation," Cement and Concrete Research, Vol. 31, pp. 683-693.
- Terzaghi, K., Peck, R.B., and Mesri, G. (1996). "Soil Mechanics in Engineering Practice", Second Edition, Wiley and Sons, Inc., New York, 549 p
- Terzaghi, K. and Peck, R.B. (1967). "Soile Mechanics in Engineering Practice". John Wiley and Sons, New York.
- Texas Department of Transportation, (TxDOT) (2008a). Chemical Admixtures for Concrete (DMS – 4640), Texas Department of Transportation, Department Materials Specification 4640, Materials and Tests Division, Austin, Texas.
- Texas Department of Transportation, (TxDOT) (2008b). "Materials Producer List – Chemical Admixtures for Concrete", <ftp://ftp.dot.state.tx.us/pub/txdot-info/cmd/mpl/admixtur.pdf>, Texas Department of Transportation, Austin, Texas, accessed on September 2008.
- Texas Department of Transportation, (TxDOT) (2004). "Standard Specifications for Construction of Highways, Streets and Bridges", Texas Department of Transportation, Austin, Texas.
- Texas Department of Transportation (TxDOT) (2000). Geotechnical Manual, [Online]. Available: <http://manuals.dot.state.tx.us/dynaweb/colbridg/geo> [June 2005].

- Tokimatsu, K. and Seed, H.B. (1987). "Evaluation of Settlements in Sands due to Earthquake Shaking," *Journal of Geotechnical Engineering, ASCE*, Vol. 113, No. 8, pp. 861-879.
- Tomlinson, M.J. (1994). "Pile Design and Construction Practices", Fourth Edition, Taylor & Francis.
- Tomlinson, M.J. (1987). "Pile Design and Construction Practice", Viewpoint Publication, London, 415 p.
- Tomlinson, M. J. (1980). "Foundation Design and Construction", Fourth Edition, Pitman Press, Bath-London, England, United Kingdom, p. 406.
- Turner, J.P. (2006). "NCHRP Synthesis 360: Rock-Socketed Shafts for Highway Structure Foundations", Transportation Research Board, National Research Council, Washington, D.C., 148 p.
- UniSoft, Ltd. (2010). Computer Program "UniPile", available online: <http://www.unisoftltd.com/>
- U.S. Army Corps of Engineers (USACE) (2001). "Geotechnical Investigations," Engineering Manual EM 1110-1-1804, Vicksburg, MS.
- U.S. Geological Survey (2010). "Seismic Design Maps and Tools for Engineers," available online as of April 2010, at: <http://earthquake.usgs.gov/research/hazmaps/design/>
- van Bijsterveld, J. J. (1993). "A New Promising Concept for Bored Piles and Tension Piles," in Proceedings, Second International Geotechnical Seminar on Deep Foundations on Bored and Auger Piles, W. F. Van Impe, Ed., Balkema, Rotterdam, pp. 317 - 322.
- Vesic, A.S. (1971). "Breakout Resistance of Objects Embedded in Ocean Bottom," *Journal of the Soil Mechanics and Foundations Division, ASCE*, Vol. 97, No. SM9, pp. 1183-1205.
- Vesic, A.S. (1977). "NCHRP Synthesis 42: Design of Pile Foundations", Transportation Research Board, National Research Council, Washington, D.C., 1977, 68 p.
- Wang, S. T. and Reese, L.C. (1998). "Design of Pile Foundations in Liquefied Soils." *Geotechnical Earthquake Engineering and Soil Dynamics III*, GSP No. 75. P. Dakoulas and M. Yeagian, eds., Vol. 2, ASCE, Reston, Va., 1331-1343.
- Wang, C., and Salmon, C.G. (1985). *Reinforced Concrete Design*, Fourth Edition, Harper and Row, New York.
- Washington Department of Transportation Substructure Design Manual, (2006)
- Wates, J. A., and Knight, K. (1975). "The Effect of Bentonite on the Skin Friction in Cast-in-Place Piles and Diaphragm Walls," in Proceedings, Sixth Regional Conference for Africa on Soil Mechanics and Foundation Engineering, Durban, South Africa, September, pp. 183-188.
- Welch, R. C., and Reese, L. C. (1972). "Laterally Loaded Behavior of Drilled Shafts," Research Report No. 89-10, Center for Highway Research, The University of Texas at Austin, May.
- Weltman, A. J. (1977). "Integrity Testing of Piles: A Review," Report PG4, Construction Industry Research and Information Association, London, September.



- Wilson, E. (2004). "Static and Dynamic Analysis of Structures", 4<sup>th</sup> Edition, Computers and Structures Inc., Berkeley, CA, 418 p.
- Withiam, J.L., Voytko, E.P., Barker, R.M., Duncan, J.M., Kelly, B.C., Musser, S.C., and Elias, V. (1998). "Load and Resistance Factor Design (LRFD) for Highway Bridge Substructures," Publication No. FHWA HI-98-032, Federal Highway Administration, Washington, DC.
- Wray, W.K. (1997). "Using Soil Suction to Estimate Differential Soil Shrink or Heave," Geotechnical Special Publication No. 68, Unsaturated Soil Engineering Practice, S.L. Houston and D.G. Fredlund, Editors, ASCE, New York, NY, pp. 68-87.
- Wyllie, D.C. (1999). "Foundations on Rock", Second Edition, E&FN Spon, New York, 401 p.
- Wyllie, D.C., and Norrish, N.I. (1996). "Rock Strength Properties and Their Measurement," Chapter 14 in Landslides -- Investigation and Mitigation, Special Report 247, Transportation Research Board, National Academy Press, Washington, D.C., pp. 372-390.
- Yang, K. (2006). "Analysis of Laterally Loaded Drilled Shafts in Rock," Ph.D. Dissertation, University of Akron, Akron, OH, 291 p.
- Yazdanbod, A., Sheikh, S.A., and O'Neill, M.W. (1987). "Uplift of Shallow Underream in Jointed Clay," Proceedings, Foundations for Transmission Line Towers, J.-L. Briaud, Editor, ASCE, Reston, VA, pp. 110-127.
- Zhang, L. and Einstein, H.H. (1998). "End Bearing Capacity of Drilled Shafts in Rock," Journal of Geotechnical and Geoenvironmental Engineering, Vol. 124, No. 7, ASCE, pp. 574-584.
- Zonge Geosciences, Inc. (2009). "Geophysical Investigation Report – 2D Seismic Refraction MicroTremor Survey, Honolulu High-Capacity Transit Corridor Project, East Kapolei to Peral Highlands, Ewa, Oahu, Hawaii," Prepared for Geolabs, Inc.

Archived

This page is intentional left blank.

**APPENDIX A**

**DESIGN EXAMPLE:**

**DRILLED SHAFTS FOUNDATIONS  
FOR REPLACEMENT BRIDGE**

Archived

This page is intentional left blank.

## APPENDIX A

### DESIGN EXAMPLE: DRILLED SHAFTS FOR REPLACEMENT BRIDGE

An example is used to illustrate design of drilled shafts as foundations for a proposed replacement bridge. Conditions are based on an actual project. The owner is a state transportation agency and the site is located in the Atlantic Coastal Plain physiographic province. Design of the drilled shaft foundations is used to illustrate the LRFD design procedures presented in this manual. The following aspects of drilled shaft design and corresponding chapters in this manual are incorporated into the example:

Chapter 3:	Evaluation of soil properties
Chapter 10:	Foundation loads and limit states
Chapter 11:	Overall design process
Chapter 12:	Geotechnical design for lateral loading
Chapter 13:	Geotechnical design for axial loading
Chapter 15:	Design for seismic and scour
Chapter 16:	Structural design

#### **General**

The example follows the roadmap presented in Chapter 11 as a step-by-step process outlined in Figure 11-1, entitled “Drilled Shaft Design and Construction Process”. It is assumed that the general project requirements and constraints have been established and preliminary studies on various bridge and foundation options are completed (Steps 1 through 6). A decision has been made to proceed with further evaluation of drilled shafts (Step 7).

The proposed replacement bridge is a 6-span structure, 1,230 ft in length and 57 ft wide, supported on two abutments and five piers. The superstructure consists of AASHTO Modified Type VI spliced post-tensioned girders. Span lengths range from 175 to 220 ft and the trial design calls for three, 8-ft diameter drilled shafts per pier. Each drilled shaft supports an 8-ft diameter concrete pier column, and each set of three pier columns supports a cast-in-place concrete pier cap. The joint between each drilled shaft and pier column is located at elevation 5.0 ft, which is approximately 2.4 ft above the mean high water level (MHW). In the example, drilled shaft design will focus on Pier No. 2 of the proposed bridge. Group effects are not considered and did not govern the final design. Figure A-1 shows a cross section of the bridge at Pier 2.

#### **Summary of Step 3: Determine Substructure Loads and Load Combinations at Foundation Level**

Factored force effects were determined by structural modeling of the bridge using a commercially available finite element computer program. Initially, drilled shafts were modeled as 8.5-ft diameter equivalent fixed-end columns extending from the joint with the pier column (2.4 ft above MHW) to a point of fixity 15 ft below the mudline (10 ft below scour line for limit states that include scour). The diameter of 8.5 ft accounts for permanent casing, which extends to a depth corresponding to the final scour elevation (-67 ft). Figure A-2 shows an example of the frame geometry for the structural model at Pier 2. An additional node was added to each drilled shaft element at the mudline elevation. Force effects calculated at these mudline nodes were taken as the force effects applied to the tops of the drilled shafts in the geotechnical analysis. Additional nodes were added at several intermediate depths below the mudline for modeling the lateral stiffness of the embedded shafts in subsequent iterations.

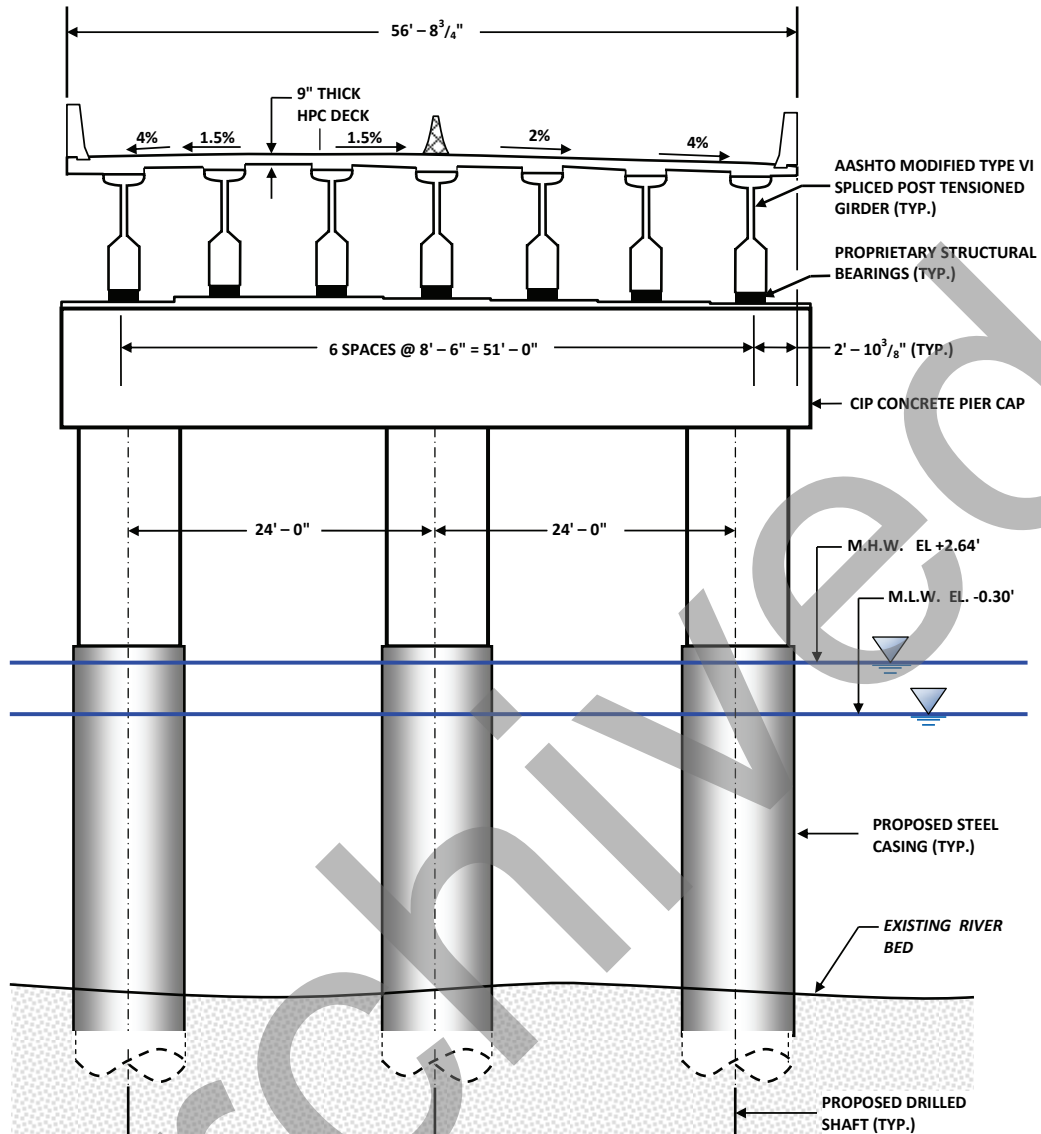


Figure A-1 Pier Section of Proposed Bridge

The iterative procedure for establishing factored force effects on the drilled shafts can be summarized as follows:

1. For each applicable limit state, the structural model is analyzed under the factored loads; load combinations and load factors are those specified in Tables 10-2 and 10-3; drilled shaft lateral spring constants initially are assumed, in consultation with geotechnical specialists.
2. Force effects calculated by the structural modeling program from Step 1 at the mudline nodes are resolved into axial, lateral, and moment components.
3. The factored axial, lateral, and moment force effects from Step 2 are used as the applied loads for analyzing trial drilled shafts by the *p-y* method of analysis using an available computer code; *p-y* curves are established on the basis of soil properties and an idealized subsurface profile; the top of each drilled shaft corresponds to mudline elevation. For the Strength I and Service I Limit

States, mudline corresponds to elevation -67 ft, which accounts for the design scour. For the Extreme Event I Limit State, scour is not included and the mudline elevation is -29 ft.

4. Results of the  $p$ - $y$  analysis are used to evaluate lateral stiffness versus lateral deflection along the length of the drilled shaft; these stiffness profiles are used to develop revised spring constants in subsequent structural modeling.
5. The structural model is re-analyzed using the revised lateral spring constants established in Step 4; drilled shafts are modeled as beam-column elements; these elements are assumed to be pinned at their lower end, at a depth corresponding to zero lateral deflection from the  $p$ - $y$  computer analysis.
6. Steps 3, 4, and 5 are repeated iteratively until lateral deflections at mudline elevation calculated by the structural modeling program and the  $p$ - $y$  analyses show agreement to within  $\pm 10$  percent.

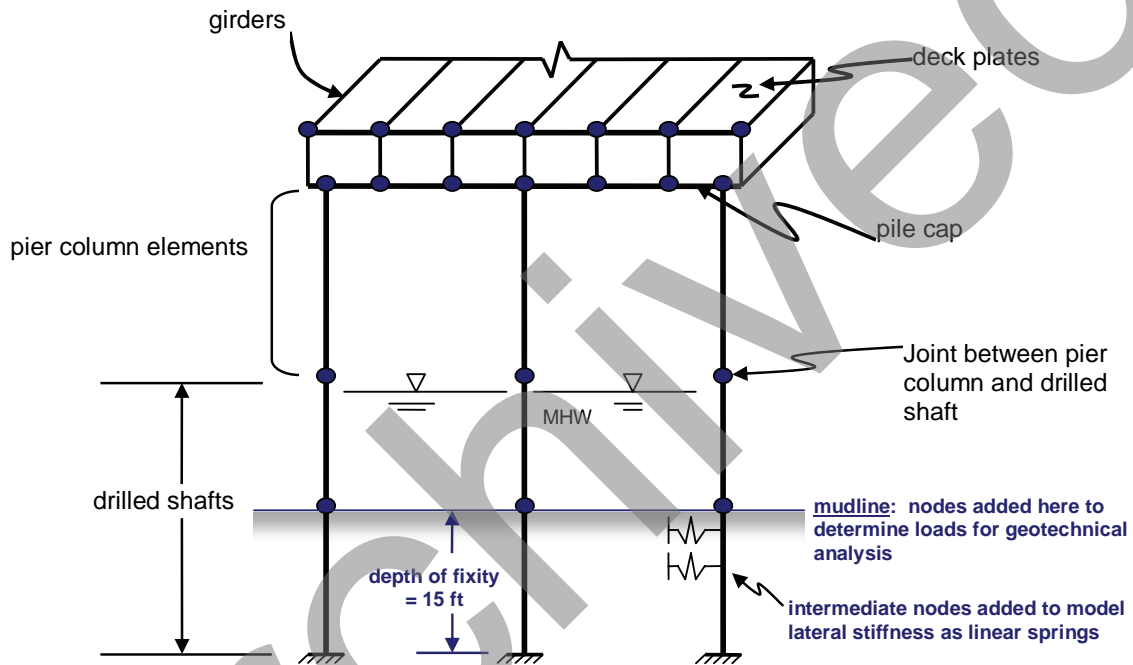


Figure A-2 Idealized Frame Model for Structural Analysis, Pier 2

Factored axial, lateral, and moment force effects resulting from the analysis procedure outlined above are summarized in Table A-1 for the drilled shafts at Pier 2. In subsequent sections, these factored forces are used in limit state checks to show that the drilled shaft design satisfies the basic LRFD requirement, that summation of factored force effects may not exceed the summation of factored resistances.

**TABLE A-1 SUMMARY OF DRILLED SHAFT FACTORED FORCE EFFECTS AT EXISTING MUDLINE, PIER 2**

Limit State	Max Axial Compression (kips)	Min Axial Compression (kips)	Lateral, Longitudinal (kips)	Lateral, Transverse (kips)	Longitudinal Moment (kip-ft)	Transverse Moment (kip-ft)
Strength I	3,390	2,673	37.0	9.6	1,687	222
Service I	2,835	1,836	54.7	34.6	2,647	317
Extreme Event I	2,823	2,810	144.5	290.5	7,776	3,212

## Step 8: Define Subsurface Profile for Analysis

A subsurface exploration program was developed and carried out to gather information necessary for bridge foundations, retaining walls, and embankment design along the proposed alignment and limits. The program consisted of 32 borings. The designers also had access to information from 32 borings made in 1953 for an existing bridge at the project site.

Geologic studies combined with the boring logs show that soils in the project area consist of Pleistocene alluvial deposits overlying Tertiary marine sediments. In some areas of the site the alluvial deposits are covered by recent marsh soils which were deposited in the tidal estuaries along the coastal areas and inland streams of the Atlantic coastal plain. The tidal marsh deposits consist of compressible organic silts and peat extending from approximate mean high water level (elevation + 2.6 ft) to a depth of 10 to 30 ft below mudline (elevations shown in Figure A-3). The underlying Pleistocene alluvial deposits are composed of layers of yellow-brown to gray-white quartz sand and gravel occurring in well defined alternating or intermixed layers. Silts and clay are encountered in lenses or pockets. Tertiary marine deposits underlie the Pleistocene sediments and consist of medium to fine silty sands, white to yellow in color, with localized gray to brown clay layers and lenses.

Figure A-3 shows a generalized subsurface profile along the alignment of the bridge. Soils are subdivided into general strata showing similar properties as described in the Legend of Figure A-3. At Pier No. 2, the reference boring is Boring W-2. Five of the general soil strata are present at Pier 2; these include strata R, C, D, E, and F. Stratum R, river bed material consisting of loose sand and organic soils, is approximately 3.5 ft thick at Pier 2 and is neglected. The uppermost stratum at Pier 2 is therefore Stratum C, which starts at elevation -29 ft. Field N-values from the Standard Penetration Test at Boring W-2 are shown at 5 ft intervals and these values are used to obtain soil engineering properties for drilled shaft design.

### Scour and Seismic Considerations

The profile in Figure A-3 shows the scour line, based on hydrologic studies in accordance with methods presented in Chapter 15 of this manual and described in detail in Hydrologic Engineering Circulars HEC-18 (Richardson and Davis, 2001) and HEC-20 (Lagasse et al., 2001). The scour limit shown is for the design flood (100 year flood) and results in total scour of 38 ft at Pier 2. This total scour is comprised of 18 ft of contraction scour and 20 ft of pier scour. This scour depth results in removal of the upper portion of Stratum C at Pier 2, to an elevation of -67 ft. The resulting subsurface profile (*i.e.*, with full scour) is used to evaluate Strength I and Service I limit states in subsequent design steps. In accordance with the owner specifications, Extreme Event I conditions did not include scour.

The proposed bridge is evaluated for Extreme Event I limit state (earthquake). Although the bridge is determined to be in Seismic Performance Zone 1, the owner-agency designated the bridge as “essential” and required a site-specific response analysis. These analyses were carried out for selected locations along the approach piers and the main span units to account for the variations in subsurface soil conditions along the bridge alignment. The final design ground motions were determined based on the results of all site-specific response analyses, and the following seismic design parameters were established:

Peak Ground Acceleration, 1,000-year event:	$A = 0.052g$
Site Class:	D (stiff soils)
Seismic Importance Category:	Essential
Seismic Performance:	Zone 1
Resulting Elastic Response Coefficient:	$C_{sm} = 0.075$



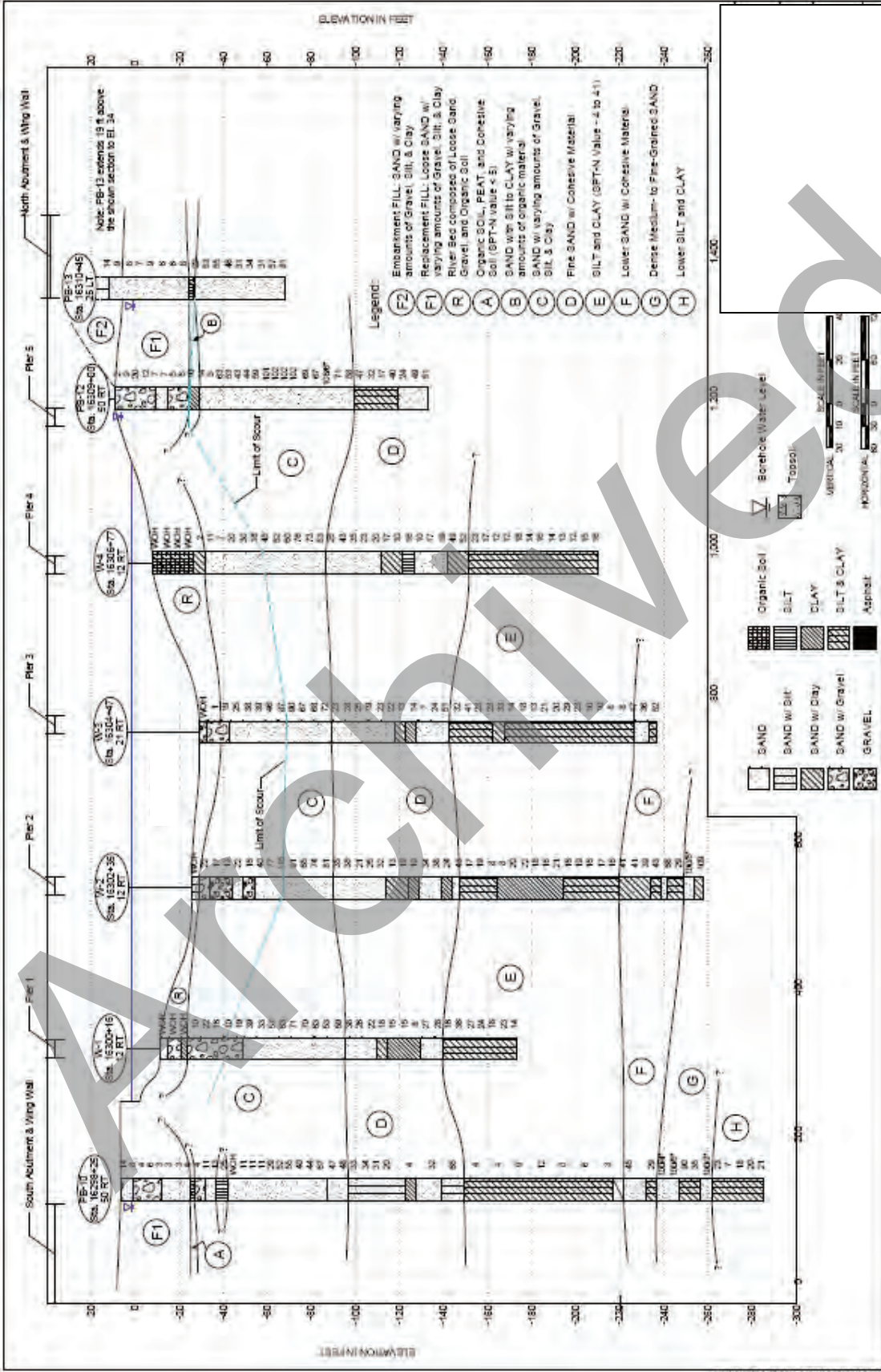


Figure A-3 Generalized Subsurface Profile

The horizontal force effects due to earthquake (EQ) were determined on the basis of the elastic response coefficient ( $C_{sm}$ ) and the equivalent weight of the superstructure, as described in Chapter 15 and in accordance with AASHTO specifications, Updated Seismic Provisions (2007). Structural modeling of the bridge under Extreme Event I loading (including earthquake, EQ) was used to determine the force effects acting on the drilled shaft foundations. The results are presented in Table A-1.

Within the limits of the new bridge piers, liquefaction analysis indicates that the existing fill and underlying sand deposits are generally medium dense to dense and not subject to liquefaction. Although small pockets of loose soils do exist, it was determined that liquefaction of the localized loose material will not adversely affect the drilled shaft foundations.

### Idealized Subsurface Profile at Pier 2

Figure A-4 shows the idealized geomaterial layer profile used for foundation design at Pier 2, based on Boring W-2. Table A-2 presents the depth and elevation limits of each geomaterial, the general stratum to which each layer corresponds, and the geomaterial type. Each geomaterial layer is categorized as either cohesionless soil or cohesive soil. For Strength I and Service I limit state analyses, full scour is assumed, resulting in complete removal of Layer No. 1 and partial removal of Layer No. 2 to a depth of 38 ft (elevation - 67 ft). For Extreme Event I, zero scour is assumed.

**TABLE A-2 SUMMARY OF GEOMATERIAL TYPES AND LAYER THICKNESSES**

Geomaterial Layer No.	Elevation, Top of Layer (ft)	Elevation, Bottom of Layer (ft)	Thickness (ft)	Depth Interval (ft), from Mudline	Subsurface Stratum	Geomaterial Type	
						Cohesionless soil	Cohesive Soil
1	-29	-54	25	0 - 25	C	✓	
2	-54	-94	40	25 - 65	C	✓	
3	-94	-114	20	65 to 85	D	✓	
4	-114	-129	15	85 to 100	D		✓
5	-129	-139	10	100 to 110	D	✓	
6	-139	-219.5	80.5	110 to 190.5	D and E		✓
7	-219.5	-241.5	22	190.5 to 212.5	F	✓	
8	-241.5	-249	7.5	212.5 to 220	F		✓

220

Cohesionless soil layers are analyzed for drained loading response, while cohesive soil layers are analyzed for undrained loading response. The corresponding strength properties required for calculating resistances are: effective stress friction angle ( $\phi$ ) for cohesionless soils and undrained shear strength ( $s_u$ ) for cohesive soils. Table A-3 shows the calculation results for determination of soil friction angle for each of the cohesionless soil layers (Layers 1, 2, 3, 5, and 7). For each layer, the field N-values ( $N_{60}$ ), depth, and vertical effective stress corresponding to each measurement are tabulated. Each field N-value is corrected for effective overburden stress to yield  $(N_1)_{60}$  according to the following equation presented in Chapter 3:

$$(N_1)_{60} = N_{60} \left( \frac{P_a}{\sigma'_{vo}} \right)^n \quad 3-2$$

where  $p_a$  = atmospheric pressure (2,116 psf),  $\sigma'_{vo}$  = vertical effective stress at the depth of the SPT N-value measurement, and  $n = 0.5$  for sandy soils. The mean value of  $(N_1)_{60}$  and corresponding coefficient of variation are then calculated for each layer. The mean value of  $(N_1)_{60}$  is correlated to effective stress friction angle by the following equation, as presented in Chapter 3:

$$\phi' = 27.5 + 9.2 \log[(N_1)_{60}]$$

3-8

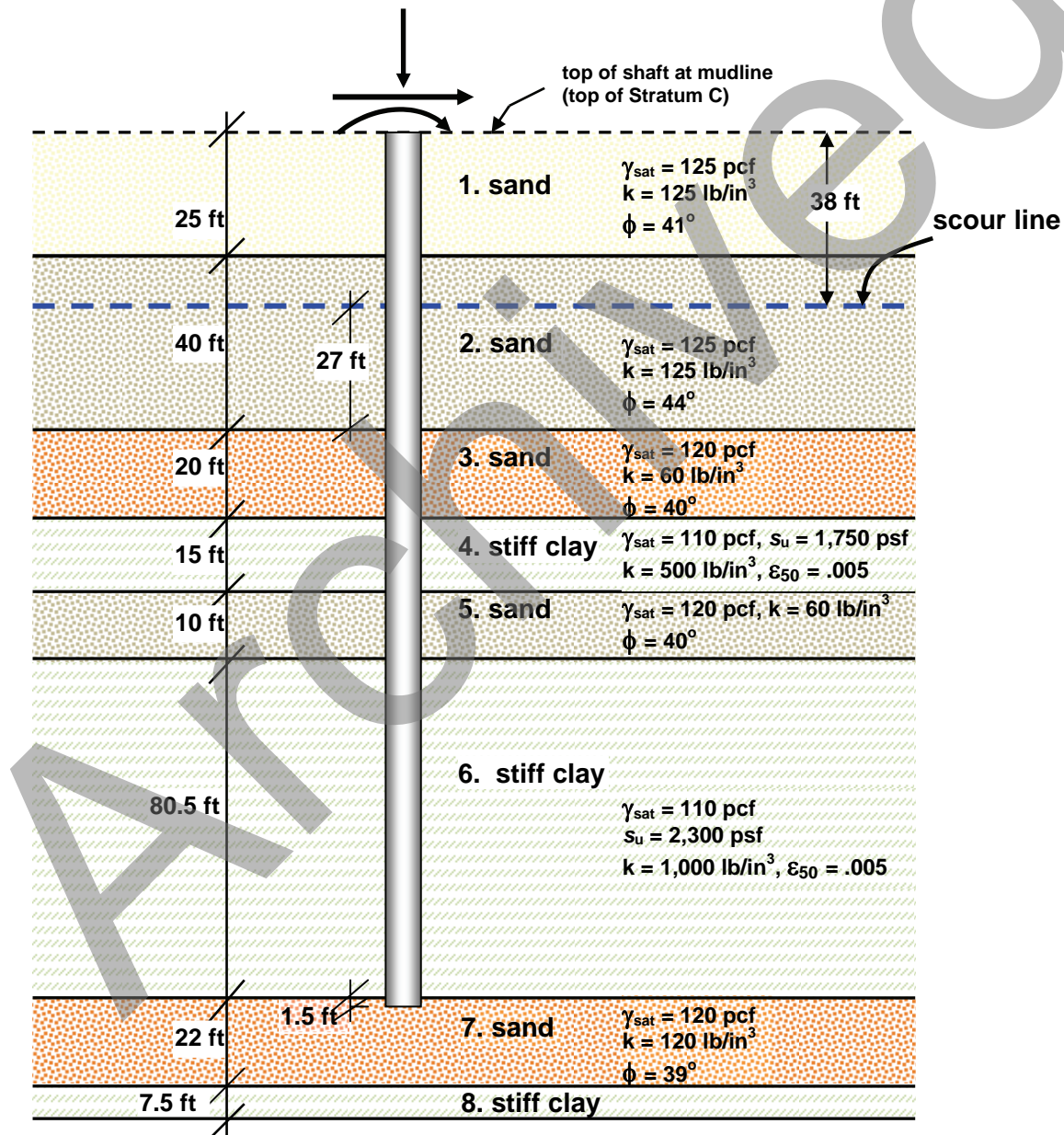


Figure A-4 Idealized Geomaterial Layer Profile for Drilled Shaft Design at Pier 2

**TABLE A-3 FRICTION ANGLE CORRELATIONS FOR COHESIONLESS SOIL LAYERS**

Layer 1:	depth (ft)	$\sigma'_v$ (psf)	Field N-value	Corrected N-value ( $N_1$ ) <sub>60</sub>
	5	313.0	22	44
	10	626.0	17	31
	15	939.0	13	20
	20	1252.0	22	29
	25	1565.0	16	19
			<b>Mean (<math>N_1</math>)<sub>60</sub> =</b>	<b>28</b>
			<b>coefficient of variation =</b>	<b>33%</b>
			<b><math>\phi</math> (degrees) =</b>	<b>41</b>
Layer 2:	depth (ft)	$\sigma'_v$ (psf)	Field N-value	Corrected N-value ( $N_1$ ) <sub>60</sub>
	30	1878.0	40	42
	35	2191.0	77	76
	40	2504.0	100	92
	45	2817.0	91	79
	50	3130.0	65	53
	55	3443.0	74	58
	60	3756.0	81	61
	65	4069.0	35	25
			<b>Mean (<math>N_1</math>)<sub>60</sub> =</b>	<b>61</b>
			<b>coefficient of variation =</b>	<b>33%</b>
			<b><math>\phi</math> (degrees) =</b>	<b>44</b>
Layer 3:	depth (ft)	$\sigma'_v$ (psf)	Field N-value	Corrected N-value ( $N_1$ ) <sub>60</sub>
	65	4069.0	35	25
	70	4357.0	38	26
	75	4645.0	21	14
	80	4933.0	25	16
	85	5221.0	32	20
			<b>Mean (<math>N_1</math>)<sub>60</sub> =</b>	<b>21</b>
			<b>coefficient of variation =</b>	<b>23%</b>
			<b><math>\phi</math> (degrees) =</b>	<b>40</b>
Layer 5:	depth (ft)	$\sigma'_v$ (psf)	Field N-value	Corrected N-value ( $N_1$ ) <sub>60</sub>
	100	5,935	34	20
	105	6,223	38	22
			<b>Mean (<math>N_1</math>)<sub>60</sub> =</b>	<b>21</b>
			<b><math>\phi</math> (degrees) =</b>	<b>40</b>
Layer 7:	depth (ft)	$\sigma'_v$ (psf)	Field N-value	Corrected N-value ( $N_1$ ) <sub>60</sub>
	195	10,602	41	18
	200	10,890	41	18
	205	11,178	39	17
	210	11,466	43	18
			<b>Mean (<math>N_1</math>)<sub>60</sub> =</b>	<b>18</b>
			<b>coefficient of variation =</b>	<b>3%</b>
			<b><math>\phi</math> (degrees) =</b>	<b>39</b>

## Step 9: Define Resistance Factors for Design

Limit states for which the drilled shafts are designed in this example include Strength I, Service I, and Extreme Event I. Resistance factors for each limit state, for geotechnical and structural design, are those presented in Chapter 10 (Table 10-5). Specific values of resistance factors will be presented as part of the calculations carried out for limit state checks applied to design of the shafts for axial loading, lateral loading, and structural design.

## Step 10: Establish Minimum Diameter and Depth for Lateral Loads

As described in Chapter 12, drilled shafts are designed to withstand lateral loading by selecting the dimensions (diameter and depth) and structural properties to satisfy LRFD limit state checks on the geotechnical strength and structural strength for all applicable strength and extreme event limit states. For service limit states, the shaft must develop sufficient resistance at tolerable lateral displacements specified by the structural designer. Figure 12-13 outlines the design process for lateral loading, in which each step is identified as a substep of Block 10 of the overall process.

Substep 10.1 Define the detailed subsurface profiles for each lateral load case, including scour.

The profile shown in Figure A-4 is used to analyze drilled shafts at Pier 2 for lateral loading. Properties required for  $p$ - $y$  curves, including the stiffness factor  $k$  for cohesionless soils and the stiffness parameter  $\epsilon_{50}$  for cohesive soil layers, are shown for each layer. Note that, for Strength I and Service I limit states, full scour of 38 ft is assumed, while for Extreme Event I zero scour is assumed, based on the agency criteria for this project.

Substep 10.2 Select trial length and diameter.

The trial shaft diameter is 8 ft, which is the minimum required to match the diameter of the concrete pier columns. The minimum required length is established on the basis of analysis of the geotechnical strength limit state, as described in the next substep. In addition, analyses will be conducted to check the final design length of 192 ft, which is governed by axial load considerations described in Step 11.

Substep 10.3 Analyze the geotechnical strength limit state using factored force effects.

As described in Section 12.3.3.1, the geotechnical strength under lateral loading is evaluated by conducting a “pushover analysis” in which force effects are applied to the head of the shaft in various multiples up to and exceeding the factored force effects. For each load multiple, lateral head deflection is calculated and the load-deflection curve must exhibit stable behavior up to the maximum load multiples. In addition, lateral deflection at the maximum load must be less than 10% of the shaft diameter. The concrete shaft is modeled in this analysis as a linear elastic beam of modulus equal to that of the concrete and moment of inertia taken as that of the uncracked section. As noted in Chapter 12, the linear elastic model is appropriate in order to prevent the flexural strength of the drilled shaft from being the limiting factor. Also note that maximum bending moment computed by the  $p$ - $y$  analysis is not sensitive to the shaft stiffness.

Modeling of trial shaft lengths by the  $p$ - $y$  method is used to illustrate the analysis of lateral geotechnical strength for Strength I and Extreme Event I limit states. First, the factored force effects presented in Table A-1 for the Strength I limit state are considered. Lateral and moment force effects are given for both longitudinal and transverse directions. The resultant lateral and moment force effects are calculated as follows:

$$V = \sqrt{(V_{longitudinal})^2 + (V_{transverse})^2} = \sqrt{(37.0)^2 + (9.6)^2} = 38.2 \text{ kips}$$

$$M = \sqrt{(M_{longitudinal})^2 + (M_{transverse})^2} = \sqrt{(1,687)^2 + (222)^2} = 1,702 \text{ kip-ft}$$

The minimum axial compressive force given in Table A-1 for Strength I (2,673 kips) is also applied, in combination with the factored shear and moment. Drilled shaft properties used in the *p-y* analysis are summarized in Table A-4.

**TABLE A-4 DRILLED SHAFT PROPERTIES FOR ANALYSES OF GEOTECHNICAL LATERAL STRENGTH**

Diameter:	96 inches	Moment of inertia:	4,169,220 in <sup>4</sup>
Length:	variable	Area:	7,238 in <sup>2</sup>
Distance from shaft top to ground surface:	456 inches	Modulus of elasticity:	4,000,000 lb/in <sup>2</sup>

The soil layers and properties are as shown in Figure A-4, and evaluation of the Strength I limit state incorporates full scour to a depth of 38 ft below the top of the shaft (hence a distance of 456 inches from top of pile to ground surface). The analysis is conducted by applying the shear and moment in increments, up to maximum values of  $1/\phi$  times the factored force effects, where  $\phi$  = resistance factor. For Strength I,  $\phi = 0.67$ , which is equivalent to multiplying the factored force effects by 1.5. For this analysis, the lateral load and moment were applied in multiples of 0.25 up to 1.5 times the factored values. The actual load combinations for each increment are summarized in Table A-5.

**TABLE A-5 LOADING INCREMENTS FOR PUSHOVER ANALYSIS OF TRIAL SHAFT, STRENGTH I**

Load Case	Multiple of Factored Force Effects	Shear Force, V (lbs)	Moment, M (in-lbs)	Axial Force, Q (lbs)
1	0.25	9,553	5,104,121	1,836,420
2	0.50	19,107	10,208,242	1,836,420
3	0.75	28,660	15,312,363	1,836,420
4	1.00	38,213	20,416,484	1,836,420
5	1.25	47,767	25,520,605	1,836,420
6	1.50	57,320	30,624,726	1,836,420

First, the analysis is used to establish the minimum shaft depth required. After several trial analyses, it is found that a shaft length of 62 ft is the minimum required for lateral geotechnical stability. Figure A-5 shows the computed lateral head deflection versus load increment, for three shaft lengths. For a shaft length of 68 ft (corresponding to 30 ft of embedment below the scour line), the load-deflection behavior is approximately linear and stable up to 1.5 times the factored force effects. However, for a shaft length of 62 ft (24 ft of embedment), the load deflection curve shows a nonlinear trend at higher loads and a deflection of 4 inches at 1.5 times the factored force effects, suggesting the onset of instability against overturning. For a shaft length shorter than 62 ft, the program will not converge to a solution, indicating that 62 ft is the minimum depth required for lateral geotechnical stability.

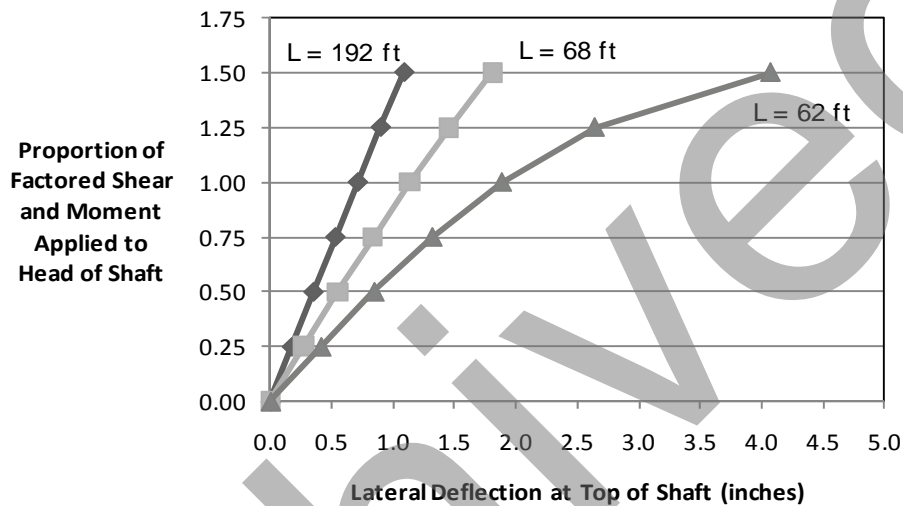


Figure A-5 Results of Pushover Analyses for Strength I Limit State

Next, the analysis is used to check the final design length of 192 ft. The load combinations given in Table A-5 are applied. In Figure A-5, the curve for shaft length of 192 ft exhibits stable behavior up through 1.5 times the factored force effects, and maximum deflection of 1.1 inches is well within 10 percent of the shaft diameter. Based on this analysis, the trial design therefore satisfies the geotechnical Strength I limit state criterion. The maximum moment computed at the load combination corresponding to the Strength I force effects (Load Case 4 in Table A-5) is  $M_{\max} = 40,981$  in-k.

A similar approach is applied to evaluation of the Extreme Event I limit state. The soil profile shown in Figure A-4, but without scour, is used to define the soil layers for the  $p$ - $y$  analysis. As described in Chapter 15, two load cases are analyzed. The factored force effects in the longitudinal direction are combined with 30 percent of the factored force effects in the transverse direction to form the first load case, while the second case consists of the factored force effects in the transverse direction combined with 30 percent of the factored force effects in the longitudinal direction. The first case is critical for the geotechnical strength limit state and will be presented herein. Referring to the factored force effects in Table A-1 for Extreme Event I, the factored shear and moment used in the analyses are given by:

$$V = \sqrt{(V_{\text{longitudinal}})^2 + (0.3 V_{\text{transverse}})^2} = \sqrt{(144.5)^2 + (0.3 \times 290.5)^2} = 168.7 \text{ kips}$$

$$M = \sqrt{(M_{\text{longitudinal}})^2 + (0.3 M_{\text{transverse}})^2} = \sqrt{(7,776)^2 + (0.3 \times 3,212)^2} = 7,835 \text{ k-ft}$$

The minimum factored axial compressive force of 2,810 kips is also applied. The drilled shaft is treated as a linearly elastic beam-column with properties as given in Table A-4, except that the distance from the top of the shaft to the ground surface in this case is zero, corresponding to no scour.

The analysis of lateral stability is again carried out by applying the shear (V) and moment (M) in increments up to maximum values of  $1/\phi$  times the factored force effects, where  $\phi$  = resistance factor. For Extreme Event I,  $\phi = 0.80$ , which is equivalent to multiplying the factored force effects by 1.25. The lateral load and moment are applied in multiples of 0.25 up to 1.25 times the factored values. The corresponding load combinations are summarized in Table A-6.

Figure A-6 shows the lateral head deflection plotted against the load multiplier for each of the five load increments, for lengths intended to establish the minimum required depth for lateral stability and also for the final trial shaft length of 192 ft. For a shaft length of 30 ft (fully embedded), the load-deflection behavior becomes nonlinear, suggesting that an unstable length is being approached, and a shaft of 27 ft in length shows deflection at the overstress load level (multiplier = 1.25) exceeding 6 inches. If the shaft length is decreased to 26 ft, the program will not converge. This exercise indicates that 30 ft is the approximate minimum shaft length required to satisfy lateral geotechnical strength for Extreme Event I. However, this length is less than the design scour depth of 38 ft, and therefore would not control the final drilled shaft lengths.

The final trial design length (192 ft) exhibits stable, approximately linear behavior up through 1.25 times the factored force effects, at a maximum deflection of 0.50 inches (Figure A-6). A length of 192 ft therefore provides adequate lateral geotechnical strength for the Extreme Event I limit state. The maximum moment computed at the load combination corresponding to the Extreme Event I factored force effects (Load Case 4 in Table A-6) is  $M_{\text{max}} = 107,810 \text{ in-k}$ .

**TABLE A-6 LOADING INCREMENTS FOR PUSHOVER ANALYSIS OF TRIAL SHAFT, EXTREME EVENT I**

Load Case	Multiple of Factored Force Effects	Shear Force, V (lbs)	Moment, M (in-lbs)	Axial Force, Q (lbs)
1	0.25	42,187	23,506,431	2,810,260
2	0.50	84,373	47,012,862	2,810,260
3	0.75	126,560	70,519,294	2,810,260
4	1.00	168,746	94,025,725	2,810,260
5	1.25	210,933	117,532,156	2,810,260



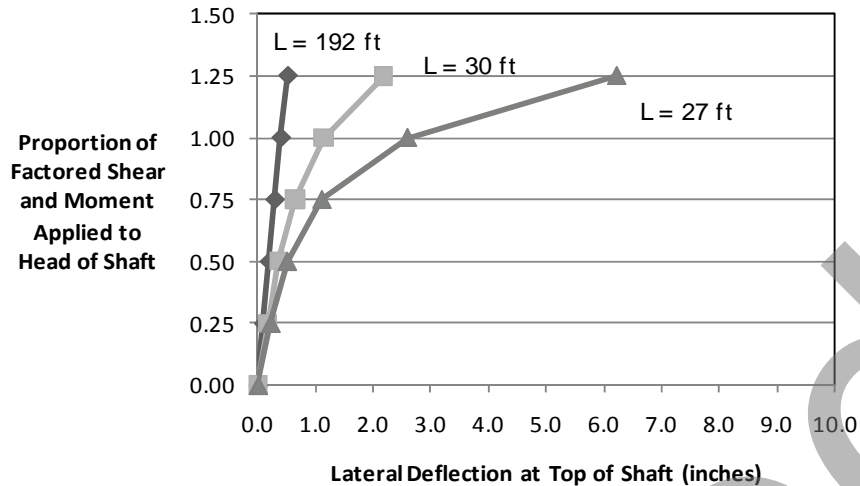


Figure A-6 Results of Pushover Analysis for Extreme Event I

**Substep 10.4** Analyze preliminary structural strength for flexure using factored force effects.

This step involves a quick check of potential flexural (moment) resistance of the final trial design (length = 192 ft), which is then compared to maximum bending moments obtained from the  $p$ - $y$  analyses. As noted above, the maximum moment from  $p$ - $y$  analysis is not sensitive to nonlinear behavior of the reinforced concrete. Therefore, values of moment based on the linear elastic model are suitable for this preliminary evaluation. Nominal moment resistance ( $M_N$ ) is approximated (see Chapter 12, Section 12.3.2.2) by:

$$\begin{aligned} \text{for } \rho = 1\% \quad M_N \text{ (ft-k)} &= 27 D^3 = 27 (8\text{ft})^3 = 13,824 \text{ ft-k} = 165,888 \text{ in-k} \\ \text{for } \rho = 1.5\% \quad M_N \text{ (ft-k)} &= 40 D^3 = 40 (8\text{ft})^3 = 20,480 \text{ ft-k} = 245,760 \text{ in-k} \end{aligned}$$

From the Strength I limit state pushover analysis,  $M_{\max} = 40,981$  in-k, and for the Extreme Event I pushover analysis,  $M_{\max} = 107,810$  in-k. Considering that resistance factors for flexure range from 0.75 to 0.90, it is clear that 8-ft diameter shafts with  $\rho$  in the range considered above (1.0% – 1.5%) will provide sufficient flexural resistance. There is no need at this point to consider larger diameters. Complete design for structural strength incorporating the nonlinear bending stiffness of the shaft is considered in Block 12 of the overall design process.

**Substep 10.5** Analyze service limit state (deformations) using factored loads.

The service limit state for lateral deformation is defined in terms of a tolerable lateral deflection at the top of the pier columns, where the columns are connected to the concrete pier cap. For this bridge, the tolerable lateral deflection established by the structural designer is 1 inch. The predicted deflection is based on structural modeling of the entire bridge, in which the foundations are modeled as beam-column elements assumed to be pinned at their lower end. The sections of drilled shafts with permanent casing, extending from 2 ft below MHW to the scour line, are modeled by assuming a diameter of 8.5 ft to account for additional stiffness provided by the larger diameter, cased section of the shaft. Lateral stiffness of the drilled shaft foundations below the scour line is modeled by using lateral springs, with the spring constants based on  $p$ - $y$  analysis, as illustrated in Figure A-2 and discussed previously for determination of foundation force effects. For the  $p$ - $y$  analyses, the shaft is specified to be a circular,

nonlinear reinforced concrete member, 102 inches and 96 inches diameter, reinforced with 40 #14 bars, and with 6-inches of concrete cover. This provides a steel area ratio ( $\rho$ ) of approximately 1.25 percent of the concrete gross cross-sectional area. Concrete compressive strength  $q_c = 4,000$  psi and yield strength of the steel reinforcement bars  $f_y = 60,000$  psi. Structural modeling of the bridge using Service I load combinations results in a predicted maximum lateral deflection of 1.0 inch at the joint between the pier columns and the pier cap. This deflection does not exceed the tolerable deflection of 1 inch. The trial drilled shaft design therefore is satisfactory for the LRFD Service I limit state for lateral deflection.

Substep 10.6 Define minimum length and diameter based on analyses.

If lateral loading only is considered, the minimum length is approximately 62 ft, for 8-ft diameter shafts, based on analysis of the geotechnical lateral stability for the Strength I limit state. Based on axial load considerations, described next, the minimum depth is 192 ft.

### **Step 11: Establish Diameter and Depths for Axial Loads**

Reference is made to the step-by-step procedure shown in Figure 13-2, “Flow Chart, Recommended Procedure for Axial Load Design”. Each step in Figure 13-2 is identified as a substep of Step 11 and explained as follows.

Substep 11.1 Define a detailed subsurface profile for each axial load case, including scour.

At each foundation location, divide the subsurface into a finite number of geomaterial layers; assign one of the following geomaterial types to each layer: cohesionless soil; cohesive soil; rock; IGM. The profile shown in Figure A-4 is applied to the axial load cases considered in this example.

Substep 11.2 Review the limit states to be satisfied and the corresponding axial load combinations and load factors for each foundation.

The following geotechnical limit states pertaining to axial loading are to be checked for the drilled shafts at Pier 2 of the proposed bridge:

Strength I (including effects of scour at the design flood)  
Geotechnical axial compression resistance of single shaft

Extreme Event I: Load combination including earthquake  
Geotechnical axial compression resistance of single shaft

Service I (including effects of scour at the design flood)  
Settlement (vertical deformation) of single shaft

Factored axial force effects for each limit state are given in Table A-1, based on structural modeling of the bridge.

Substep 11.3 For each limit state, assign corresponding geomaterial properties needed for evaluation of axial resistances for each geomaterial layer.

Geomaterial properties are shown in the idealized subsurface profile of Figure A-4, as discussed previously.

Substep 11.4 For each drilled shaft, select trial lengths and diameters for initial analyses.

As stated, the trial diameter is 8 ft. Only the analyses conducted for the final trial shaft length of 192 ft are presented here. This design length is measured from mudline to tip elevation (elevation -67 ft to elevation -259 ft).

Substeps 11.5 and 11.6 Compute values of nominal side resistance for all geomaterial layers through which the trial shaft extends and the nominal base resistance at the trial tip elevation. Select appropriate resistance factors and calculate factored resistances.

Calculations of nominal side and base resistances are readily carried out using a spreadsheet or other computational desktop tool. Table A-7 shows the calculation results for the Strength I limit state of this example. The table is divided into three areas: (A) side resistance in cohesionless soil layers; (B) side resistance in cohesive soil layers, and (C) base resistance. Table A-7 is followed by example calculations for a single layer within each group.

**TABLE A-7 SPREADSHEET CALCULATIONS FOR AXIAL COMPRESSIVE RESISTANCE, STRENGTH I LIMIT STATE**

<b>A. Side Resistance, Cohesionless Soil Layers</b>							
Geomaterial Layer No.	Thickness, ft (after scour)	Average $\phi$	Existing Ground: Mean Vertical Effective Stress, $\sigma'_v$ (psf)	After Scour: Mean Vertical Effective Stress, $\sigma'_v$ (psf)	Mean N-value ( $N_{60}$ )	$\sigma_p$ (psf) = $0.47(N_{60})^m$	
1	0	41	783	0	17	5,444	
2	27	44	2,817	845	75	13,263	
3	20	40	4,645	2,266	30	7,654	
5	10	40	6,223	3,844	36	8,539	
7	1.5	39	10,645	8,266	41	9,232	
Geomaterial Layer No.	OCR	$K = K_o$	$\beta = K \tan \phi$	Nominal Unit Side Resistance, $f_{SN} = \beta \sigma'_v$	Layer Nominal Side Resistance, $R_{SN}$ (lb)	Side Resistance Factor, $\phi_s$	Layer Factored Side Resistance, $\phi_s R_{SN}$ (lb)
1	7.0	1.23	1.07	0	0	NA	0
2	15.7	2.07	2.00	1,687	1,144,899	0.55	629,695
3	3.4	0.78	0.66	1,485	746,583	0.55	410,621
5	2.2	0.60	0.50	1,925	483,692	0.55	266,031
7	1.1	0.37	0.30	2,481	93,544	0.55	51,449
$\Sigma =$					2,468,718	$\Sigma =$	1,357,795
<b>B. Side Resistance, Cohesive Soil Layers</b>							
Geomaterial Layer No.	Thickness (ft)	Average Undrained Shear Strength (psf)	Coefficient $\alpha$	Nominal Unit Side Resistance, $f_{SN} = \alpha c_u$	Layer Nominal Side Resistance, $R_{SN}$ (lb)	Side Resistance Factor, $\phi_s$	Layer Factored Side Resistance, $\phi_s R_{SN}$ (lb)
4	15	1,750	0.55	963	362,854	0.45	163,284
6	80.5	2,300	0.55	1,265	2,559,330	0.45	1,151,698
$\Sigma =$					2,922,184	$\Sigma =$	1,314,983
<b>C. Base Resistance, Layer 7, Cohesionless Soil</b>							
Geomaterial Layer No.	Mean N-value for 2-Diameters Below Tip	Nominal Unit Base Resistance = $0.6 N_{60}$ (tsf)	Nominal Base Resistance, $R_{BN}$ (lb)	Base Resistance Factor, $\phi_B$	Factored Base Resistance, $\phi_B R_{BN}$ (lb)		
7	41	24.6	2,473,062	0.50	1,236,531		
<b>Summation of Factored Resistances =</b>			<b>3,909 kips</b>				

A. Consider geomaterial Layer 3 for the purpose of illustrating the beta method of computing side resistance of a cohesionless soil layer. The computations follow the equations presented in Chapter 13 and in Appendix C. The example is for Strength I limit state, therefore full scour is taken into account.

- Establish mean value of  $N_{60}$  and mean vertical effective stress  $\sigma'_v$

$$\text{mean } N_{60} = 30, \text{ mean } \sigma'_v = 4,645 \text{ psf (no scour); mean } \sigma'_v = 2,266 \text{ psf (full scour);}$$

- Establish  $\phi'$  by correlation to  $(N_1)_{60}$

$$\text{mean } (N_1)_{60} = 21 \text{ (see Table A-3)}$$

$$\phi' = 27.5 + 9.2 \log[(N_1)_{60}] = 27.5 + 9.2[\log(21)] = \underline{40 \text{ degrees}}$$

$$\delta = \phi = 40^\circ$$

- Establish preconsolidations stress ( $\sigma'_p$ ) by correlation to  $N_{60}$  and calculate overconsolidation ratio (OCR)

$$\sigma'_p = p_a [0.47 (N_{60})^m] = 2,116 \text{ psf } [0.47 (30)^{0.6}] = 7,654 \text{ psf}$$

$$\text{OCR} = \sigma'_p / \sigma'_v = 7,654 / 2,266 = 3.38$$

- Calculate  $K_o$  using estimated values of OCR and  $\phi'$

$$K_o = (1 - \sin \phi') \text{OCR}^{\sin \phi'} = (1 - \sin 40^\circ) 3.38^{\sin 40^\circ} = 0.78 \leq K_p$$

- Calculate  $\beta$  and average nominal unit side resistance  $f_{SN}$

$$\beta = K \tan \delta = 0.78 \tan 40^\circ = 0.66$$

$$f_{SN} = \beta \times \sigma'_v = 0.66 (2,266 \text{ psf}) = 1,485 \text{ psf}$$

\*note that  $\sigma'_v$  accounts for scour

- Calculate Layer 3 nominal side resistance  $R_{SN}$

$$R_{SN} = \pi B \Delta z f_{SN} = \pi (8 \text{ ft}) (20 \text{ ft}) 1,485 \text{ lb/ft}^2 = 746,583 \text{ lb}$$

- Select appropriate resistance factor and calculate factored resistance

By Table 10-5, the resistance factor for side resistance of a drilled shaft under axial compression by the  $\beta$ - method is 0.55, assuming that load tests will not be performed. The factored side resistance of geomaterial Layer 3 therefore is:

$$(\phi_s R_{SN})_{i=3} = 0.55 (746,583 \text{ lb}) = 410,621 \text{ lb}$$

B. Consider geomaterial Layer 4 for illustrating the computation of side resistance in a cohesive soil layer. In accordance with Chapter 13, the alpha method is used for undrained side resistance of shafts in cohesive soil.

- Establish the mean value of soil undrained shear strength

Based on unconsolidated undrained (UU) triaxial tests, mean  $s_u = 1,750$  psf

- Select value of the coefficient  $\alpha$ :

$$s_u / p_a = 1,750 / 2,116 = 0.82 < 1.5 \quad \text{therefore } \alpha = 0.55$$

- Calculate layer nominal unit side resistance

$$f_{SN} = \alpha s_u = 0.55 (1,750 \text{ psf}) = 962.5 \text{ psf}$$

- Calculate nominal layer side resistance:

$$R_{SN} = \pi B \Delta z f_{SN} = \pi (8 \text{ ft}) (15 \text{ ft}) 962.5 \text{ lb/ft}^2 = 362,854 \text{ lb}$$

- Select applicable resistance factor and calculate Layer 4 factored side resistance:

Table 10-5 specifies a resistance factor of 0.45 for side resistance in compression by the  $\alpha$ -method, assuming that load tests will not be performed.

$$(\phi_s R_{SN})_{i=4} = 0.45 (362,854 \text{ lb}) = \underline{\underline{163,284 \text{ lb}}}$$

C. Base resistance is calculated for the trial design length of 192 ft, which places the tip in Layer 7. Applying the equations presented in Chapter 13, the nominal unit base resistance is given by:

$$q_{BN} = 0.60 N_{60} = 0.60 (41) = 24.6 \text{ tsf} = 49.2 \text{ k/ft}^2$$

in which  $N_{60}$  is the average field N-value over a depth of two shaft diameters beneath the tip. Nominal base resistance is the product of unit base resistance and the cross-sectional area of the shaft:

$$R_{BN} = \pi/4 (8 \text{ ft})^2 49.2 \text{ k/ft}^2 = 2,473 \text{ kips}$$

By Table 10-5, the resistance factor for base resistance in compression is 0.50, assuming that load tests will not be performed. The factored base resistance is then given as:

$$(\phi_B R_{BN}) = 0.50 (2,473 \text{ kips}) = \underline{\underline{1,237 \text{ kips}}}$$

Table A-7 also shows the summation of factored side resistance for the cohesionless soil layers, summation of factored side resistance for the cohesive soil layers, and the factored base resistance. Using these values, the summation of factored resistances is then given by:

$$\sum \phi_i R_i = \sum_{i=1}^n \phi_{s,i} R_{SN,i} + \phi_B R_{BN} = 1,357,795 + 1,314,983 + 1,236,531 = 3,909,309 \text{ lb} = \underline{\underline{3,909 \text{ kips}}}$$

Referring to Table A-1, the factored maximum axial compression force for Strength I limit state is 3,389 kips. The limit state check is given by:

$$3,389 \text{ kips} < 3,909 \text{ kips}$$

Or, the summation of factored force effects does not exceed the summation of factored resistances. The trial design therefore satisfies Strength I for geotechnical axial compressive resistance of a single shaft.

Trial designs with lengths less than 192 ft, which place the drilled shaft tips in Geomaterial Layer 6 (stiff clay), were checked for Strength I. The effect of the lower base resistance associated with Layer 6 is to decrease the factored resistance to a value that is less than the factored axial force effects. Therefore, 192 ft is the minimum length required to satisfy the LRFD Strength I criterion.

A similar analysis is conducted for a limit state check of Extreme Event I (earthquake). In this case, zero scour is assumed, and the full soil profile shown in Figure A-4 is taken into account. The spreadsheet calculations, presented in Table A-8, are similar to those made for the Strength I limit state, except that all resistance factors are equal to 1.00. Also, the absence of scour results in lower values of overconsolidation ratio but higher values of vertical effective stress, resulting in higher side resistances in the cohesionless soil layers.

**TABLE A-8 SPREADSHEET CALCULATIONS OF AXIAL COMPRESSIVE RESISTANCE FOR EXTREME EVENT I LIMIT STATE**

<b>A. Side Resistance, Cohesionless Soil Layers</b>							
Geomaterial Layer No.	Thickness, ft (no scour)	Average $\phi$	Existing Ground: Mean Vertical Effective Stress, $\sigma'_v$ (psf)	After Scour: Mean Vertical Effective Stress, $\sigma'_v$ (psf)	Mean N-value ( $N_{60}$ )	$\sigma_p$ (psf) = $0.47(N_{60})^m$	
1	25	41	783	783	17	5,444	
2	40	44	2,817	2,817	75	13,263	
3	20	40	4,645	4,645	30	7,654	
5	10	40	6,223	6,223	36	8,539	
7	1.5	39	10,645	10,645	41	9,232	
Geomaterial Layer No.	OCR	$K = K_o$	$\beta = K \tan\phi$	Nominal Unit Side Resistance, $f_{SN} = \beta \sigma'_v$	Layer Nominal Side Resistance, $R_{SN}$ (lb)	Side Resistance Factor, $\phi_s$	Layer Factored Side Resistance, $\phi_s R_{SN}$ (lb)
1	7.0	1.23	1.07	835	524,776	1.00	524,776
2	4.7	0.90	0.87	2,437	2,449,741	1.00	2,449,741
3	1.6	0.49	0.41	1,919	964,754	1.00	964,754
5	1.4	0.44	0.37	2,286	574,507	1.00	574,507
7	0.9	0.37	0.30	3,195	120,463	1.00	120,463
$\Sigma =$					4,634,241	$\Sigma =$	<b>4,634,241</b>
<b>B. Side Resistance, Cohesive Soil Layers</b>							
Geomaterial Layer No.	Thickness (ft)	Average Undrained Shear Strength (psf)	Coefficient $\alpha$	Nominal Unit Side Resistance, $f_{SN} = \alpha c_u$	Layer Nominal Side Resistance, $R_{SN}$ (lb)	Side Resistance Factor, $\phi_s$	Layer Factored Side Resistance, $\phi_s R_{SN}$ (lb)
4	15	1,750	0.55	963	362,854	1.00	362,854
6	80.5	2,300	0.55	1,265	2,559,330	1.00	2,559,330
$\Sigma =$					2,922,184	$\Sigma =$	<b>2,922,184</b>
<b>C. Base Resistance, Layer 7, Cohesionless Soil</b>							
Geomaterial Layer No.	Mean N-value for 2-Diameters Below Tip	Nominal Unit Base Resistance = $0.6 N_{60}$ (tsf)	Nominal Base Resistance, $R_{BN}$ (lb)	Base Resistance Factor, $\phi_B$	Factored Base Resistance, $\phi_B R_{BN}$ (lb)		
7	41	24.6	2,473,062	1.00	2,473,062		
<b>Summation of Factored Resistances =</b>			<b>10,029 kips</b>				

As shown at the bottom of Table A-8, the summation of factored resistances equals 10,029 kips. From Table A-1, the maximum factored axial force effect for Extreme Event I is 2,823 kips. The limit state check is given by:

$$2,823 \text{ kips} < 10,029 \text{ kips}$$

Or, the summation of factored force effects is less than the summation of factored resistances; therefore the trial design length of 192 ft satisfies Extreme Event I for axial compressive resistance of single shafts.

The final geotechnical limit state to be evaluated for axial loading is Service I. The bridge structural designer has established a tolerable settlement of 2.0 inches for single shafts at Pier 2. Applying the first-order approximation involving the use of normalized displacement curves for single drilled shafts in soil (as shown in Figure 13-10) the resistance corresponding to a downward displacement of 2 inches can be estimated as follows. Referring to Table A-7:

$$\text{Nominal Resistance} = R_{SN} + R_{BN} = (2,468.7 + 2,922.2) + (0.71) 2,473.1 = 7,147 \text{ kips}$$

in which the factor 0.71 is used to relate base resistance at 5 percent normalized displacement to base resistance at 4 percent normalized displacement, as discussed in Chapter 13 (see pp. 13-29 and 13-30).

$$\text{Normalized displacement} = \delta_{\text{tolerable}} / B = 2 \text{ in} / 96 \text{ in} (100\%) = 2.1\%$$

Entering Figure 13-10, reproduced below as Figure A-7, with a normalized displacement of 2.1% yields a normalized load of 80% of the failure threshold.

$$\text{Axial Compressive Force} = R_{\text{service}} + W_{\text{shaft}} = 0.80 (7,147) = 5,718 \text{ kips}$$

$$R_{\text{service}} = 5,718 - W_{\text{shaft}} = 6,291 - [(145 - 62.4) \text{ lb/ft}^3 \cdot \frac{1}{4} \pi (8 \text{ ft})^2 \cdot 192 \text{ ft}] = 6,291 - 797 = 4,921 \text{ kips}$$

The limit state check is then carried out by comparing the factored axial force effect for Service I to the factored axial resistance at the tolerable displacement:

$$2,835 \text{ kips} < 4,921 \text{ kips}$$

or, the factored force effect is less than the axial resistance developed at the tolerable displacement, and therefore the trial design satisfies the LRFD Service I limit state.

Figure A-7 is also used to make a first-order estimate of the expected settlement under the Service I axial force effect. At the Service I load of 2,835 kips:

$$\begin{aligned} \text{Compressive Force} &= 2,835 + W_{\text{shaft}} = 2,835 + 797 = 3,632 \text{ kips} \\ \text{Normalized Compressive Force} &= 3,632 \text{ kips} / 7,147 \text{ kips} = 0.51 \text{ or } 51\% \end{aligned}$$

From Figure A-7, for a normalized compressive force of 51 percent, the normalized displacement is approximately 0.41 percent and:

$$\delta = .0041 \times 96 \text{ inches} = 0.39 \text{ inches}$$

The estimated settlement is well within the tolerable settlement of 2 inches. It is concluded that more refined settlement analyses are not necessary.

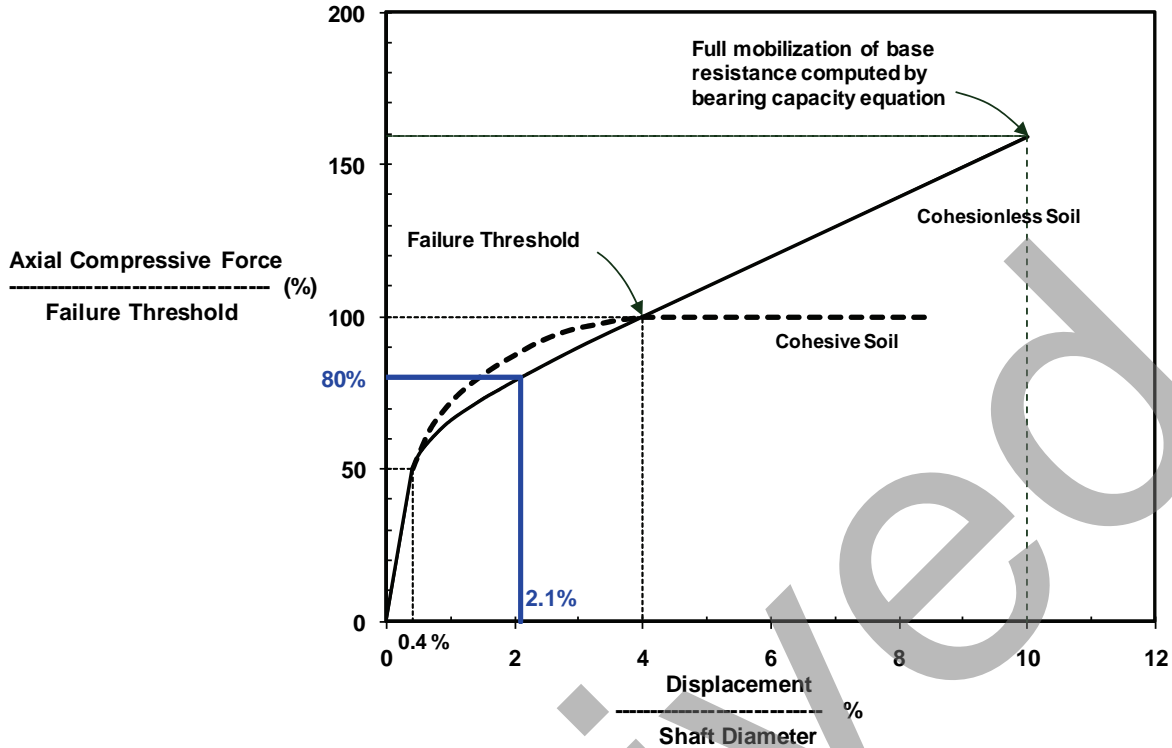


Figure A-7 Normalized Load-Displacement Curve for Analysis of Service Limit State

$$V = \sqrt{(V_{longitudinal})^2 + (V_{transverse})^2} = \sqrt{(36.98)^2 + (9.63)^2} = 38.21 \text{ kips}$$

$$M = \sqrt{(M_{longitudinal})^2 + (M_{transverse})^2} = \sqrt{(1,686.87)^2 + (221.68)^2} = 1,701.37 \text{ kip-ft}$$

$$V = \sqrt{(V_{longitudinal})^2 + (1/3 V_{transverse})^2} = \sqrt{(144.52)^2 + (0.33 \times 290.48)^2}$$

$$M = \sqrt{(M_{longitudinal})^2 + (1/3 M_{transverse})^2} = \sqrt{(7,776.42)^2 + (0.33 \times 3,212.32)^2}$$

### Step 12: Finalize Structural Design of the Shafts and Connection to Structure

In Substep 10.4, above, it was shown that 8-ft diameter shafts with steel reinforcement ratios ( $\rho$ ) in the range of 1 to 2 percent should be sufficient to satisfy structural strength requirements due to flexure. In Substep 10.5, analysis shows that  $\rho = 1.25$  percent is just sufficient to satisfy the service limit state requirement for 1 inch of lateral displacement at the pier cap. In this section, the trial design consisting of 8-ft diameter, 192-ft long shafts with  $\rho = 1.25$  percent will be checked for structural resistance, for Strength I and Extreme Event I limit states. The longitudinal reinforcing consists of 40 No. 14 bars, Grade 60 (cross-sectional area  $A_s = 90 \text{ in}^2$ ). Initially, the critical values of factored axial load, shear, and moment and the depths at which they occur are determined. The minimum transverse shear reinforcement is then calculated. Axial, shear, and flexural resistances are then checked and spiral reinforcement is selected to satisfy shear resistance and constructability requirements. The procedure described herein follows the steps for structural design presented in Section 16.7.2 of this manual.



**Substep 12.1** Determine the critical values of factored axial, moment, and shear force effects and their corresponding locations along the length of the shaft.

For this step, the shaft is analyzed using a computer program based on the  $p$ - $y$  method, with the factored force effects given in Table A-1 for the Strength I and Extreme Event I limit states. The reinforced concrete drilled shaft is modeled by taking into account the nonlinear relationship between moment and flexural stiffness ( $EI$ ) that accounts for cracking of the concrete. For Extreme Event I, the critical load case consists of applying the full factored force effect in the longitudinal direction with 30 percent of the force effects in the transverse direction. For each load case, graphs of moment versus depth and shear versus depth are generated and the program output file is inspected to determine maximum values of moment and shear and the corresponding depths at which they occur. Figures A-8 and A-9 show the resulting moment and shear diagrams for Strength I and Extreme Event I, respectively. Table A-9 summarizes the critical values of moment, shear, and critical depths for Strength I and Extreme Event I force effects. The two cases analyzed for Strength I correspond to the minimum and maximum values of factored compression. The case with maximum axial compression (3,390 kips) is critical for moment and shear, and is used in the limit state check.

**TABLE A-9 SUMMARY OF CRITICAL MOMENTS AND SHEAR FOR STRUCTURAL DESIGN**

Limit State	$M_{\max}$		Depth of $M_{\max}$ (ft)	$V_{\max}$ (kips)	Depth of $V_{\max}$ (ft)	Applied Axial Force (kips)
	(inch-kips)	(ft-kips)				
Strength I:	46,300	3,858	42.2	156.6	55.7	3,390
	44,612	3,718	42.2	149.0	55.7	2,673
Extreme Event I:	106,766	8,897	7.7	422.8	21.1	2,823

**Substep 12.2** Check whether the factored axial load is within the factored axial strength  $\phi(P_n)$  of the drilled shaft using Equation (16-6).

Referring to Chapter 16, the factored axial resistance, given the trial shaft properties, is given by:

$$P_r = \phi P_n = \phi \beta [0.85 f'_c (A_g - A_s) + A_s f_y] = 0.75(0.85) [0.85 \times 4(7,238 - 90) + 90(60)] = 18,937 \text{ kips}$$

The limit state check is conducted by comparing the maximum factored axial force effect, which corresponds to the Strength I limit state and is taken from Table A-1, to the factored axial structural resistance, or:

$$3,390 \text{ kips} \ll 18,937 \text{ kips}$$

The maximum factored axial compressive force effect is well within the factored axial compressive resistance, easily satisfying the LRFD Strength I limit state for structural axial resistance.

**Substep 12.3** Check to see whether the concrete section has adequate shear capacity with the minimum transverse reinforcement ratio as specified in Section 16.4.

The first step in this evaluation is to calculate the minimum transverse reinforcement, given as follows:

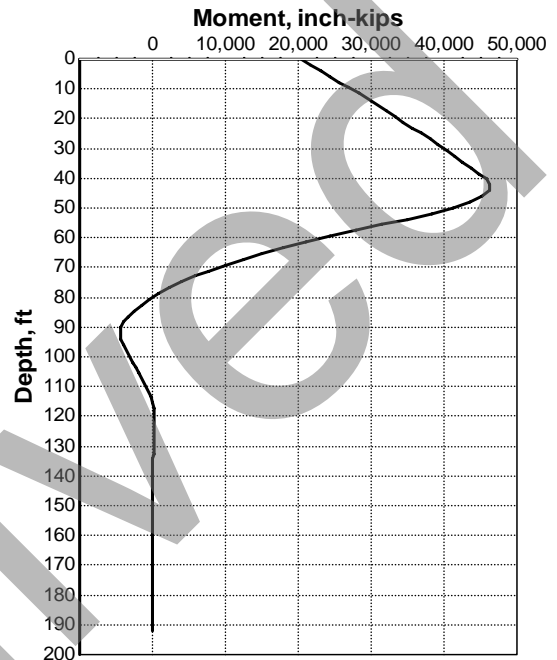
$$\rho_s \geq 0.45 \left( \frac{A_g}{A_c} - 1 \right) \frac{f'_c}{f_y h} \tag{16-4}$$

where:  $A_g = \frac{\pi}{4}(96 \text{ in})^2 = 7,238 \text{ in}^2$

Assuming the transverse reinforcement will consist of Grade 60 #6 bars (diameter = 0.75 inch) bundled in groups of two:

$$A_c = \frac{\pi}{4}(96 \text{ in} - 12 \text{ in} + 2(0.75 \text{ in}))^2 = 5,741 \text{ in}^2$$

assuming 6-inch cover and #6 spiral



$$A_c = \frac{\pi}{4}(96 \text{ in} - 12 \text{ in} + 2(1 \text{ in}))^2 = 5,809 \text{ in}^2$$

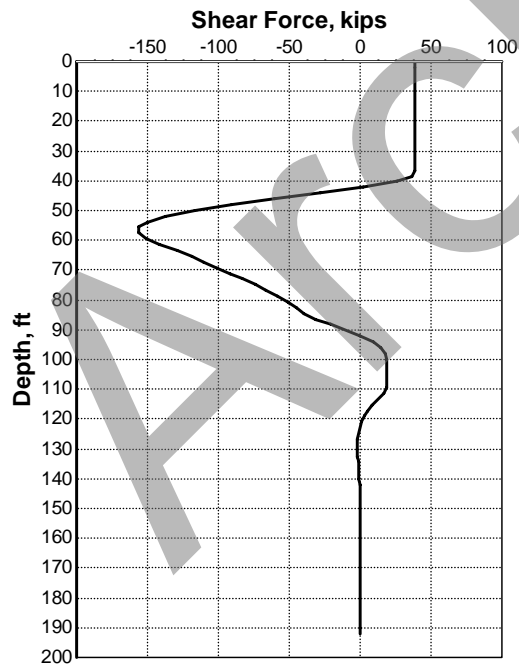


Figure A-8 Moment and Shear versus Depth, Drilled Shaft Under Strength I Force Effects (Ground surface at elevation -67 ft)

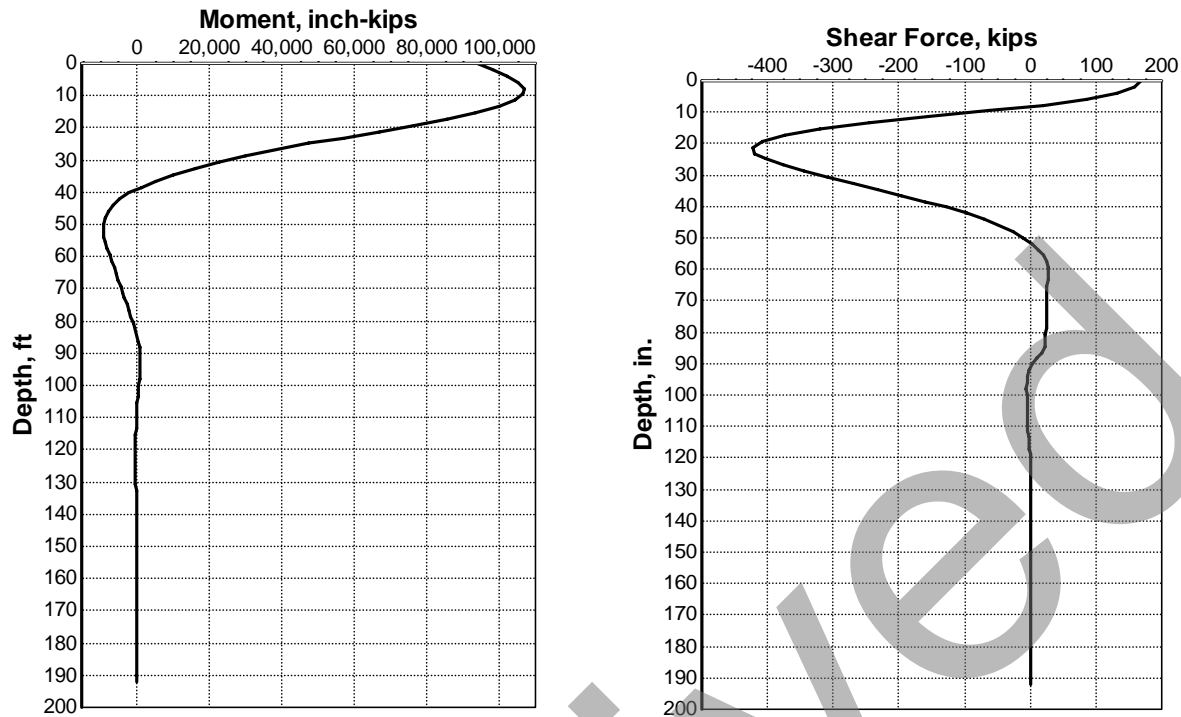


Figure A-9 Moment and Shear versus Depth, Drilled Shaft Under Extreme Event I Force Effects (Ground surface at elevation -29 ft)

$$\rho_s \geq 0.45 \left( \frac{A_g}{A_c} - 1 \right) \frac{f'_c}{f_{yh}}$$

$$A_g = \frac{\pi}{4} (96 \text{ in})^2 = 7,238 \text{ in}^2$$

$$A_c = \frac{\pi}{4} (96 \text{ in} - 12 \text{ in} + 2(1 \text{ in}))^2 = 5,809 \text{ in}^2$$

$$f'_c = 4 \text{ ksi} \quad \text{and} \quad f_{yh} = 60 \text{ ksi}$$

which are used to calculate the minimum required transverse steel by:

$$\rho_s \geq 0.45 \left( \frac{7,238}{5,741} - 1 \right) \frac{4}{60} = .0078 = 0.78\%$$

The percentage steel for spiral reinforcement is defined as the ratio of the volume of steel over the depth of one pitch ( $s$ ) to the volume of concrete effective in resisting shear, and can be expressed as:

$$\rho_s = \frac{4 a_s [D_c - d_b]}{s D_c^2}$$

which can be rearranged to determine the minimum required pitch ( $s$ ):

$$s = \frac{4 a_s [D_c - d_b]}{\rho_s D_c^2} = \frac{4 (88) [85.5 - .75]}{.0078 (85.5)^2} = 5.23 \text{ in}$$

The above calculations demonstrate that bundled #6 spirals on a 5-inch pitch satisfies the minimum shear reinforcement requirement. Note that this bridge is in Seismic Zone 1, and therefore the maximum allowable pitch is 6 inches. Alternatively, a single #8 spiral on a 4-inch pitch also satisfies the minimum shear reinforcement requirement. However, the option with bundled #6 spirals on a 5-inch pitch provides greater clear space for concrete passage and is selected for constructability.

The next step is to evaluate the factored shearing resistance of the section, assuming bundled #6 spirals on a 5-inch pitch. The nominal shearing resistance ( $V_n$ ) is given by the smaller of the following two values (Equations 16-12a and 16-12b):

$$V_n = V_c + V_s \quad \text{or} \quad V_n = 0.25 f'_c b_v d_v$$

in which  $V_c$  = nominal shear resistance provided by the concrete and  $V_s$  = nominal shearing resistance provided by the transverse reinforcement steel. In the second expression, the dimensions  $b_v$  and  $d_v$  refer to the width and effective depth of a rectangular cross-section, and the product  $b_v d_v$  represents the cross-sectional area that is effective in resisting shear,  $A_v$ . For a circular cross-section, this area can be approximated by:

$$A_v = 0.9 D \left[ \frac{D}{2} + \frac{D_r}{\pi} \right] = 0.9 (96 \text{ in}) \left[ \frac{96 \text{ in}}{2} + \frac{82.3 \text{ in}}{\pi} \right] = 6,411 \text{ in}^2$$

The nominal resistances contributed by the concrete ( $V_c$ ) and the steel ( $V_s$ ) are given by:

$$V_c = 0.0136 \beta \sqrt{f'_c} A_v = 0.0136 (2) \sqrt{4 \text{ ksi}} (6,411 \text{ in}^2) = 348.8 \text{ kips}$$

$$V_s = \frac{A_{vs} f_y d_v (\cot \theta + \cot \alpha) \sin \alpha}{s}$$

$$= \frac{(0.88)(60 \text{ ksi})(66.8 \text{ in})(\cot 45^\circ + \cot 1.7^\circ) \sin 1.7^\circ}{5 \text{ in}} = 726.0 \text{ kips}$$

giving:

$$V_n = V_c + V_s = 348.8 + 726.0 = 1,075 \text{ kips}$$

Evaluating the second expression:

$$V_n = 0.25 f'_c b_v d_v = 0.25 (4 \text{ ksi}) 6,411 \text{ in}^2 = 6,411 \text{ kips} > 1,075 \text{ kips}$$

Therefore, the lesser value of 1,075 kips is taken as the nominal shearing resistance of the trial section with minimum spiral reinforcement. The factored resistance is obtained by applying the resistance factor for shear to the nominal shear resistance:

$$V_r = \phi V_n = 0.90 (1,075 \text{ kips}) = 968 \text{ kips}$$

Limit state checks are then carried out by comparing the factored shear force effect (Table A-9) to the factored shear resistance:

$$\text{For the Strength I limit state:} \quad 156.6 \text{ kips} < 968 \text{ kips}$$

For the Extreme Event I limit state: 425.6 kips < 968 kips

$$\rho_s \geq 0.45 \left( \frac{7,238}{5,809} - 1 \right) \frac{4}{60} = .0074 = 0.74\% \quad \rho_s = \frac{4 a_s [D_c - d_b]}{s D_c^2}$$

$$s = \frac{4 a_s [D_c - d_b]}{\rho_s D_c^2} = \frac{4 (785)(86 - 1)}{.0074 (86)^2} = 4.88 \text{ in} > 4 \text{ in}$$

$$A_v = 0.9 D \left[ \frac{D}{2} + \frac{D_r}{\pi} \right] = 0.9 (96 \text{ in}) \left[ \frac{96 \text{ in}}{2} + \frac{82.3 \text{ in}}{\pi} \right] = 6,411 \text{ in}^2$$

$$V_c = 0.0136 \beta \sqrt{f'_c} A_v = 0.0136 (2) \sqrt{4 \text{ ksi}} (6,411 \text{ in}^2) = 348.8 \text{ kips}$$

$$V_s = \frac{A_{vs} f_y d_v (\cot \theta + \cot \alpha) \sin \alpha}{s}$$

$$= \frac{(0.785 \text{ in}^2)(60 \text{ ksi})(66.8 \text{ in})(\cot 45^\circ + \cot 1.35^\circ) \sin 1.35^\circ}{4 \text{ in}} = 804.9 \text{ kips}$$

Thus demonstrating the trial design with the minimum required transverse steel satisfies the structural strength requirements for shear, for Strength I and Extreme Event I limit states.

Substep 12.4 Determine an amount and distribution of longitudinal steel required for the section to resist the axial load and moment.

This step requires the designer to develop an interaction diagram, a curve defining the combination of axial compression (P) and moment (M) exceeding the strength of a reinforced concrete beam column, as described in Chapter 16. For this example, a commercially available *p-y* computer program was executed with the trial shaft dimensions and nonlinear bending properties to determine the moment required to achieve the strength limit state for a range of axial compression values from zero to the nominal crushing strength of 29,703 kips. The trial design consists of 4,000 psi concrete, 40 #14 bars with  $f_y = 60$  ksi, giving a steel ratio of 1.25%. The resulting P-M interaction diagram is shown in Figure A-10 as the nominal (or unfactored) interaction curve. These values are then factored according to AASHTO specifications as described in Section 16.7 of this manual. For axial strain values up to 0.002, compression controls and the resistance factor is taken as 0.75. For strain in the extreme tension fiber equal to or exceeding 0.005, the resistance factor is taken as 0.90. Between these limits of strain, the resistance factor is interpolated linearly between 0.75 and 0.90. Factored resistances are computed by multiplying both  $P_n$  and  $M_n$  by the appropriate single value of  $\phi$ . The resulting factored interaction curve determined in this way is also shown in Figure A-10.

Limit state checks for flexure are then carried out by plotting the points representing the combination of factored axial and moment force effects for each applicable limit state on the P-M interaction diagram. These points are shown on Figure A-10 for the Strength I (blue) and Extreme Event I (red) limit states. The values of factored force effects (P and M) are those given in Table A-9. The LRFD requirement is that the P-M points lie within the factored interaction curves. For the Strength I limit state, the blue point must lie within the curve labeled "Factored Interaction Curve". For Extreme Event I, the resistance factors are taken equal to 1.0, which means that the factored resistances are equivalent to the nominal resistances. The point labeled Extreme Event I must therefore lie within the curve labeled "Nominal

Interaction Curve”. In this case, both points are well within the respective interaction curves, and therefore the trial structural design is satisfactory for flexural resistance for both Strength I and Extreme Event I limit states.

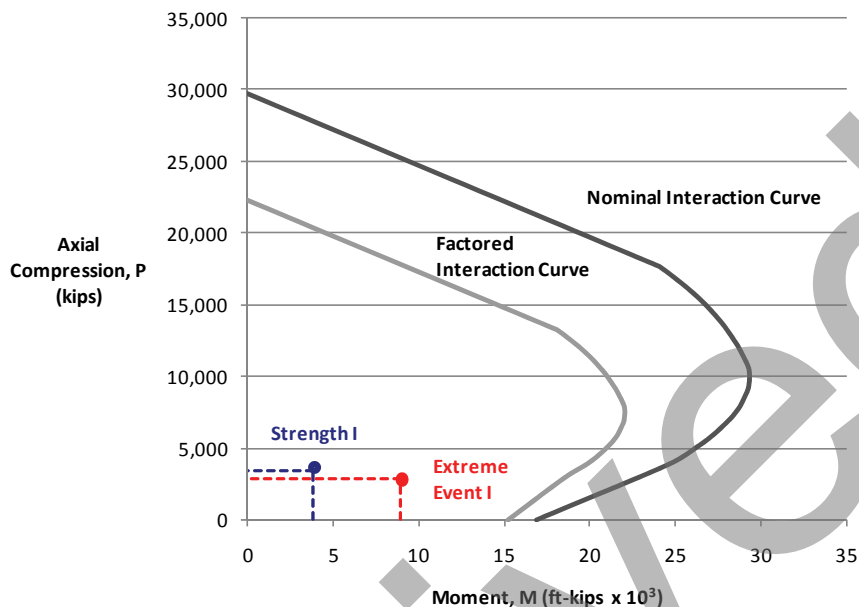


Figure A-10 P-M Interaction Diagram for Trial Shaft Structural Analysis

The strength limit state analysis above suggests that the amount of longitudinal reinforcing could be reduced. However, the Service I limit state criterion that limits lateral deflection of the pier cap restricts the longitudinal steel to  $\rho = 1.25$  percent in order to provide sufficient flexural stiffness to limit lateral deformation at the pier cap to 1 inch.

**Substep 12.5** Select appropriate ties or spirals according to AASHTO and ensure the spacing between reinforcement satisfies requirements for constructability.

As stated in Chapter 16 (Section 16.4), AASHTO specifications require that the minimum amount of transverse steel extend from the top of the drilled shaft to a depth of at least three diameters below the calculated depth of moment fixity. Based on the  $p$ - $y$  analyses of the trial shaft for Strength I and Extreme Event I, the maximum depth of moment fixity is 110 ft below the existing mudline elevation (see Figure A-8). Adding three shaft diameters (24 ft) establishes a depth of 134 ft below mudline elevation as the depth to which minimum transverse reinforcement is required. Also considering that the drilled shafts extend from the existing mudline elevation (-29 ft) upward to the joint with the pier columns at elevation + 5.0 ft, the total shaft length over which the minimum transverse steel is required is approximately 168 ft. The spiral size and pitch required to meet the minimum transverse steel requirement has been calculated above, and consists of: bundled #6 spirals, 60 ksi, at a pitch of  $s = 5.0$  inch. Below the depth corresponding to three diameters below moment fixity, the transverse reinforcement can be reduced to a size and spacing that will provide a stable reinforcing cage for handling and constructability, for example single #6 spirals on 12-inch pitch.

The clear spacing between vertically bundled #6 spirals on a 5-inch pitch is 3.5 inches. As stated in Chapter 16, “The clear distance between parallel transverse reinforcing bars shall be not less than 5 times the maximum aggregate size or 5.0 inches, whichever is greater (AASHTO 5.13.4.5.2) except where

tighter spacing is required for seismic requirements". Since AASHTO provisions make it necessary to use the minimum transverse steel and a pitch of 5 inches, the minimum recommended spacing of 5 inches is not satisfied. The concrete mix design should be limited to a maximum aggregate size of 0.7 inches in order to provide a clear spacing of 5 times.

Longitudinal bars considered above, 40 #14 bars,  $f_y = 60$  ksi, satisfy all of the strength and service limit state requirements. If it is assumed that the drilled shafts will be constructed under slurry using tremie concrete, it is recommended to provide clear spacing between parallel longitudinal bars of 10 times the maximum aggregate size and to bundle bars to achieve maximum clear spacing. If the #14 bars (dia = 1.69 inches) are bundled in the radial direction with 2 bars per bundle, and considering 6 inches of cover, the clear spacing is given by:

$$\text{Circumferential spacing} = \frac{\pi \times [96 \text{ inches} - 2(6 \text{ inches}) - 2.25 \text{ inches}]}{20 \text{ bar bundles}} - 1.69 \text{ inches} = 11.528 \text{ inches}$$

which satisfies the clear spacing requirement. Note that only one bar diameter (1.69 inch) was considered in the above calculation since the two-bar bundles are to be arranged in a radial pattern (see Figure A-11) to increase the clear spacing between the bars.

Below the depth at which the drilled shafts behave as columns, which can be taken as the depth below which bending moment is less than 5% of the maximum moment, or approximately 110 ft below existing mudline, the minimum recommended reinforcement ratio of 0.5 percent can be used. If one bar of each 2-bar bundle of #14 bars is discontinued below this depth, the steel ratio is approximately 0.6 percent, a practical solution and one that provides continuity in the reinforcement cage.

Connection to Pier Columns. For constructability of the drilled shafts, a construction joint is located at the connection between the drilled shafts and the pier columns, at elevation +5.0 ft, which is approximately 2.4 ft above mean high water level (M.H.W.). Figure A-11 shows a partial elevation of the drilled shafts at Pier 2 and selected cross-sections of the drilled shafts for the cased (Section A-A) and uncased (Section B-B) lengths. The column and shaft reinforcement are the same for the drilled shafts and pier columns (40 #14 bars in bundles of two). Mechanical couplers are specified for splicing the longitudinal bars at the construction joint, with connections between individual bars within each 2-bar bundle to be staggered. The transverse steel for the drilled shafts, consisting of bundled #6 spiral at  $s = 5$  inches, also extends into the pier columns and is continued 5 ft into the pier cap. The interior bar of each 2-bar bundle is to be straight and also embedded 5 ft into the pier cap. Following construction of the superstructure, the permanent casing is to be cut from the top, to 2 ft below the mean low water elevation (M.L.W.).

### **Constructability**

Constructability issues associated with this project included: subsurface stratigraphy consisting of alternating layers of saturated coarse-grained and fined-grained soils; over-water construction; partial-length permanent casing; and a design with marginal clear spacing between transverse reinforcing bars.

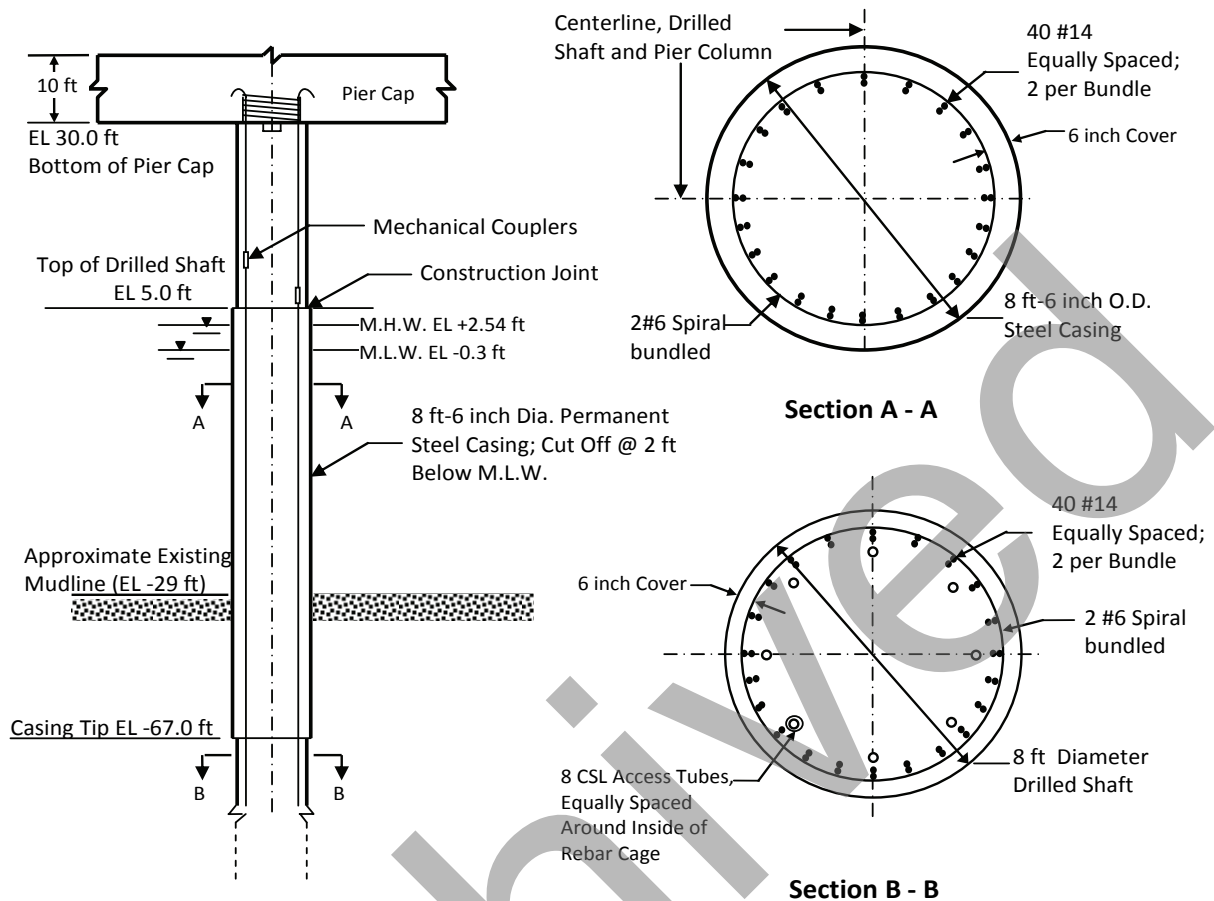


Figure A-11 Elevation and Cross-Sections of Drilled Shafts at Pier 2.

To address borehole stability, the contractor's installation plan called for the use of a polymer-based drilling fluid. Slurry properties were controlled in accordance with manufacturer-provided specifications. Prior to concrete placement, high silt content in the polymer slurry was addressed by full replacement of the slurry column with fresh slurry.

Drilled shafts were excavated from a barge using the crane-mounted rotary drilling machine shown in Figure A-12. Use of a crane mount provided the clearance needed for inserting and removing the drilling tool over the top of the permanent casing. Excavated soil was discharged from the auger into barges and transported to a disposal site. Excavated soil was not permitted to be discharged into the environmentally sensitive river environment or surrounding wetlands.

The large volumes of concrete required, and the tight spacing between spiral reinforcement, made this project an excellent candidate for the use of high-performance concrete. The mix design selected corresponds closely to the description of self-consolidating concrete, or SCC, as described in Section 9.6.4.2. The most significant advantages of SCC for this project included:





Figure A-12 Crane-Mounted Drilling Machine for Construction Over Water (Photo courtesy of Paul Axtell)

- High workability and retention of workability

The volume of concrete required to construct 8-ft diameter, 192-ft long drilled shafts is approximately 360 cubic yards. This required 8 to 10 hours for placement of concrete, per drilled shaft. Retention of workability was achieved with an SCC mix design that included a high range water reducing admixture and a set retarder.

- Passing ability

The SCC mix was made with high sand content and No. 8 crushed stone, with a top-size of ½ inch. This mix provided adequate flow of concrete through the rebar cage, with a clear spacing of six times the aggregate maximum particle size.

Table A-10 presents the mix design and properties of the concrete. This mix provided slump flow in the range of 18 to 24 inches and appeared to perform very well for this job. Figure A-13 shows a typical slump flow spread. No problems were observed during tremie placement of the concrete and no anomalies were detected by cross-hole sonic logging tests. Specifications called for a minimum 4,000 psi compressive strength, but this mix had 28 day breaks as high as 7,000 psi. Other noteworthy points regarding the concrete include:

- Class F fly ash was 20% of the total cementitious material
- Sand to total aggregate ratio = 0.48
- Water to cement ratio = 0.41
- The high-range water-reducing admixture was made from polycarboxylate polymers
- The hydration control admixture (retarder) provided some water reducing benefits

**TABLE A-10 MIX DESIGN FOR DRILLED SHAFTS, DESIGN EXAMPLE**

Mix Component	Pounds/Cubic Yard	Yield (Cubic Ft)
Type I Portland Cement	526	2.68
Class F Fly Ash	132	1.00
Concrete Sand	1363	8.30
No. 8 Crushed Stone	1500	8.71
Water	267	4.28
Total Air (%)	7.5 ± 2.0	2.03
<b>Total</b>		<b>27.00</b>
<b>Admixtures</b>		<b>Ounces (US)/Cubic Yard</b>
High range water reducing and superplasticizing admixture meeting ASTM C-494 Types A and F		46.06
Water reducing and retarding admixture meeting ASTM T-494 Types B and D		26.32
Air entraining admixture meeting ASTM C-260		4.9
<b>Mix Properties</b>		
Water to Cement Ratio		0.41
Concrete Unit Weight		140.3 (lb/ft <sup>3</sup> )
Flow Spread of Fluid Concrete		19 - 24 inch



Figure A-13 Slump Flow Measurement on High-Performance Concrete of Design Example  
(Photo courtesy of Paul Axtell)

## SUMMARY

An example design problem, based on an actual bridge project, is presented to illustrate the design procedures presented in this manual. Design of single drilled shafts for one of the piers (Pier 2) is illustrated for Strength I, Service I, and Extreme Event I limit states. Information obtained from the subsurface investigation is used to establish an idealized subsurface profile and to select soil properties used in the design equations. Design scour conditions are incorporated into the Strength I and Service I limit state analyses. Calculations are presented to illustrate limit state checks for geotechnical and structural resistances, for lateral and axial loading. Finally, constructability issues relevant to the project are identified and the measures taken to address them are discussed.

Archived

This page is intentional left blank.

**APPENDIX B**

**GEOMATERIAL PROPERTIES FOR  
DRILLED SHAFTS IN SPECIFIC  
GEOLOGIC ENVIRONMENTS**

Archived

This page is intentional left blank.

## APPENDIX B

### GEOMATERIAL PROPERTIES FOR DRILLED SHAFTS IN SPECIFIC GEOLOGIC ENVIRONMENTS

Some geologic environments pose unique challenges for determination of material properties used for design of drilled shafts or for drilled shaft construction. Experience has demonstrated that these special conditions may require methods adapted to the specific geologic environment. Examples of geomaterials requiring special consideration and suggestions on how to approach characterization of their engineering properties are summarized in this appendix.

#### B.1 ARGILLACEOUS SEDIMENTARY ROCK

Fine-grained sedimentary rocks of upper Cretaceous age are encountered over wide areas of the Great Plains and include argillaceous rocks described as clay shale, claystone, siltstone, and mudstone. Locations where drilled shafts have been utilized extensively in these materials include Dallas, Texas and Denver, Colorado. Cavusoglu et al. (2004) describe the following approach to characterizing the engineering properties needed for drilled shaft design in the Eagle Ford formation, a clay shale encountered in the vicinity of Dallas. The Texas DOT cone penetration test or TCPT, described briefly in Section 3.1, is used to predict compressive strength at sites where rock coring does not provide samples sufficient for lab testing. One of the parameters measured during the TCPT test is penetration resistance ( $PR$ ), defined as the depth of penetration per 100 blows of the 170-lb drop hammer. A study was conducted in which rock strength as measured in UU triaxial compression tests was correlated to  $PR$  measurements. The authors showed reasonably good correlations between compressive strength and  $PR$ , but the correlations varied depending upon whether the clay shale exhibited carbonate cementation or not. The following correlation equations are presented:

Clay shale w/ carbonate cementation:

$$(\sigma_1 - \sigma_3)_f (ksf) = 213.16 - 5.04[PR(\text{inches})] \quad \text{B-1}$$

Uncemented clay shale w/ occasional sandstone seams:

$$(\sigma_1 - \sigma_3)_f (ksf) = 44.85 - 2.28[PR(\text{inches})] \quad \text{B-2}$$

where:  $\sigma_1$ ,  $\sigma_3$  = major and minor principal stresses at failure in a UU triaxial compression test, and  $PR$  = penetration resistance, in inches, from TCPT. The above correlations should be applied only to the Eagle Ford formation claystones, but the approach taken by the authors could be applied to other local or regional weak rock formations if transportation agencies develop empirical correlations between in-situ tests and rock compressive strength as measured in standard laboratory tests. Nominal unit side and base resistances of drilled shafts can then be evaluated using the methods for rock presented in Chapter 13.

The Colorado DOT has developed a similar approach to characterizing the engineering properties of weak rock. For example, the Denver-Arapahoe formation, commonly referred to as Denver Blue, is an upper Cretaceous unit consisting of interbedded claystone and sandstone ranging in strength from very weak to very strong. According to Abu-Hejleh et al. (2003), the standard penetration test is conducted in weak rock layers as long as the number of blows required to advance six inches is 50 or less (corresponding to  $N < 100$ ). Correlation equations were developed between the field measured N-value and drilled shaft

side and base resistances in these materials. When the number of blows to advance six inches exceeds 50, an attempt is made to use double-wall or triple-wall core barrels to obtain samples for core logging and laboratory strength testing. The laboratory strength test used by CDOT is the unconfined compression test for soil (UC). If adequate samples are not obtained, which is common when thinly bedded or highly jointed layers are encountered, pressuremeter testing (PMT) is used to estimate rock strength. The authors also developed empirical correlations between rock modulus and compressive strength. The approach can be summarized as follows:

Weak rock layers in Colorado are categorized on the basis of their lithology, blowcounts, and compressive strength:

- Category I soil-like claystone; N values < 100
- Category II very hard sandy claystone; N > 100 and  $q_u < 100$  ksf
- Category III very hard and massive shale bedrock;  $100 < q_u < 500$  ksf

For Category II and Category III materials, recovery and RQD values of core samples typically are relatively high and compressive strength of intact rock is determined from laboratory unconfined compression tests on the core specimens. For Category I materials, described as soil-like claystone, it is very difficult to collect reliable core specimens for UC testing. For these materials, the following correlation equation was developed for estimating rock compressive strength:

$$q_u \text{ (ksf)} = 0.24 N \quad \text{B-3}$$

where  $q_u$  = unconfined compressive strength and N = number of blows per foot of penetration using SPT.

The pressuremeter test (PMT) was also found to provide reliable measurements of strength and stiffness parameters, for all categories of weak rock. For Category I materials:

$$q_u \text{ (ksf)} = 0.5 (P_L - P_o)^{0.75} \quad \text{B-4}$$

and for Category II and III materials:

$$\frac{2(P_L - P_o)}{q_u} = 1 + \ln \left[ \frac{E_m}{1.33 q_u} \right] \quad \text{B-5}$$

where  $P_o$  = at-rest earth pressure and  $P_L$  = yield pressure, which corresponds to initiation of plastic deformation.

The initial modulus measured from the PMT measurements was selected by CDOT over the reload modulus to represent the modulus of the rock mass ( $E_m$ ) and to predict the load-deformation response of drilled shafts in the initial design range (service loads) where small deformations occur. Based on field load tests and laboratory tests, the following conservative correlation was derived to relate rock mass modulus to unconfined compressive strength of intact rock for design purposes:

$$E_m \text{ (ksf)} = 600 q_u^{0.5} \quad \text{B-6}$$



In summary, the CDOT approach is to use SPT N-value as the primary test for strength of Category I rocks (Equation B-3), and UC testing on intact core as the primary test for strength of massive rock masses in Categories II and III. For fractured rock mass in all three categories, PMT is recommended to characterize both stiffness and strength of weak rock mass and account for any fractures, discontinuities, and weathering. PMT was found to provide reliable and consistent results for the types of weak rock typically encountered by Colorado DOT. PMT is also recommended to supplement the strength information obtained from SPT or UC testing for all categories of weak rocks.

Using the approach to material characterization described above, the Colorado DOT has developed empirical correlations between the index and strength properties of weak rock and unit side and base resistances of drilled shafts. The correlations are based on results of 13 full-scale axial load tests. The test program and research are described in two CDOT reports (Abu-Hejleh et al. 2003; Abu-Hejleh and Atwoll 2005) and an article by Abu-Hejleh et al. (2005). Information on the construction and materials of the test shafts were documented, and an extensive program of geotechnical tests was performed at the load test sites. This included SPT, PMT, and unconfined compressive strength tests (UCT). The equations given below are reported as being applicable to drilled shafts with diameters up to 5 ft. The equations depend upon the geomaterial category, as follows.

Category I: Soil-like Claystone. In these materials it is difficult to obtain intact core specimens for lab testing and correlation equations are given for resistances (side and base) in terms of N-values.

$$f_{SN} \text{ (ksf)} = 0.075 N \quad \text{B-7}$$

$$q_{BN} \text{ (ksf)} = 0.92 N \quad \text{B-8}$$

where:  $f_{SN}$  = nominal unit side resistance,  $q_{BN}$  = nominal unit base resistance, and N = Standard Penetration Test N-value. Resistances are in units of kips per square foot (ksf). For Equations B-7 and B-8, Abu-Hejleh et al. (2003) recommend a resistance factor of  $\phi = 0.70$  based on fitting to a factor of safety of 2.0.

Category II: Very Hard Sandy Claystone.

$$f_{SN} \text{ (ksf)} = 2.05 q_u^{0.5} \quad \text{B-9}$$

where  $q_u$  = unconfined compressive strength of intact core (ksf)

$$q_{BN} \text{ (ksf)} = 1.2 [1 + L/B] q_u \quad [1 + L/B] \leq 3.4 \quad \text{B-10}$$

where L = socket length and B = socket diameter. A resistance factor of  $\phi = 0.45$  is recommended for side resistance by Equation B-9 and  $\phi = 0.50$  for base resistance by Equation B-10 (Abu-Hejleh et al. 2003).

Category III: Very hard Clayey Sandstone. Unit side resistance is calculated using Equation B-9, while unit base resistance is given by:

$$f_{SN} \text{ (ksf)} = 17 q_u^{0.51} \quad \text{B-11}$$

Abu-Hejleh et al. (2003) recommend a resistance factor of  $\phi = 0.50$  for Equation B-11.

In highly fractured rocks for all three categories, results of pressuremeter testing (PMT) can be correlated to unconfined compressive strength ( $q_u$ ) which is then used in the design equations above for side and base resistances.

Design equations are also recommended by the authors for estimating side and base load transfer curves as a function of SPT N-value for soil-like claystone and  $q_u$  for the harder claystone/sandstone (Abu-Hejleh and Atwoll, 2005). The load transfer curves can be used to make simple estimates of axial load-settlement response of drilled shafts, as described in Appendix D (see Section D.2). The qualifications and limitations for using these design methods are presented in the references cited above.

## B.2 LIMESTONE AND OTHER CARBONATE ROCKS

Geologic and engineering characteristics of carbonate rocks, including limestone and dolomite, vary widely depending upon geologic age, degree of weathering, and climate. Limestone formations range from hard and massive to weak, highly weathered, and karstic. For example, many limestone units encountered in midwestern states exhibit high compressive strengths and are relatively free of solution cavities, clay seams, and other problematic features. Limestone units in the southeastern U.S., for example in Florida, are characterized by highly variable strength profiles, the presence of cavities which may be filled with soil, and interbedding of limestone with sand and marine clay layers (Crapps, 1986). McVay et al. (1992) recommend the following expression as a reasonable estimate of ultimate unit side resistance in Florida limestone:

$$f_{su} = \frac{1}{2} \sqrt{q_u} \sqrt{q_t} \quad \text{B-12}$$

in which  $q_u$  = uniaxial compressive strength and  $q_t$  = split tensile strength (ASTM C 496). To account for the effect of material strength variability on side resistance, the authors recommend a minimum of 10 (preferably more) core samples be tested in unconfined compression and splitting tensile tests. The mean values of  $q_u$  and  $q_t$  are used in Equation B-12. The standard error of the mean from the laboratory strength tests can be used to estimate the expected variation from the mean side resistance, for a specified confidence level.

According to Lai (1998), design practice by the Florida DOT is based on a modified version of the McVay et al. relationship in which spatial variations in rock quality are incorporated by multiplying the unit side resistance, according to Equation B-12, by the average percent recovery (REC) of rock core expressed as a decimal. Lai (1998) also recommends using larger diameter double-tube core barrels (2.4-inch to 4-inch inner diameter) for obtaining samples of sufficient quality for laboratory strength tests. Analysis of the lab strength data involves discarding all data points above or below one standard deviation about the mean, then using the mean of the remaining values as input to Equation B-12.

Side resistance values in Florida limestone have also been evaluated using a small-scale field pullout test (Figure B-1). A grout plug is placed into a 5.5-inch diameter cored hole at the bottom of a 6.5-inch diameter hole drilled to the test depth in rock. Overburden soils are supported by a 8-inch diameter casing. The grout plug is reinforced with a wire cage and a threaded high-strength steel bar extends from the bottom of the plug to the ground surface. A center hole jack is used to apply a pullout force to the bar. The grout plug is typically 2 ft in length but other lengths are also used. The average unit side resistance is taken as the measured pullout force divided by the sidewall interface area of the plug.

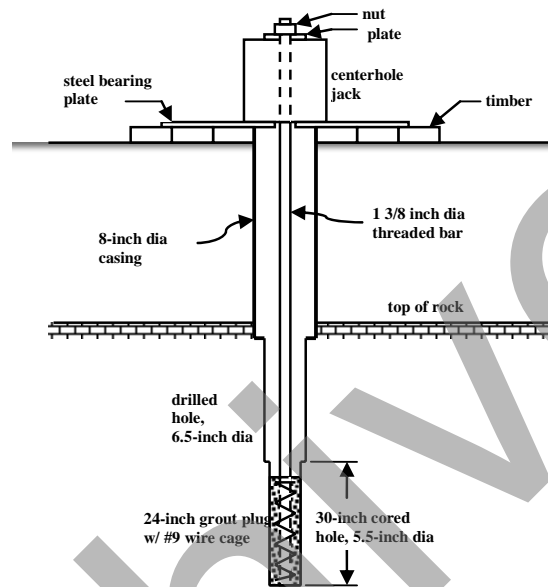


Figure B-1 Small-scale Pullout Test Used in Florida Limestone (after Crapps, 1986)

Brown (1990) describes design and construction challenges of using drilled shafts in hard pinnacled limestones and dolomites encountered in the Valley and Ridge and Cumberland Plateau physiographic provinces. Subsurface conditions are highly irregular due to extensive weathering. Although intact rock strengths may be high (up to 10,000 psi), numerous seams, slots, and cavities are typically filled with residual clayey soils (Figure B-2). In this environment of extreme variability the actual soil and rock conditions for a specific drilled shaft cannot be determined with any degree of accuracy prior to construction. Design, construction, and inspection have to be flexible enough to adjust to conditions actually encountered. Use of probe holes for downhole inspection and identification of cavities and seams along the sides and beneath the base is an essential part of the construction and inspection process (Figure B-3). To provide the flexibility needed for design, inspection, and construction, creative contracting approaches are also needed. Brown (1990) reports that contracting such work on a unit cost basis provides the flexibility needed to deal with the unknown quantities of soil versus rock drilling, concrete overpours, rock anchoring, drilling of probe holes, etc. The engineer estimates the unit quantities, but actual payment is based upon unit costs of material quantities actually used. This requires careful inspection and record keeping.

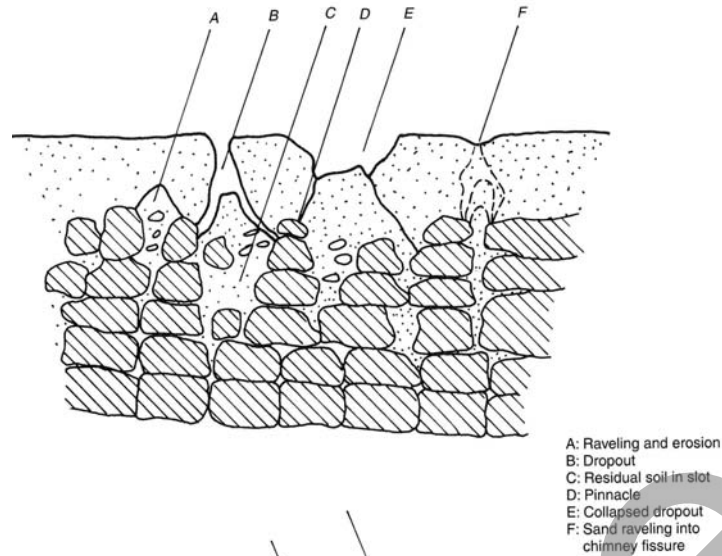


Figure B-2 Features of Karstic Terrane (Knott et al. 1993)

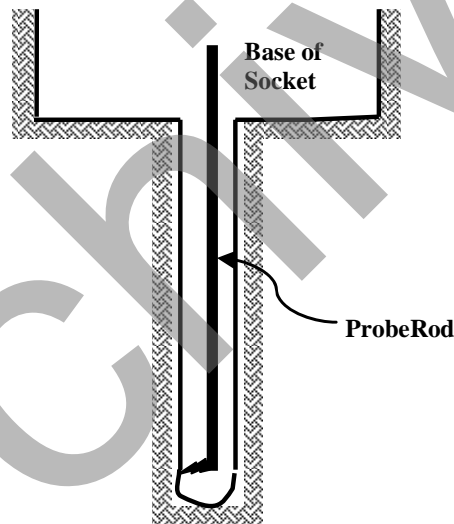


Figure B-3 Rock Probing Tool (after Brown 1990)

Geophysical profiling using multi-electrode resistivity arrays should be considered as a subsurface investigation tool in karstic limestone for its potential for identifying irregular bedrock surfaces, pinnacles, and cavities, as discussed in Chapter 2 (Figure 2-4).

### B.3 GLACIAL TILL

The term till is applied to any unstratified and unsorted sediment carried or deposited directly by glacial ice. Till may be composed of particles of all sizes from clay up to cobbles and boulders, and the type of till varies from one glacier to another as well as within a single glacial environment. "Clay tills" are

composed of predominately clay sized particles with varying amounts of sand, gravel, and larger particles, and are common in many parts of the upper Midwest, while “boulder tills” are composed for the most part of boulders and cobbles and are typical in many parts of New England. Glacial deposits can be excellent bearing units for drilled shafts because of high strength and low compressibility, but characterizing engineering properties for design and construction can be a challenge due to sampling difficulties, limitations on in-situ testing, and in some cases highly complex subsurface conditions caused by multiple periods of glacial advance and retreat, weathering profiles, and interbedding of till with other types of glacial deposits.

Soliman (1983) describes a geotechnical investigation for foundation design in a dense, heavily overconsolidated glacial till of Wisconsin age on the southern shore of Lake Ontario in Sterling, New York. The till is described as silty to very silty, gravelly, fine to coarse sand (SM) with scattered cobbles and boulders and a trace of clay. Conventional sampling methods were unsuccessful due to the high density and the high gravel and cobble content. This is a common occurrence in many till deposits and makes the use of SPT and CPT tests impractical. At the Sterling site, a double-tube Denison sampler equipped with a diamond bit and advanced by rotary drilling with downward pressure (similar to rock coring) resulted in samples adequate for laboratory testing. CD triaxial compression tests were used successfully to establish effective stress strength parameters ( $c'$  and  $\phi'$ ) for foundation design. Pressuremeter tests (PMT) were used to establish values of modulus for settlement calculations. It was observed that modulus values from PMT were 2.6 to 6 times those obtained from triaxial tests. This result is consistent with results reported by other researchers (Klohn, 1965; Radhakrishna and Klym, 1974) who also found that in-situ modulus from PMT or field plate load tests ranges from 3 to 5 times greater than modulus from triaxial tests on cored samples of hard till. These experiences suggest that coring and use of PMT are useful site characterization tools in dense overconsolidated till deposits.

Lutenegger et al. (1983) describe how Wisconsin-age glacial till deposits in Iowa can be distinguished on the basis of geologic process into two categories of *basal till* and *diamictons* and how the properties of each differ in terms of texture, density, and structure. These properties in turn can be correlated to engineering properties including shear strength and compressibility. Figure B-4 shows the relationship between density and unconfined compressive strength for basal till deposits in eastern Iowa. According to the authors, a similar correlation was demonstrated for basal tills in Denmark of similar texture (clay matrix), suggesting a universal application for basal tills of similar texture. The authors note that the Unified Soil Classification System is not useful for distinguishing between basal till and diamictons, as both materials typically are classified as CL, but that further analyses of grain size distributions show that diamictons are comprised of a wider range of particle sizes and are complexly interbedded with various types of stratified meltwater deposits. Recognizing these types of differences and understanding the geologic processes leading to formation of till deposits is key to formulating subsurface investigation strategies and understanding its engineering properties.

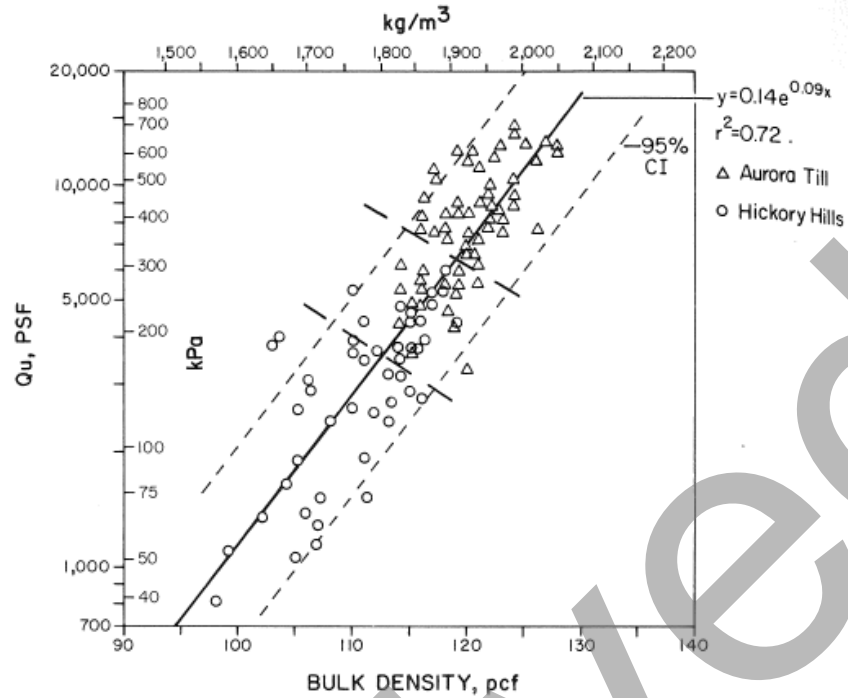


Figure B-4 Relationship Between Density and Unconfined Compressive Strength for Basal Till in Eastern Iowa (Lutenegger et al., 1983).

#### B.4 PEIDMOJNT RESIDUAL SOILS

Geotechnical aspects of Piedmont residuum are described by several authors, including Martin (1977) and Sowers and Richardson (1983). Design and construction of drilled shafts in the Piedmont are described by Schwartz (1987), Gardner (1987), Mayne and Harris (1993), and Brown (2002). Mayne and Brown (2003) found that residual soils of the southern Piedmont are not particularly well-categorized by the Unified Soil Classification System (USCS). A vertical profile in the Piedmont may appear as if alternating strata of silty sands (SM) and sandy silts (ML) form the overburden. The strata seem to change in random fashion, suggesting high variability over short distances. This apparent variability is due to the fact that the mean grain size of the Piedmont residuum is close to the 75-micron criterion that separates fine-grained from coarse-grained fractions (No. 200 sieve size). In fact, the Piedmont residuum acts more as a dual soil type (SM-ML), exhibiting characteristics of both fine-grained soils (undrained) and coarse-grained soils (drained) when subject to loading.

Mayne et al. (2000) found that interpretation by conventional analyses of in-situ tests, including SPT, CPT, and PMT, can provide reasonable predictions of effective stress friction angle ( $\phi'$ ) as measured in CU triaxial compression tests with pore pressure measurements. Use of SPT, CPT, and DMT can provide reasonable values of undrained shear strength, but users are referred to Mayne et al. (2000) for specific interpretation methods. The overall approach to estimating soil engineering properties is to obtain values of both drained and undrained strength parameters, analyze trial shaft designs for both response modes (drained and undrained), and base the final design on the critical loading mode. Calibration by laboratory tests of properties determined by in-situ tests is strongly recommended in these materials. CU triaxial tests with pore water pressure measurements offer the ability to determine strength and stress-strain properties in terms of both effective stress ( $\phi'$  with  $c' = 0$ ) and total stress ( $s_u$  with  $\phi = 0$ ).

Other factors that make drilled shafts challenging to design and build in the Piedmont are:

- highly variable depths to bedrock
- presence of cobbles and boulders
- steeply dipping bedrock surfaces
- difficulties in distinguishing between soil, partially weathered rock, and intact rock for pay purposes.

These factors make it difficult to determine the final base elevation prior to construction, for shafts required to reach intact rock. Thorough site characterization and good communication between owners, engineers, and contractors are essential for developing strategies to deal with the issues cited above. Schwartz (1987) describes the sources of cost overruns and contractor-engineer-owner conflicts commonly encountered in drilled shaft projects in the Piedmont, and presents recommendations for addressing them.

## **B.5 CEMENTED SOILS**

Cemented soils may be encountered in any location, but are widespread in the semi-arid and desert regions of the western U.S., in Florida, and along the banks of the lower Mississippi River. The effect of cementation on soil strength is to give the soil cohesion,  $c'$ , which is otherwise not present in the uncemented soil. Strongly cemented soils can be advantageous for drilled shaft design and construction by providing high resistances and often providing an opportunity for the dry method of construction (*i.e.*, eliminate the need for casing or slurry).

Cemented soils are a challenge for sampling, testing, and selection of appropriate engineering properties. If the materials are weakly cemented, the cemented structure might not be recognized when conventional soil sampling techniques are attempted. SPT blow counts may appear to be uncharacteristically high, but the recovered materials may appear to be uncemented due to destruction of the cementing bonds during drilling and sampling. Alternatively, the weak cementation may be sufficient to preclude sampling using Shelby tubes. In both of these cases, the driving/pushing resistance may be mistakenly interpreted as being characteristic of dense uncemented sands. At the other extreme, strongly cemented soils may exhibit refusal when sampling with conventional soil sampling methods, requiring specialized samplers suitable for hard soil (Pitcher barrel or Dennison samplers) or rock coring.

Techniques to correctly identify cemented materials in borings include: (1) carefully observe the recovered cuttings and attempt to recover small pieces of the cemented materials that are returned with the uncemented material; and (2) be observant of the potential reasons for “anomalous” behavior during drilling and sampling (*e.g.*, uncharacteristically high blow counts during soil sampling, poor core recovery despite relatively uniform moderate drilling resistance, etc.). Observation of cemented soils in nearby roadcuts or other surface exposures may suggest the presence of cemented deposits in the subsurface.

Caliche is a cemented geomaterial commonly encountered in the semi-arid and desert lands of the western U.S. While the term is loosely applied to any cemented soils, true caliche is considered to be the hard lithification of both fine-grained sediments and sand and gravel through secondary cementation by calcium and magnesium carbonate. Table B-1 summarizes the nomenclature and drilling characteristics of caliche in the Las Vegas, NV area, where these deposits are widespread and important bearing units for

both shallow and deep foundations (Cibor, 1983). The descriptions in Table B-1 illustrate the wide variety of material characteristics of cemented soils and suggests approaches for categorizing cemented soils and sampling strategies based on the categorization.

There is no specific standardized approach for establishing the strength or deformation characteristics of cemented soils due to the wide variation in properties and behavior of these materials. A common sense approach can be outlined, as follows.

Useful index tests on cemented soils include a simple unit weight determination on an undisturbed specimen, which can help to determine whether the material is as dense as the high blowcount response would indicate. It may be possible to either immerse a sample in water or simply add water to a piece of the intact sample to assess whether the cementing agent is soluble or if the material softens when inundated with water. If either of these responses is identified, a careful assessment must be made of whether the service conditions will result in the introduction of (and the effect of) water. If so, the strength of the soil should be evaluated for the uncemented state.

**TABLE B-1 EXAMPLE CLASSIFICATION AND DRILLING/SAMPLING CHARACTERISTICS OF CALICHE, LAS VEGAS VALLEY (AFTER CIBOR, 1983)**

Nomenclature		Hardness Classification	Drilling Rates <sup>(1)</sup> minutes/ft		Description of Material and Drill Cuttings
Cemented coarse-grained deposits	Cemented fine-grained deposits		Without pull-down	With pull-down	
Sand and gravel with scattered cementation	Decomposed caliche with silt and clay	Very stiff/very dense to slightly hard	-	-	Variable matrix of uncemented soil and cemented zones. Samples obtained with split-spoon or thick-walled sampler. Can be crumbled with fingers.
Partially cemented sand and gravel	Decomposed caliche	Moderately hard	< 5	< 3	Cemented to varying degrees. Fine-grained deposits sampled with thick-walled sampler; coarse-grained samples cannot be obtained with thick-walled sampler. Drilling produces large, rounded cuttings. Cuttings can be broken with difficulty with hands or easily when hammered.
Cemented sand and gravel	Weathered caliche	Hard	6 to 30	3 to 6	Visible chemical alterations from fresh deposits. Compressive strength similar to fresh deposits. Slight secondary porosity. Samples obtained by coring techniques. Drill cuttings less than 1/2 inch in diameter. Fragments can be broken with difficulty by hammering
	Fresh caliche	Very hard	700	70	No visible signs of chemical alteration. Non-porous. Resembles metamorphic or sedimentary rock. Drill cuttings less than 1/8 inch in diameter. Samples obtained by coring techniques. Fragments cannot be broken by hammering.

<sup>(1)</sup> using Mayhew 100 drill rig



Strongly cemented soils, for example the caliche materials described as hard and very hard in Table B-1 that can be sampled using coring techniques, can be treated as sedimentary rock for the purpose of foundation design. Uniaxial (unconfined) compressive strength should be measured in laboratory tests and design equations for nominal resistances given for rock can be applied to drilled shaft design. Recent bi-directional load cell tests on drilled shafts in Las Vegas showed unit side resistances in the range of 30 to 55 kips per square foot (ksf) in competent caliche layers, compared to 8 to 22 ksf in dense sand and gravel (uncemented), and 4 ksf in stiff clay layers (Gura et al., 2007). No data are reported on measured strength of the caliche, but Cibor (1983) reports a range of 576 ksf to 1,440 ksf (4,000 to 10,000 psi) for compressive strength of competent caliche in the Las Vegas Valley, suggesting that methods presented in Chapter 13 for side resistance in rock apply to competent caliche. This hypothesis warrants further research.

For less cemented soils not exhibiting characteristics of rock, the following additional guidance based on GEC No. 5 (Sabatini et al., 2002) is provided. If specific strength/deformation characteristics are needed, laboratory triaxial shear or direct shear testing is recommended. Because of the sensitive and brittle nature of the cementing materials, these tests must be carefully conducted and interpreted. It is important that representative samples be selected for laboratory testing, because one of the effects of sample disturbance is that only the strongest materials may survive the drilling/sampling process. Block sampling has been shown to be an effective technique for obtaining samples of cemented sands suitable for laboratory testing. In-situ testing using a pressuremeter has also been used effectively to provide quantitative strength and stiffness information. Other in-situ testing techniques, specifically the SPT and dilatometer (DMT), provide useful qualitative results, but must be calibrated to specific site/material conditions to provide quantitative information.

The load versus deformation response of cemented sands must also be reviewed from the perspective of the brittle character of the material. At low confining pressures, the response due to cementation will dominate the frictional response. This results in an initial stiff response due to the cementation, followed by a strain softening response associated with the frictional characteristics of the sand after rupture of the cementing bonds. As the confining pressure increases for a specific degree of cementation, the difference between the peak and post-peak strengths decreases. At high confining pressures, it is possible that application of the confining pressure may result in disruption of cementing bonds, resulting in a load-deformation response that is consistent with that of an uncemented sand. The lesson from this general response characteristic is that the range of test confining pressures must be carefully selected to match the anticipated service conditions. Additionally, because the cementing bonds can be disrupted at low strains, the anticipated strains under the anticipated working stress should be assessed to allow the engineer to decide whether the peak (*i.e.*, cemented) or the large-displacement (*i.e.*, uncemented) strengths should be used in design.

## **B.6 SUMMARY**

The examples cited above represent geomaterials for which the drilled shaft engineering community has developed at least some level of experience. The list is by no means exhaustive and geotechnical engineers should always be attentive to materials that exhibit unusual behaviors due to their geologic origin, composition, or other factors not accounted for by conventional characterization methods. Unusual behavior might include discrepancies between in-situ test results and expected behavior based on index properties, difficulty in obtaining representative samples, extremely high spatial variability in subsurface conditions, and expansive or collapsing behavior. For drilled shafts constructed in these geologic environments, or under any conditions that make it difficult to establish engineering properties of the supporting geomaterials, load testing and construction of technique shafts during the design phase should be considered. In most cases, the information obtained from technique shafts and design-phase

load tests will yield more reliable design parameters and reduced risks of construction claims for differing site conditions and quantity overruns. It must be noted that load testing does not necessarily reduce foundations costs. Load testing may produce lower foundation resistance values than anticipated, potentially increasing foundation size and cost. Load test data from other nearby projects should also be utilized, whenever possible. If subsurface conditions can be shown to be similar, existing data can provide confidence in design parameters without the expense of a design-phase testing program.

Archived

## **APPENDIX C**

# **COMMENTARY ON METHODS FOR COMPUTING NOMINAL AXIAL RESISTANCE OF DRILLED SHAFTS**

Archived

This page is intentional left blank.

**APPENDIX C**  
**COMMENTARY ON METHODS FOR COMPUTING NOMINAL AXIAL RESISTANCE OF DRILLED SHAFTS**

**C.1 SIDE RESISTANCE IN COHESIONLESS GEOMATERIALS**

In Chapter 13, the nominal side resistance of a drilled shaft in cohesionless soil is modeled as the frictional resistance that can be developed over a cylindrical surface at the soil-shaft interface, given by:

$$R_{SN} = \pi B \Delta z f_{SN} = \pi B \Delta z (\sigma'_h \tan \delta) \quad \text{C-1}$$

in which  $R_{SN}$  = nominal side resistance,  $B$  = shaft diameter,  $\Delta z$  = thickness of the soil layer over which resistance is calculated, and  $f_{SN}$  = nominal unit shearing resistance,  $\sigma'_h$  = horizontal effective stress, and  $\delta$  = effective stress angle of friction for the soil-shaft interface. Figure C-1 depicts a segment of drilled shaft and the resulting unit shearing resistance developed along the interface. The horizontal effective stress acts as a normal stress at the interface, and  $\tan \delta$  is equivalent to a sliding coefficient of friction. Horizontal effective stress is expressed in terms of vertical effective stress ( $\sigma'_v$ ) and the coefficient of horizontal soil stress ( $K = \sigma'_h / \sigma'_v$ ), resulting in the following expression:

$$R_{SN} = \pi B \Delta z (\sigma'_v K \tan \delta) \quad \text{C-2}$$

The last two terms in Equation C-2 often are grouped as follows:

$$\beta = K \tan \delta \quad \text{C-3}$$

and

$$f_{SN} = \sigma'_v \beta \quad \text{C-4}$$

in which  $\beta$  = side resistance coefficient and  $f_{SN}$  = nominal unit side resistance. In terms of the coefficient  $\beta$ , total side resistance for a cohesionless soil layer is then given by:

$$R_{SN} = \pi B \Delta z (\beta \sigma'_v) \quad \text{C-5}$$

Two approaches for evaluating the coefficient  $\beta$  have been used in U.S. practice. In one approach, trends of  $\beta$  versus depth ( $z$ ) determined from field load tests are used to develop empirical relationships between  $\beta$  and  $z$ . O'Neill and Hassan (1994) refer to this as the "depth-dependent  $\beta$  method" and this is the basis of the equations given in the previous version of this manual (O'Neill and Reese, 1999) as well as the current AASHTO LRFD Bridge Design Specifications (2007). A more fundamental approach is to evaluate  $\beta$  in terms of  $K$  and  $\delta$ . Each approach is reviewed, followed by a discussion on the relative merits of each.

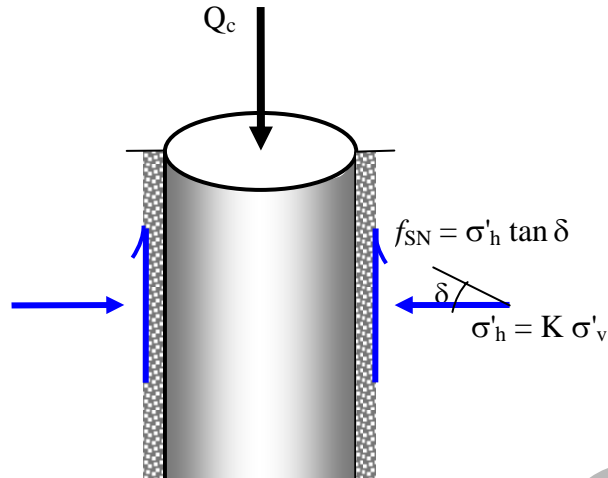


Figure C-1 Frictional Shear Model of Drilled Shaft Side Resistance in Cohesionless Soil

The depth-dependent  $\beta$  method is given by the following expressions:

For sandy soils:

$$\beta = 1.5 - 0.135\sqrt{z} \quad \text{for } N_{60} \geq 15 \quad 0.25 \leq \beta \leq 1.2 \quad \text{C-6}$$

For gravelly sands and gravels:

$$\beta = 2.0 - 0.06(z)^{0.75} \quad \text{for } N_{60} \geq 15 \quad 0.25 \leq \beta \leq 1.8 \quad \text{C-7}$$

For all cohesionless soils:

$$\beta = \frac{N_{60}}{15} (1.5 - 0.135\sqrt{z}) \quad \text{for } N_{60} < 15 \quad \text{C-8}$$

Unit side resistance calculated by the above expressions is limited to an upper bound value of 4,000 psf unless higher values are shown to be valid by load tests. This value is not a theoretical limit, but was reported to be the largest value measured when Equation C-6 was first proposed by O'Neill and Reese (1978). In the AASHTO (2007) LRFD specifications a resistance factor of 0.55 is adopted for use with the above expressions for  $\beta$ , based on the recommendation of Allen (2005).

Rollins et al. (2005) proposed the following modified form of the depth-dependent  $\beta$  method for gravels (> 50 percent gravel size)

$$\beta = 3.4 \times e^{(-0.085z)} \quad 0.25 \leq \beta \leq 3.0 \quad \text{C-9}$$

Rollins et al. note that almost all of the gravels in the database used to establish Equation C-9 exhibited N-values greater than 25, with values up to 100. According to the authors, Equation C-9 therefore is not applicable to low blow count gravels but would apply to gravels with  $N_{60} > 50$ .

Equations C-6 through C-9 are used to assign nominal values to the coefficient  $\beta$  solely as a function of depth ( $z$ ). A basic premise of the depth-dependent approach, as described by O'Neill and Hassan (1994), is that drilled shaft construction disturbs the soil, reducing its density and allowing relaxation of horizontal stress. It is further assumed that disturbance can reduce the soil friction angle to a lower-bound value corresponding to the critical state void ratio (O'Neill and Reese, 1988 and 1999). Based on this reasoning, detailed evaluations of in-situ strength and state of stress are not warranted because the in-situ properties are changed by construction and the changes cannot be predicted reliably, in particular if the designer does not know ahead of time what construction methods will be used. Instead, near lower-bound values of  $\beta$  back-calculated from field load tests are assumed to provide a conservative approximation of unit side resistance. Using this model, the nominal value of  $\beta$  in a cohesionless soil layer with  $N_{60} = 15$  is assumed to have the same value of  $\beta$  as a cohesionless soil layer at the same depth but with  $N_{60} = 50$ .

The load test results used by O'Neill and Hassan (1994) to develop Equations C-6 through C-8 are shown in Figure C-2 as back-calculated values of  $\beta$  versus depth. The trend line labeled "Improved lower-bound design relation  $N > 15$ " corresponds to Equation C-6. For a full discussion of the data and trend lines shown in Figure C-2 the reader should consult O'Neill and Hassan (1994). It can be observed that  $\beta$  exhibits a wide range of values at shallow depths, and there is a general trend of decreasing  $\beta$  with increasing depth. This trend, which is reflected in Equations C-6 through C-9, can be attributed to higher values of  $K$  near the surface, where many soil deposits are overconsolidated. Overconsolidation occurs in response to mechanical processes (burial and subsequent erosion) but also from fluctuations in the water table, capillary rise, desiccation, and aging. The effect of preconsolidation is to increase the in-situ horizontal stress and, therefore,  $\beta$ . With increasing depth, most soil deposits trend toward a normally consolidated state, a lower value of  $K$ , and therefore a lower value of  $\beta$ . From Equation C-6,  $\beta$  is assumed to reach a constant minimum value of 0.25 below a depth of 85 ft, corresponding approximately to a normally consolidated value of  $K$  for a friction angle of 22 degrees. While the depth-dependent  $\beta$  method has been found to provide conservative estimates of nominal side resistance for most soil profiles, its failure to account explicitly for the in-situ state of stress and the soil shear strength imposes a limitation on designers to model properly the mechanisms of soil-structure interaction that control side resistance.

The more fundamental approach, as presented for example by Kulhawy (1991), Mayne and Harris (1993), Chen and Kulhawy (2002), Kulhawy and Chen (2007), and others, is to evaluate separately the parameters that are lumped into the coefficient  $\beta$ . From Equation C-3, these are the interface friction angle ( $\delta$ ) and the coefficient of horizontal soil stress ( $K$ ). For concrete cast in place against soil, as in a drilled shaft, the interface is assumed to be rough and  $\delta$  can be taken equal to the effective stress friction angle of the soil:

$$\delta \approx \phi' \quad \text{C-10}$$

The value of soil friction angle can be determined through correlation to common in-situ tests such as SPT N-values or CPT cone resistance as presented in Chapter 3. When SPT results are available, the recommended correlation for sands and gravels is:

$$\phi' = 27.5 + 9.2 \log[(N_1)_{60}] \quad \text{C-11}$$

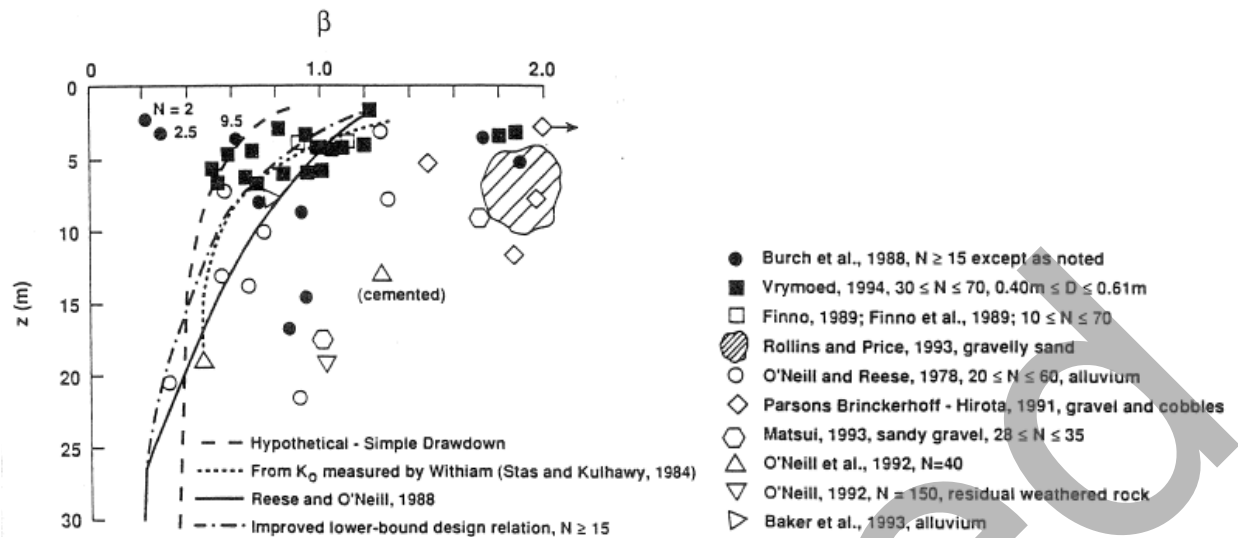


Figure C-2 Variations of  $\beta$  with Depth (O'Neill and Hassan, 1994)

The value of  $K$ , coefficient of horizontal stress, is a function of the in-situ (at-rest) value,  $K_0$ , and changes in horizontal stress that occur in response to drilled shaft construction, which can be expressed in terms of the ratio  $K/K_0$ . In this approach, the coefficient beta can be expressed as:

$$\beta = K_0 \left( \frac{K}{K_0} \right) \tan \phi' \quad \text{C-12}$$

To apply this approach it is necessary to select values of  $K_0$  and construction-related changes in terms of  $K/K_0$ . As described by Chen and Kulhawy (2002), early studies suggested that  $K/K_0$  be taken as 1 for dry construction, 5/6 for casing construction, 2/3 for slurry construction, and 11/12 for combined dry/casing construction. However, back-analyses of field load tests using the approach described herein by Chen and Kulhawy (2002) suggest these values are overly conservative and that  $K/K_0$  is close to 1 for properly constructed shafts. As a first-order approximation it will be assumed that  $K/K_0 = 1$ , and therefore the operative value of  $K$  equals the in-situ value  $K_0$ . For simple virgin loading-unloading of “normal soils” that are not cemented, the  $K_0$  value increases with overconsolidation ratio (OCR) according to (Kulhawy and Mayne, 1982):

$$K_0 = (1 - \sin \phi') \text{OCR}^{\sin \phi'} \leq K_p \quad \text{C-13}$$

$$\text{OCR} = \frac{\sigma'_p}{\sigma'_v} \quad \text{C-14}$$

where  $\sigma'_p$  = effective vertical preconsolidation stress. In Equation C-13,  $K_0$  is limited to an upper bound value equal to the Rankine coefficient of passive earth pressure,  $K_p$ . A variety of methods have been proposed for evaluation of either  $K_0$  or  $\sigma'_p$  by correlations with in-situ test measurements. For a practical



estimate based on the most commonly used in-situ test (SPT) the following correlation is suggested by Mayne (2007):

$$\frac{\sigma'_p}{p_a} \approx 0.47 (N_{60})^m \quad \text{C-15}$$

where  $m = 0.6$  for clean quartzitic sands and  $m = 0.8$  for silty sands to sandy silts (*e.g.*, Piedmont residual soils). Kulhawy and Chen (2007) suggest the following correlation provides a good fit for gravelly soils:

$$\frac{\sigma'_p}{p_a} = 0.15 N_{60} \quad \text{C-16}$$

Substituting Equations C-12 through C-15 into Equation C-11 leads to the following approximation of  $\beta$  for cohesionless soils:

$$\beta \approx (1 - \sin \phi') \left( \frac{\sigma'_p}{\sigma'_v} \right)^{\sin \phi'} \tan \phi' \leq K_p \tan \phi' \quad \text{C-17}$$

where  $\sigma'_p$  is estimated by Equation C-15 for sandy soils and by Equation C-16 for gravelly soils. The calculated value of  $\beta$  is substituted into Equation C-5 for determination of nominal side resistance  $R_{SN}$ . The advantage of this approach is that it allows the designer to account for site-specific variations in horizontal stress and soil strength in a rational manner. The principal limitation to this approach is that in-situ stress and soil strength are determined through correlation to N-values, and therefore are subjected to all sources of error and variability associated with the SPT. Furthermore, this method, in terms of the equations presented above, has not been evaluated for calibration of resistance factors using the procedures required for incorporation into the AASHTO LRFD specifications. However, a simple calibration to allowable stress design (historical practice), assuming a factor of safety = 2.0, yields a resistance factor of 0.45. This value is recommended until additional calibration studies are conducted.

The database used by Chen and Kulhawy (2002) included 100 axial load tests on drilled shafts at 53 sites. Figure C-3 shows the back-calculated values of  $\beta$  versus depth for all 100 tests. The general trend is similar to Figure C-2, showing high values of  $\beta$  and large scatter at shallow depths and decreasing values of  $\beta$  and less scatter with increasing depth, converging to the normally consolidated range at depths greater than 100 ft (30 meters) or so. Both uplift (54 tests) and compression (46 tests) are included. The results demonstrate that  $\beta$  values are essentially the same for uplift and compression, varying by less than 4 percent. Test shaft depths ranged from 4.5 ft to 200 ft and diameters ranged from less than 1 ft to 6.5 ft. The range of depth to diameter ratios ( $L/B$ ) is 2.5 to 56.4. Soil types at the test sites are dominated by sands and range from gravelly sand to sand to silty sand. A few cemented sand sites are included.

All load test results were evaluated in a consistent manner to establish nominal resistances using the  $L_1$ - $L_2$  interpretation described by Hirany and Kulhawy (1989, 2002). The basic concept is depicted graphically in terms of a normalized load versus normalized displacement curve as shown in Figure C-4. The elastic limit is defined at  $L_1$ , and occurs on average at a normalized displacement of  $\approx 0.4\%$ . This is followed by a nonlinear yield region. The end of this region is denoted by  $L_2$ , the interpreted failure load, which is defined as the point where a final linear region begins. On average, data from compression load tests show that the point  $L_2$  occurs at a normalized displacement of  $\approx 4\%$  (as shown in Figure C-4). For uplift,

$L_2$  occurs at an average value of absolute displacement of 0.5 inch. For each compression load test, nominal resistance was established graphically by the load at 4% normalized displacement. For uplift tests, nominal resistance was taken as the load at 0.5 inch upward displacement. According to its authors, attributes of the  $L_1$ - $L_2$  interpretation for drilled shafts are: independence of scale and individual judgment; does not involve extrapolation of the measured load-displacement curve; accounts for foundation diameter; and considers the shape of the load-displacement curve. Further background on this method, is given in the two references cited above.

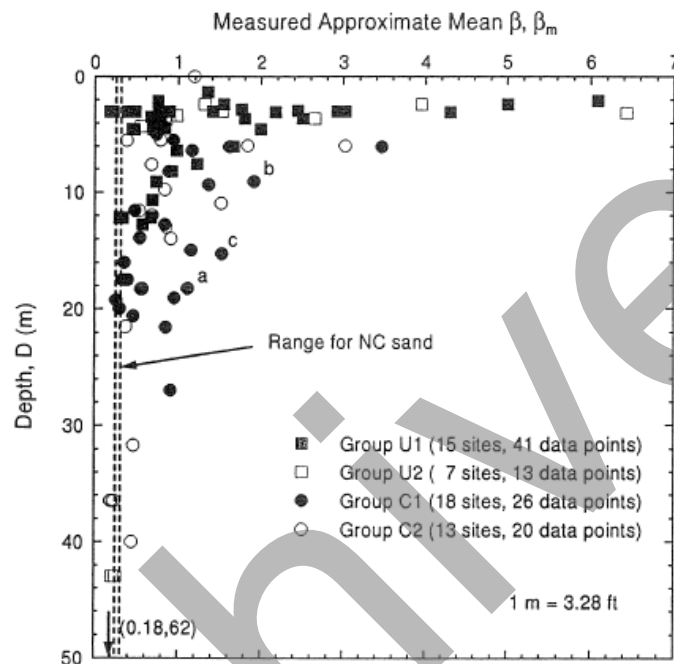


Figure C-3 Variation of Measured  $\beta$  with Depth (Chen and Kulhawy, 2002)

Of the 100 load tests considered by Chen and Kulhawy (2002), 58 tests were accompanied by data that were deemed sufficient to make predictions of  $\beta$  on the basis of soil properties. At the majority of sites, soil properties were characterized by correlations with SPT N-values. An updated analysis of the 2002 data, with additional data from load tests on shafts in gravel and cobbles, is given by Kulhawy and Chen (2007). For each test accompanied by suitable information on soil properties, the coefficient  $\beta$  was predicted using Equation C-12 and  $\phi'$  was evaluated by Equation C-11. The soil profile along the shaft was divided into several layers and average  $K_o$  and  $\phi'$  values were evaluated at the mid-depth of each layer. These were used to calculate a  $\beta$  value for each layer and then weighted averages were used to calculate an average  $\beta$  over the length of the shaft. Figure C-5 shows a comparison between the ratio of values of  $\beta$  from load test measurements ( $\beta_m$ ) to the predicted values ( $\beta_p$ ) versus normalized depth (depth/diameter). Analyses of these data give a mean  $\beta_m/\beta_p = 1.16$ . These results suggest that the analysis model yields predictions of side resistance to a level of accuracy and reliability that is acceptable for geotechnical practice. Furthermore, the results are consistent over a range of cohesionless soil profiles including sand, gravel, and cobbles, provided the soil parameters are evaluated properly.

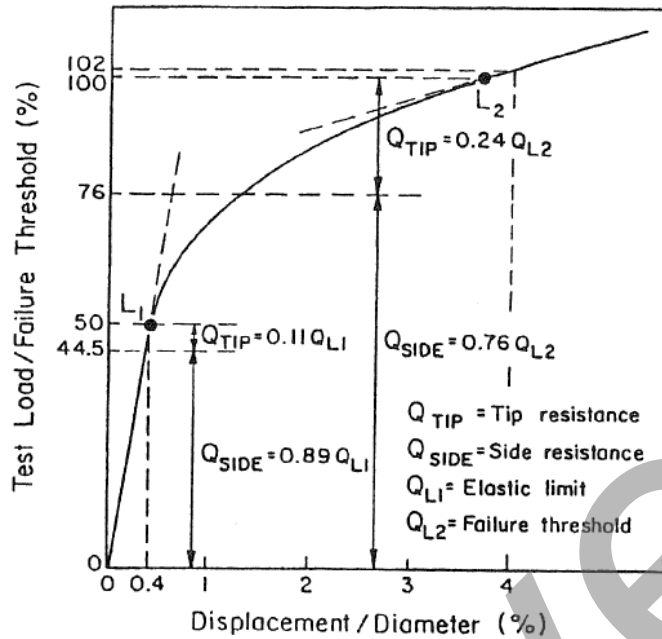
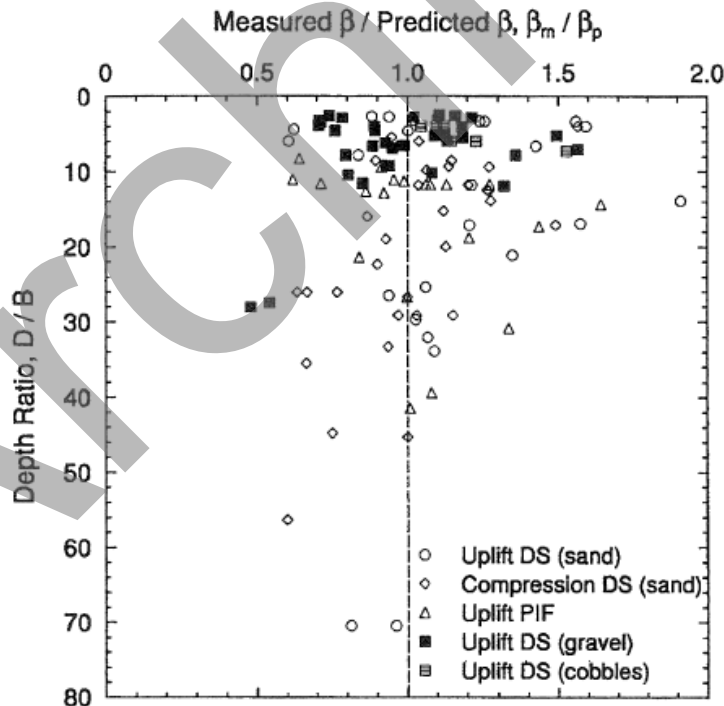


Figure C-4 Average Normalized Load-displacement Curve that Forms the Basis of Load Test Interpretation for Compression (Chen and Kulhawy, 2002).



Note: DS = drilled shaft foundations; PIF = pressure injected footings

Figure C-5 Ratio of Measured to Predicted  $\beta$  Values Versus Depth Ratio for Drilled Foundations in Cohesionless Soils (Kulhawy and Chen, 2007)

The approach described above is adaptable to other in-situ methods that allow measurement of horizontal soil stress and its variation with depth, such as pressuremeter test (PMT) and flate plate dilatometer test (DMT). The measured horizontal effective stress is then used directly in Equation C-1 to evaluate nominal side resistance. When cone penetration test (CPT) results are available, the following expression given by Mayne (2007) provides a direct estimate of OCR from measured cone tip resistance values:

$$\text{OCR} = \left[ \frac{0.192 \left( \frac{q_t}{p_a} \right)^{0.22}}{(1 - \sin \phi') \left( \frac{\sigma'_v}{p_a} \right)^{0.31}} \right]^{\left( \frac{1}{\sin \phi' - 0.27} \right)}$$

C-18

in which  $q_t$  = cone tip resistance,  $\sigma'_v$  = vertical effective stress, and  $p_a$  = atmospheric pressure in the same units as  $q_t$  and  $\sigma'_v$ . The OCR value is then substituted into Equation C-13 for an estimate of  $K$ , which is used to evaluate  $\beta$  and nominal side resistance. Equation C-18 was derived empirically from statistical evaluations on 26 different series of CPT calibration chamber tests. Cohesionless soils used in the tests were primarily quartz and feldspar sands with OCR values ranging from 1 to 15.

In Equation C-17, it is assumed that no change in horizontal stress, and therefore no change in  $K$ , occurs as a result of construction. Analysis of load test data demonstrates this assumption is valid for dry, slurry (wet-hole), and casing methods of construction with minimal sidewall disturbance, proper handling of slurry and casing, and prompt placement of concrete (Chen and Kulhawy, 2002). However, when these aspects of construction quality are not controlled properly, the coefficient  $K$  can be reduced to 2/3 of its initial in-situ value ( $K_o$ ). Judgment and accurate knowledge of field realities are therefore needed to assess the applicability of the design equations to individual projects. The recommended approach is to take the necessary measures that will assure the highest quality of construction, thereby justifying the use of the design equations presented above. When there is reason to believe quality construction cannot be achieved, the drilled shaft designer has the option to apply reduced values of  $K$  and/or  $\phi'$  for computing side resistance.

## **Discussion**

The recommendation given herein to adopt the  $\beta$ -method with separate evaluation of  $K$  and  $\delta$  (rational method), versus the depth-dependent  $\beta$ -method, represents a departure from previous FHWA practice and current AASHTO specifications (2007). Justification for these revisions is based on both theoretical and empirical arguments. First, it was recognized very early that a frictional shear model of side resistance, as expressed by Equation C-2, provides the proper effective stress analysis for side resistance of deep foundations in cohesionless materials. For example, see Tomlinson (1963), Vesic (1977), O'Neill and Reese (1978), Kulhawy et al. (1983), or Turner and Kulhawy (1990). However, a lack of data from load tests on drilled shafts in cohesionless soils limited the development and verification of specific methods for proper assessment of the parameters  $K$  and  $\tan \delta$  needed to apply this model to drilled shaft design. The depth-dependent  $\beta$  method was introduced by O'Neill and Reese (1978) as an interim, empirical approach that would provide conservative estimates of side resistance given the uncertainties associated with construction effects and the limited data available at the time. The database of load tests against which the depth-dependent  $\beta$  values were evaluated consisted of only two load tests in sand and 18 tests in "mixed" soil profiles of sand and clay (Reese and O'Neill, 1988). Since that time, a significant amount of additional information available from load tests has made it possible to move beyond depth-dependent empirical equations for  $\beta$  and into the realm of methods based on the correct theoretical model. The

resulting research published over the past 20 years demonstrates the validity of applying an analysis model that incorporates careful geotechnical evaluation of the soil parameters that determine side resistance as expressed by Equation C-2. This research has consisted of careful studies involving analysis of data from full-scale load tests and also through development of improved correlations between in-situ tests, in particular SPT and CPT measurements, and horizontal stress in soils. The reader is referred to the following references that present research supporting this approach: Kulhawy (1991), Mayne and Harris (1993), O'Neill and Hassan (1994), Chen and Kulhawy (2002), and Kulhawy and Chen (2007).

The practice of lumping  $K$  and  $\delta$  into a single parameter ( $\beta$ ) and then evaluating  $\beta$  solely as a function of depth neglects the influence of geology, material type, and stress history. Use of this method restricts the ability of a foundation engineer to design a drilled shaft on the basis of site-specific ground conditions. While this approach may have been warranted in the past as a result of construction-related uncertainties and insufficient data, compelling evidence now exists to demonstrate that these factors can be taken into account in engineering practice. As stated by O'Neill and Hassan (1994), the rational method is “clearly superior to the depth dependent  $\beta$  method from a soil mechanics perspective” and “should give more accurate values for  $\beta$ ” than the depth-dependent  $\beta$  method.

A further important reason for adopting the rational  $\beta$ -method is that the previous version of this manual (O'Neill and Reese, 1999) adopted this approach for cohesionless materials with  $N_{60} > 50$  (cohesionless IGM). This created a discrepancy between the design equations recommended for shafts in cohesionless soils and the method for cohesionless IGM. Adoption of a single approach therefore provides a unified design model for all cohesionless geomaterials.

For strictly illustrative purposes (not for design), Figure C-6 shows curves of  $\beta$  versus depth as calculated for three cases: rational method with  $N_{60} = 15$ , rational method with  $N_{60} = 50$ , and the depth-dependent beta method for sand with  $N_{60} \geq 15$  (Equation C-6). For the rational method,  $\beta$  at shallow depths is limited to the value corresponding to a depth of 7.5 ft, which corresponds approximately to a vertical effective stress of  $\approx 900$  psf. At lower confining stress, the correlations for effective stress friction angle and preconsolidation stress have not been validated and it would be prudent to limit  $\beta$  to the values corresponding to this depth. The unit weight used to calculate  $\beta$  values in Figure C-6 is assumed to be 120 pcf and constant with depth, and no water table effects are considered. The figure serves to illustrate the restriction imposed by the depth-dependent method (dashed line) on a designer's ability to assign nominal values of side resistance to cohesionless soil layers. For soils with relatively high N-values and quality construction, overly conservative estimates of side resistance will result, diminishing the cost advantages of drilled shaft foundations. The rational method correctly provides the designer with a tool to assign higher values of side resistance to layers exhibiting higher N-values, and lower nominal side resistance values to layers exhibiting lower N-values. This approach leads to designs that are both more cost-effective and more reliable by accounting for site-specific ground conditions. The curves for  $\beta$  within the range of  $15 \leq N_{60} \leq 50$  also provide a much improved match to the distribution of  $\beta$  versus depth as illustrated in Figure C-2 and Figure C-3.

Application of the rational approach for evaluation of nominal side resistance in cohesionless soils can be summarized by the following steps. For each cohesionless geomaterial layer:

- Establish mean value of  $N_{60}$  and mean vertical effective stress  $\sigma'_v$
- Establish  $\phi'$  by correlation to  $N_{60}$  and  $\sigma'_v$
- Establish  $\sigma'_p$  by correlation to  $N_{60}$  by Equation C-15 if sand; by Equation C-16 if gravel
- Calculate  $K_o$  using estimated values of  $\sigma'_p$ ,  $\phi'$ , and  $\sigma'_v$  (Equation C-13)
- Calculate  $\beta$  by Equation C-17 and average nominal unit side resistance  $f_{SN}$  by Equation C-4
- Calculate nominal side resistance  $R_{SN}$  by Equation C-1

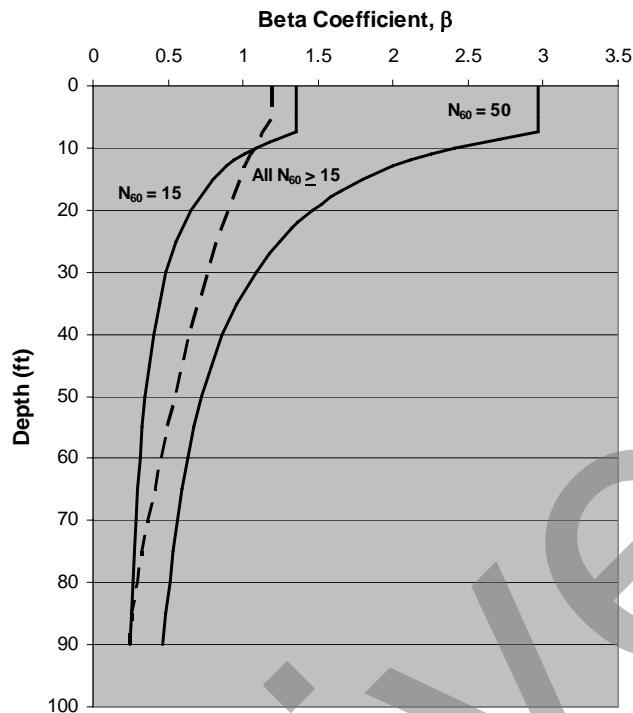


Figure C-6 Comparison of  $\beta$  Values Computed by Rational Method and Depth-Dependent Method

## C.2 BASE RESISTANCE BY BEARING CAPACITY ANALYSIS

Bearing capacity theory provides a theoretical framework for evaluating the base (tip) resistance of deep foundations in soil and rock. The degree to which bearing capacity analyses are applicable depends upon the extent to which the assumed base conditions correspond to actual field realities. Experience and observations from load tests suggest that bearing capacity theory provides reliable estimates of base resistance for shafts bearing on cohesive soils. The method recommended in Chapter 13 for nominal base resistance of shafts in cohesive soils (Equation 13-18) is based on bearing capacity analysis. For shafts bearing on cohesionless soils, experience shows that full mobilization of the theoretical bearing capacity generally requires downward displacements that average approximately 10 percent of base diameter. Load test results also show higher variability in base resistance in cohesionless soils, possibly due to disturbance of the soil caused by stress release, seepage, and drilling. Nevertheless, when the base load-displacement behavior is accounted for properly, bearing capacity theory provides a useful tool for evaluating drilled shaft strength and service limit states. In this Appendix, bearing capacity equations applicable to drilled shafts in cohesionless and cohesive soils are presented in greater detail than in Chapter 13, along with recommendations for evaluating the various parameters.

Bearing capacity equations have not been applied widely to the design of drilled shafts in rock. The empirical approach presented in Chapter 13, based on strength of intact rock, is recommended for routine applications. However, recent advancements in characterization of rock mass strength, for example use of Geological Strength Index (GSI) for fractured rock mass, make it possible to formulate analytical expressions for base resistance from bearing capacity theory. Future improvements in base resistance predictions are likely when considered within the framework of bearing capacity theory, as described herein.

Nominal base resistance is the product of the nominal unit base resistance ( $q_{BN}$ ) and the cross-sectional area of the shaft base ( $A_{base}$ ), or:

$$R_{BN} = q_{BN} A_{base} = \frac{\pi B^2}{4} q_{BN} \quad C-19$$

When bearing capacity theory is applied, the nominal unit base resistance is taken as the ultimate bearing capacity ( $q_{ult}$ ) of the soil or rock beneath the shaft base. The general form of the solution to the bearing capacity equation is given by:

$$q_{ult} = cN_c \zeta_{cs} \zeta_{cd} \zeta_{cr} + 0.5 B \gamma N_\gamma \zeta_{\gamma s} \zeta_{\gamma d} \zeta_{\gamma r} + qN_q \zeta_{qs} \zeta_{qd} \zeta_{qr} \quad C-20$$

in which  $c$  = soil cohesion,  $\gamma$  = soil unit weight,  $q$  = vertical stress at the shaft base elevation ( $\sum \gamma_i \Delta z_i$ ),  $N_c$ ,  $N_\gamma$ , and  $N_q$  = bearing capacity factors, and the  $\zeta$  terms are modifications factors to account for foundation shape ( $s$ ), depth ( $d$ ), and rigidity ( $r$ ). The first subscript indicates the term in Equation C-20 to which the  $\zeta$  factor applies.

The bearing capacity factors are functions of soil friction angle  $\phi$ , as follows:

$$N_q = \tan^2 \left( 45 + \frac{\phi}{2} \right) e^{\pi \tan \phi} \quad C-21$$

$$N_c = (N_q - 1) \cot \phi \quad (\text{as } \phi \rightarrow 0, N_c = 5.14) \quad C-22$$

$$N_\gamma = 2(N_q + 1) \tan \phi \quad C-23$$

For a circular cross section (drilled shaft), expressions for the modification factors are given in **TABLE C-1**. Application of Equation C-20 to drilled shaft base resistance is considered for the three cases of drained loading in soil, undrained loading in soil, and rock.

### C.2.1 Drained Loading

Fully-drained response can be assumed for shafts bearing on cohesionless soils or for shafts bearing on cohesive soils where the long-term condition may be critical. The latter case generally applies to heavily overconsolidated cohesive soils. For drained loading, the problem is analyzed in terms of effective stress and it is usually assumed that the effective stress cohesion  $c'$  is zero. For these assumptions, and considering values for the modification factors as given in **TABLE C-1**, Equation C-20 reduces to the following:

$$q_{ult} = 0.3 B \bar{\gamma} N_{\gamma} \zeta_{\gamma r} + \bar{q} N_q \zeta_{qs} \zeta_{qd} \zeta_{qr}$$

C-24

in which  $\bar{\gamma}$  = average effective unit weight,  $N_{\gamma}$  and  $N_q$  are functions of soil effective stress friction angle ( $\phi'$ ),  $\bar{q}$  = vertical effective stress at the base elevation, and the remaining  $\zeta$  terms are evaluated from Table C-1. The soil properties ( $\phi'$ ,  $\bar{\gamma}$ , and  $I_{rr}$ ) are average values over the depth interval extending from the base of the shaft to one shaft diameter below the base.

**TABLE C-1 MODIFICATION FACTORS FOR CIRCULAR FOUNDATIONS  
(KULHAWY 1991)**

Modification	Symbol	Value
Shape	$\zeta_{cs}$	$1 + \frac{N_q}{N_c}$
	$\zeta_{\gamma s}$	0.6
	$\zeta_{qs}$	$1 + \tan \phi$
Depth	$\zeta_{cd}$	$\zeta_{qd} - \left[ \frac{1 - \zeta_{qd}}{N_c \tan \phi} \right]$
	$\zeta_{\gamma d}$	1
	$\zeta_{qd}$	$1 + 2 \tan \phi (1 - \sin \phi)^2 \left[ \frac{\pi}{180} \tan^{-1} \left( \frac{D}{B} \right) \right]$
Rigidity	$\zeta_{cr}$	$\zeta_{qr} - \left[ \frac{1 - \zeta_{qr}}{N_c \tan \phi} \right]$
	$\zeta_{\gamma r}$	$\zeta_{qr}$
	$\zeta_{qr}$	$\exp \left\{ [-3.8 \tan \phi] + \left[ (3.07 \sin \phi) \frac{\log_{10} I_{rr}}{1 + \sin \phi} \right] \right\}$

To evaluate the rigidity modification factors, the soil rigidity index ( $I_r$ ) must be evaluated and compared to the critical rigidity index (Vesic 1975). For drained loading and  $c' = 0$ , the soil rigidity index is given by:

$$I_r = \frac{E_d}{2((1 + \nu_d) \bar{q}_a \tan \phi')} \quad \text{C-25}$$

in which  $E_d$  = soil drained modulus,  $\nu_d$  = drained Poisson's ratio, and  $\bar{q}_a$  = average vertical effective stress from the base to one diameter below the base. Drained modulus can be estimated on the basis of relative density or correlated to in-situ test results for cohesionless soils (Chapter 3). For cohesive soils, drained modulus must be evaluated from consolidated-drained (CD) triaxial compression tests on undisturbed samples. Poisson's ratio of granular soils ranges from 0.1 to 0.4 and can be estimated from (Kulhawy, 1991):



$$v_d = 0.1 + 0.3 \phi_{rel} \quad C-26$$

in which the relative friction angle ( $\phi_{rel}$ ) ranges from 0 to 1 and is given by:

$$\phi_{rel} = \frac{\phi' - 25^\circ}{45^\circ - 25^\circ} \quad C-27$$

Equation C-27 has not been validated for calcareous or cemented soils. The reduced rigidity index utilized in the expressions given in Table C-1 accounts for volumetric strain and is given by (Vesic 1975):

$$I_{rr} = \frac{I_r}{1 + I_r \Delta} \quad C-28$$

in which  $\Delta$  = volumetric strain, which can be estimated by:

$$\Delta = 0.005 \frac{1 - \phi_{rel}}{\bar{q}_a / p_a} \quad C-29$$

where  $p_a$  = atmospheric pressure in the same units as  $\bar{q}_a$ . Equation C-29 also has not been validated for cemented or calcareous soils.

The reduced rigidity index ( $I_{rr}$ ) is compared to the critical rigidity index ( $I_{rc}$ ) given by (Vesic 1975):

$$I_{rc} = 0.5 \exp \left[ 2.85 \cot \left( 45^\circ - \frac{\phi'}{2} \right) \right] \quad C-30$$

If  $I_{rr} \geq I_{rc}$ , the soil beneath the base behaves as a rigid-plastic material resulting in general shear failure mode and the rigidity modification factors are equal to 1.0. If  $I_{rr} < I_{rc}$ , the assumption of rigid-plastic behavior is not satisfied and local or punching shear failure mode is likely. In this case, the rigidity modification factors will be less than 1.0 and should be evaluated from the expressions given in Table C-1.

### C.2.2 Undrained Loading

Undrained bearing capacity is evaluated in terms of total stress with  $\phi = 0$  and  $c$  = undrained shear strength ( $s_u$ ). The bearing capacity factors become:  $N_c = 5.14$ ,  $N_\gamma = 0$ , and  $N_q = 1.0$ . For  $\phi = 0$  the modification factors applied to the third term in Equation C-20 ( $\zeta_{qs}$ ,  $\zeta_{qd}$ ,  $\zeta_{qr}$ ) are equal to 1.0, and the shape factor  $\zeta_{cs} = 1.2$ . Equation C-20 then becomes:

$$q_{ult} = 6.17 c_u \zeta_{cd} \zeta_{cr} + q \quad C-31$$

in which  $q$  = total vertical stress at the base elevation ( $= \sum \gamma_i \Delta z_i$ ) and  $\gamma$  indicates soil total unit weight. The remaining modification factors are given by the expressions in Table C-2.

**TABLE C-2 MODIFICATION FACTORS FOR CIRCULAR FOUNDATION,  $\phi = 0$**

Modification	Symbol	Value
Depth	$\zeta_{cd}$	$1 + 0.33 \left[ \frac{\pi}{180} \tan^{-1} \left( \frac{D}{B} \right) \right]$
Rigidity	$\zeta_{cr}$	$0.44 + 0.60 \log_{10} I_r$

The undrained rigidity index is required to evaluate the rigidity modification factor, and is given by:

$$I_r = \frac{E_u}{2(1 + \nu_u)c_u} = \frac{E_u}{3c_u} \quad \text{C-32}$$

in which  $E_u$  = soil undrained modulus and  $\nu_u$  = undrained Poisson's ratio which is taken as 0.5 for saturated cohesive soils. Considering that zero volume change occurs during undrained loading, the rigidity index is not reduced to account for volume change. The rigidity index is compared to the critical rigidity index, which by Equation C-30 is  $I_{rc} = 8.64$ . If  $I_r \geq I_{rc}$ , general shear failure mode is assumed and  $\zeta_{cr} = 1.0$ . If  $I_r < I_{rc}$ , local or punching shear is assumed and  $\zeta_{cr}$  is less than one and is computed by the expression given in Table C-2.

Examination of the depth factor  $\zeta_{cd}$  as given in Table C-2 shows that as the depth to diameter ratio of a shaft ( $D/B$ ) goes to infinity,  $\zeta_{cd}$  reaches an upper bound value of 1.52, and Equation C-31 becomes:

$$q_{ult} = 9.37 s_u \zeta_{cr} + q \quad \text{C-33}$$

Practically, when  $D/B$  reaches 5, the first term in Equation C-33 is approximately equal to 9. Furthermore, if general shear failure mode occurs, which is often the case when the shaft is bearing on stiff clay ( $s_u > 2,000$  psf), then  $\zeta_{cr} = 1$ . Equation C-33 forms the basis of the recommendation given in Chapter 13 (see Equation 13-18) for approximation of undrained bearing capacity as:

$$q_{BN} = N_c^* s_u \quad \text{C-34}$$

with values of the bearing capacity factor  $N_c^*$  given in Table 13-2 and ranging from 6.5 to 9.0 depending on the range of undrained shear strength of the cohesive soil beneath the base of the shaft (O'Neill and Reese 1999). The recommendations given in Chapter 13 are suitable for routine design. More refined analyses can be conducted by application of Equation C-33 with evaluation of the various factors as described above. In most cases the computed nominal base resistance will not differ significantly.

### C.2.3 Bearing Capacity in Rock

Rock mass can exhibit a wide range of bearing failure modes because of the presence of discontinuities. A few of the special cases in which bearing capacity analysis can be put to practical use in the design of drilled shaft foundations are outlined herein.

Rock mass exhibiting strength behavior that can be described adequately using the Hoek-Brown strength criterion (Chapter 3) lends itself to bearing capacity analysis. The Hoek-Brown criterion is applicable to either intact rock or to fractured rock mass where strength is not controlled by one or two sets of discontinuities (structurally controlled). For rock mass satisfying this criterion, a general wedge type failure mode is assumed to develop beneath the tip of the shaft (Figure C-7) and the ultimate bearing capacity can be approximated using the Bell solution for plane-strain conditions, given by:

$$q_{ult} = cN_c s_c + \frac{B}{2} \gamma N_\gamma s_\gamma + \gamma D N_q s_q \quad \text{C-35}$$

in which  $B$  = socket diameter,  $\gamma$  = effective unit weight of the rock mass,  $D$  = foundation depth,  $N_c$ ,  $N_\gamma$ , and  $N_q$  are bearing capacity factors, and  $s_c$ ,  $s_\gamma$ , and  $s_q$  are shape factors to account for the circular cross-section. The bearing capacity factors and shape factors are given by:

$$N_c = 2\sqrt{N_\phi} (N_\phi + 1) \quad \text{C-36}$$

$$N_\gamma = \sqrt{N_\phi} (N_\phi^2 - 1) \quad \text{C-37}$$

$$N_q = N_\phi^2 \quad \text{C-38}$$

$$N_\phi = \tan^2 \left( 45^\circ + \frac{\phi}{2} \right) \quad \text{C-39}$$

$$s_c = 1 + \frac{N_q}{N_c} \quad \text{C-40}$$

$$s_\gamma = 0.6 \quad \text{C-41}$$

$$s_q = 1 + \tan \phi \quad \text{C-42}$$

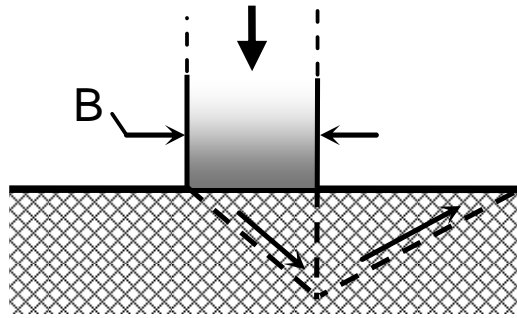


Figure C-7 Assumed General Wedge Failure Mode for Fractured Rock Mass

In the above equations, the values of  $c$  and  $\phi$  are rock mass effective stress strength properties. Practical estimates of  $c$  and  $\phi$  for a fractured rock mass can be obtained in two ways: (1) laboratory triaxial testing of core samples, and (2) by correlation to rock mass indexes such as the Geological Strength Index (GSI) described in Chapter 3. Most transportation agencies do not conduct triaxial testing of rock for foundation design. The most useful approach is to make practical estimates of rock mass strength based on a combination of uniaxial compression tests on intact rock and descriptions of the rock mass based on core logging. This approach is described in Chapter 3, including methods to establish GSI. Additionally, a computer program that provides estimates of the Mohr-Coulomb strength parameters  $c$  and  $\phi$  based on rock type, GSI, and uniaxial compressive strength, is available and can be downloaded from the following website: <http://www.rocscience.com/hoek/Hoek.asp> (Rocscience, Inc. 2007). The resulting values of  $c$  and  $\phi$  can be used in Equations C-35 through C-42 to compute the bearing capacity.

An alternative approach is to formulate the bearing capacity problem directly in terms of the Hoek-Brown strength criterion (instead of Mohr-Coulomb strength parameters). The basic derivation is given in Kulhawy and Carter (1992) and extended by Turner (2006) to include the effects of overburden stress. Using the same approximate method assumed in the Bell solution (plane-strain wedge failure mode), the failure mass beneath the foundation is idealized as consisting of two zones as shown in Figure C-8. The active zone (Zone 1) is subjected to a major principal stress ( $\sigma_1'$ ) coinciding at failure with the ultimate bearing capacity ( $q_{ult}$ ) and a minor principal stress ( $\sigma_3'$ ) that satisfies equilibrium with the horizontal stress in the adjacent passive failure zone (Zone 2). In Zone 2 the minor principal stress is vertical and conservatively assumed to be zero (initially) while the major principal stress, acting in the horizontal direction, is the ultimate strength according to the Hoek-Brown criterion. From Chapter 3, the strength criterion is given by:

$$\sigma_1' = \sigma_3' + q_u \left( m_b \frac{\sigma_3'}{q_u} + s \right)^a \quad \text{C-43}$$

where  $\sigma_1'$  and  $\sigma_3'$  = major and minor principal effective stresses, respectively,  $q_u$  = uniaxial compressive strength of intact rock, and  $m_b$ ,  $s$ , and  $a$  are the empirically determined Hoek-Brown strength parameters for the rock mass (Chapter 3).

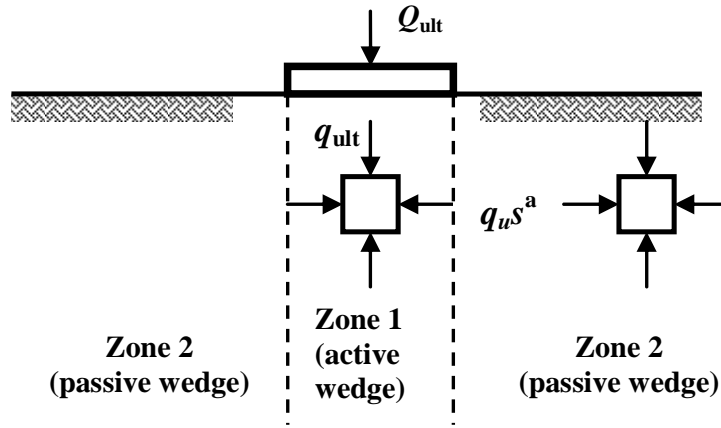


Figure C-8 Bearing Capacity Analysis

For Zone 2, setting the vertical stress  $\sigma'_3 = 0$  and solving Equation C-43 for  $\sigma'_1$  yields:

$$\sigma'_1 = \sigma'_H = q_u s^a \quad \text{C-44}$$

where  $\sigma'_H$  = horizontal stress in Zone 2. To satisfy equilibrium, the horizontal stress given by Equation C-44 is set equal to  $\sigma'_3$  in Zone I. Substituting  $\sigma'_3 = q_u s^{0.5}$  into Equation C-43 and considering that  $\sigma'_1 = q_{ult}$  yields:

$$q_{ult} = q_u \left[ s^a + (m_b s^a + s)^a \right] \quad \text{C-45}$$

The assumption of zero vertical stress at the bearing elevation may be overly conservative for many rocket sockets. A similar derivation can be carried out with the overburden stress taken into account, resulting in the following:

Let: 
$$A = \sigma'_{v,b} + q_u \left[ m_b \frac{(\sigma'_{v,b})}{q_u} + s \right]^a \quad \text{C-46}$$

where  $\sigma'_{v,b}$  = vertical effective stress at the socket bearing elevation, which is also the minor principal stress in Zone 2. Then:

$$q_{ult} = A + q_u \left[ m_b \left( \frac{A}{q_u} \right) + s \right]^a \quad \text{C-47}$$

Note that Equations C-46 and C-47 are presented in Chapter 13 as Equations 13-26 and 13-27. A limitation of these expressions is that they are based on the assumption of plane-strain conditions, corresponding to a strip footing. Kulhawy and Carter (1992) note that for a circular foundation the

horizontal stress between the two assumed failure zones may be greater than for the plane-strain case, resulting in higher bearing capacity. The analysis is therefore conservative for the case of drilled shafts.

Equations C-45, C-46, and C-47 require the foundation designer to establish representative values of the following rock mass properties beneath the base of the drilled shaft: uniaxial compressive strength of intact rock ( $q_u$ ), lithology or rock type, which determines the value of the coefficient  $m_i$  (see Table 3-5), and the Geological Strength Index (GSI) of the rock mass. The coefficients  $s$ ,  $a$ , and  $m_b$  are the Hoek-Brown strength parameters for the intact or fractured rock mass determined as functions of  $GSI$  in Equations 3-13 through 3-15. Based on these relationships, a correlation can be made between  $GSI$ , the coefficient  $m_i$ , and the ratio of bearing capacity to uniaxial compressive strength of intact rock ( $q_{ult}/q_u$ ) for the assumption of zero overburden stress, *i.e.*, for Equation C-45. This relationship is shown graphically in Figure C-9. The bearing capacity ratio is limited to an upper bound value of 2.5, based on the recommendation given by Rowe and Armitage (1987) to limit design base resistance of shafts in intact rock to 2.5 times  $q_u$ . To account for the overburden stress, Equations C-46 and C-47 can be used.

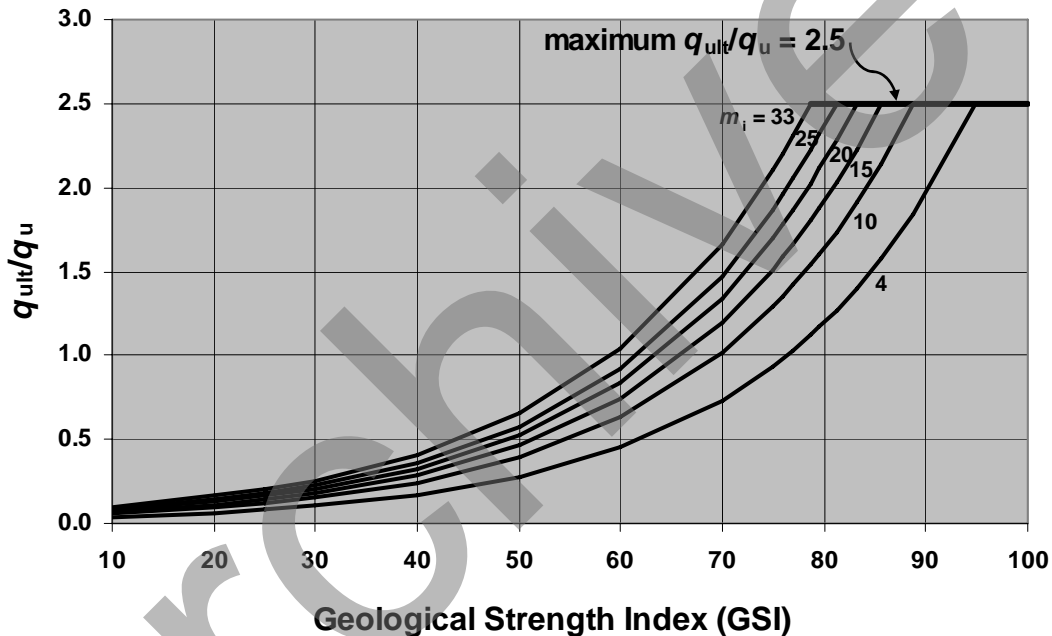


Figure C-9 Bearing Capacity Ratio Versus GSI and Rock Type (Turner, 2006)

As noted in Chapter 13, the above equations for bearing capacity in rock have not been adequately verified by load tests. Considering the range of base resistances that are possible and the uncertainty associated with rock mass characteristics, field load testing should be considered as part of the design process for all projects involving drilled shafts bearing on or socketed into rock. One issue that may be of importance in rock mass that is highly fractured and has a low GSI is the magnitude of displacement required to mobilize the base resistance as predicted by the above equations. This is a topic requiring further study.

Additional references on the application of theoretical bearing capacity models to foundations in rock include Sowers (1976), Kulhawy and Carter (1992), Turner (2006), and Kulhawy and Prakoso (2007). These include models that account for the strength, orientation, and number of joint sets. Although such detailed information is often not available for drilled shaft design, these more elaborate models may be warranted in some cases.

### C.3 BASE RESISTANCE WITH BASE GROUTING

Post-grouting at the base of drilled shafts bearing in cohesionless soils has been shown to improve the load-displacement behavior by increasing base resistance and decreasing the downward displacement needed to mobilize base resistance. The method that follows is presented here for informational purposes and is not covered in current AASHTO (2007) specifications. No resistance factors have been established for application of this method within the LRFD design format.

Mullins et al. (2006) recommend the following procedure for predicting base resistance of post-grouted shafts in cohesionless soils.

1. Calculate the nominal base resistance of the ungrouted shaft by Equation 13-16, corresponding to a displacement of 5% of base diameter; denote this value by  $q_{BN,5\%}$ .
2. Calculate the nominal side resistance,  $R_{SN}$ , for the total length of embedded shaft.
3. Divide the nominal side resistance by the cross-sectional area of the shaft to determine the anticipated maximum grout pressure,  $GP_{max}$ , or:

$$GP_{max} = \frac{R_{SN}}{A_{shaft}} \quad C-48$$

4. Calculate the Grout Pressure Index (GPI):

$$GPI = \frac{GP_{max}}{q_{BN,5\%}} \quad C-49$$

5. Establish the tolerable settlement ( $\delta_t$ ); express this as a percentage of the shaft diameter and denote this as ( $\delta_t/B$  %). Note that  $\delta_t$  is also associated with service limit state evaluation in Step 11-7 of the step-by-step procedure for axial load design described in Chapter 13.
6. Determine the Tip Capacity Multiplier (TCM) by:

$$TCM = 0.713 * GPI \left( \frac{\delta_t}{B} \% \right)^{0.364} + \left[ \frac{\frac{\delta_t}{B} \%}{.4 \left( \frac{\delta_t}{B} \% \right) + 3} \right] \quad C-50$$

7. Estimate the nominal base resistance of the post-grouted shaft as the product of the Tip Capacity Multiplier (Step 6) and the nominal base resistance of the ungrouted shaft (Step 1).

$$q_{BN,grouted} = TCM \times q_{BN,5\%} \quad C-51$$

To evaluate directly the effect of post-grouting on nominal unit base resistance, values of  $q_{BN}$  for both grouted and un-grouted cases can be determined at the same value of normalized settlement, corresponding to 5 percent of base diameter. The un-grouted unit base resistance is determined by Equation 13-16 and the grouted base resistance (Equation C-50) reduces to:

$$q_{BN,grouted} = [1 + 1.28GPI]q_{BN,5\%} \quad C-52$$

Values of the tip capacity multiplier (TCM) measured in field tests by Mullins et al. (2006), corresponding to displacement of 5 percent of shaft diameter, range from 3 to greater than 9, depending on grout pressure. These results demonstrate the potential of base grouting to improve the mobilization of base resistance in sands at smaller downward displacements than normally required for the un-grouted base. However, it is noted that base load transfer improvements will depend upon the quality of the equipment and techniques used, and variations due to these factor have not been quantified at this point. It would also not be acceptable to assume that base grouting can be a substitute for quality construction and/or proper base inspection practices.

#### C.4 DRILLED SHAFT WITH ENLARGED BASE (BELLED)

It is noted in Chapter 13 that the practice of constructing belled shafts on transportation projects has become very rare. It was apparently a common practice in the past in some regions of the U.S. as a means to increase base resistance in cohesive soils by providing a larger tip bearing area. The previous version of this manual included design methods for the base resistance of belled shafts in cohesive soils under compression and for the uplift resistance of a belled shaft. Both methods are given below.

##### C.4.1 Base Resistance Reduction for Belled Shafts

For the case of a belled shaft in cohesive soil for which base resistance is calculated using Equations 13-18 or 13-19, O'Neill and Reese (1999) recommended the following empirical relationship to establish a reduced nominal base resistance for bell diameters exceeding 6 ft, in particular if settlement analyses are not performed:

$$\text{reduced } q_{BN} = q_{BN, \text{by Eq. 13-18 or 13-19}} \times \left[ \frac{2.5}{0.028 B_b^2 + 0.083L + 0.035\sqrt{s_u}} \right] \quad C-53$$

where  $B_b$  = diameter of the base of the bell (ft),  $L$  = depth of the base below the ground surface, and  $s_u$  = mean undrained shear strength of cohesive soil beneath the base (over two base diameters). Application of Equation C-53 is not intended for straight-sided shafts. The relationship is given here mainly to provide historical context. No attempt is made herein to recommend a resistance factor for use with Equation C-53.



### C.4.2 Uplift Resistance of Belled Shafts

Figure C-10 shows a belled shaft with a shaft diameter of  $B$  and a bell diameter of  $B_b$  embedded into a cohesive founding stratum of depth  $D_b$ . When the depth of embedment into the stratum in which the bell is constructed is less than nine times the bell diameter ( $D_b/B_b \leq 9$ ), a simple model based on Vesic (1971) that treats the belled shaft as an anchor can be used to estimate the nominal uplift resistance for short-term undrained loading. In this treatment, the passive resistance of the soil above the bell provides the uplift resistance and the side resistance along the shaft above the bell is conservatively neglected.

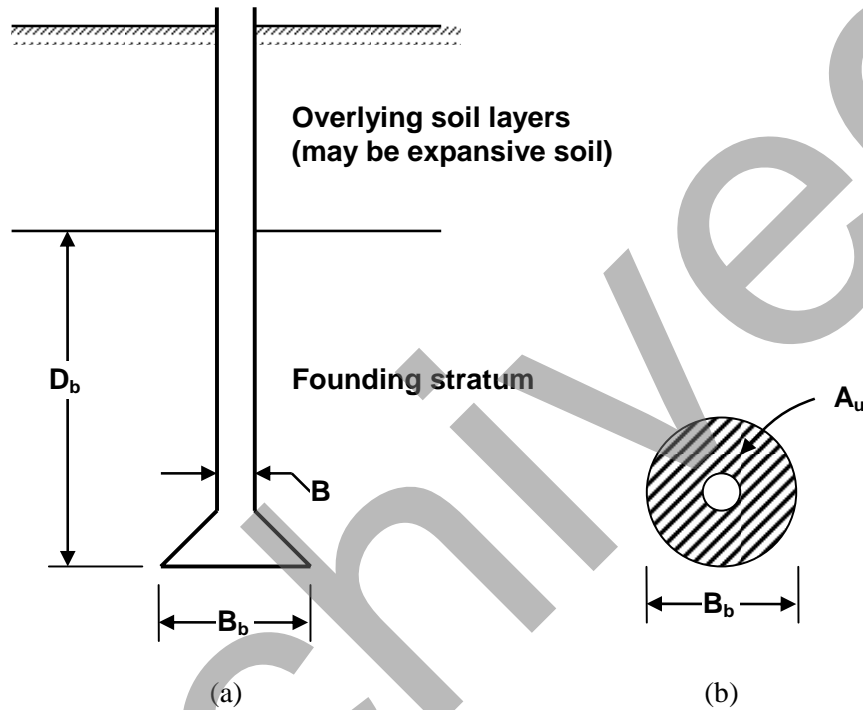


Figure C-10 (a) Geometry of Belled Shaft and (b) Projected Area of Bell in Uplift

Uplift resistance is given by:

$$R_{uN, \text{bell}} = q_{uN, \text{bell}} A_u \quad \text{C-54}$$

where  $R_{uN, \text{bell}}$  = nominal uplift resistance of the belled shaft,  $q_{uN, \text{bell}}$  = nominal unit uplift resistance of the bell, and  $A_u$  = projected area of the bell that is effective in mobilizing the passive resistance of the overburden soil. As shown in Figure C-10b, the projected area is given by:

$$A_u = \frac{\pi}{4} (B_b^2 - B^2) \quad \text{C-55}$$

The unit uplift resistance is given by:

$$q_{uN, \text{bell}} = N_u s_u$$

C-56

where  $N_u$  = dimensionless bearing capacity factor and  $s_u$  = undrained shear strength averaged over a depth of two bell diameters ( $2.0 B_b$ ) above the base or over the depth of embedment  $D_b$ , whichever is smaller. The value of  $N_u$  may be assumed to vary linearly from zero at  $D_b/B_b = 0.75$  to a maximum value of 8.0 at  $D_b/B_b \geq 2.5$ , where  $D_b$  = depth interval between the top of the founding stratum and the base of the bell (Yazdanbod et al. 1987). O'Neill and Reese (1999) recommend using a lower-bound value of  $N_u = 0.7$  if the cohesive soil is fissured.

If the belled shaft is being designed to resist uplift caused by expansive soil, the elevation of the founding stratum in Figure C-10a is taken as the maximum depth of seasonal moisture change (see Section 13.6).

## REFERENCES

AASHTO (2007), *AASHTO LRFD Bridge Design Specifications*, Customary U.S. Units, 4<sup>th</sup> Ed., 1510 p.

Allen, T. M., (2005). "Development of Geotechnical Resistance Factors and Downdrag Load Factors for LRFD Foundation Strength Limit State Design," *Publication No. FHWA-NHI-05-052*.

Chen, Y-J, and Kulhawy, F.H. (2002). "Evaluation of Drained Axial Capacity for Drilled Shafts," *Geotechnical Special Publication No. 116, Deep Foundations 2002*, M.W. O'Neill and F.C. Townsend, Editors, ASCE, Reston, VA, pp. 1200-1214.

Hirany, A. and Kulhawy, F.H. (1989). "Interpretation of Load Tests on Drilled Shafts—Part I: Axial Compression," *Foundation Engineering: Current Principles and Practices*, Vol. 2, Edited by F.H. Kulhawy, ASCE, New York, NY, pp. 1132-1049.

Hirany, A. and Kulhawy, F.H. (2002). "On the Interpretation of Drilled Foundation Load Test Results," *Geotechnical Special Publication No. 116, Deep Foundations 2002*, M.W. O'Neill and F.C. Townsend, Editors, ASCE, Reston, VA, pp. 1018-1028..

Kulhawy, F.H. (1991). "Drilled Shaft Foundations." Chapter 14 in *Foundation Engineering Handbook*, 2<sup>nd</sup> Ed., H.-Y. Fang, Editor, Van Nostrand Reinhold, New York, pp. 537-552.

Kulhawy, F.H. and Carter, J.P. (1992). "Settlement and Bearing Capacity of Foundations on Rock Masses," Ch. 12, *Engineering in Rock Masses*, F.G. Bell, Editor, Butterworth-Heinemann, Oxford, pp. 231-245.

Kulhawy, F.H. and Chen, J.-R. (2007). "Discussion of 'Drilled Shaft Side Resistance in Gravelly Soils' by Kyle M. Rollins, Robert J. Clayton, Rodney C. Mikesell, and Bradford C. Blaise," *Journal of Geotechnical and Geoenvironmental Engineering*, ASCE, Vol. 133, No. 10, pp. 1325-1328.

Kulhawy, F.H. and Prakoso, W.A. (2007). "Issues in Evaluating Capacity of Rock Socket Foundations," *Proceedings, 16<sup>th</sup> Southeast Asian Geotechnical Conference*, Southeast Asian Geotechnical Society, Malaysia.

Kulhawy, F.H., and Mayne, P.W. (1990). "Manual on Estimating Soil Properties for Foundation Design," *Report No. EPRI EL-6800*, Electric Power Research Institute, Palo Alto, CA.

Kulhawy, F.H., Trautmann, C.H., Beech, J.F., O'Rourke, T.D., McGuire, W., Wood, W.A., and Capano, C. (1983). "Transmission Line Structure Foundations for Uplift-Compression Loading." *Report EL-2870*, Electric Power Research Institute, Palo Alto, CA, 412 p.

Mayne, P.W. (2007). "In-Situ Test Calibrations for Evaluating Soil Parameters." In *Characterisation and Engineering Properties of Natural Soils II*, (Proceedings, Singapore Workshop), Tan, Phoon, Hight & Leroueil (eds), Taylor & Francis Group, London, pp. 1601-1652.

Mayne, P.W., and Harris, D.E. (1993). "Axial Load-Displacement Behavior of Drilled Shaft Foundations in Piedmont Residuum," *FHWA Reference Number 41-30-2175*, Georgia Tech Research Corporation, Atlanta, GA.

Mullins, G., Winter, D., and Dapp, S. (2006). "Predicting End Bearing Capacity of Post-Grouted Drilled Shaft in Cohesionless Soils," *Journal of Geotechnical and Geoenvironmental Engineering*, Vol. 132, No. 4, pp. 478-487.

O'Neill, M.W., and Hassan, K.M. (1994). "Drilled Shafts: Effects of Construction on Performance and Design Criteria," *Proceedings, International Conference on Design and Construction of Deep Foundations*, U.S. Federal Highway Administration, pp. 137-187.

O'Neill, M.W., and Reese, L.C. (1978). "Load Transfer in a Slender Drilled Pier in Sand," Preprint 341, ASCE Spring Convention and Exposition, American Society of Civil Engineers, Pittsburgh, PA, 30 p.

O'Neill, M.W., and Reese, L.C. (1999). "Drilled Shafts: Construction Procedures and Design Methods," *Publication No. FHWA-IF-99-025*, Federal Highway Administration, Washington, D.C., 758 p.

Reese, L.C., and O'Neill, M.W. (1988). "Drilled Shafts: Construction Procedures and Design Methods," *Publication No. FHWA-HI88-042*, Federal Highway Administration, McLean, VA, 564 p.

Reese, L.C., and O'Neill, M.W. (1989). "New Design Method for Drilled Shafts from Common Soil and Rock Tests," *Foundation Engineering: Current Principles and Practices*, Vol. 2, Edited by F.H. Kulhawy, ASCE, New York, NY, pp. 1026-1039.

Rocscience, Inc. (2007), Computer program *RocTest* [online]. Available: <http://www.rocscience.com/hoek/Hoek.asp> [June 2007].

Rollins, K.M., Clayton, R.J., Mikesell, R.C., and Blaise, B.C. (2005). "Drilled Shaft Side Friction in Gravelly Soils," *Journal of Geotechnical and Geoenvironmental Engineering*, ASCE, Vol. 131, No. 8, pp. 987-1003.

Rowe, R.K. and Armitage, H.H. (1987). "A Design Method for Drilled Piers in Soft Rock," *Canadian Geotechnical Journal*, Vol. 24, pp. 126-142.

Sowers, G.F. (1976) "Foundation Bearing in Weathered Rock," *Rock Engineering for Foundations and Slopes*, ASCE, New York, NY, pp. 32-42.

Tomlinson, M.J. (1963). *Foundation Design and Construction*, John Wiley & Sons, Inc., New York, 749 p.

Turner, J.P. and Kulhawy, F.H. (1990). "Drained Uplift Capacity of Drilled Shafts Under Repeated Loading", *Journal of Geotechnical Engineering*, ASCE, Vol. 116, No. 3, pp. 470-491.

Turner, J.P. (2006). *NCHRP Synthesis 360: Rock-Socketed Shafts for Highway Structure Foundations*, Transportation Research Board, National Research Council, Washington, D.C., 148 p.

Vesic, A.S. (1971). "Breakout Resistance of Objects Embedded in Ocean Bottom," *Journal of the Soil Mechanics and Foundations Division*, ASCE, Vol. 97, No. SM9, pp. 1183-1205.

Vesic, A.S. (1975). "Bearing Capacity of Shallow Foundations." in *Foundation Engineering Handbook*, 1<sup>st</sup> Edition, H.F. Winterkorn and H.Y. Fang, Editors, Van Nostrand Reinhold, New York, pp. 121-147.

Vesic, A.S. (1977). "Design of Pile Foundations," *Synthesis of Highway Practice 42*, National Cooperative Highway Research Program, Transportation Research Board, National Research Council, Washington, D.C., 68 p.

Yazdanbod, A., Sheikh, S.A., and O'Neill, M.W. (1987). "Uplift of Shallow Underreams in Jointed Clay," in *Foundations for Transmission Line Towers*, GSP No. 8, J-L Briaud, Editor, ASCE, pp. 110-127.

Archived

Archived

This page is intentional left blank.

## **APPENDIX D**

### **ANALYSIS OF AXIAL LOAD- DEFORMATION RESPONSE**

Archived

Archived

This page is intentional left blank.



## APPENDIX D

### ANALYSIS OF AXIAL LOAD-DEFORMATION RESPONSE

Simple approximations of the axial load-deformation response of single drilled shafts under compression loading can be made on the basis of normalized displacement curves, such as Figure 13-10, developed by back-analysis of field load tests. Alternative approaches are available, some of which account more directly for soil-structure interaction and taking into account the soil and rock properties as well as characteristics of the shaft. These methods range from simple models based on elastic theory to sophisticated numerical methods requiring finite element computer codes. In this appendix, the essential features of methods that have proven useful for predicting the load-deformation response of drilled shafts for design applications are presented.

#### D.1 SIMPLE FORMULAS

This method provides an estimate of settlement for preliminary analysis or as an approximate check on other solutions. Vesic (1977) proposed the following equations to estimate settlement in the working load range of deep foundations in soils based on a general description of the soil and structural properties of the foundation.

$$w_T = w_c + w_{bb} + w_{bs} \quad \text{D-1}$$

in which  $w_T$  = settlement of the head of the shaft,  $w_c$  = elastic compression of the reinforced concrete shaft,  $w_{bb}$  = settlement of the base due to load transferred to the base, and  $w_{bs}$  = settlement of the base due to load transferred along the sides. The term  $w_c$  can be approximated as:

$$w_c = (Q_h - 0.5Q_{ms}) \frac{L}{(AE)_{shaft}} \quad \text{D-2}$$

in which  $L$  = length of the drilled shaft,  $A$  = cross-sectional area of the shaft,  $E$  = composite elastic modulus of the reinforced concrete shaft,  $Q_h$  = load applied to the head of the shaft, and  $Q_{ms}$  = mobilized side resistance. The effective elastic stiffness of the drilled shaft (product of elastic modulus and cross-sectional area) can be taken as:

$$(AE)_{shaft} = E_c (A_c + nA_s) \quad \text{D-3}$$

where  $E_c$  = modulus of the concrete,  $A_c$  = cross-sectional area of concrete,  $A_s$  = cross-sectional area of longitudinal steel reinforcement,  $n$  = modulus ratio =  $E_s/E_c$ , and  $E_s$  = elastic modulus of steel reinforcement.

Vesic (1977) recommended the following expressions for  $w_{bb}$  and  $w_{bs}$ :

$$w_{bb} = C_p \left( \frac{Q_{mb}}{B q_{\max}} \right) \quad \text{D-4}$$

$$w_{bs} = \left( 0.93 + 0.16 \sqrt{\frac{L}{B}} \right) C_p \left( \frac{Q_{ms}}{L q_{\max}} \right) \quad \text{D-5}$$

where  $Q_{mb}$  = load transferred to the shaft base,  $B$  = shaft diameter,  $L$  = shaft embedded length, and  $q_{\max}$  = nominal unit base resistance (bearing capacity).  $C_p$  is a factor that depends on soil characteristics and can be approximated from Table D-1. Consistent units must be used in Equations D-1 through D-5.

**TABLE D-1 VALUES OF  $C_p$  BASED ON GENERAL DESCRIPTION OF SOIL (VESIC 1977)**

Soil Description	$C_p$
Sand (dense to loose)	0.09 – 0.18
Clay (stiff to soft)	0.03 – 0.06
Silt (dense to loose)	0.09 – 0.12

## D.2 NUMERICAL SIMULATION OF LOAD TRANSFER

For layered soil profiles and/or where many potential loading cases and trial designs need to be analyzed, numerical (computer) simulation of the load-displacement curve is a practical alternative. Solutions are available in several formats including finite element analysis (FEM), boundary element analysis (BEM), and finite difference solutions. While FEM and BEM analyses may be justified on critical projects, the most widely used computer programs for this purpose employ a finite difference solution and this approach, known as the  $t$ - $z$  curve method (Reese and Seed, 1957), is described.

A free body diagram of a drilled shaft is shown in Figure D-1a. The applied head load is resisted by the combined side ( $R_s$ ) and base ( $R_b$ ) resistances. In Figure D-1b, the drilled shaft and supporting soil are idealized as a system of springs. The single spring representing the concrete shaft is linear and is used to model the elastic stiffness of the shaft under an applied axial load. Soil-structure interaction along the sides and base of the shaft are represented by a series of mechanisms (nonlinear springs). One example of the type of mechanism that can be used is shown in Figure D-1b, and consists of a cantilever spring and a friction block.

Analytical functions are used to represent each of the interaction mechanisms. In Figure D-1c, a family of curves is shown to represent the nonlinear relationship between mobilized unit side resistance ( $t$ ) and axial displacement ( $z$ ) of the drilled shaft, referred to as a “side load-transfer function”. A family of curves is used to illustrate that the  $t$ - $z$  relationship can vary with depth.

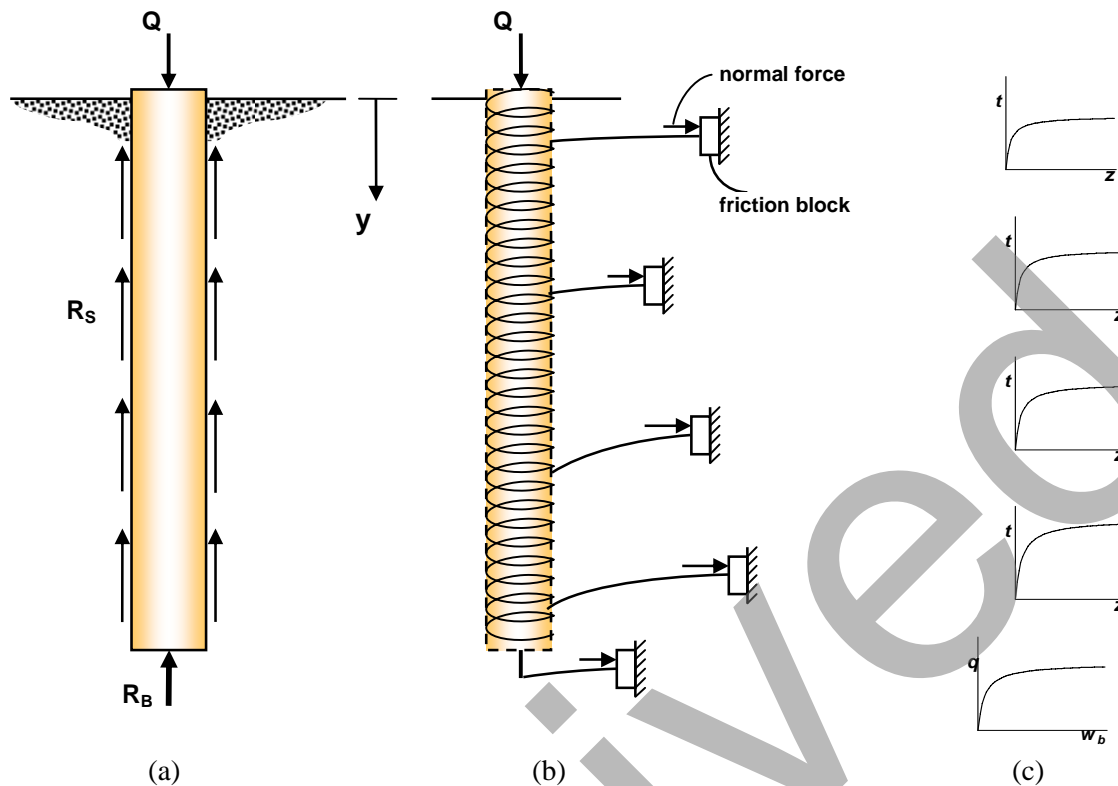


Figure D-1 Model of Axially Loaded Shaft

The number of  $t$ - $z$  curves used in a particular problem is determined by the need to capture the behavior of all the subsurface layers through which the shaft extends. The load-displacement response of the base of the shaft is modeled as a single nonlinear spring that describes the relationship between mobilized unit base resistance ( $q$ ) and base displacement ( $w_b$ ), referred to as a  $q$ - $w_b$  curve or “base load-transfer function”. Each nonlinear spring is discrete and independent of the other springs, meaning that this method does not satisfy continuity.

At any point along the shaft, the governing differential equation is given by:

$$EA \frac{d^2 z}{dy^2} = \pi B t \tag{D-6}$$

where  $EA$  = composite elastic axial stiffness of the reinforced concrete shaft (Equation D-3),  $B$  = shaft diameter, and depth is denoted by  $y$ . Solutions to Equation D-6 require a mathematical function relating the two variables  $t$  and  $z$  (or  $q$  and  $w$  at the base). In general, the load transfer functions can be expressed by:

$$t = \psi(z, y) z \tag{D-7}$$

where  $\psi$  denotes the secant slope to the  $t$ - $z$  curve at a specified value of deflection  $z_y$ , as shown in Figure D-2. Substituting Equation D-7 into Equation D-6 yields:

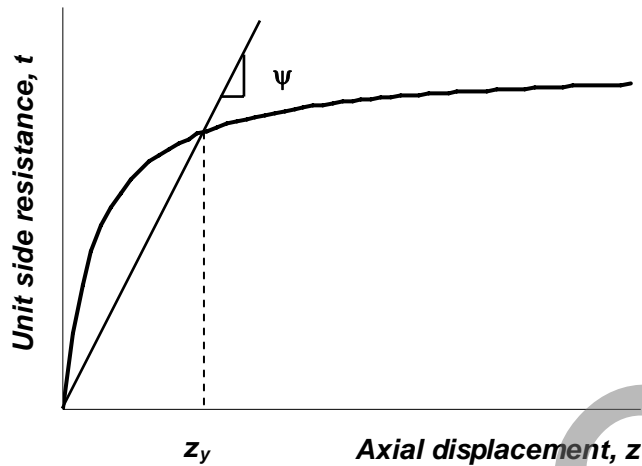


Figure D-2 Nonlinear  $t$ - $z$  Relationship

$$\frac{d^2 z}{dy^2} - \left( \frac{\pi B}{EA} \right) \psi(z, y) z = 0 \quad \text{D-8}$$

Equation D-8 can be solved numerically using a finite difference scheme with a specified boundary condition (load applied to the top of the shaft). For each value of axial load, the numerical solution yields values of axial displacement ( $z$ ) and mobilized unit side resistance ( $t$ ) for each specified value of depth ( $y$ ). From these data, a load versus head displacement curve can be constructed for the drilled shaft. Also, for each load increment, a curve of load versus depth (load transfer curve) can be calculated and constructed (e.g., Figure 13-1c). A detailed description of the finite difference equations used in the  $t$ - $z$  curve method is beyond the scope of this manual. However, several commercial software programs are available to solve this problem and the program documentation can be consulted for detailed information on the numerical methods. Programs for this analysis are listed in Section D.5.

The degree to which the  $t$ - $z$  curve method models the actual behavior of a drilled shaft depends upon the  $t$ - $z$  and  $q$ - $w_b$  curves (functions) used in the analysis. Load transfer functions can be estimated in a variety of ways, including finite element studies, elasto-plastic modeling of the soil-shaft interface, load test measurements, and laboratory shear tests. Commercially available software programs that perform this type of analysis provide the user with the option of using built-in load transfer functions or specifying user-generated curves. The built-in functions are based on recommendations developed from full-scale load tests in a variety of soil types. Section D.5 lists several computer codes available for performing  $t$ - $z$  curve analyses. User-generated curves can be developed from laboratory triaxial or direct shear tests in which the stress-strain behavior of the soil or soil-concrete interface is measured (for example, see Kraft et al., 1981). Some researchers have developed recommendations for  $t$ - $z$  curves for drilled shafts in specific materials, for example, cemented calcareous fine-grained soils (Walsh et al., 1995). However, research has not yet advanced to the point where load transfer curves can be predicted for all conditions with confidence. Construction practices and the particular response of a given soil or rock to drilling and concrete placement may also affect side and base load transfer.

An effective way to utilize the  $t$ - $z$  curve method is in conjunction with field load tests. This approach is particularly useful on projects where the subsurface stratigraphy is complex and load testing is conducted with instrumentation needed to establish the load transfer in each soil or rock layer. The numerical solution can be calibrated to establish agreement with load transfer determined from the load test, then utilized to model the load-deformation response of trial designs that may involve different depths and diameters than those of the load test.

### D.3 APPROXIMATE CLOSED-FORM SOLUTIONS

Closed-form solutions based on simplifying assumptions about the load transfer behavior of axially loaded drilled shafts can be valuable design aids. To be valid, closed form solutions should be verified by reasonable agreement with more sophisticated finite element analyses and by agreement with field load tests. The value of closed-form solutions lies in their ease of application, for example requiring a set of calculations that can be accomplished with a spreadsheet, thus enabling the designer to assess quickly the influence of design variables on the settlement behavior of the shaft. All such models are limited to the conditions assumed in their derivation, and care must be exercised not to apply the model to conditions outside of the validated range. Three such methods are described below. The first two are based on a procedure developed by Randolph and Wroth (1978) for elastic analysis of piles. The general form of the equations is therefore similar in both methods, but with different assumptions about the distribution of elastic modulus with depth.

#### D.3.1 Rock Sockets (Kulhawy and Carter 1992)

An approximate method given by Kulhawy and Carter (1992) provides simple closed-form expressions that compare reasonably well to more sophisticated nonlinear finite element analyses reported by Pells and Turner (1979) and Rowe and Armitage (1987). The basic problem is depicted in Figure D-3a and involves predicting the relationship between an axial compression load ( $Q_c$ ) applied to the top of a socketed shaft and the resulting axial displacement at the top of the socket ( $w_c$ ). The concrete shaft is modeled as an elastic cylindrical inclusion embedded within an elastic rock mass. The cylinder of depth  $L$  and diameter  $B$  has Young's modulus  $E_c$  and Poisson's ratio  $\nu_c$ . The rock mass surrounding the cylinder is homogeneous with Young's modulus  $E_r$  and Poisson's ratio  $\nu_r$  while the rock mass beneath the base of the shaft has Young's modulus  $E_b$  and Poisson's ratio  $\nu_b$ . The solution (Figure D-3b) approximates the load-deformation response of an axially loaded rock socket as consisting of two linear segments: (1) the initial linear elastic response and (2) the full slip condition. The maximum load is limited to the nominal axial resistance.

For compression loading, two cases are treated by Kulhawy and Carter (1992): (1) a "complete socket", for which full contact is assumed between the base of the concrete shaft and the underlying rock, and (2) a shear socket, for which a void is assumed to exist beneath the base. The shear socket solution would be useful in analyzing a load test in which base resistance is eliminated by creating a void beneath the base of the drilled shaft. Only the complete socket case will be treated here.

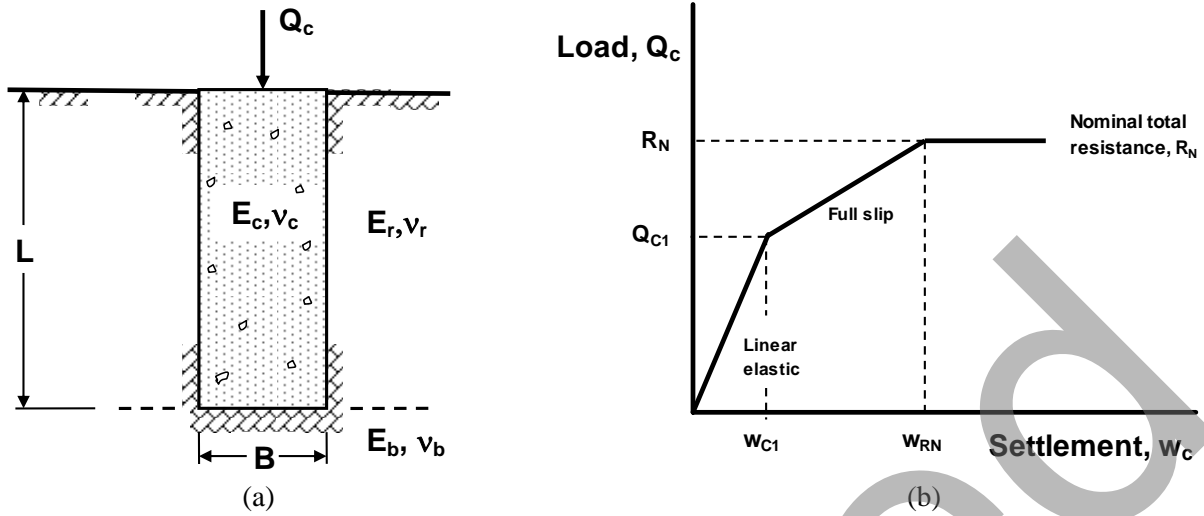


Figure D-3 Simplified Model of Axial Load-Deformation Behavior, Drilled Shaft in Rock; (a) Elastic model of Rock Socket; (b) Computed Bilinear Load-settlement Curve

1. For the linearly elastic portion of the load-displacement curve.

$$w_c = \frac{2Q_c}{G_r B} \frac{1 + \left( \frac{4}{1-\nu_b} \right) \left( \frac{1}{\pi\lambda\xi} \right) \left( \frac{2L}{B} \right) \left( \frac{\tanh[\mu L]}{\mu L} \right)}{\left( \frac{4}{1-\nu_b} \right) \left( \frac{1}{\xi} \right) + \left( \frac{2\pi}{\zeta} \right) \left( \frac{2L}{B} \right) \left( \frac{\tanh[\mu L]}{\mu L} \right)} \quad \text{D-9}$$

in which:

$$(\mu L)^2 = \left( \frac{2}{\zeta\lambda} \right) \left( \frac{2L}{B} \right)^2 \quad \text{D-10}$$

$$\zeta = \ln [5(1 - \nu_r)L/B] \quad \text{D-11}$$

$$\lambda = E_c/G_r \quad \text{D-12}$$

$$G_r = E_r / [2(1 + \nu_r)] = \text{elastic shear modulus of rock mass} \quad \text{D-13}$$

$$\xi = G_r/G_b \quad \text{D-14}$$

$$G_b = E_b / [2(1 + \nu_b)] \quad \text{D-15}$$

The magnitude of load transferred to the base of the shaft ( $Q_b$ ) is given by:

$$\frac{Q_b}{Q_c} = \frac{\left(\frac{4}{1-\nu_b}\right)\left(\frac{1}{\xi}\right)\left(\frac{1}{\cosh[\mu D]}\right)}{\left(\frac{4}{1-\nu_b}\right)\left(\frac{1}{\xi}\right) + \left(\frac{2\pi}{\zeta}\right)\left(\frac{2D}{B}\right)\left(\frac{\tanh[\mu D]}{\mu D}\right)}$$
D-16

2. For the full slip portion of the load–displacement curve.

$$w_c = F_3 \left( \frac{Q_c}{\pi E_r B} \right) - F_4 B$$
D-17

in which:

$$F_3 = a_1(\lambda_1 BC_3 - \lambda_2 BC_4) - 4a_3$$
D-18

$$F_4 = \left[ 1 - a_1 \left( \frac{\lambda_1 - \lambda_2}{D_4 - D_3} \right) B \right] a_2 \left( \frac{c}{E_r} \right)$$
D-19

$$C_{3,4} = \frac{D_{3,4}}{D_4 - D_3}$$
D-20

$$D_{3,4} = \left[ \pi(1-\nu_b^2) \left( \frac{E_r}{E_b} \right) + 4a_3 + a_1 \lambda_{2,1} B \right] \exp[\lambda_{2,1} D]$$
D-21

$$\lambda_{1,2} = \frac{-\beta \pm (\beta^2 + 4\alpha)^{1/2}}{2\alpha}$$
D-22

$$\alpha = a_1 \left( \frac{E_c}{E_r} \right) \left( \frac{B^2}{4} \right)$$
D-23

$$\beta = a_3 \left( \frac{E_c}{E_r} \right) B$$
D-24

$$a_1 = (1 + \nu_r)\zeta + a_2 \quad \text{D-25}$$

$$a_2 = \left[ (1 - \nu_c) \left( \frac{E_r}{E_c} \right) + (1 + \nu_r) \right] \left( \frac{1}{2 \tan \phi \tan \psi} \right) \quad \text{D-26}$$

$$a_3 = \left( \frac{\nu_c}{2 \tan \psi} \right) \left( \frac{E_r}{E_c} \right) \quad \text{D-27}$$

The magnitude of load transferred to the base of the shaft ( $Q_b$ ) is given by:

$$\frac{Q_b}{Q_c} = P_3 + P_4 \left( \frac{\pi B^2 c}{Q_c} \right) \quad \text{D-28}$$

in which:

$$P_3 = a_1(\lambda_1 - \lambda_2) B \exp[(\lambda_1 + \lambda_2)D] / (D_4 - D_3) \quad \text{D-29}$$

$$P_4 = a_2(\exp[\lambda_2 D] - \exp[\lambda_1 D]) / (D_4 - D_3) \quad \text{D-30}$$

Note that the point of intersection between the linear elastic portion of the curve and the full slip segment, defined by point ( $Q_{C1}$ ,  $w_{C1}$ ) in Figure D-3b, can be calculated by setting Equation D-9 equal to Equation D-17, solving for the resulting value of axial load ( $Q_{C1}$ ) and using this value to compute the corresponding displacement  $w_{C1}$ .

Numerical solutions to Equations D-9 through D-30 are implemented easily by spreadsheet, thus providing designers a simple analytical tool for assessing the likely ranges of behavior for trial designs. The user of this method should be familiar with the assumptions made in its development. The modulus of the rock mass is assumed to be constant over the depth of shaft embedment and beneath the base. Rock mass modulus and its variation with depth must, therefore, be assessed carefully (as described in Chapter 3) and determined to satisfy the assumption of uniformity. Strength of the rock mass is required in terms of its Mohr-Coulomb parameters ( $c$ ,  $\phi$ , and  $\psi$ ) where  $\psi$  = angle of dilatancy. In the absence of laboratory testing of the rock-concrete interface, for example by constant normal stiffness direct shear tests, Kulhawy and Carter (1992) suggest the following correlations between the Mohr-Coulomb strength parameters and uniaxial compressive strength ( $q_u$ ) of intact rock:

$$\frac{c}{P_a} = 0.1 \left( \frac{q_u}{P_a} \right)^{2/3} \quad \text{D-31}$$



$$\tan \phi \tan \psi = 0.001 \left( \frac{q_u}{p_a} \right)^{2/3} \quad \text{D-32}$$

To illustrate the application of this method, consider Illustrative Example 13-3 Chapter 13) in which a 2-ft diameter, 7.5-ft deep socket in competent limestone was analyzed for nominal axial resistance. The mean uniaxial compressive strength was 870 psi and the calculated total compressive resistance (side plus base) was 1,751 kips. Figure D-4 shows a spreadsheet solution in which the load-displacement behavior of the trial shaft is predicted and plotted using Equations D-9 through D-32.

The above method is best applied in conjunction with load testing of rock sockets, providing a framework for interpretation of the load test results by establishing values of the rock mass properties ( $E_r$ ,  $E_b$ ,  $c$ ,  $\phi$ , and  $\psi$ ). Where borings verify that the rock mass has similar lithology, strength, and discontinuity characteristics, the analysis can then be used to evaluate load-deformation behavior of trial designs. When combined with appropriate judgment and experience, the above approach represents a reasonable analysis of drilled shaft rock sockets.

### D.3.2 Dense Residual Piedmont Soils (Mayne and Harris 1993)

The following method suggested by Mayne and Harris (1993) also is based on the elasticity solution developed by Randolph and Wroth (1978). The authors showed reasonably good agreement between the elastic analysis and the load-displacement response of drilled shafts in residual Piedmont soils as measured in field load tests. The method also showed good agreement with results of load tests on drilled shafts in very dense granular glacial till (O'Neill et al., 1996) and was recommended for dense cohesionless soils with N-values greater than 50. The method requires calculation of nominal unit side and base resistances ( $f_{SN}$ ,  $q_{BN}$ ) using the methods presented in Chapter 13 ( $\beta$ -method for side resistance; Equation 13-16 for base resistance).

The following correlation equation is recommended to establish values of the soil modulus ( $E_s$ ) from Standard Penetration Test results:

$$\frac{E_s}{p_a} = 22 (N_{60})^{0.82} \quad \text{D-33}$$

in which:  $p_a$  = atmospheric pressure in the same units as  $E_s$ , and  $N_{60}$  = SPT N-value corrected for 60% energy efficiency. A best-fit straight line is used to model the distribution of soil modulus with depth, as illustrated in Figure D-5. The following modulus values are then defined:  $E_{sL}$  = value of soil modulus at the base of the shaft for the undisturbed in situ condition;  $E_b$  = effective modulus at the base of the shaft accounting for stress relief due to excavation, taken as  $0.4 E_{sL}$ , and  $E_{sm}$  = value of modulus at mid-depth of the shaft ( $L/2$ ).

The load versus settlement curve is then modeled as being bilinear, as illustrated in Figure D-3b, with a limiting value corresponding to the nominal axial compressive resistance,  $R_N$ . The endpoints of the linear elastic and full slip segments are determined by the origin and the two points defined by coordinates ( $Q_{C1}$ ,  $w_{C1}$ ) and ( $R_N$ ,  $w_{RN}$ ). At the upper end of the linear elastic segment, the full side resistance and some portion of the base resistance have been developed. At the end of the full slip segment, the full side and base resistances have been developed. The computations used to establish the points on the curve are as follows:

**Elastic Load-Settlement Analysis, Rock Socket in Compression**  
**by method of Kulhawy & Carter (1992)**

SHAFT PROPERTIES

Shaft diameter $B$ (in):	24
Shaft depth $D$ (in):	90
Modulus of concrete, $E_c$ (kip/in <sup>2</sup> ):	5075
Poissons ratio, $\nu_c$ :	0.25
Shear modulus, $G_c$ (kip/in <sup>2</sup> ):	2030

PROPERTIES OF SIDE ROCK MASS

Rock mass modulus $E_r$ (k/in <sup>2</sup> ):	100
Rock mass Poissons ratio, $\nu_r$ :	0.25
Shear modulus, $G_r$ (k/in <sup>2</sup> ):	40
cohesion, $c$ (lb/in <sup>2</sup> )	22.4
friction angle, $\phi$ (degrees)	28
dilation angle, $\psi$ (degrees)	1.67

PROPERTIES OF BASE ROCK MASS

Rock mass modulus $E_b$ (k/in <sup>2</sup> ):	100
Rock mass Poissons ratio, $\nu_b$ :	0.25
Shear modulus, $G_b$ (k/in <sup>2</sup> ):	40

DIMENSIONLESS CONSTANTS FOR LINEAR ELASTIC (calculated)

$\lambda = E_c / G_r$	126.875
$\zeta = \ln[5(1-\nu_r) D/B]$	2.64351168
$\xi = G_r / G_b$	1
$(\mu D)^2$	0.335424849
$\mu$	0.006435097
for complete socket: $G_r B w_c / 2C$	0.050954746

CALCULATED CONSTANTS FOR FULL SLIP

$a_3$	0.0845
$a_2$	40.7937
$a_1$	44.0981
$\beta$	102.8974
$\alpha$	322268.9
$\lambda_1$	0.0016
$\lambda_2$	-0.0019
$C_1$	-2.6674
$C_2$	-3.6674
$C_3$	0.2213
$C_4$	1.2213
$D_3$	1.0443
$D_4$	5.7632
$F_1$	11.6897
$F_2$	0.0091
$F_3$	2.5316
$F_4$	0.0019
$P_3$	0.77092
$P_4$	-2.72451

Equivalent Linear Spring Constants K

complete socket:  $K_c = Q_c / w_c$  9420.123586 k/in

Proportion of Load Transferred to Tip

complete socket:  $Q_{tip} / 2Q_c$  0.212549602

Linear Elastic Load-Displacement Calculations

<u>Complete Socket</u>	
$Q_c$ (kips)	Socket $w_c$ (in)
0	0.00
200	0.02

Full-Slip Load-Displacement Calculations

200	0.02
1751	0.54
1751	1.90

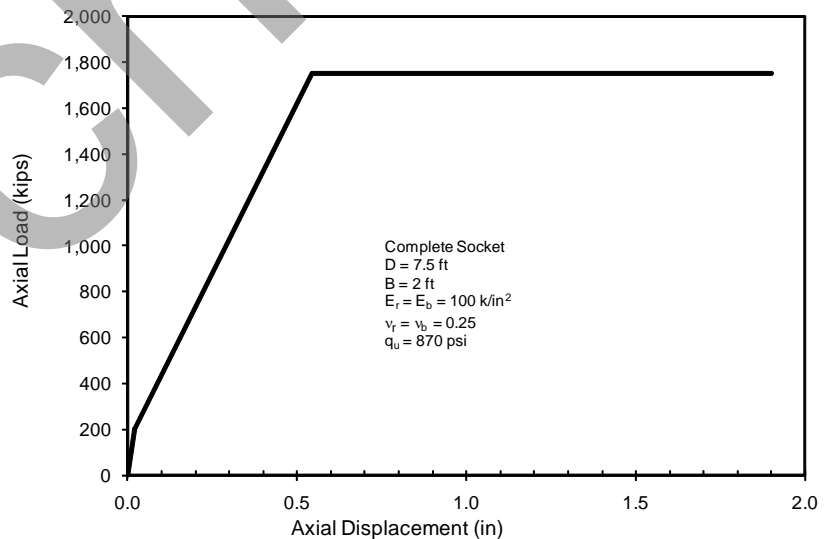


Figure D-4 Spreadsheet Analysis to Evaluate Load-Displacement of Rock Socket as Described in Illustrative Example 13-3

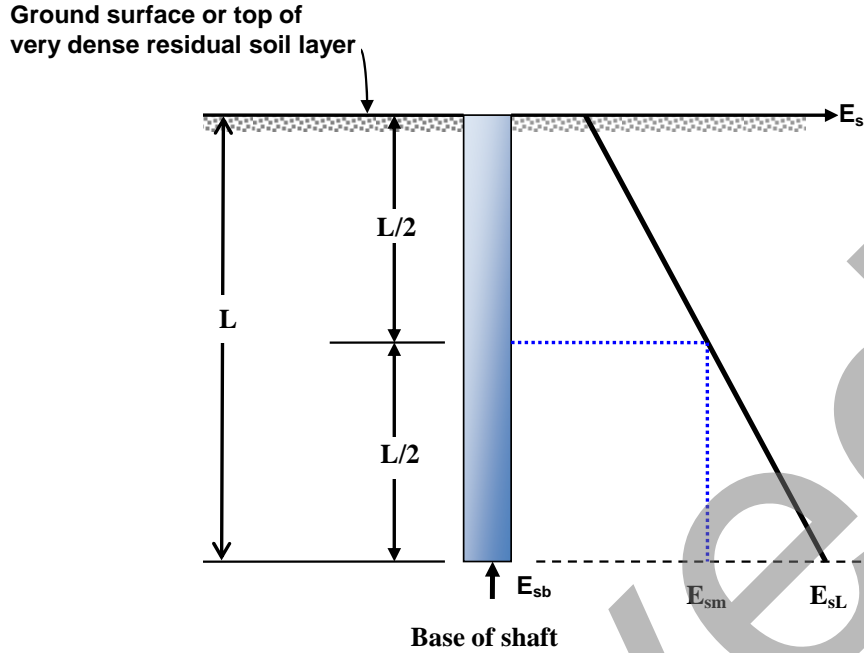


Figure D-5 Variation of Soil Modulus with Depth

$$Q_{c1} = \frac{f_{SN} \pi BL}{1 - \left\{ \frac{I}{[\xi \cosh(\mu L)](1 - \nu^2)} \right\}} \quad \text{D-34}$$

where  $I$  = elastic influence factor given by:

$$I = 4(1 + \nu) \left\{ \frac{1 + \frac{8 \tanh(\mu L)L}{\pi \lambda (1 - \nu) \xi (\mu L)L}}{\frac{4}{(1 - \nu) \xi} + \frac{4\pi \frac{E_{sm}}{E_{sl}} \tanh(\mu L)L}{\zeta (\mu L)B}} \right\} \quad \text{D-35}$$

$$\mu L = \left( \frac{L}{B} \right) 2 \sqrt{\frac{2}{\zeta \lambda}} \quad \text{D-36}$$

$$\zeta = \ln \left\{ \left[ 0.25 + \left( 2.5 \left( \frac{E_{sm}}{E_{sl}} \right) (1 - \nu) - 0.25 \xi \right) \right] \frac{2L}{B} \right\} \quad \text{D-37}$$

$$\lambda = 2(1 + \nu) \frac{E_c}{E_{sL}} \quad \text{D-38}$$

$$\xi = \frac{E_{sL}}{E_b} = 2.5 \quad \text{D-39}$$

in which:

$\nu$  = Poisson's ratio of the soil  
 $E_c$  = elastic modulus of the reinforced concrete shaft (composite)

The displacement corresponding to load  $Q_{C1}$  is given by:

$$w_{C1} = \frac{Q_{C1} I}{E_{sL} B} \quad \text{D-40}$$

The maximum load is the summation of the nominal side and base resistances, or;

$$R_N = f_{SN} (\pi BL) + q_{BN} \left( \frac{\pi B^2}{4} \right) \quad \text{D-41}$$

The additional displacement that occurs over the full slip segment is computed by considering that any additional load beyond  $Q_{C1}$  is transferred to the base, yielding the following:

$$\Delta w = (Q_T - Q_{T1}) \frac{(1 - \nu^2)}{E_b B} \quad \text{D-42}$$

The above method has been shown to give reasonable results for diameters up to 5 ft and is also implemented conveniently using a spreadsheet to perform the calculations.

### D.3.3 Cohesive IGM's O'Neill et al. (1996)

In this manual fine-grained sedimentary rock such as clay-shale and mudstone with uniaxial compressive strengths in the approximate range of 10 ksf to 100 ksf are classified as cohesive intermediate geomaterials (IGM). A method for predicting load-settlement behavior of drilled shaft sockets in these types of materials was developed by O'Neill et al. (1996). The proposed equations predict load-settlement curves that match well with results of numerical modeling by nonlinear finite element techniques and with full-scale field load tests on sockets in Texas clay-shales. The method applies only to the socket and does not address the resistance of the overburden, which can often be disregarded for design purposes.

Reference is made to Chapter 13 for the determination of nominal unit side resistance  $f_{SN}$  in a cohesive IGM socket (Equations 13-28 through 13-30). It is also necessary to select a value of the parameter  $n$ , based on whether the socket is smooth or rough. If the socket is classified as smooth,  $n$  can be obtained from Figure D-6. If the socket is classified as rough,  $n = \sigma_n/q_u$ , where  $\sigma_n$  is the effective interface normal stress at the depth where  $f_{SN}$  is determined (Equation 13-30) and  $q_u$  is the median unconfined compressive strength of the core samples over the length of the socket. Limitations of the method are discussed in more detail by O'Neill et al. (1996). An important assumption is that the behavior of the rock/shaft interface is ductile (does not exhibit deformation softening behavior following shear failure). The socket is assumed to consist of uniform geomaterial along the sides and beneath the base. Computations are best executed using a spreadsheet, examples of which are given in the reference cited above. The procedure is as follows:

Select a trial geometry for the socket, where  $D$  = penetration of the drilled shaft into the socket as opposed to the full length of the drilled shaft, and  $B$  = socket diameter. Determine the modulus of the rock mass,  $E_m$  (Chapter 3) and estimate the composite modulus of the reinforced concrete shaft,  $E_c$  (Equation D-3).

Compute the geometric characteristic terms

$$\Omega = 1.14 \sqrt{\frac{D}{B}} - 0.05 \left[ \sqrt{\frac{D}{B}} - 1 \right] \log_{10} \left( \frac{E_c}{E_m} \right) - 0.44 \quad \text{D-43}$$

$$\Gamma = 0.37 \sqrt{\frac{D}{B}} - 0.15 \left[ \sqrt{\frac{D}{B}} - 1 \right] \log_{10} \left( \frac{E_c}{E_m} \right) + 0.13 \quad \text{D-44}$$

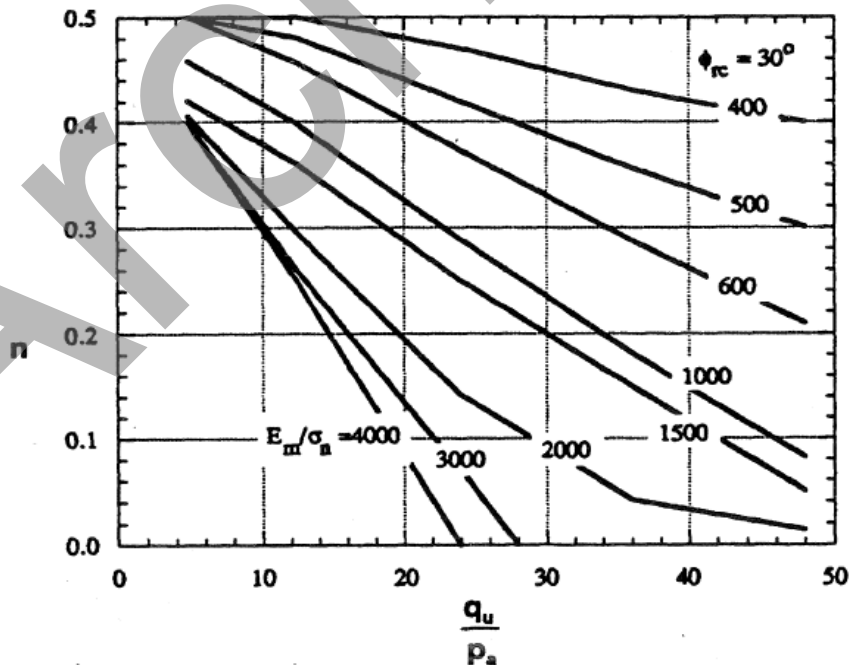


Figure D-6 Parameter  $n$  for Smooth Cohesive IGM Sockets (O'Neill et al. 1996)

Select a series of values of socket head displacement,  $w_c$ . For each value of  $w_c$ , a resistance (load applied to the head of the socket) corresponding to that displacement is computed in the following steps.

Compute the elastic-range settlement term:

$$H_f = \frac{E_m \Omega}{\pi D \Gamma f_{aa}} w_c \quad \text{D-45}$$

Compute the inelastic-range settlement term:

$$K_f = n + \frac{(H_f - n)(1 - n)}{H_f - 2n + 1} \leq 1 \quad \text{D-46}$$

Compute the net unit bearing stress reaching the base,  $q_b$

$$q_b = 0.0134 E_m \times \frac{\left(\frac{D}{B}\right)}{\left(\frac{D}{B} + 1\right)} \left\{ \frac{200 w_c \left[ \sqrt{\frac{D}{B}} - \Omega \right] \left(1 + \frac{D}{B}\right)^{0.67}}{\pi D \Gamma} \right\} \quad \text{D-47}$$

Compute  $Q_c$ , the compressive load applied at the top of the socket, corresponding to  $w_c$ :

If  $H_f \leq n$  (within the linear elastic range of displacement):

$$Q_c = \pi B L H_f f_{aa} + q_b \frac{\pi B^2}{4} \quad \text{D-48}$$

If  $H_f > n$  (within the inelastic range of displacement):

$$Q_c = \pi B L K_f f_{aa} + q_b \frac{\pi B^2}{4} \quad \text{D-49}$$

The method outlined above reportedly gives accurate predictions up to about 2 inches of settlement and for  $B$  up to about 6 ft. As a part of the design process the value of  $q_b$  that is computed should not exceed the nominal value  $q_{BN}$  computed by the methods presented in Chapter 13. Further information on base resistance of cohesive intermediate geomaterials (clay shales and other argillaceous sedimentary rocks) is given in O'Neill et al. (1996) and Abu-Hejleh et al. (2003).

#### D.4 OTHER METHODS

The computer program ROCKET models the axial load-displacement behavior of a rock socketed shaft based on the methods described by Seidel and Haberfield (1994). The analysis is based on:

- A computed  $t$ - $z$  response between each section of shaft and the adjacent rock (up to 15 rock layers can be included);

- base resistance which can be specified as either elasto-plastic or hyperbolic with limiting end bearing;
- Elastic deformation of the rock surrounding the pile socket;
- Elastic deformation of the drilled shaft.

The key aspect of the analysis is the computation of the  $t$ - $z$  responses of the socket layers. These predictions are based on theoretical models developed from observation of laboratory direct shear testing of concrete-rock interfaces under constant normal stiffness (CNS) conditions. Fundamental rock strength and deformation parameters, socket roughness data, and known stress conditions are required to make this prediction. The following input parameters are required:

- Drained shear strength parameters of the intact rock (cohesion and friction angle)
- Rock mass modulus and Poisson's ratio
- Socket dimensions and shaft modulus
- Initial normal stress and normal stiffness
- Mean height and length of asperities (socket roughness)

While some of the above parameters are determined on a routine basis for design of rock socketed foundations, asperity characteristics are not typically evaluated. However, the analysis provided by ROCKET can be used in conjunction with load testing and other prediction methods to evaluate key design parameters for rock sockets. Models of the concrete-rock interface incorporated into ROCKET are based predominantly on tests conducted on Melbourne mudstone, a relatively weak argillaceous rock. The authors caution that input values for rocks other than Melbourne mudstone be verified against other design methods or field load test results.

## D.5 SOFTWARE RESOURCES

The program TZPile analyzes the load-displacement behavior of deep foundations (piles and drilled shafts) by the  $t$ - $z$  curve method described above and is available from Ensoft, Inc., Austin, TX (<http://www.ensoftinc.com/>). The  $t$ - $z$  and  $q$ - $w$  curves can be generated internally based on the input of information on the supporting soil and on the geometry of the shaft, or the user can input their own curves.

The program SHAFT analyzes drilled shaft axial capacity and load-settlement response based on analytical methods given in the previous version of this manual (O'Neill and Reese, 1999). Load-settlement response under axial compression is based on normalized side and base resistance curves derived from field load tests. In this version of the manual, these curves have been replaced by a single normalized resistance curve shown in Figure 13-10. The updated figure (Figure 13-10) is more general and easier to apply for routine use; however, the predicted response is very close to that obtained from the earlier curves and from SHAFT. This program is also available from Ensoft, Inc.

Archived

This page is intentional left blank.



**APPENDIX E**

**AVAILABLE DRILLED SHAFTS  
LOAD TEST DATA**

Archived

Archived

This page is intentional left blank.

**APPENDIX E**  
**LIST OF AVAILABLE LOAD TEST DATA**

<b>Andalusia, Alabama</b>	<b>Test Shafts 1 &amp; 2</b>
<b>Blue Springs, Alabama</b>	<b>Test Shaft 1</b>
<b>Sumter County, Alabama</b>	<b>Test Shaft 1</b>
<b>Tuscaloosa, Alabama</b>	<b>Test Shaft 1</b>
<b>Wilcox County, Alabama</b>	<b>Test Shaft 1</b>
<b>Wilcox County, Alabama</b>	<b>Test Shaft 2</b>
<b>Benicia, California</b>	<b>Test Shaft 2</b>
<b>Coosa, Georgia</b>	<b>Test Shaft 2</b>
<b>Juliette, Georgia</b>	<b>Test Shaft 1</b>
<b>Keosauqua, Iowa</b>	<b>Test Shaft 1</b>
<b>Butler County, Kansas</b>	<b>Test Shaft 1</b>
<b>Clay County, Kansas</b>	<b>Test Shaft 1</b>
<b>Coffey County, Kansas</b>	<b>Test Shaft 1</b>
<b>Osborne County, Kansas</b>	<b>Test Shaft 1</b>
<b>Republic County, Kansas</b>	<b>Test Shaft 1</b>
<b>Republic County, Kansas</b>	<b>Test Shaft 2</b>
<b>Topeka, Kansas</b>	<b>Test Shaft 1</b>
<b>Minneapolis, Minnesota</b>	<b>Test Shaft 2</b>
<b>Leake County, Mississippi</b>	<b>Test Shaft 1</b>
<b>Lee County, Mississippi</b>	<b>Test Shaft 1</b>
<b>Madison County, Mississippi</b>	<b>Test Shaft 1</b>
<b>Oktibbeha County, Mississippi</b>	<b>Test Shaft 1</b>

<b>Oktibbeha County, Mississippi</b>	<b>Test Shaft 1</b>
<b>Oktibbeha County, Mississippi</b>	<b>Test Shaft 2</b>
<b>Perry County, Mississippi</b>	<b>Test Shaft 1</b>
<b>Pontotoc County, Mississippi</b>	<b>Test Shaft 1</b>
<b>Pontotoc County, Mississippi</b>	<b>Test Shaft 2</b>
<b>Dearborn, Missouri</b>	<b>Test Shaft 1</b>
<b>Columbus, Ohio</b>	<b>Test Shaft 1</b>
<b>Charleston, South Carolina</b>	<b>Test Shaft 1</b>
<b>Mount Pleasant/Charleston, South Carolina</b>	
<b>Mt. Pleasant, South Carolina</b>	<b>Test Shaft 1</b>
<b>Mt. Pleasant, South Carolina</b>	<b>Test Shaft 2</b>
<b>Nashville, Tennessee</b>	<b>Test Shaft 1</b>
<b>Dallas, Texas</b>	<b>Test Shaft 1</b>

Archived

Two dedicated test shafts were constructed in claystone. Each shaft had a 20-foot socket into the claystone with the tip of the shaft 76 feet below ground surface. Most of the strain gages did not survive the placement of the concrete. The shafts were tested using conventional methods.

### Test Shaft 1

#### Shaft Summary

Shaft Diameter (in)	Shaft Length (ft)	Socket Length (ft)	Max Net Load (kips)	Max Deflection Down (in)
28.0	76.0	20.0	690.00	0.13

#### Data Summary

Depth (ft)	Material	Average Unconfined Compressive Strength, $q_u$ (ksf)	Unit Side Shear (ksf)	Defl. For Side Shear (in)
0.0	Claystone	43.2	9.6	0.13

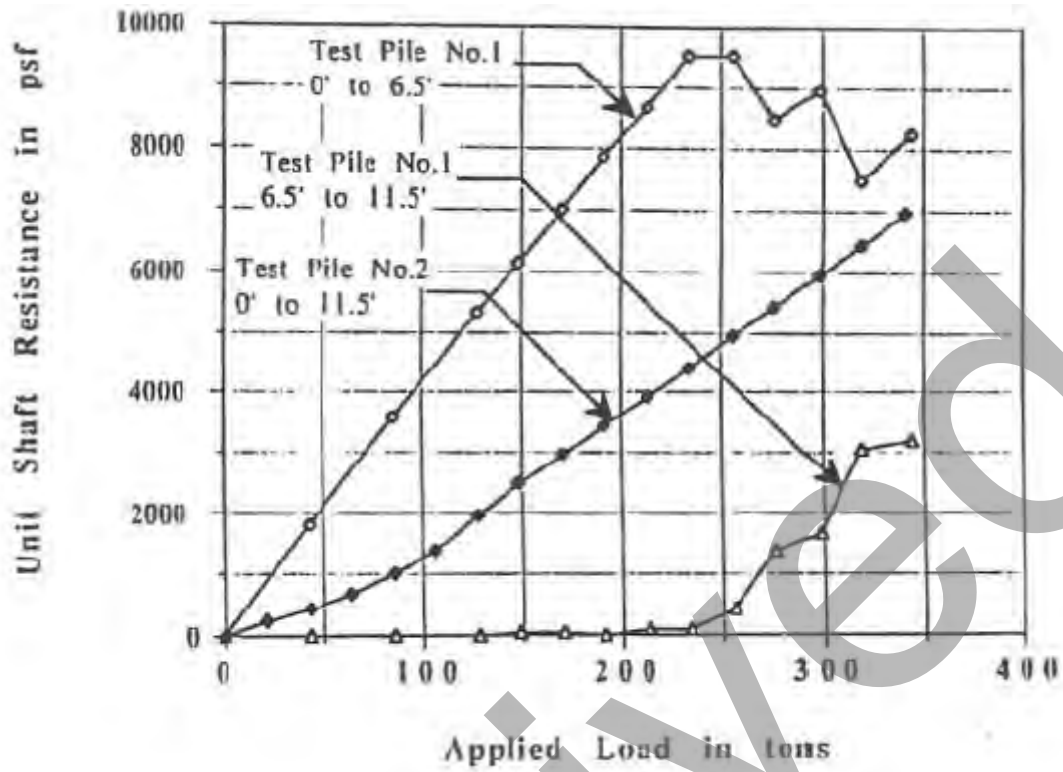
### Test Shaft 2

#### Shaft Summary

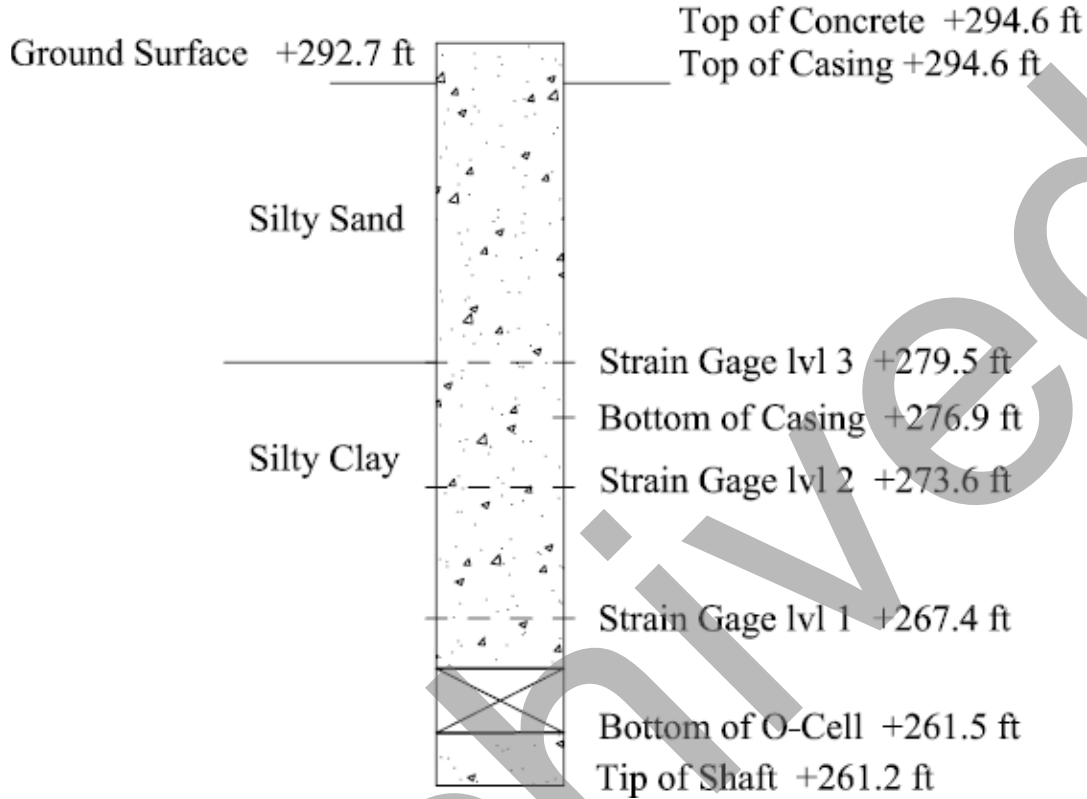
Shaft Diameter (in)	Shaft Length (ft)	Socket Length (ft)	Max Net Load (kips)	Max Deflection Down (in)
20.0	76.0	20.0	690.00	0.61

#### Data Summary

Depth (ft.)	Material	Average Unconfined Compressive Strength, $q_u$ (ksf)	Unit Side Shear (ksf)	Defl. For Side Shear (in)
0.0	Claystone	43.2	7	0.61



The test shaft was constructed on June 11, 1999. The 54-in test shaft was constructed dry with a total length of 33.3 feet. No unusual problems occurred during the construction of the test shaft.

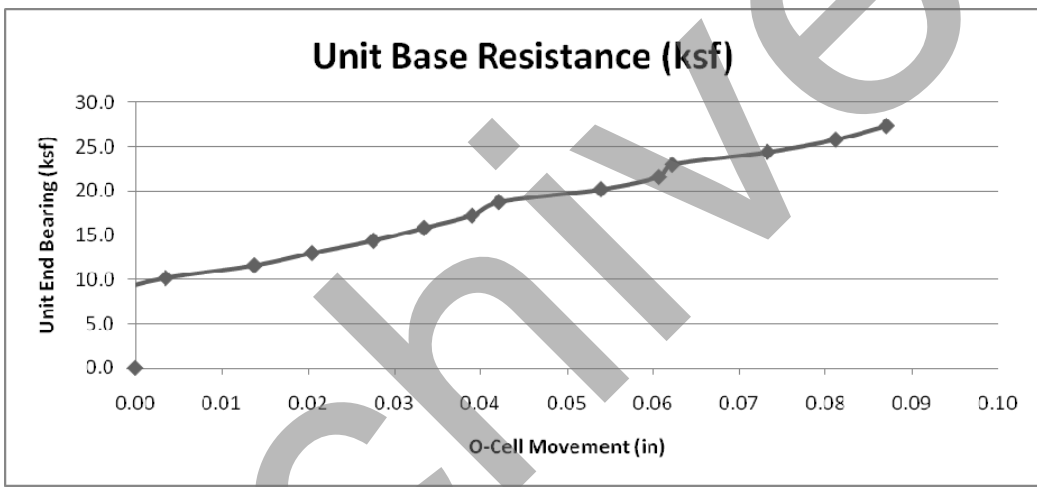
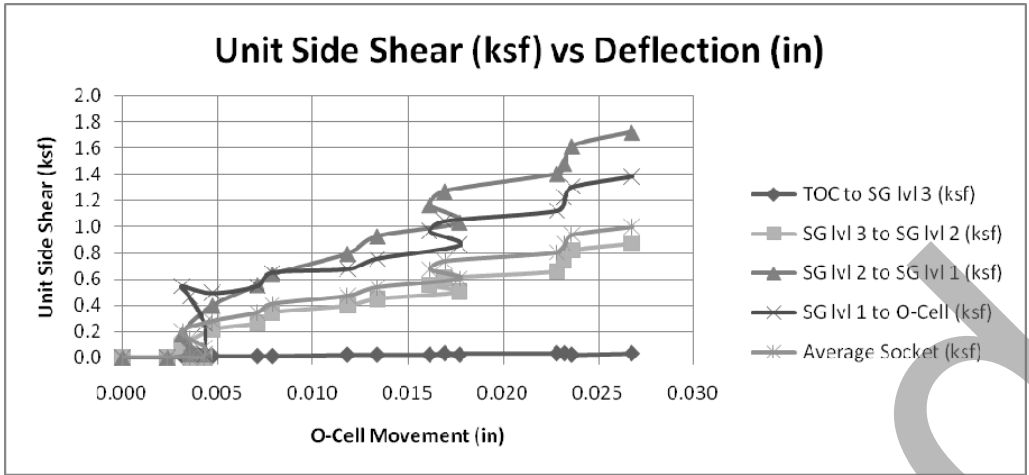


**Shaft Summary**

Shaft Diameter (in)	Shaft Length (ft)	Shaft Length Below O-cell (ft)	Shaft Length Above O-cell (ft)	O-cell Size (in)	Max Net Load (kips)	Max Deflection Up (in)
54.0	33.2	0.1	33.1	13.0	436.00	0.03

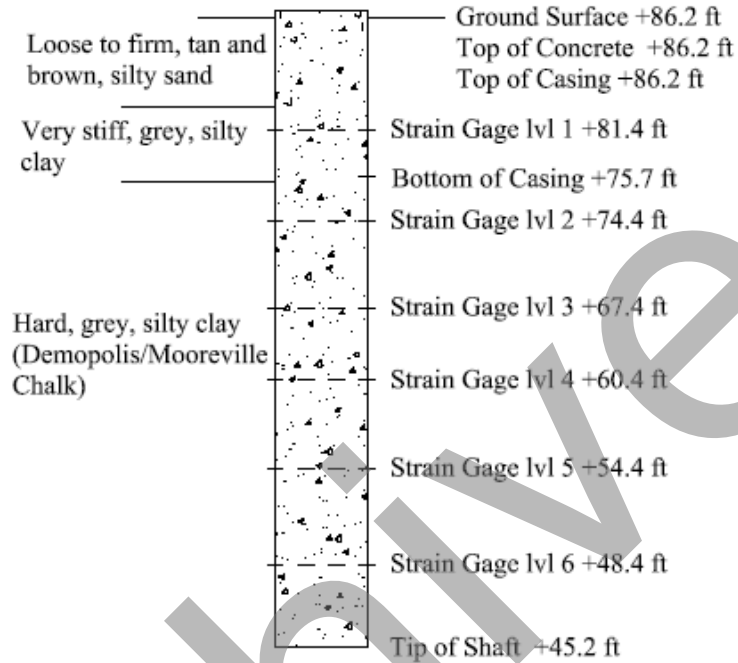
**Data Summary**

Elevation (ft.)	SPT "N" (Blows / ft)	Unit EB (ksf)	EB Deflection (in)	Unit SS (ksf)	SS Deflection (in)
294.6				0.03	0.027
279.5				0.88	
273.6	100			1.72	
267.4	100			1.39	
261.5	100				
261.2	100	27.4	0.087		





Statnamic axial and lateral load tests were performed on an 84-inch (7-foot) diameter, 41 foot long shaft. The upper 10.5 feet of shaft was permanently cased with a 90 inch outside diameter steel casing to isolate the shaft from the alluvial soils overlying the chalk of the Porters Creek and Clayton formations. The dedicated test shaft was constructed in the dry using an auger.



**Shaft Summary**

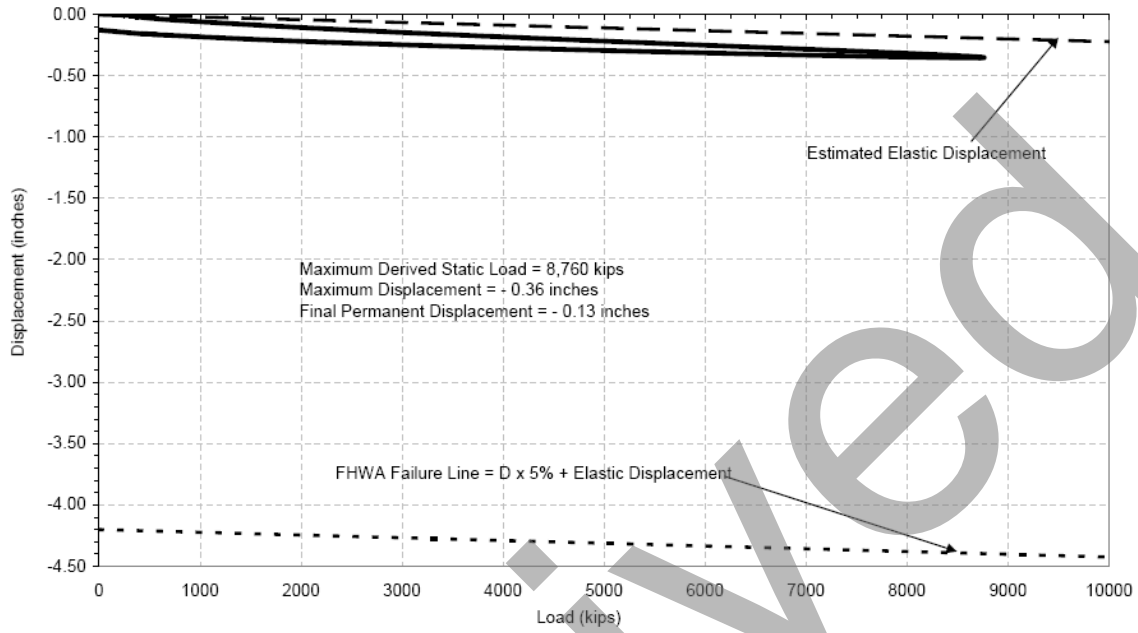
Shaft Diameter (in)	Shaft Length (ft)	Max Derived Static Load (kips)	Max Deflection (in)	Perm Deflection (in)
84 <sup>(a)</sup>	41.00	8760.0	0.36	0.13

**Data Summary**

Depth (ft.)	SPT "N" (Blows / ft)	Unit EB (ksf)	EB Deflection (in)	Unit SS (ksf)	SS Deflection (in)
86.2	5				
81.4	16			0	0.36
80.0	18				
75.0	50/3"				
74.4	50/3"			10.6	
67.4	50/3"			9.4	
60.4	50/3"			6.9	
54.4	50/3"			5.8	
48.4	50/3"			10.7	
45.2	50/3"	41.6	0.36		

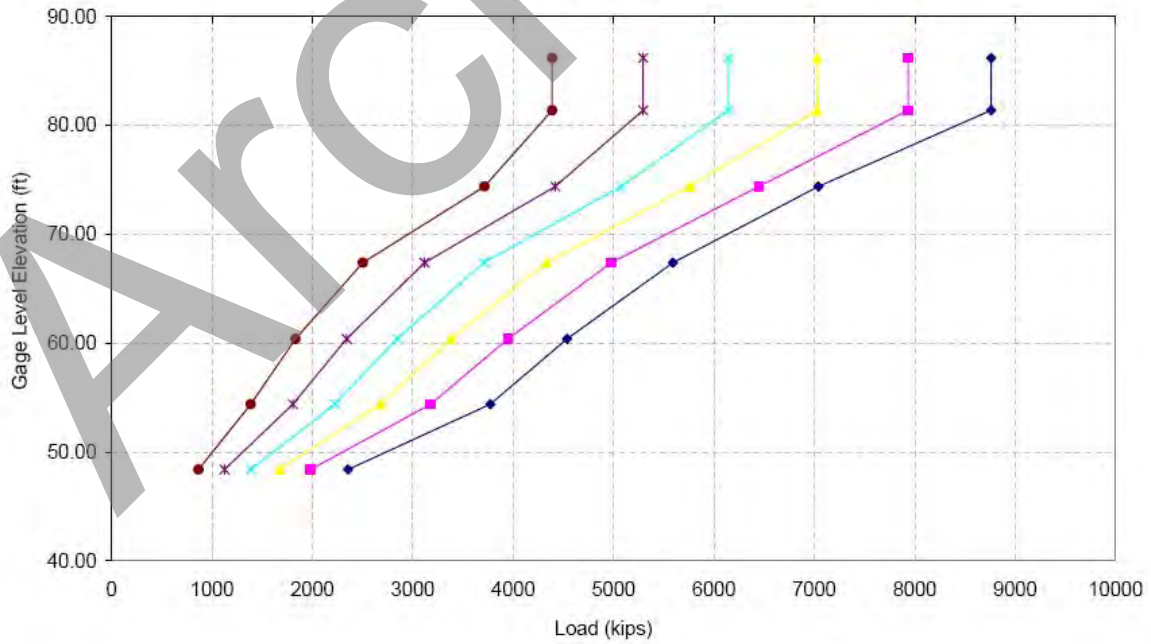
**Figure 1 - Load versus Displacement**

84-inch Diameter Test Shaft  
SR 8 from CR 71 to SR 28  
ALDOT Project No.: BRF-0008 (536)  
Sumter County, Alabama

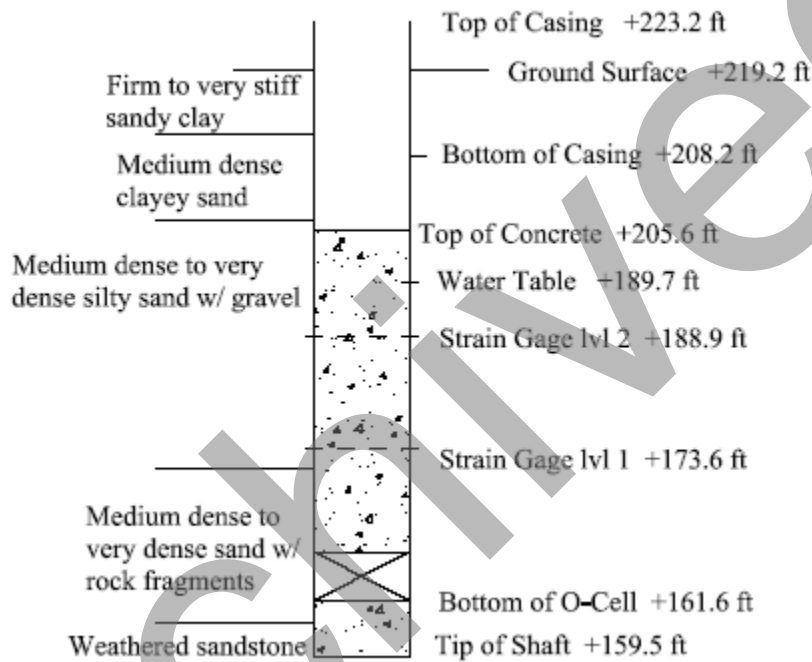


**Figure 2 - Load Transfer versus Elevation**

84-inch Diameter Test Shaft  
SR 8 from CR 71 to SR 28  
ALDOT Project No.: BRF-0008(536)  
Sumter County, Alabama



The test shaft was constructed on February 5, 2005. The shaft had a total length of 59.8 ft and was socketed into rock. The shaft was started with a 48-in O.D. temporary surface casing. The casing was inserted by pre-drilling. An auger was used for drilling the shaft. Polymer slurry was introduced into the excavation after casing insertion. The shaft was then drilled to a tip elevation of +159.5 ft under slurry. The shaft excavation was allowed to sit over night. On the following day, the bottom of the shaft was cleaned with a 40-in cleaning bucket. The concrete was placed in the base of the shaft by tremie pipe (which extended past the O-cell) until the top of the concrete reached the cut-off elevation. No unusual problems occurred during construction of the shaft.

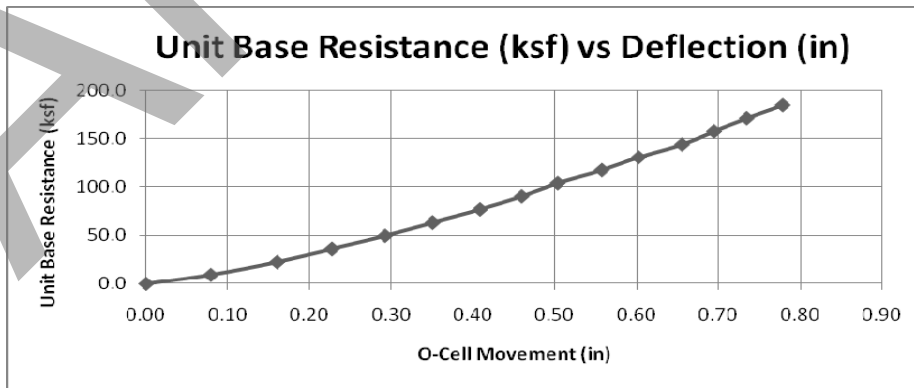
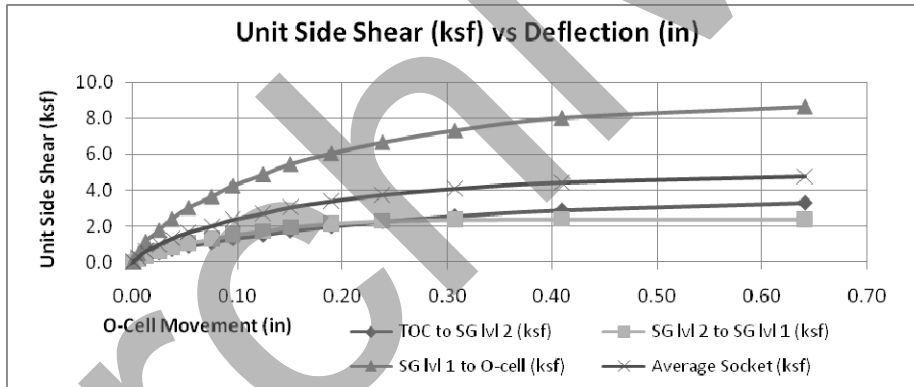


**Shaft Summary**

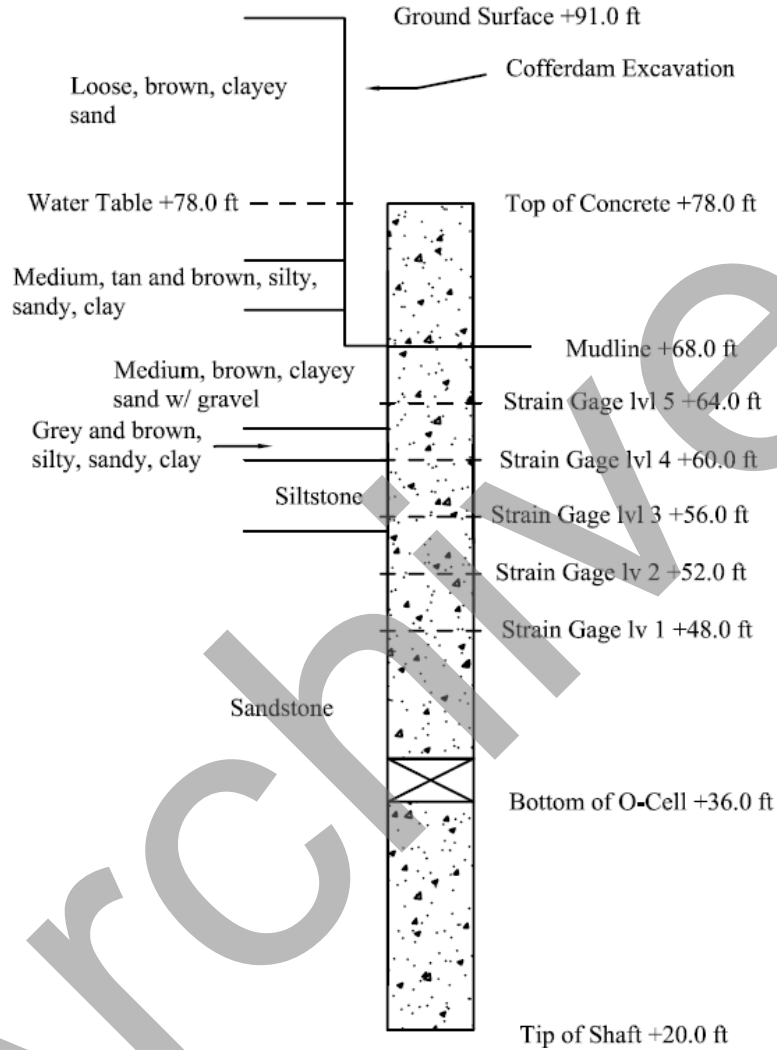
Shaft Diameter (in)	Shaft Length (ft)	Shaft Length Below O-cell (ft)	O-cell Size (in)	Max Net Load (kips)	SS Creep Load (kips)	EB Creep Load (kips)
48.0	59.7	2.1	21.0	2515.0	1400.00	not reached

**Data Summary**

Elevation (ft.)	SPT "N" (Blows / ft)	Rock Core Recovery (%)	Rock Core RQD	Unit EB (ksf)	EB Deflection (in)	Unit SS (ksf)	SS Deflection (in)
219.2							
208.2							
205.6						3.16	
188.9	26.0						
183.0	46.0						
178.0	22.0					2.29	
173.6	7.0						0.64
169.0	23.0						
164.0	21.0					8.96	
161.6							
160.0		50	0				
159.5				181.5	0.78		
157.0		47	0				
155.0		88	70				
150.0		100	97				



The test shaft was constructed on March 6, 1996 while the load test was carried out on March 21, 1996. The 48-in test shaft was constructed wet, with water, using a continuously advanced casing to a total shaft length of 58.0 ft. The O-cell was located 16.0 ft above the tip of the shaft. No unusual problems occurred during the construction of the shaft.

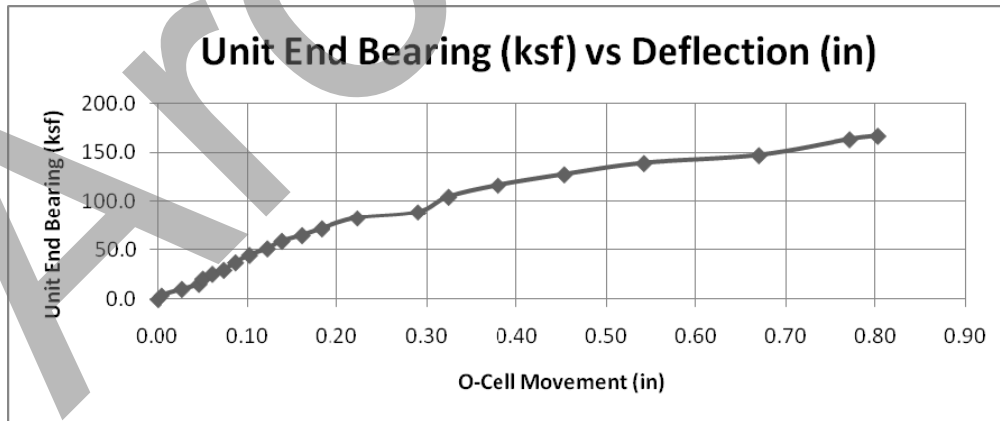
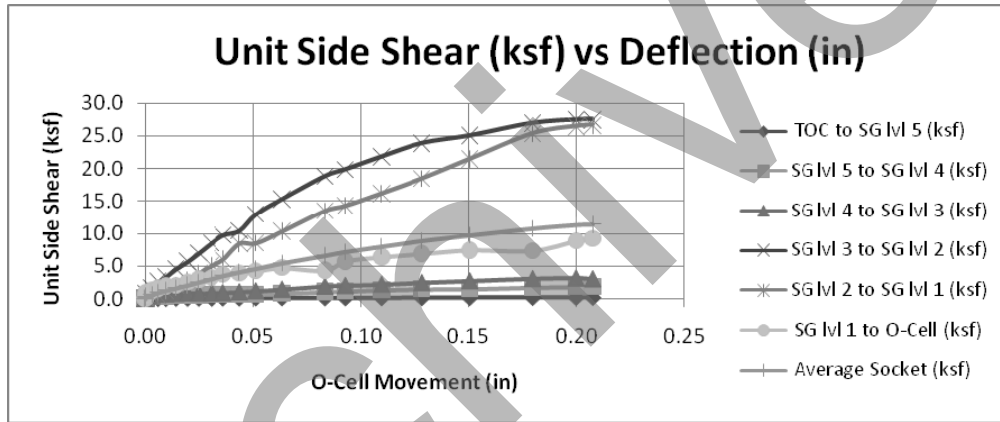


**Shaft Summary**

Shaft Diameter (in)	Shaft Length (ft)	Shaft Length Below O-cell (ft)	Shaft Length Above O-cell (ft)	O-cell Size (in)	Max Net Load (kips)	Max Deflection Up (in)
48.0	58.0	16.0	42.0	34.0	4394.00	0.21

**Data Summary**

Elevation (ft.)	Average $q_u$ (ksf)	Unit EB(ksf)	EB Deflection (in)	Unit SS (ksf)	SS Deflection (in)
78.0					
68.0				0.68	0.21
64.0				1.86	
61.0	130.4			3.04	
60.0				27.52	
58.0	97.6			26.70	
56.0				9.20	
55.0	70.3				
52.0					
48.0					
36.0					
20.0		202.00	0.8		

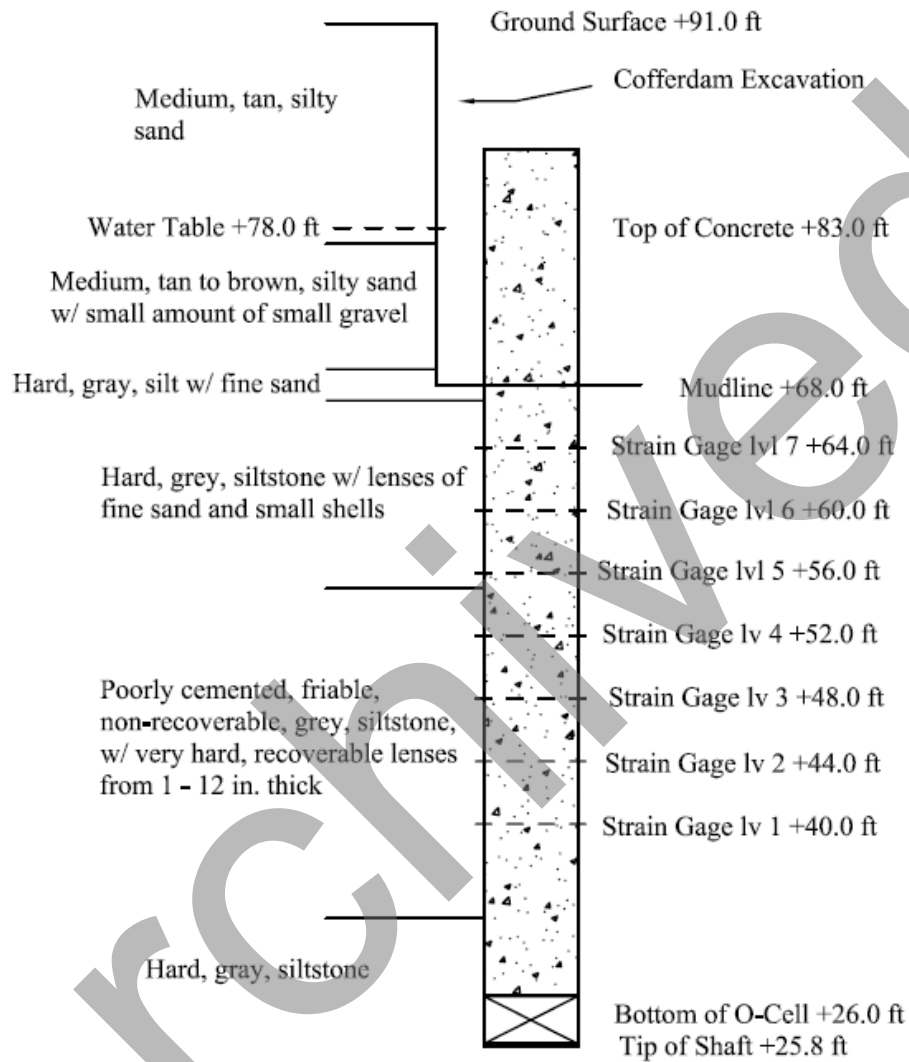


SR 28 over Alabama River

Wilcox County, Alabama

Test Shaft 2

The test shaft was constructed on March 10, 1996 while the load test was carried out on March 26, 1996. The 48-in test shaft was constructed wet, with water, using a continuously advanced casing to a total shaft length of 57.2 ft. The O-cell was located 0.2 ft above the tip of the shaft. No unusual problems occurred during the construction of the shaft.

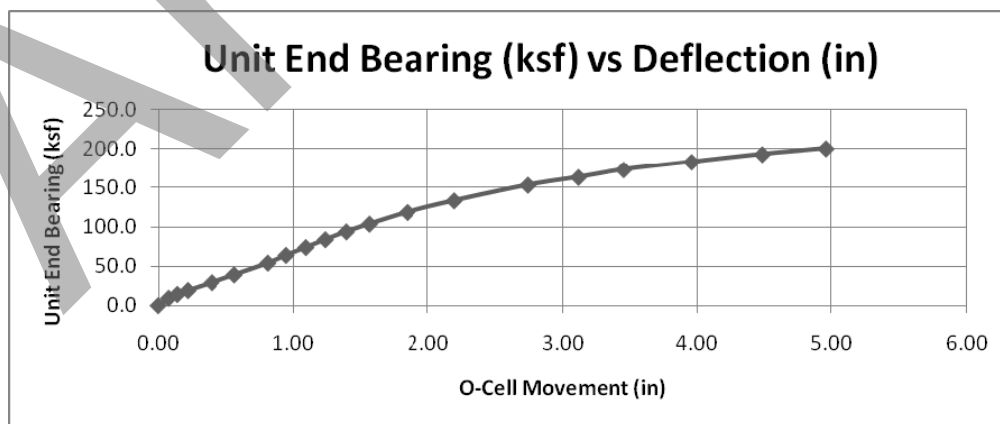
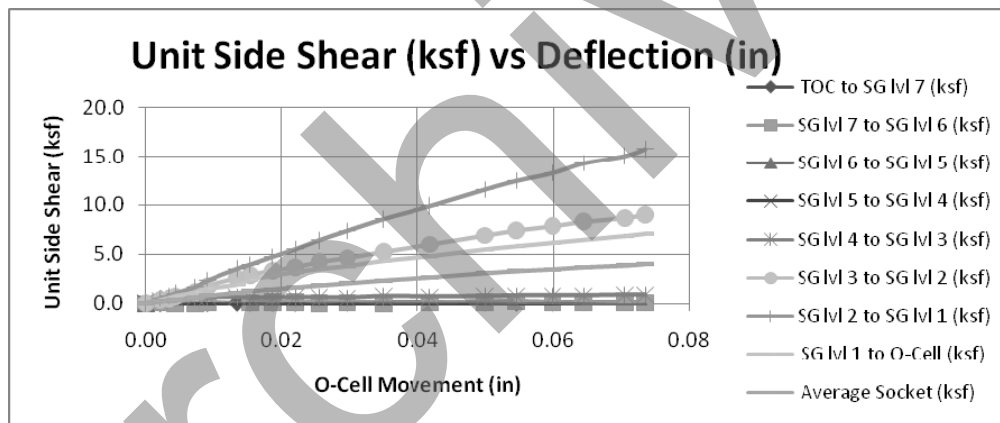


**Shaft Summary**

Shaft Diameter (in)	Shaft Length (ft)	Shaft Length Below O-cell (ft)	Shaft Length Above O-cell (ft)	O-cell Size (in)	Max Net Load (kips)	Max Deflection Up (in)
48.0	57.2	0.2	57.0	34.0	2532.00	0.07

**Data Summary**

Elevation (ft.)	Average $q_u$ (ksf)	Unit EB (ksf)	EB Deflection (in)	Unit SS (ksf)	SS Deflection (in)
83.0					0.07
68.0				-----	
66.0	144.0				
64.0				-----	
62.0	81.9				
60.0				-----	
58.0	158.0				
56.0	133.5			-----	
52.0					
50.0	630.9			0.82	
48.0				9.06	
44.0				15.78	
40.0				7.06	
33.0	454.5				
26.0					
25.8		200	4.96		



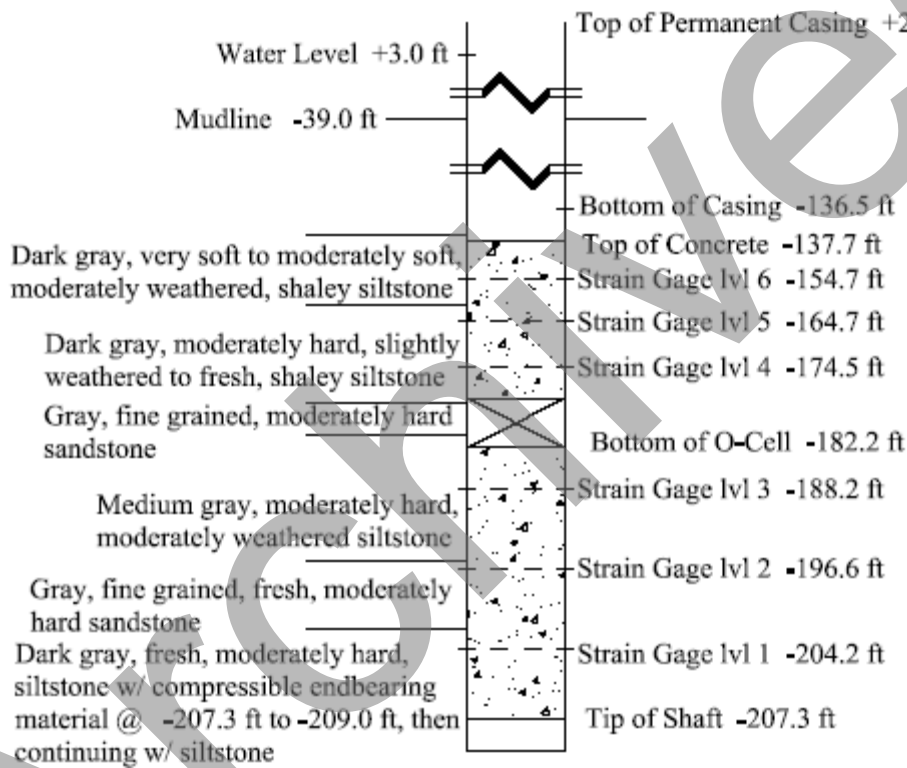
Benicia Martinez Bridge

Benicia, California

Test Shaft 2



The test shaft was constructed on December 9, 1999. The dedicated test shaft was constructed wet using bay water and cased with a 72-in O.D. casing down to elevation -136.5 ft. The remainder of the shaft, down to elevation -207.3 ft, was drilled at 66-in diameter. After drilling, the shaft was cleaned by air lifting. The O-Cell assembly was then inserted and concrete was placed using a 10.75-in tremie pipe. No unusual problems occurred during the construction of the test shaft. Note: Compressible end bearing material was attached to the tip of the shaft in order to prevent any of the load being transferred to end bearing. The compressible end bearing material consisted of a foam cylinder with a hydraulic jack in the center. On the outside of the foam cylinder were two levels of expandable bladders. Once the O-Cell assembly was positioned in the shaft, the hydraulic jack was pressurized to support the weight of the shaft while the concrete was placed. The bladders were expanded with water and brought into contact with the walls of the shaft to prevent grout from entering the zone of compressible end bearing material. The jack and bladders were depressurized after the concrete had sufficiently cured.

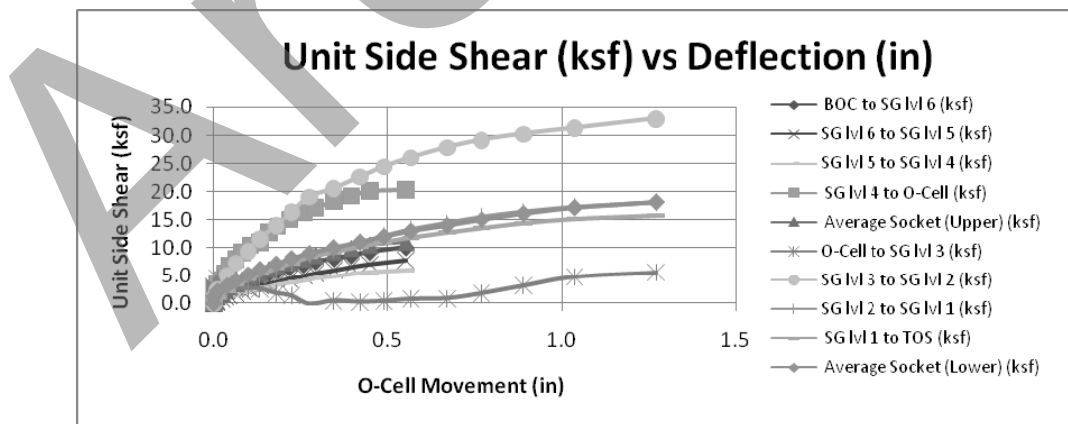


### Shaft Summary

Shaft Diameter (El. +20.0 to -136.5) (in)	Shaft Diameter (El. -136.5 to -207.3) (in)	Shaft Length (ft)	Shaft Length Below O-cell (ft)	O-cell Size (in)	Max Net Load (kips)	SS Creep Load (kips)	EB Creep Load (kips)
72.0	66.0	168.3	25.1	21.0	9259.0	0.0	N/A

**Data Summary**

Elevation (ft.)	Average $q_u$ (ksf)	RQD (%)	Rock Core Recovery (%)	Unit EB (ksf)	EB Deflection (in)	Net Unit SS (ksf)	SS Deflection (in)
+20.0							
-39.0							
-72.2	0.23						
-78.7	0.46						
-95.1	2.51						
-101.7	2.01						
-108.3	1.61						
-136.5							0.55
-137.7						10.06	
-154.7							
-160.8	85.9	100.0	104	N/A	N/A	7.75	
-164.7						5.98	
-174.5							
-180.5	118.9	74.0	100			20.38	
-182.2							
-188.2						5.53	
-193.6	128.7	100.0	100			33.01	1.27
-196.6						18.08	
-204.2							
-207.3						15.74	

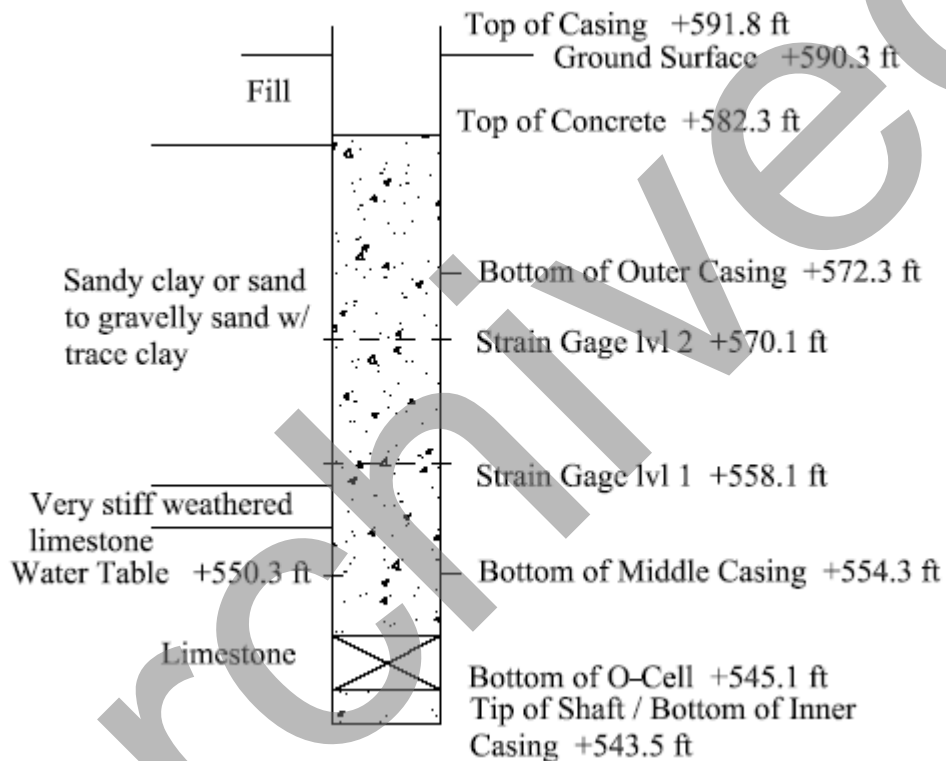


Plant Hammond

Coosa, Georgia

Test Shaft 2

Excavation for the test shaft began on February 9, 2006 and the final cleanout was performed on February 14, 2006. The 48-in test shaft was excavated to a tip elevation of +543.5 ft, under water. The shaft was started by installing a 60-in O.D. temporary surface casing and a 54-in O.D. temporary middle casing was advanced to the top of rock as the drilling progressed using an auger. A 48-in core barrel was used for drilling the rock. After reaching tip, a 48-in O.D. temporary casing was placed into the completed excavation and allowed to rest on the shaft bottom. After cleaning the base with a cleanout bucket, the 54-in O.D. middle casing was removed. The carrying frame with attached O-cell assembly was then inserted into the excavation concurrent with the tremie pipe placement. Concrete was then delivered by pump through a pipe into the base of the shaft. As concrete placement proceeded, the inner 48-in casing was removed gradually. No unusual problems occurred during the construction of the test shaft.

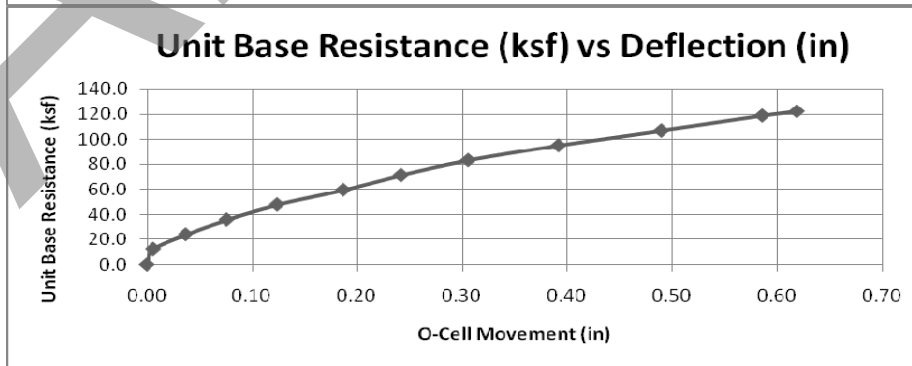
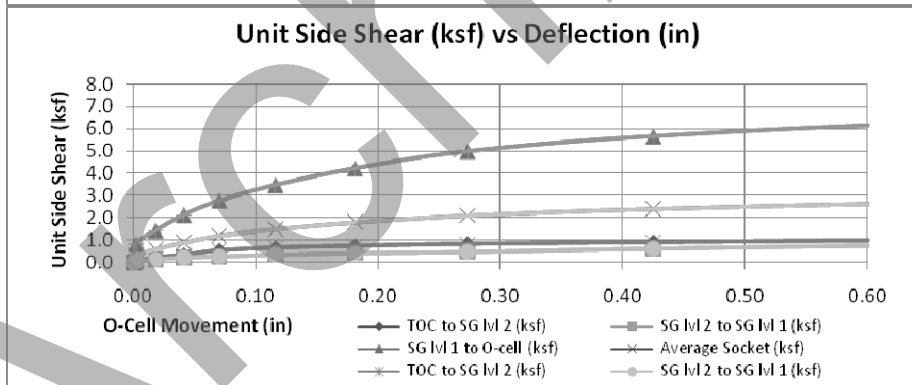
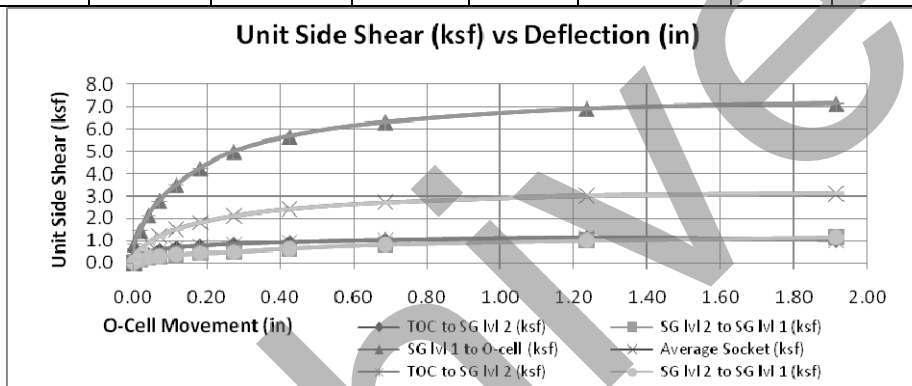


**Shaft Summary**

Shaft Diameter (in)	Shaft Length (ft)	Shaft Length Below O-cell (ft)	O-cell Size (in)	Max Net Load (kips)	SS Creep Load (kips)	EB Creep Load (kips)
48.0	46.8	1.6	21.0	1599.0	1100.0	1243.0

**Data Summary**

Elevation (ft.)	SPT "N" (Blows / ft)	Rock Core Recovery (%)	Rock Core RQD	Unit EB (ksf)	EB Deflection (in)	Unit SS (ksf)	SS Deflection (in)
590.3							
582.3						0.9	1.92
575.0	30.0						
572.3							
570.1	24.0						
565.0	11.0					1	
558.1	14.0						
554.3	Refusal						
550.0		75	15			8.3	
545.1		53	47	115.3	0.62		
543.5							

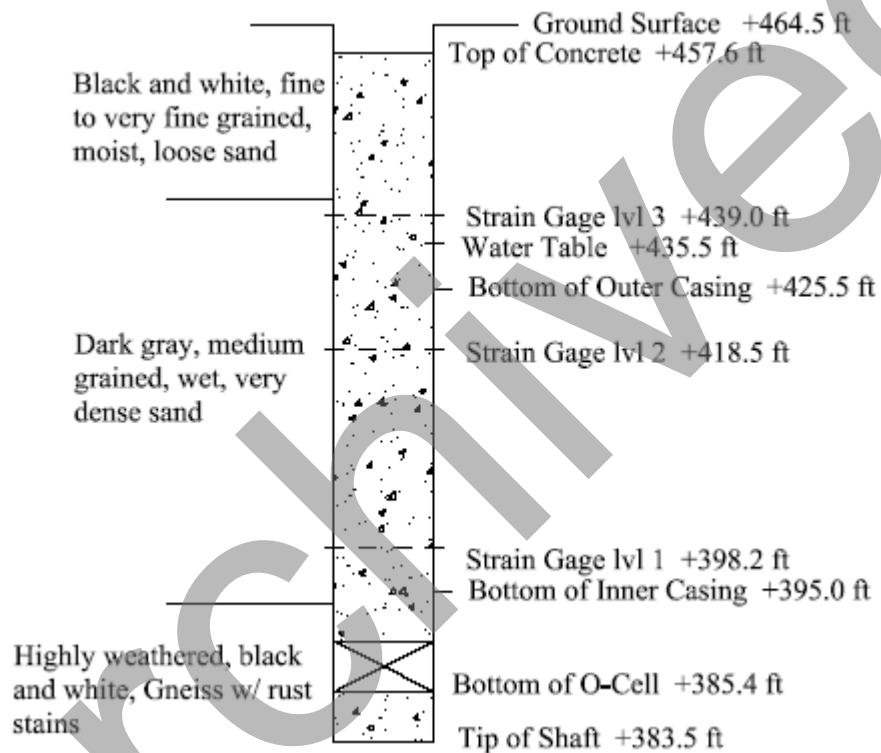


Georgia Power - Plant Scherer

Juliette, Georgia

Test Shaft 1

Construction started on the dedicated test shaft on January 22, 2008 and was completed on January 25, 2008. The test shaft was excavated to a tip elevation of +383.5 ft under natural groundwater seepage. The shaft was started by pre-drilling and installing an outer 72-in O.D. casing to an elevation of +425.5 ft. An inner 66-in O.D. casing was inserted as the drilling progressed into the top of rock. An auger and a bucket were used for drilling the shaft. After cleaning the base with a cleanout bucket, the carrying frame with attached O-cell assembly was inserted into the excavation and temporarily supported from the outer steel casing. Concrete was then delivered by pump through a 5-in O.D. pipe into the base of the shaft until the top of the concrete approached the top of the inner casing. The contractor partially extracted the inner 66-in casing and charged it full of concrete. The outer 72-in casing was then fully removed from the excavation. Immediately after placing additional concrete into the inner casing, it was subsequently extracted. No unusual problems occurred during construction of the shaft.

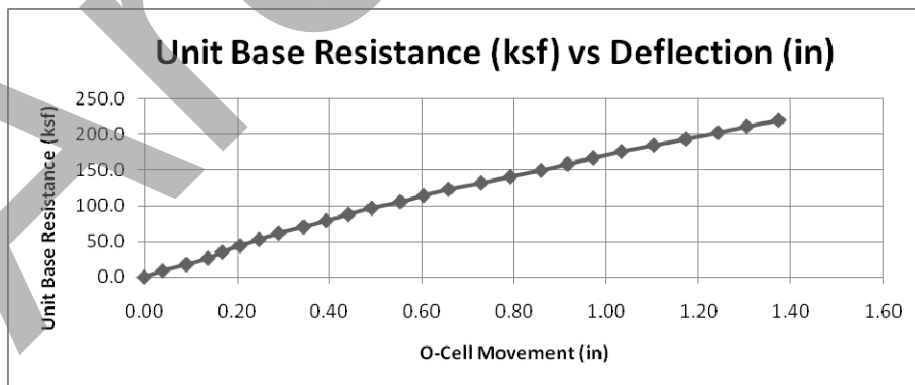
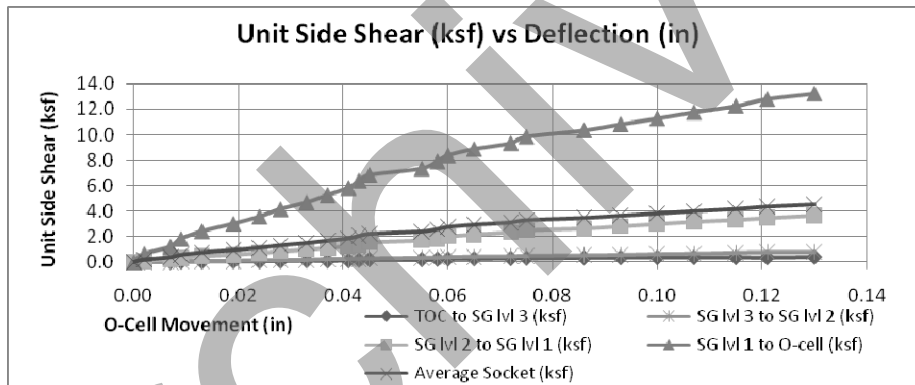


**Shaft Summary**

Shaft Diameter (Elev. 425.5 - 395.0)(in)	Shaft Diameter (Elev. 395.0 - 385.4)(in)	Shaft Length (ft)	Length Below O-cell (ft)	O-cell Size (in)	Max Net Load (kips)	SS Creep Load (kips)	EB Creep Load (kips)
66.0	60.0	81.0	1.9	26.0	4278.0	not reached	not reached

**Data Summary**

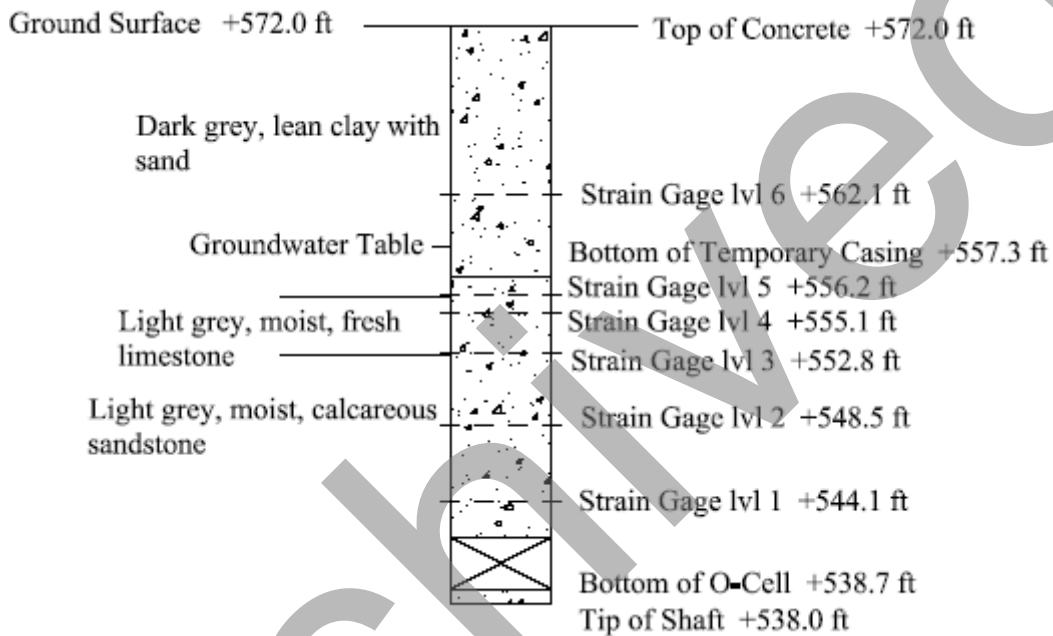
Elevation (ft.)	SPT "N" (Blows / ft)	Rock Core Recovery (%)	Rock Core RQD	Unit EB (ksf)	EB Deflection (in)	Unit SS (ksf)	SS Deflection (in)
464.5							
457.6							
454.5	3.0					0.1	0.12
450.5	30.0						
445.5	49.0						
439.0	100+						
425.5						0.6	
418.5						3.7	
398.2						16.7	
395.0							
385.4	100+			193.4	1.30		
383.5							
380.5		19	0				
375.5		17	12				



Hwy 1 over Des Moines River Keosauqua, Iowa

Test Shaft 1

The dedicated test shaft was constructed between May 1, 2006 and May 3, 2006. The 36-in test shaft was excavated wet to a tip elevation of +538.0 ft with polymer slurry. The shaft was started by predrilling the overburden and screwing in a temporary casing. The rock was cored and occasionally drilled with a rock auger. The final tip elevation was drilled with the auger and cleaned with a cleanout bucket. Prior to concrete placement, the base of the shaft was airlifted. Approximately 2 linear feet of grout was placed in the base of the shaft by pump line. After extracting the pump line, the rebar cage with attached O-cell assembly was inserted and allowed to settle into the wet grout with the O-cell 0.7 ft above the center of the shaft tip. The casing was charged with concrete and then fully extracted. No unusual problems occurred during the construction of the drilled shaft.

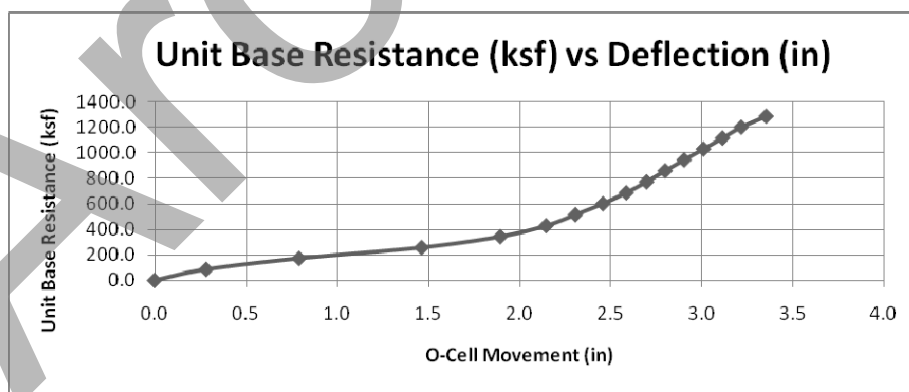
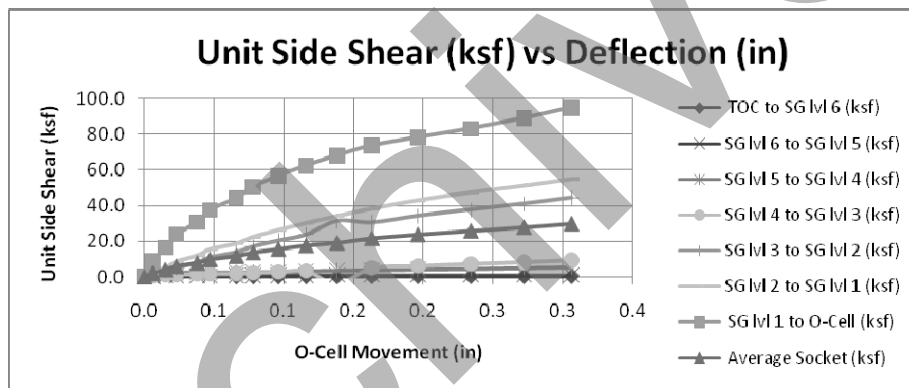


### Shaft Summary

Shaft Diameter (El. +572.0 - +557.3) (in)	Shaft Diameter (El. +557.3 - 538.0) (in)	Shaft Length (ft)	Shaft Length Below O-cell (ft)	Shaft Length Above O-cell (ft)	O-cell Size (in)	Max Net Load (kips)
42.0	36.0	34.0	0.7	33.3	34.0	18517.0

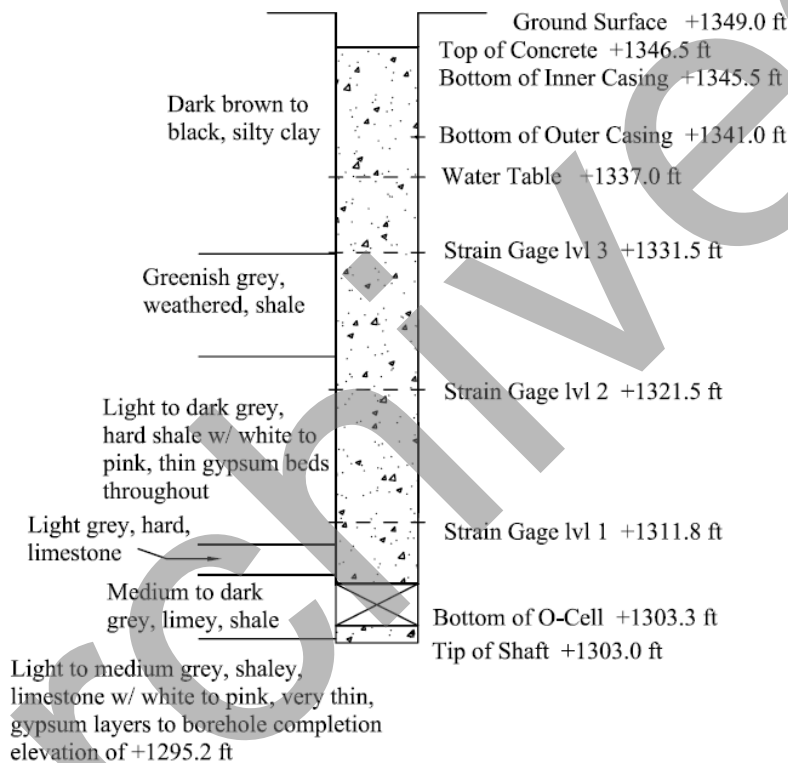
### Data Summary

Elevation (ft.)	SPT "N" (Blows / ft)	Average $q_u$ (ksf)	Rock Core Recovery (%)	Rock Core RQD	Unit EB (ksf)	EB Deflection (in)	Unit SS (ksf)	SS Deflection (in)
569.1								0.31
566.1	20						0.1	
562.1	11							
560.1	9						0.9	
556.1	50/2"	555.8	92	0.79				
554.1		1388.2	92	0.79			5.3	
552.8							9.2	
549.1		862.6	100	0.83			44.3	
545.1		1147.7	108	0.93			55.0	
539.1		889.4	108	1.02	1312.00	3.35	120.8	
535.1		557.3	95	0.92				
529.1			88	0.37				
524.1		725.8	95	0.98				
522.1								





The dedicated test shaft socketed in shale and limestone was constructed on July 10, 2003. The 48-in test shaft was constructed dry to a total depth of 46.0 ft. The shaft was started by inserting a 60-in O.D. surface casing and drilling with an auger to its tip at a depth of 6.0 ft from existing ground surface. A 54-in O.D. casing was then inserted and drilled to its tip at a depth of 25.5 ft. A rock auger and a cleanout bucket were then used for drilling the 48-in diameter, 20.5 ft long rock socket and cleaning the base. After cleaning the base, approximately 2.5 linear feet of concrete was placed using a cleanout bucket, and the reinforcing cage with attached O-cell assembly was inserted into the excavation and into the wet concrete and temporarily supported by a crane. Concrete was then delivered by pump through a tremie pipe into the existing wet concrete at the base of the shaft until the top of the concrete reached an elevation of +1346.5 ft. Both the inner and outer temporary casings were removed immediately after concrete placement was completed. No unusual problems occurred during construction of the shaft.

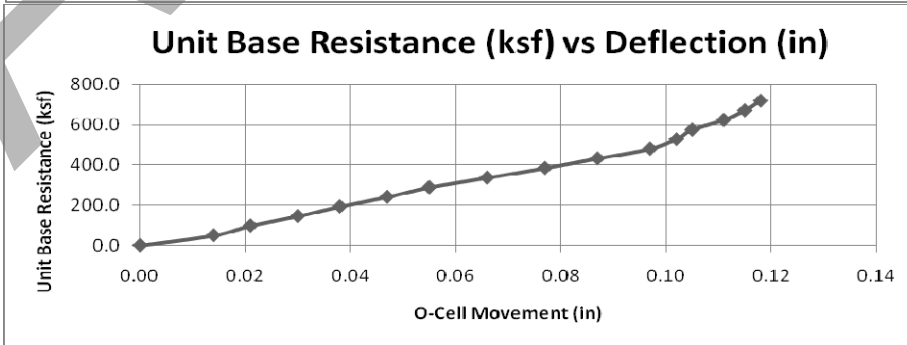
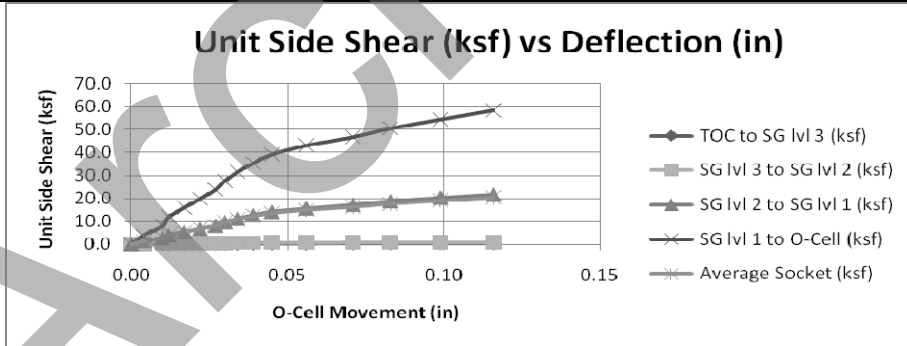


**Shaft Summary**

Shaft Diameter (in)	Shaft Length (ft)	Shaft Length Below O-cell (ft)	Shaft Length Above O-cell (ft)	O-cell Size (in)	Max Net Load (kips)	Max Deflection Up (in)
48.0	46.0	0.3	43.2	34.0	9121.80	0.12

**Data Summary**

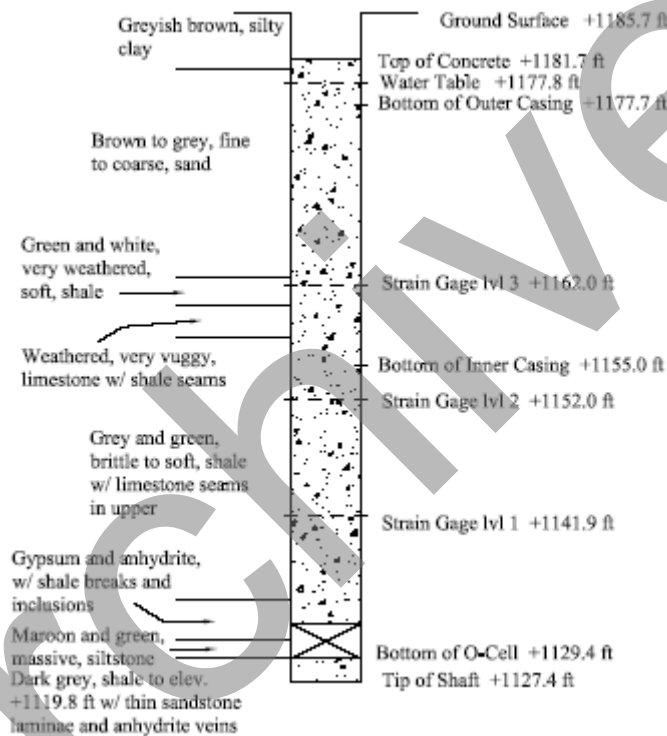
Elevation (ft.)	Average $q_u$ (ksf)	Rock Core Recovery (%)	Rock Core RQD	Unit EB (ksf)	EB Deflection (in)	Unit SS (ksf)	SS Deflection (in)
1349.0							
1346.5						0.3	0.12
1342.5	1.4						
1337.5	1.8						
1332.5	1.0						
1331.5						0.8	
1323.9							
1321.5						21.6	
1317.7	125.5	100	68				
1315.6	230.8	100	68				
1314.3	416.6	100	68				
1311.8						58.4	
1310.2							
1308.2	635.8	98	100				
1308.0							
1306.0	382.6	98	100				
1304.3	507.7	102	100				
1303.3							
1303.0				708.4	0.12		
1300.9	546.7	102	100				
1298.6	408.8	100	100				
1297.5	267.5	100	100				
1295.2	693.0	100	100				



US 24 over Republican River Clay County, Kansas

Test Shaft 1

The dedicated test shaft socketed in shale was constructed on March 27, 2003. The 48-in test shaft was excavated to a tip elevation of +1127.4 ft. The overburden was excavated under polymer slurry. A 60-in O.D., 8-ft long outer surface casing was used during the overburden excavation. A 54-in O.D., 30-ft long inner casing was inserted into the shaft excavation and screwed into the top of rock. The polymer was then removed from the hole and the shale was excavated in the dry until reaching the tip. The hole was then flooded with river water due to excessive ground water seepage into the hole. An auger and a mud bucket were used for drilling and cleaning the shaft. After cleaning the base, the carrying frame with attached O-cell assembly was inserted into the excavation and temporarily supported by the support crane. Concrete was then delivered by pump through a 5-in pipe into the base of the shaft until the top of the concrete reached an elevation of +1187.7 ft. The temporary inner casing was removed immediately after concrete placement. The outer surface casing was partially extracted after concreting and then fully removed prior to the start of the load test. No unusual problems occurred during construction of the shaft.

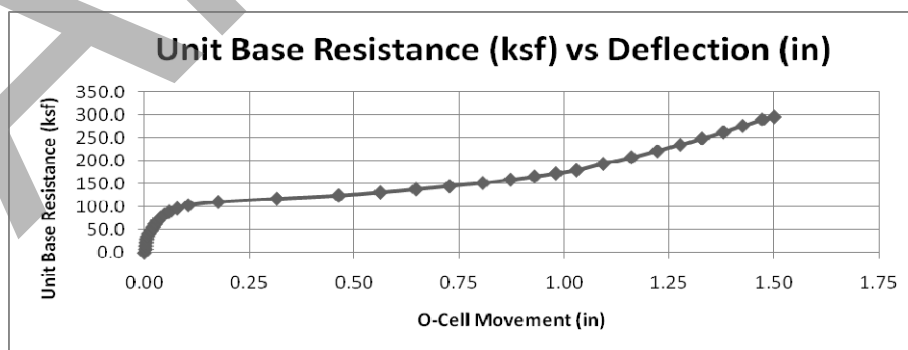
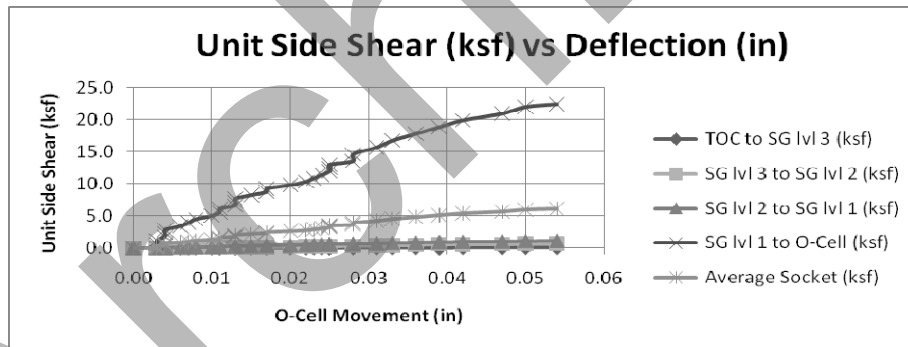


### Shaft Summary

Shaft Diameter (in)	Shaft Length (ft)	Shaft Length Below O-cell (ft)	Shaft Length Above O-cell (ft)	O-cell Size (in)	Max Net Load (kips)	SS Creep Load (kips)	EB Creep Load (kips)
48.0	58.3	2.0	56.3	21.3	3859.10	0.00	1350.00

### Data Summary

Elevation (ft.)	Average $q_u$ (ksf)	Rock Core Recovery (%)	Rock Core RQD	Unit EB (ksf)	EB Deflection (in)	Unit SS (ksf)	SS Deflection (in)
1185.7							
1183.9	3.9						
1181.7						0	0.06
1162.0						0.6	
1156.1	12.3	53	25				
1152.0						1.0	
1149.8	4.8	67	68				
1145.3	1.8	74	36				
1144.9	3.2	74	36				
1141.9						22.7	
1138.2	8.2	101	54				
1130.7	294.6	99	70				
1127.4				207	1.51		
1122.9	388.6	102	92				
1121.1	11.0	102	92				
1119.2	46.7	99	80				
1117.4	318.6	99	80				
1115.2	359.2	82	38				
1112.6	243.5	82	38				
1109.3	542.0	86	63				
1107.6	1016.5	86	63				

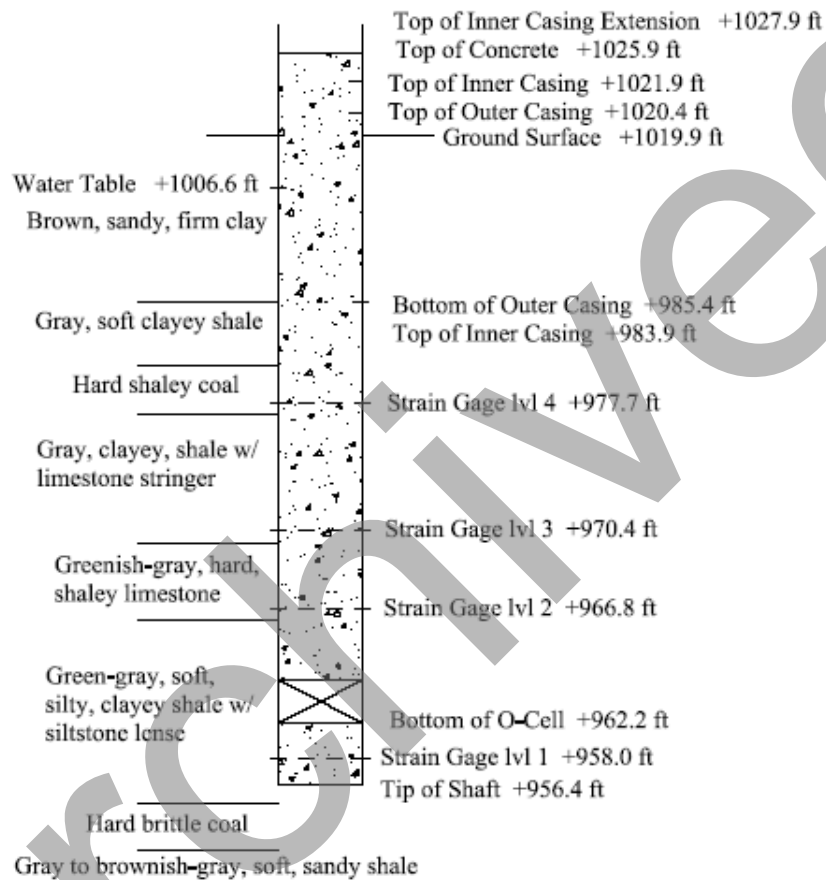


US 75 over Neosho River

Coffey County, Kansas

Test Shaft 1

The 63.5 ft deep dedicated test shaft was constructed in the dry on April 14, 2004. Excavation proceeded by pre-drilling with an auger and inserting a 66-in O.D. casing, screwed into the top of shale. An inner 60.8-in O.D. casing was then inserted and screwed into the shale with its tip located approximately 1.5 ft below the tip of the outer casing. Following insertion of the inner casing, the shaft was flooded with river water to simulate a wet concrete pour condition. The shaft bottom was cleaned with a clean-out bucket. After base cleaning and installation of the carrying frame and O-cell assemble, concrete was pumped into the base of the shaft through a tremie pipe until reaching the planned top of concrete elevation. No unusual problems occurred during test shaft construction.

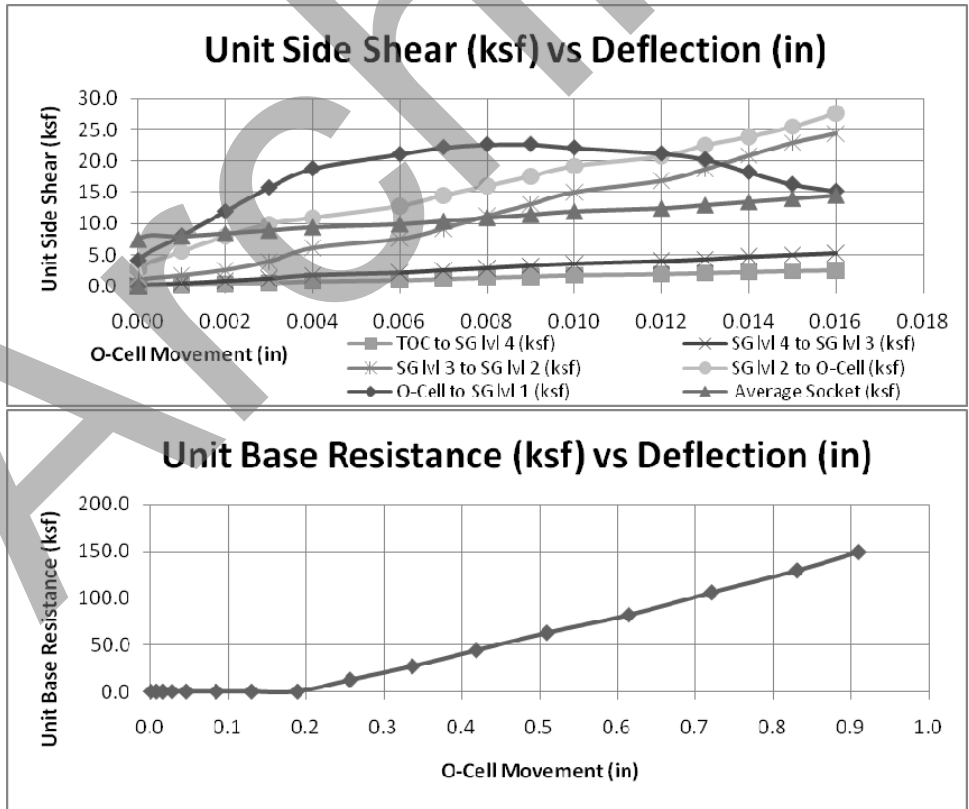


**Shaft Summary**

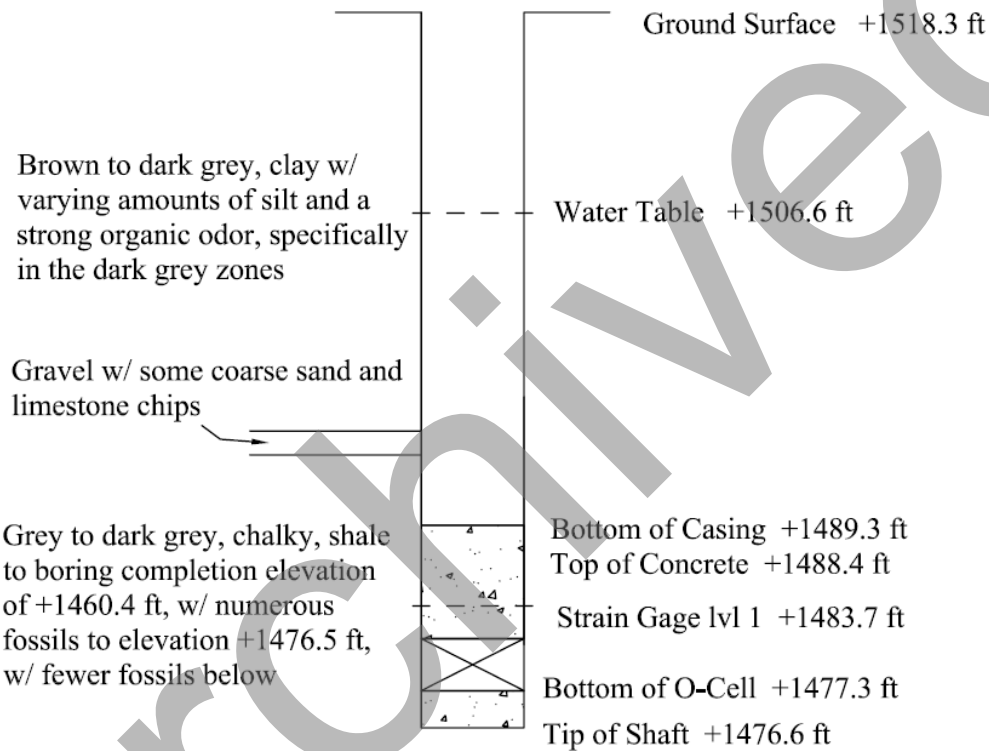
Shaft Diameter (El. +1020.4 - +985.4) (in)	Shaft Diameter (El. +985.4 - +956.4) (in)	Shaft Length (ft)	Shaft Length Below O-cell (ft)	O-cell Size (in)	Max Net Load (kips)	SS Creep Load (kips)	EB Creep Load (kips)
66.0	60.0	69.5	5.8	26.0	4304.0	1050.0	940.0

**Data Summary**

Elevation (ft.)	Average $q_u$ (ksf)	Unit EB (ksf)	EB Deflection (in)	Unit SS (ksf)	SS Deflection (in)
1027.9					
1025.9					0.02
1017.1	5.2				
1019.9					
1014.5	12.3				
985.4				1.61	
983.9					
977.7	16.5				
975.4	7.1			5.20	
972.4	9.8				
970.4					
968.8	444.8			24.31	
967.9	1714.6				
966.8				27.62	
962.2	7.3			15.19	
958.0					
956.4		149.0	0.91		
954.2	56.4				
945.7	152.4				
942.9	112.8				



The dedicated test shaft was constructed on September 25, 2001 while the load test was carried out on October 3, 2001. The 42-in test shaft was constructed wet, using water to a total depth of 41.7 ft. Polymer was added to the drilling fluid when the sand layer was encountered. The shaft was pre-drilled 27 feet with a soil auger and a 48-inch O.D. casing was inserted as the drilling progressed and was screwed into competent rock. A rock auger was then used for drilling the rock socket and the bottom of the shaft was cleaned with a cleanout bucket after drilling. After the carrying frame and O-cell assembly was inserted into the shaft, concrete was placed on by pump through a 4-inch O.D. pipe into the base of the shaft until the top of the concrete reached an elevation of +1488.4 feet. No unusual problems occurred during construction of the shaft. The O-cell was located 0.7 feet above the tip of shaft.

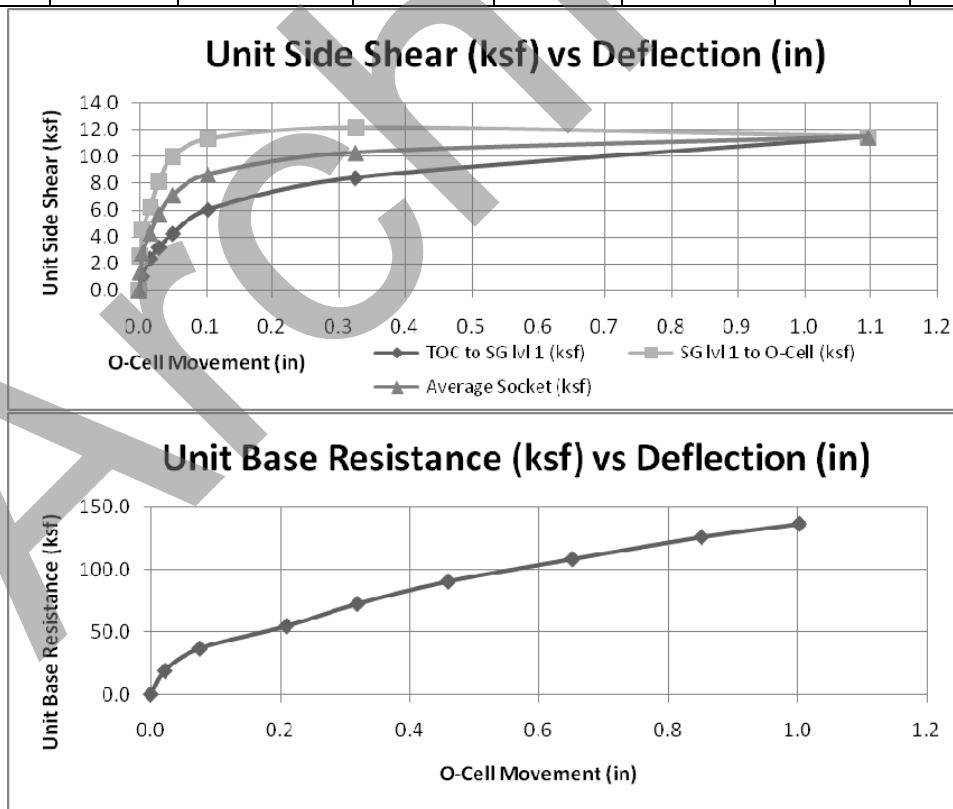


**Shaft Summary**

Shaft Diameter (in)	Total Shaft Length (ft)	Shaft Length Below O-cell (ft)	Shaft Length Above O-cell (ft)	O-cell Size (in)	Max Net Load (kips)	SS Creep Load (kips)	EB Creep Load (kips)
42.0	41.7	0.7	12.0	26.0	1402.0	1050.0	940.0

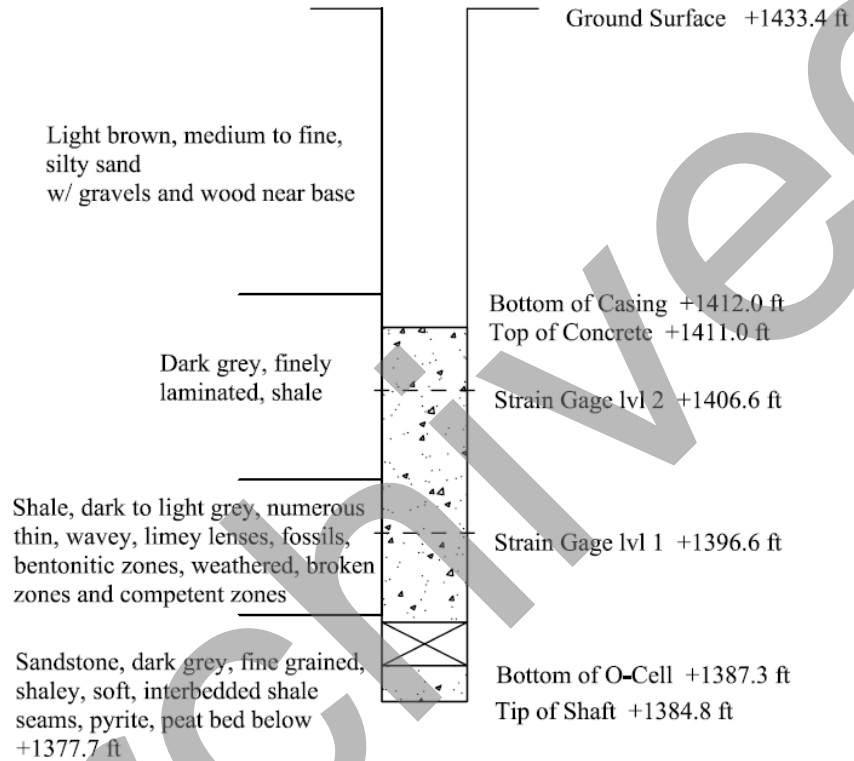
**Data Summary**

Elevation (ft.)	Average $q_u$ (ksf)	Rock Core Recovery (%)	Rock Core RQD	Unit EB (ksf)	EB Deflection (in)	Unit SS (ksf)	SS Deflection (in)
1518.3							
1516.4	1.1						
1514.4							
1511.6	0.8						
1506.4	0.5						
1501.4	0.7						
1493.9							
1492.5							
1490.7	22.2	91	84				
1488.4							
1487.4	146.0	91	84			11.4	
1484.8	20.3	100	99				1.1
1483.7							
1481.9	23.6	97	100			11.6	
1479.3	36.0	97	100				
1477.3							
1476.6				136.7	1.0		
1466.8	113.2	58.0	100				
1462.9	95.3	58	100				
1462.3	49.6	58	100				





The dedicated test shaft was constructed on March 28, 2001. The 72-in test shaft was socketed into rock and constructed dry to a total depth of 48.7 ft. The shaft was started at a ground surface elevation of +1433.4 ft with a temporary 72-in I.D. surface casing. The shaft was excavated using an earth auger. A clean-out bucket was used for cleaning the base of the shaft. After the carrying frame and O-cell assembly were inserted into the shaft, concrete was placed by pump through a 5-in O.D. pipe into the base of the shaft until the top of the concrete reached an elevation of +1410.9 ft. No unusual problems occurred during construction of the shaft. The O-cell was located 2.5 ft above the tip of shaft.

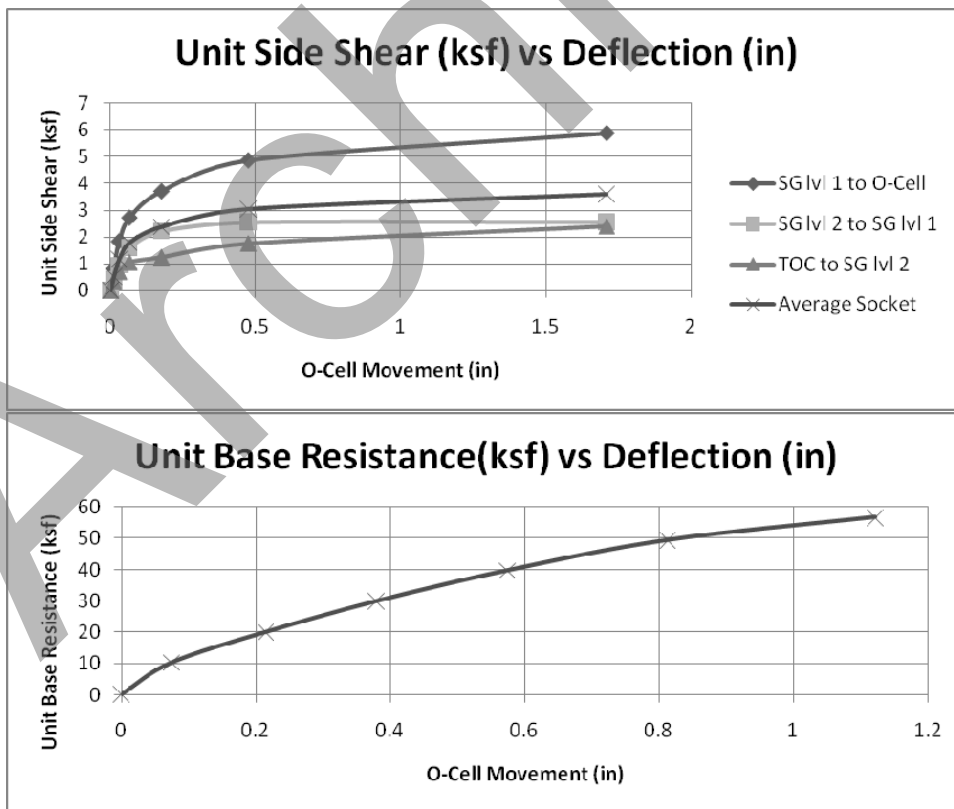


**Shaft Summary**

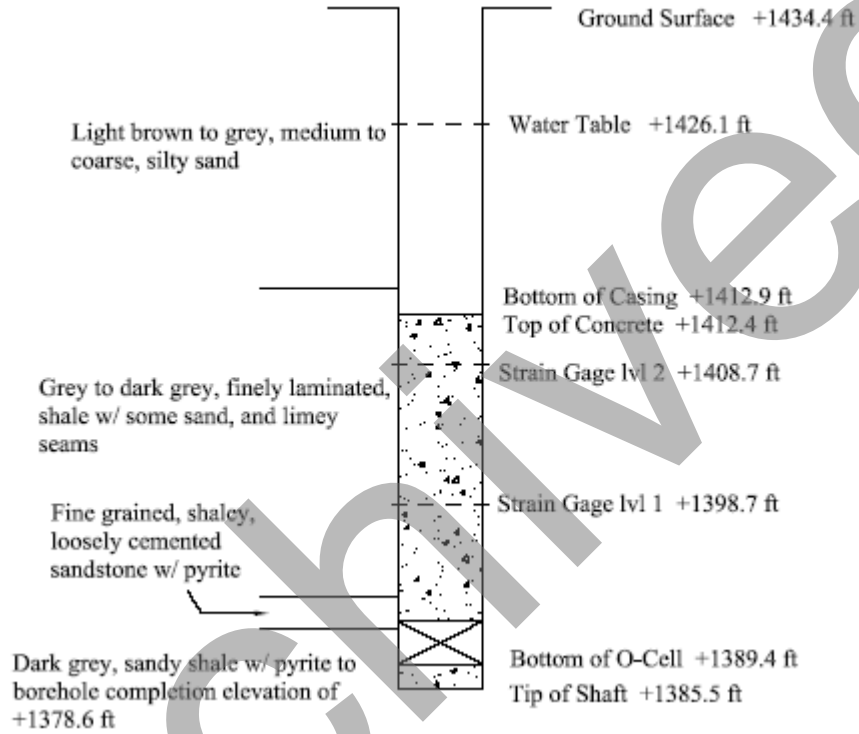
Shaft Diameter (in)	Shaft Length (ft)	Shaft Length Below O-cell (ft)	Shaft Length Above O-cell (ft)	O-cell Size (in)	Max Net Load (kips)	SS Creep Load (kips)	EB Creep Load (kips)
72.0	48.7	2.5	23.8	34.0	1775.92	1169.00	315.00

**Data Summary**

Elevation (ft.)	Average $q_u$ (ksf)	Rock Core Recovery (%)	Rock Core RQD	Unit EB (ksf)	EB Deflection (in)	Unit SS (ksf)	SS Deflection (in)
1433.4							
1413.3							
1411.0							
1410.9	13.20	86	22			2.26	
1407.9	32.52	101	58				
1406.6							
1404.5	25.50	94	38			2.44	
1401.3	31.99	94	38				
1396.6							1.72
1395.9	8.82	56	48				
1393.6	19.63	139	100			6.07	
1392.3	22.88	139	100				
1390.8							
1387.3							
1386.1	2.77	121	61				
1384.8				56.90	1.12		
1383.9	6.86	121	61				
1379.0	3.08	72	61				



The dedicated test shaft was constructed on March 30, 2001. The 72-in test shaft was socketed in rock and constructed dry to a total depth of 49.0 ft. The shaft was started at a ground surface elevation of +1434.4 ft with a temporary 72-in I.D. surface casing. The shaft was excavated using an earth auger. A clean-out bucket was used for cleaning the base of the shaft. After the carrying frame and O-cell assembly were inserted into the shaft, concrete was placed by pump through a 5-in O.D. pipe into the base of the shaft until the top of the concrete reached an elevation of +1412.4 ft. The O-cell was located 3.9 ft above the tip of the test shaft. No unusual problems occurred during construction.

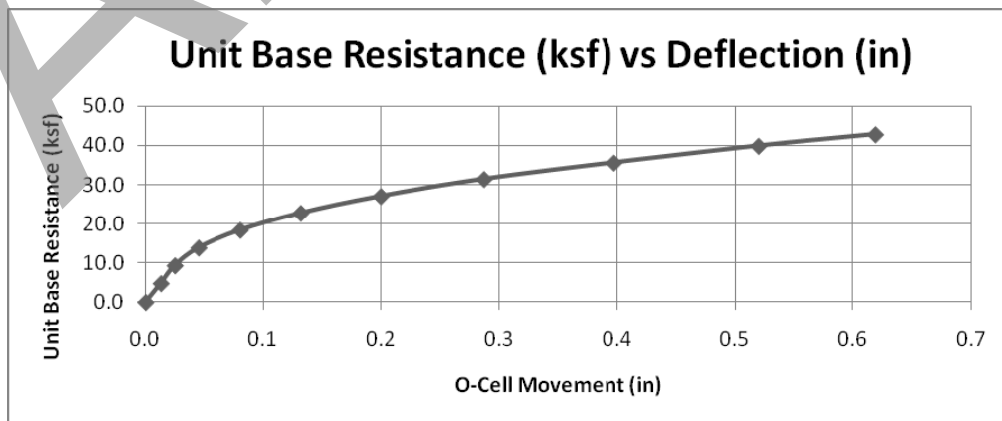
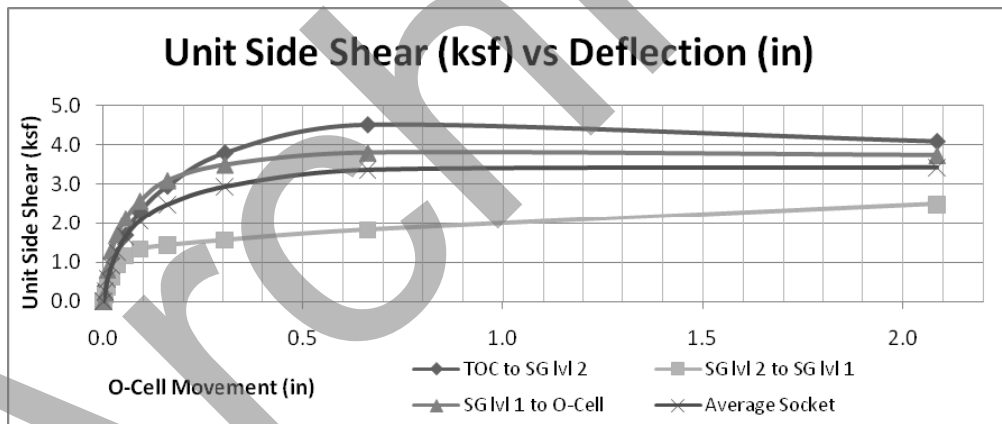


**Shaft Summary**

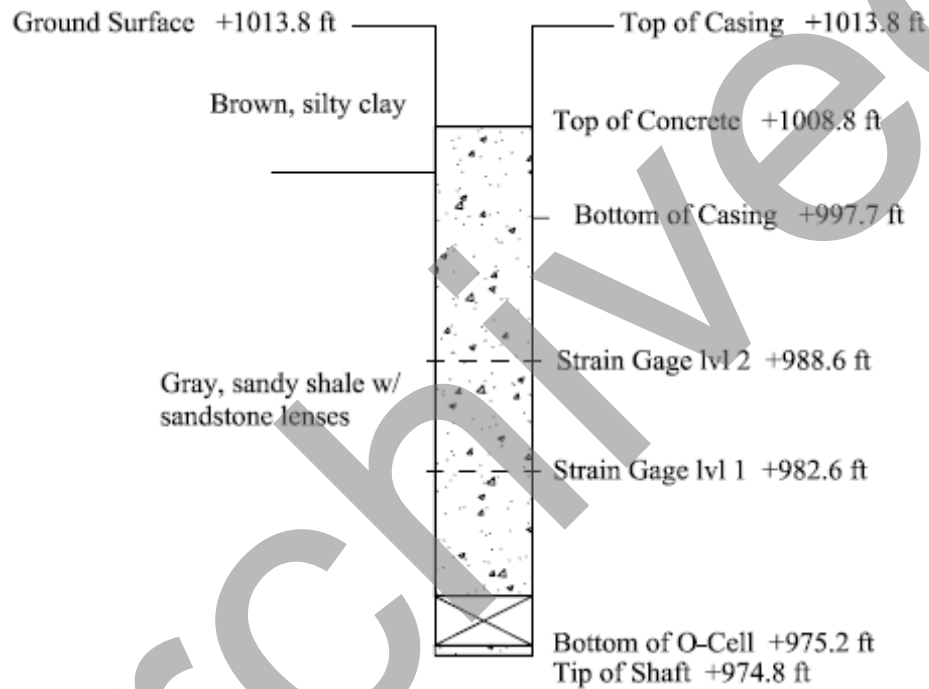
Shaft Diameter (in)	Shaft Length (ft)	Shaft Length Below O-cell (ft)	Shaft Length Above O-cell (ft)	O-cell Size (in)	Max Net Load (kips)	SS Creep Load (kips)	EB Creep Load (kips)
72.0	49.0	3.9	23.0	34.0	1470.00	1057.00	360.00

**Data Summary**

Elevation (ft.)	Average $q_u$ (ksf)	Rock Core Recovery (%)	Rock Core RQD	Unit EB (ksf)	EB Deflection (in)	Unit SS (ksf)	SS Deflection (in)
1434.4							
1414.3							
1412.4						3.95	
1408.7							
1408.4	24.5	94	15				
1404.0	918.2	97	25			2.38	
1403.0	21.8	72	56				
1401.5	8.3	72	56				
1398.7							
1398.5	4.6	72	56				
1396.6	15.2	100	94				
1394.3	18.2	100	94			3.93	
1392.0							
1390.9	4.2	99	52				
1389.7							
1389.4							
1388.3	7.6	74	0				
1385.5				44.1	0.62		



The test shaft was constructed on January 23, 2001. The shaft was constructed dry with a total length of 38.6 ft. The shaft was drilled to top of rock with an auger. A surface casing was then placed after over-reaming the shaft excavation by 3-in. The shaft excavation was then continued until the tip elevation was reached. The bottom was hand cleaned. Three feet of concrete was placed at the bottom of the shaft and then the O-Cell assembly was placed into the wet concrete attached to the rebar cage until it settled down to its final elevation. Concrete was then placed to an elevation of +1008.8 ft. No unusual problems occurred during shaft construction.

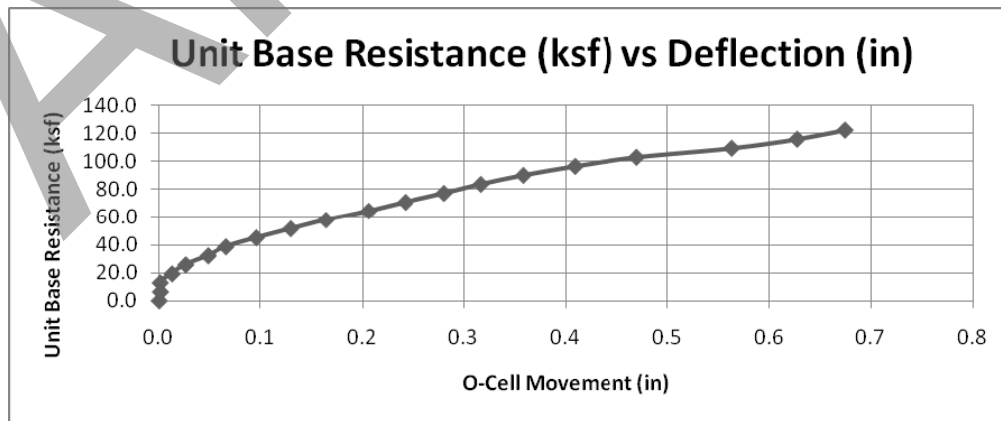
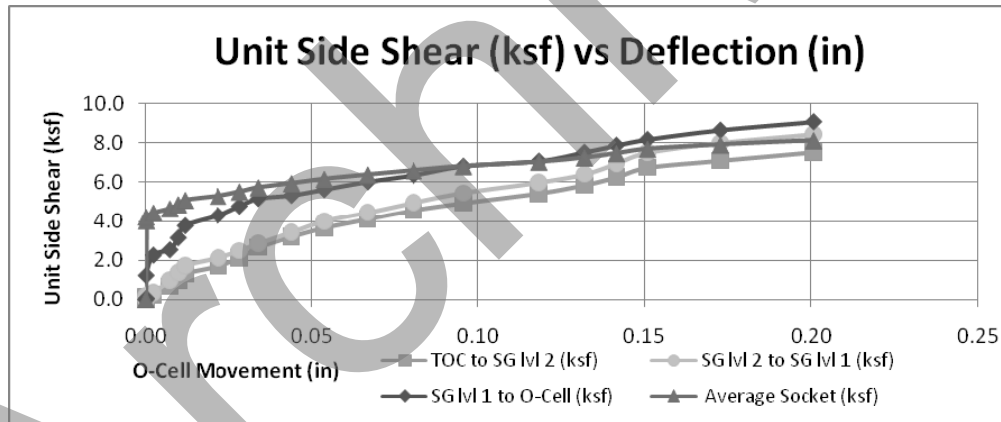


**Shaft Summary**

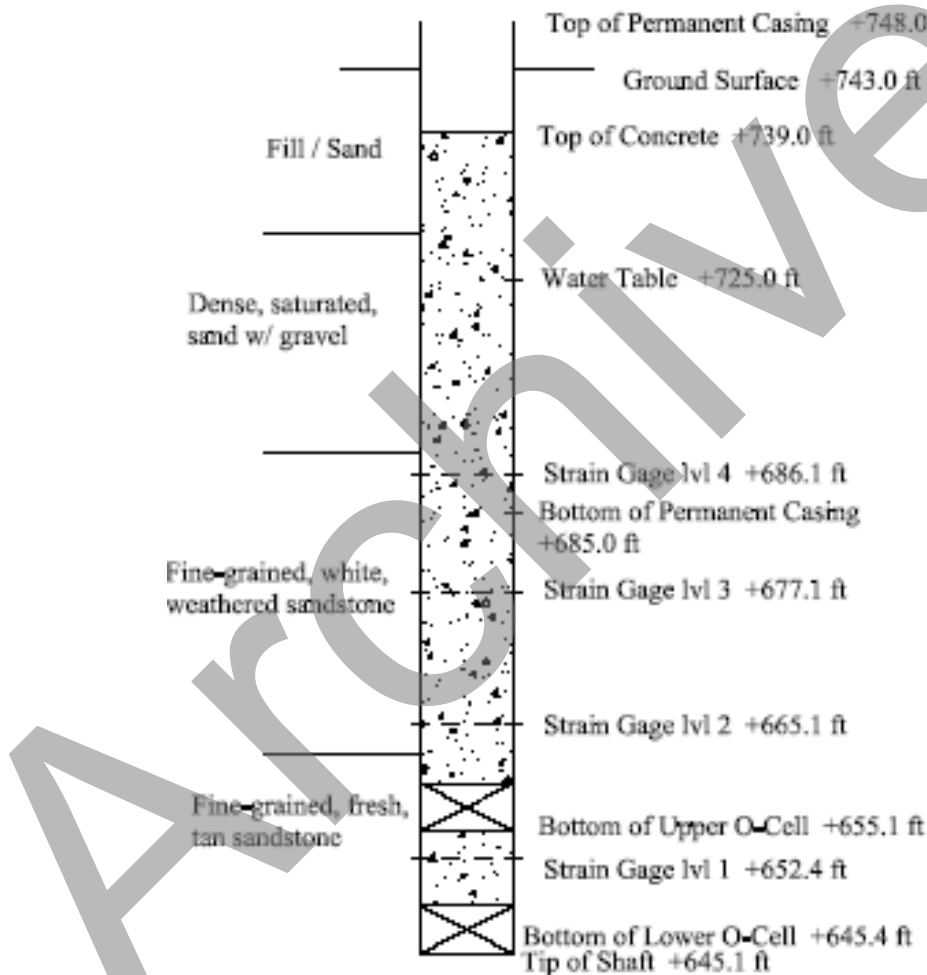
Shaft Diameter (in)	Shaft Length (ft)	Shaft Length Below O-cell (ft)	O-cell Size (in)	Max Net Load (kips)	SS Creep Load (kips)	EB Creep Load (kips)
72.0	39.0	0.4	26.0	3660.0	not reached	2700.0

**Data Summary**

Elevation (ft.)	Average $q_u$ (ksf)	Unit EB (ksf)	EB Deflection (in)	Unit SS (ksf)	SS Deflection (in)
1013.9					0.201
1008.9					
999.6	2.4				
997.7					
995.2	15.1			7.38	
990.0	9.1				
988.6					
982.6				8.19	
980.5	22.1			9.95	
975.2		127.0	0.675		
974.9					
973.9	23.9				
966.2	25.2				
958.6	59.4				
955.6	102.4				
952.5	699.1				
949.3	54.3				
947.1	63.0				



The test shaft was excavated between November 9 and 11, 2007. The final cleanout and concreting took place on November 15, 2007. The 78-in test shaft was excavated to a tip elevation of +645.1 ft under polymer slurry. The shaft was started by pre-drilling and inserting a permanent 84-in O.D. casing into the top of bedrock to an approximate tip elevation of +685.0 ft. An auger was used for drilling and a bucket was used for bottom cleanout. After cleaning the base, the reinforcing cage with attached O-cell assemblies was inserted into the excavation and temporarily supported from the steel casing. Concrete was then delivered by pump through a pipe into the base of the shaft until the top of the concrete reached an elevation of +739.0 ft. No unusual problems occurred during construction of the shaft. Note: Strain Gage levels 1 and 4 yielded higher loads than applied by either the O-cells or by strain gage levels in closer proximity to the upper O-cells and therefore are not included in analysis.



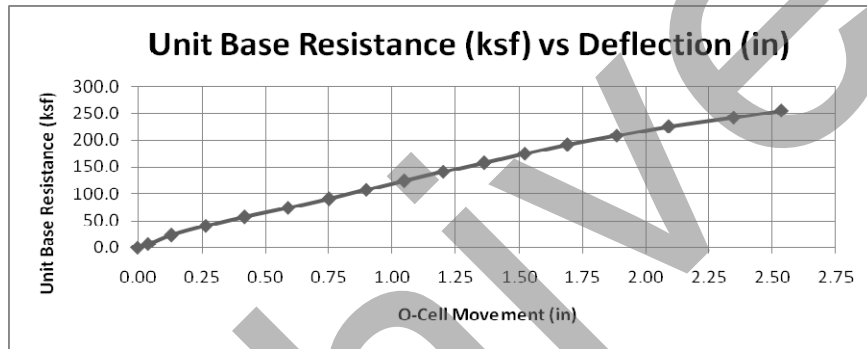
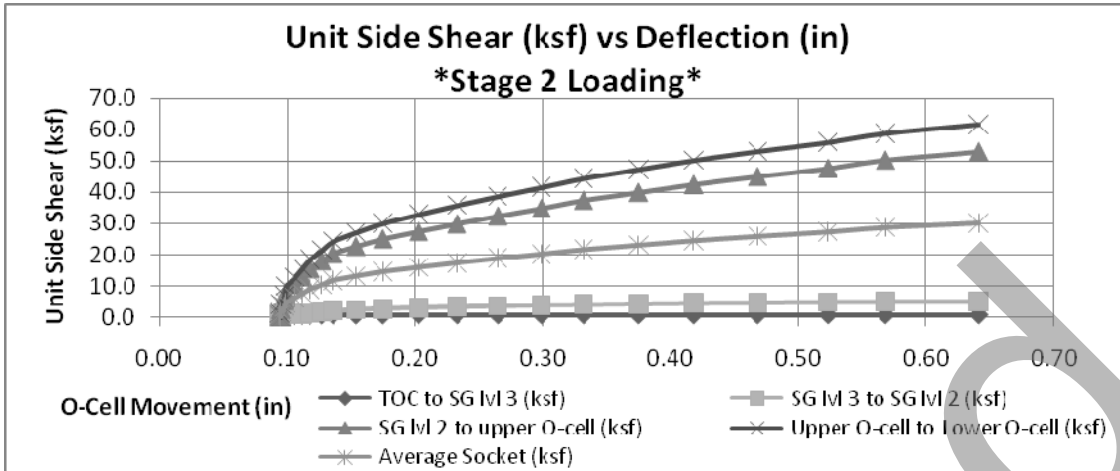
**Shaft Summary**

Shaft Diameter (in)	Shaft Length (ft)	Length Below Upper O-cell (ft)	Length Below Lower O-cell (ft)	O-cell Size (in)	Max Net Load (kips)	SS Creep Load (kips)	EB Creep Load (kips)
78.0	97.9	10.0	0.3	26.0	12219.0	not reached	not reached

**Data Summary**

Elevation (ft.)	SPT "N <sub>60</sub> " (Blows / ft)	Average q <sub>u</sub> (ksf)	Rock Core Recovery (%)	Rock Core RQD	Unit EB (ksf)	EB Deflection (in)	Unit SS (ksf)	SS Deflection (in)
743.0								0.64
739.0								
738.0	7.0							
732.0	20.0							
725.0	44.0							
720.0	44.0							
715.0	67.0						0.2	
705.0	78.0							
702.0	37.0							
695.0	13.0							
690.0	59/9"							
686.1								
677.1								
668.0		5.90	72	50			4.5	
665.1								
658.0		109.87	47	74			54.2	
655.1								
652.4								
649.0		199.01	85	36				
645.4								
645.1					257.0	2.35		
641.0		78.62	8	5				
635.0		56.02	93	76				
631.0		92.74	93	70				





A dedicated test shaft was constructed through 65 feet of overlying silts and sands with a 32-foot socket into clay/chalk. The shaft was constructed using a temporary casing and slurry. Concrete was placed below the O-cell level creating a 21-foot test socket above the O-cell. There were no unusual problems during the construction of the test shaft.

**Shaft Summary**

Shaft Diameter (in)	Shaft Length (ft)	Max Net Load (kips)	Max Deflection Up (in)
66.0	96.0	2200.0	0.18

**Data Summary**

Material	Location	Average $S_u$ (ksf)	Average $q_u$ (ksf)	Unit EB (ksf)	EB Deflection (in)	Unit SS (ksf)	SS Deflection (in)
Chalk	Strain Gage lvl 4	6.05	12.1			2.4	0.18
Chalk	Strain Gage lvl 3	6.05	12.1			1.4	0.18
Chalk	Strain Gage lvl 2	6.05	12.1			6	0.18
Chalk	Strain Gage lvl 1	6.05	12.1			7.6	0.18
Chalk	Base	6.05	12.1	11.0	0.66		
Chalk	Base	6.05	12.1	16.8	1.32		
Chalk	Base	6.05	12.1	45.0	3.3		
Chalk	Base	6.05	12.1	46.2	3.39		

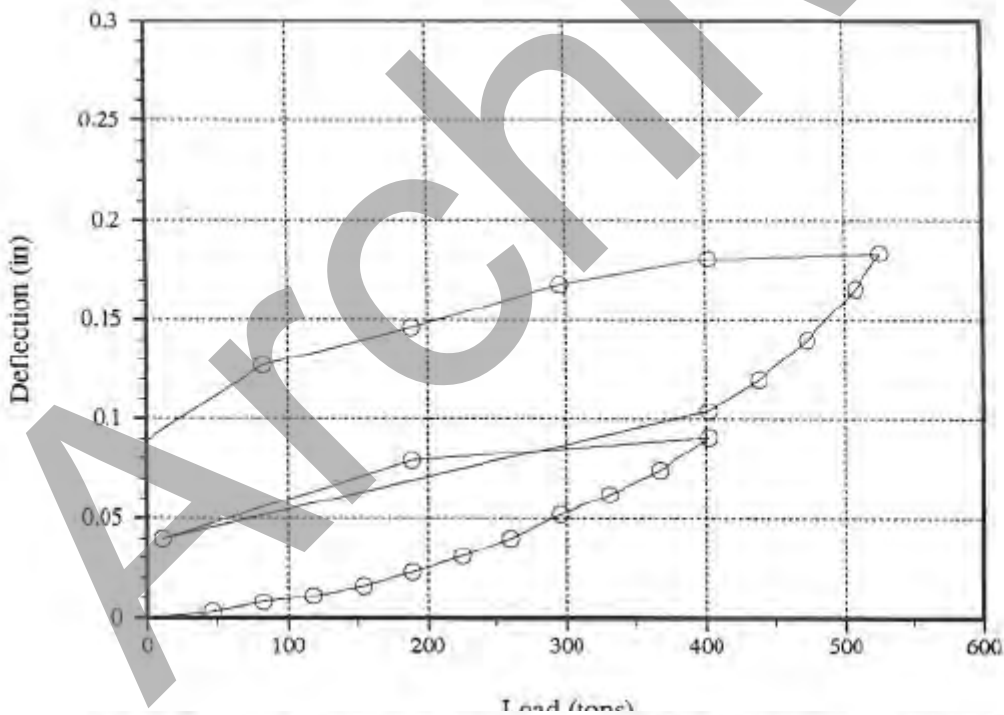
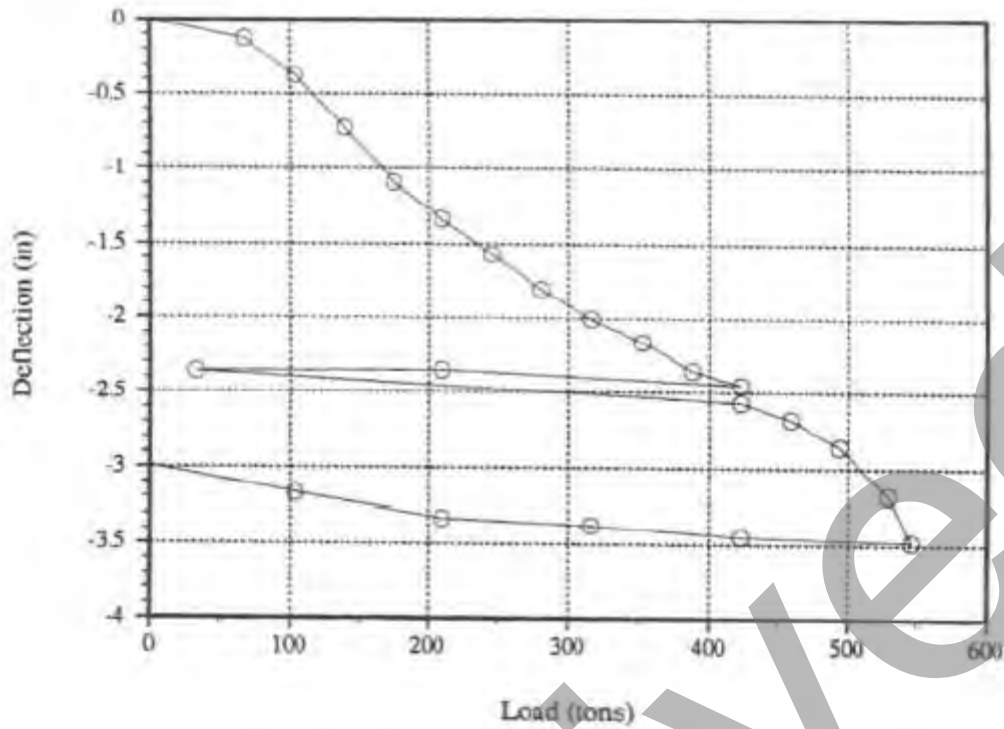


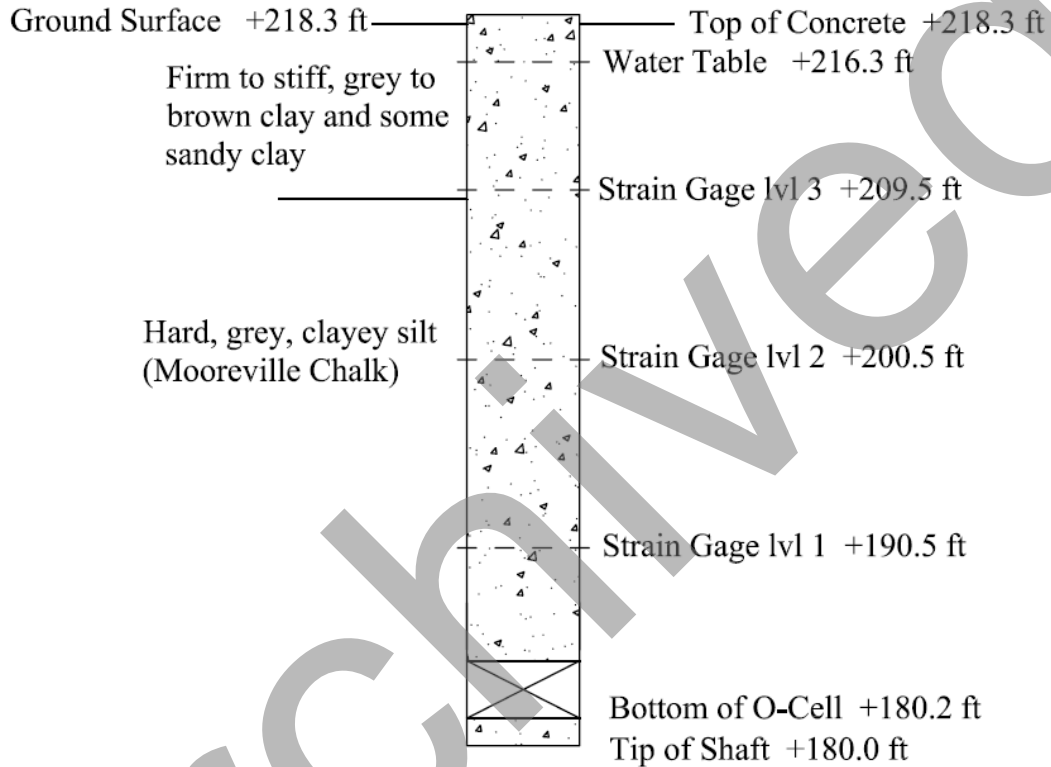
Figure A-24 - Load-deflection curve (shaft upward), Leake Co., MS

**US 45 over Town Creek**

**Lee County, Mississippi**

**Test Shaft 1**

The dedicated test shaft was constructed on November 9, 1994. The 48-in test shaft was constructed dry to a total length of 34.2 ft. An auger was used for drilling and cleaning the shaft. A 48-inch diameter temporary casing was inserted into the excavation to keep the excavation open for concrete placement. A seating layer of 3 inches of concrete was placed in the shaft, and then the reinforcing cage with attached O-cell assembly was inserted into the excavation and into the seating layer of concrete with the base of the O-cell at elevation +180.2 ft. Concrete continued to be delivered by freefall until the top of the concrete reached an elevation of +218.3 ft (ground surface). The temporary casing was pulled as concrete was placed. No unusual problems occurred during the construction of the test shaft.



**Shaft Summary**

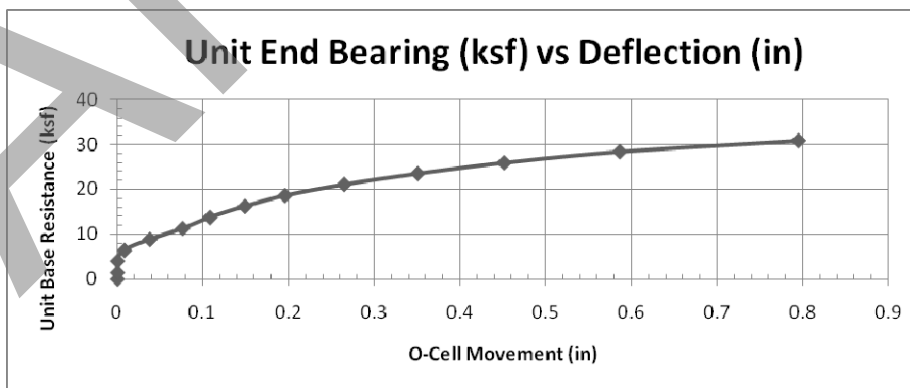
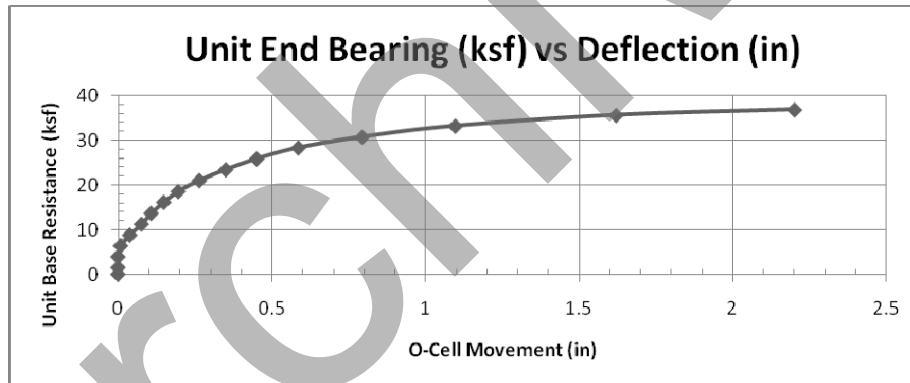
Shaft Diameter (in)	Shaft Length (ft)	Shaft Length Below O-cell (ft)	Shaft Length Above O-cell (ft)	O-cell Size (in)	Max Net Load (kips)	Max Deflection Up (in)	SS Creep Load (kips)	EB Creep Load (kips)
48.0	38.3	0.2	38.1	34.0	1896.00	0.11	2280.00	1470.00

### Data Summary

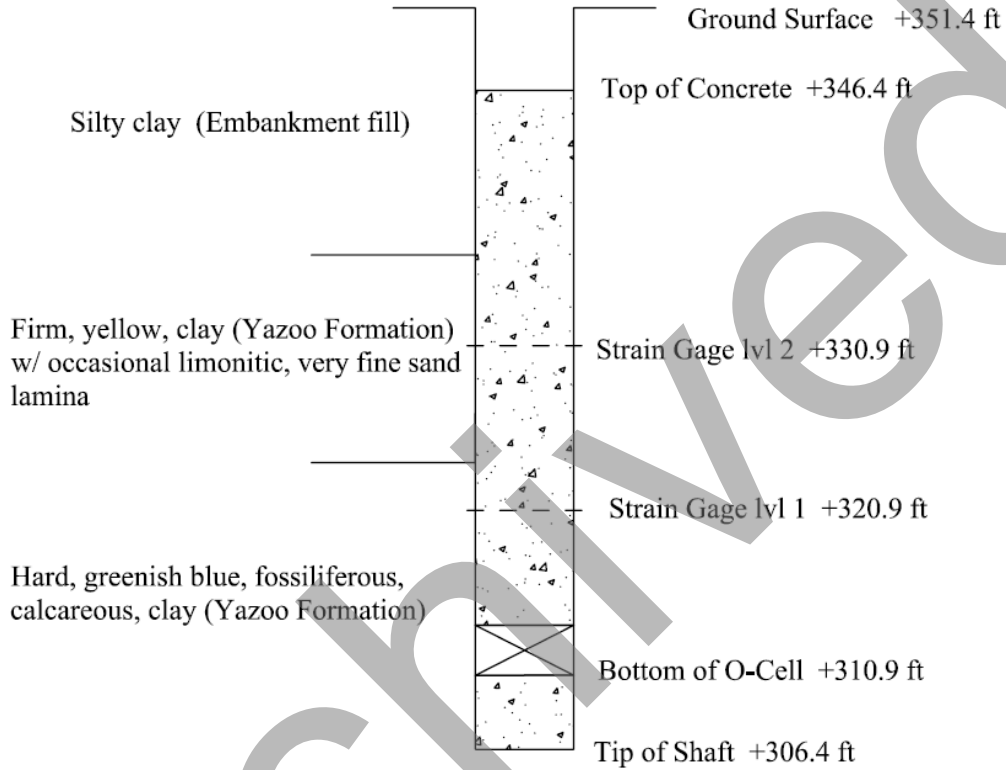
Elevation (ft.)	Average $S_u$ (ksf)	Avg. $\phi$ ( $^\circ$ )	Average $q_u$ (ksf)	Unit EB (ksf)	EB Deflection (in)	Unit SS (ksf)	SS Deflection (in)
218.3							
209.0	6	29				5.12	0.11
202.7			17.06				
200.5			34.26				
187.4			17.24				
180.0				197.0	2		
174.1			24.48				
165.5			24.6				

### Unit Side Shear Curves

There are no unit side shear curves for this test. During the test, the strain gages did not record any change in strain at any of the gage locations. The recording equipment was believed to be functioning properly, so this indicates that there was no strain at the gages. This would mean that the side shear was concentrated in the 10-foot section between the top of the O-cell and Strain Gage Level 1. At the maximum load of 928 tons, this would result in a unit side shear of 14.7 ksf. If the side shear was assumed to be distributed over the entire length of the chalk socket, the resulting unit side shear would be 5.12 ksf.



The dedicated test shaft was constructed on April 12, 2001. The 24-in test shaft was constructed dry to a total depth of 45 ft. An auger was used for drilling and cleaning the shaft. A seating layer of concrete was placed in the base of the shaft by gravity pour, the reinforcing cage was inserted in the shaft and the remainder of the concrete was placed by gravity pour until reaching elevation +346.4 ft. No unusual problems occurred during construction of the shaft.

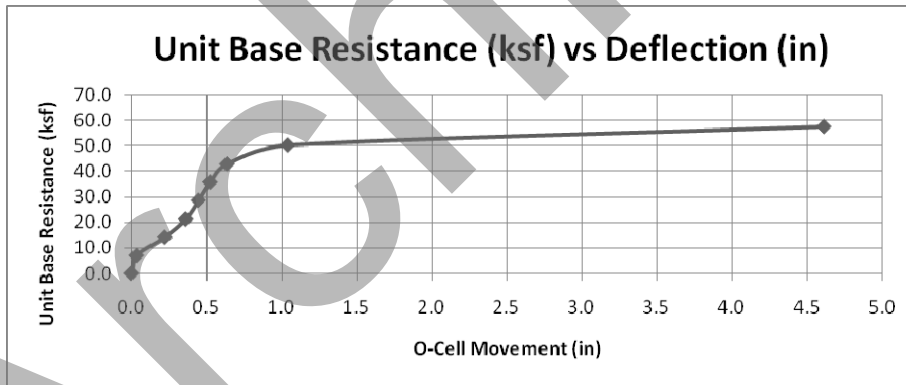
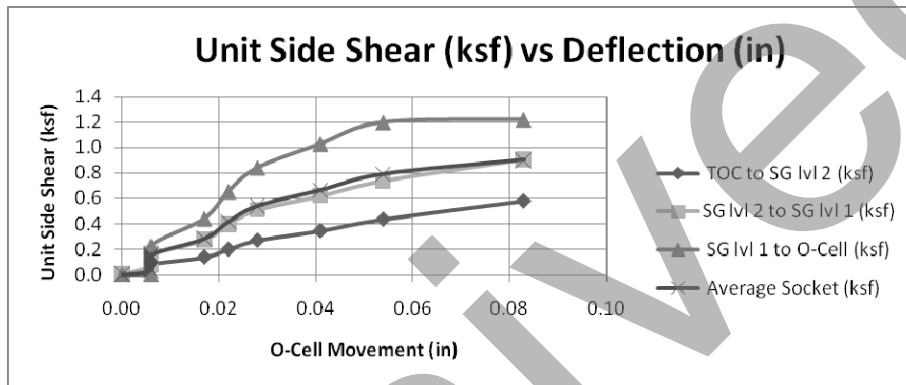


**Shaft Summary**

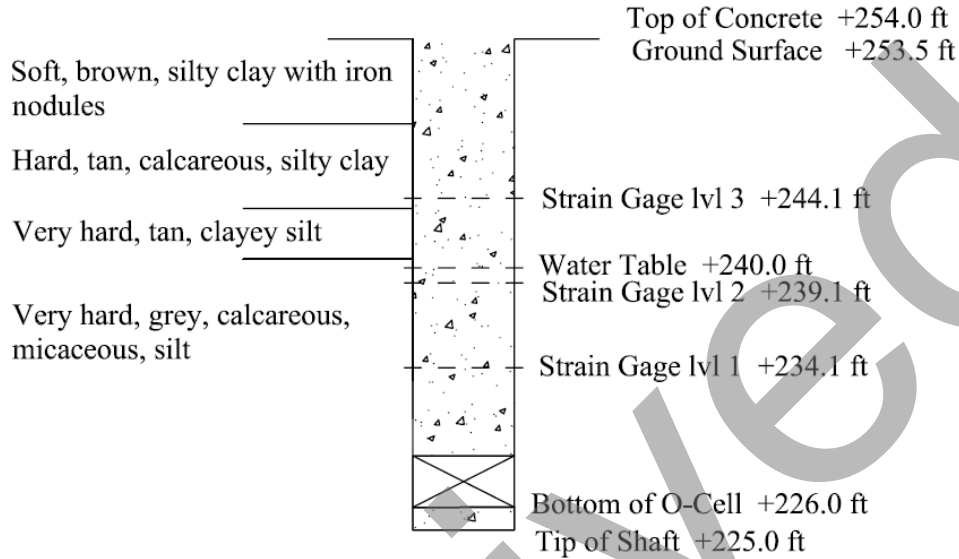
Shaft Diameter (in)	Shaft Length (ft)	Shaft Length Below O-cell (ft)	Shaft Length Above O-cell (ft)	O-cell Size (in)	Max Net Load (kips)	Max Deflection Up (in)	SS Creep Load (kips)	EB Creep Load (kips)
24.0	45.0	4.5	35.5	13.0	207.0	0.08	0.00	154.0

### Data Summary

Elevation (ft.)	Average $S_u$ (ksf)	Avg. $\phi$ (°)	Average $q_u$ (ksf)	Unit EB (ksf)	EB Deflection (in)	Unit SS (ksf)	SS Deflection (in)
351.4	2.5	0					
346.4						0.32	
330.9							
328.4	4.5	13				0.83	
322.4			11.1				0.083
320.9							
310.9						1.48	
306.4				52.6	4.613		



The test shaft was constructed on July 21, 1998. The 42-in test shaft was constructed dry with a total length of 29.0 feet. No unusual problems occurred during construction of the test shaft.



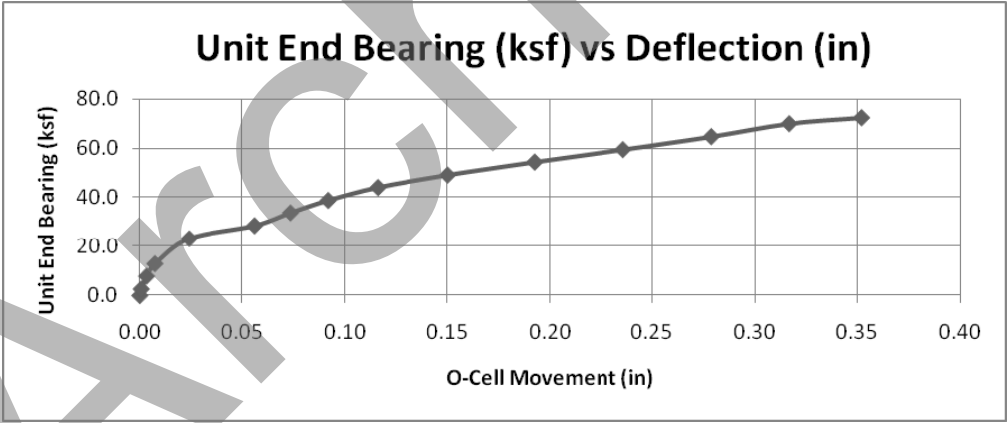
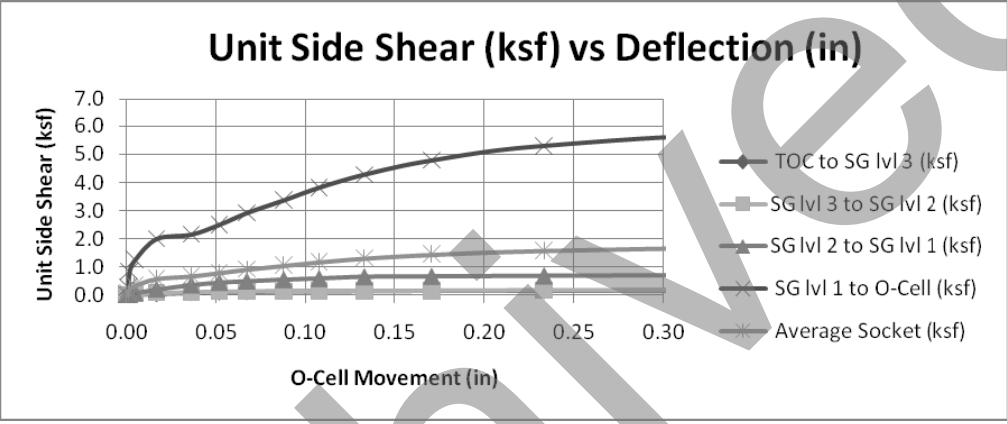
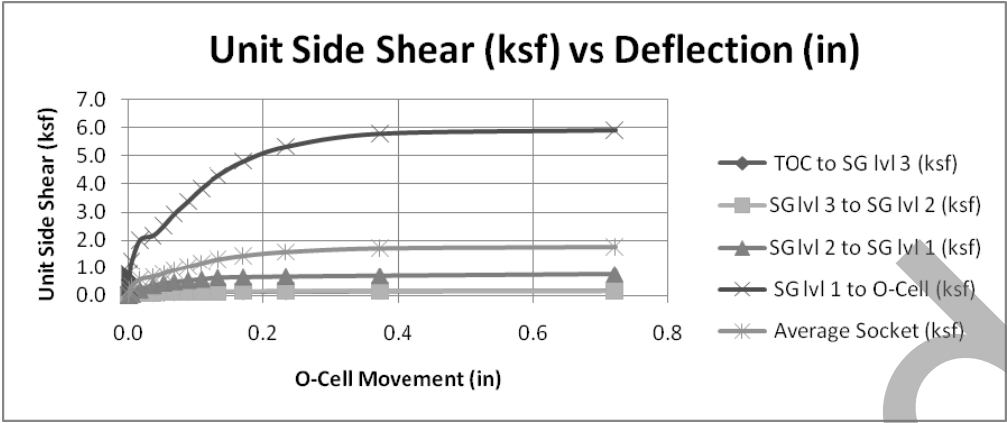
**Shaft Summary**

Shaft Diameter (in)	Shaft Length (ft)	Shaft Length Below O-cell (ft)	Shaft Length Above O-cell (ft)	O-cell Size (in)	Max Net Load (kips)	Max Deflection Up (in)	SS Creep Load (kips)	EB Creep Load (kips)
42.0	29.0	1.0	28.0	21.0	716.00	0.72	562.00	0.00

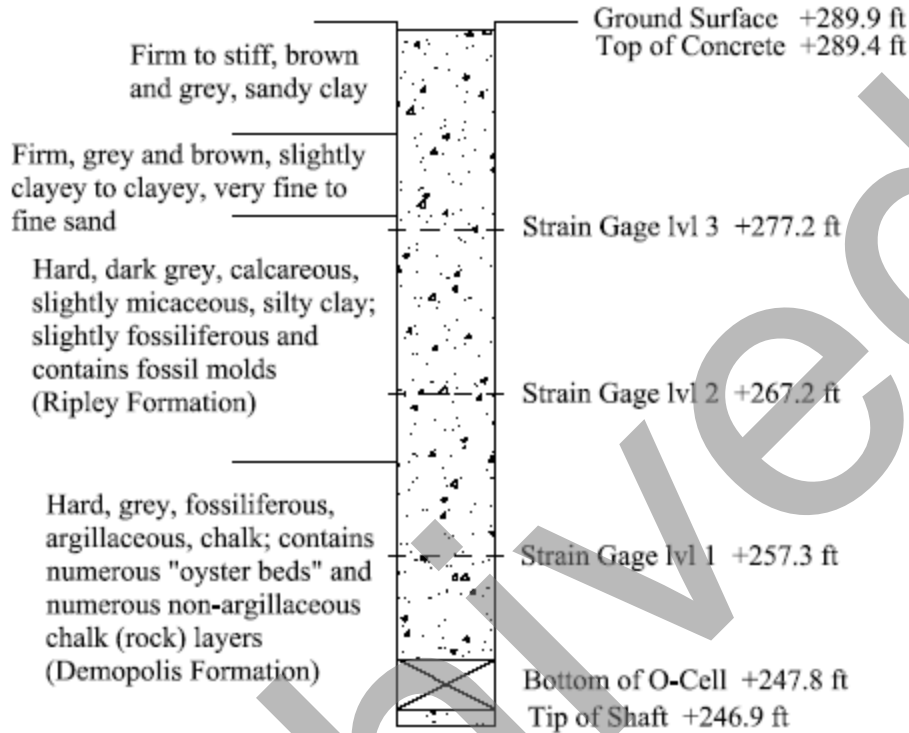
**Data Summary**

Elevation (ft.)	Average $q_u$ (ksf)	Average $\phi$ (°)	Unit EB (ksf)	EB Deflection (in)	Unit SS (ksf)	SS Deflection (in)
254.0	2.00	26			0.34	0.72
244.1					0.6	
239.1	6.14	0			2.2	
234.1	27.92	0			5.92	
226.0						
225.0			67.8	0.35		





The test shaft was constructed on June 13, 1998. The 48-in test shaft was constructed to a total length of 43.0 ft. There were no unusual problems during the construction of the test shaft.

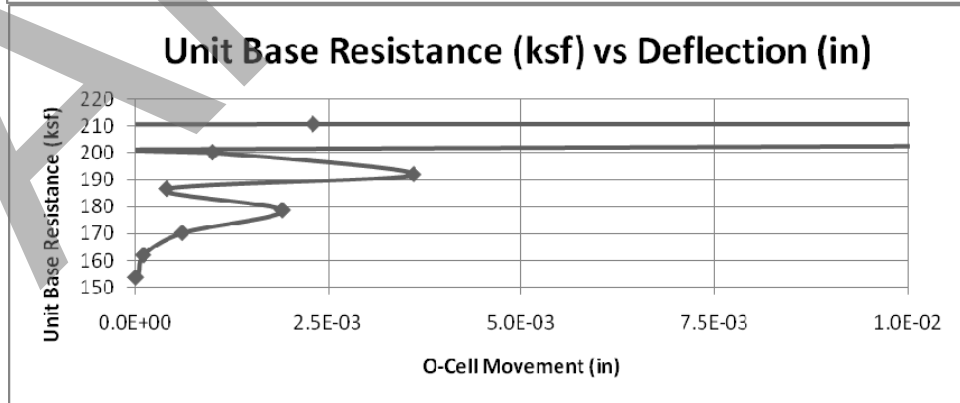
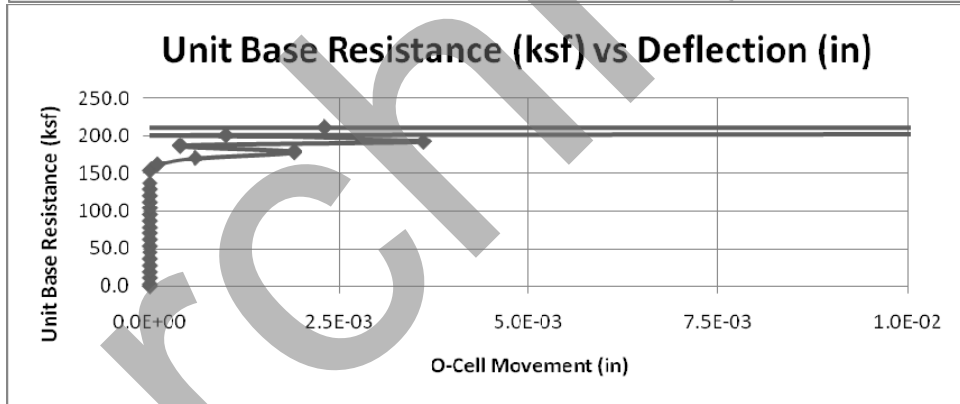
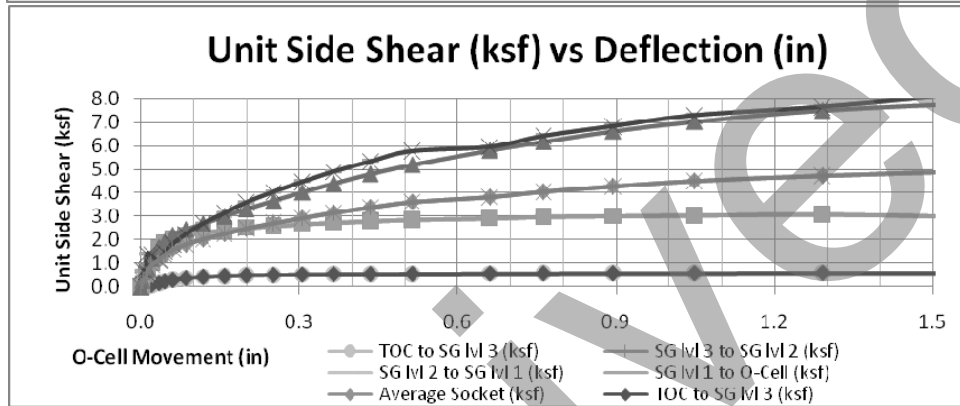
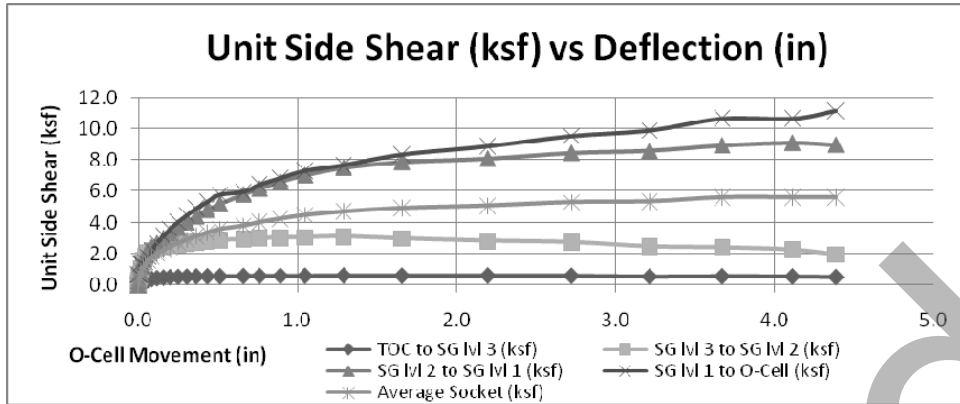


**Shaft Summary**

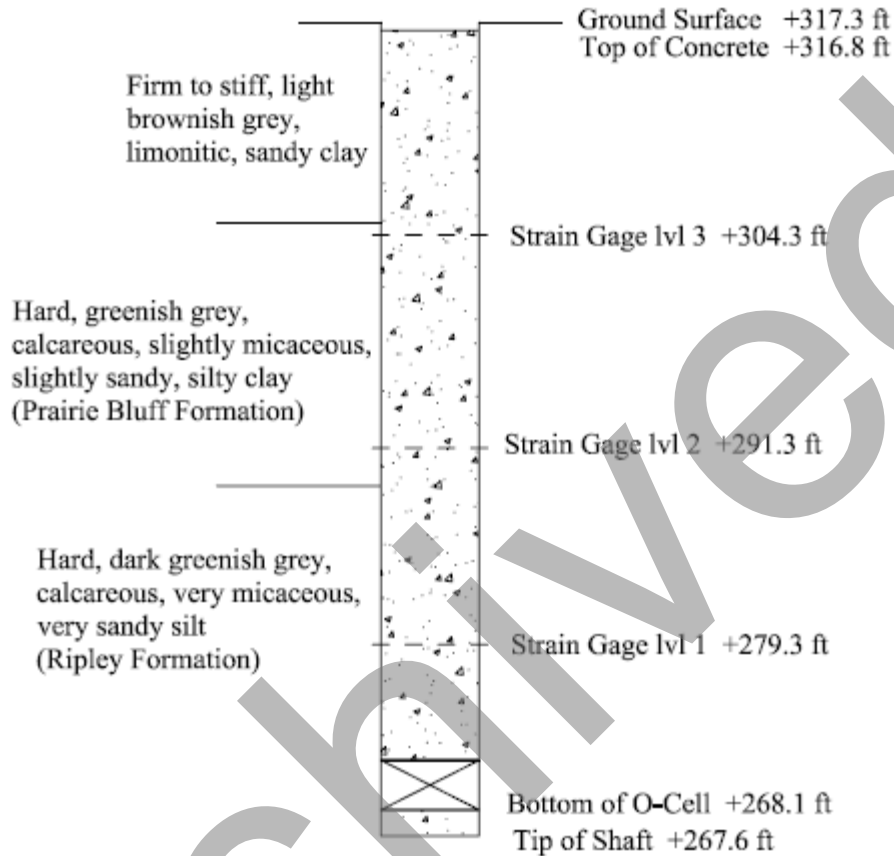
Shaft Diameter (in)	Shaft Length (ft)	Shaft Length Below O-cell (ft)	Shaft Length Above O-cell (ft)	O-cell Size (in)	Max Net Load (kips)	Max Deflection Up (in)	SS Creep Load (kips)	EB Creep Load (kips)
48.0	43.0	0.8	42.1	26.0	2770.00	4.38	0.00	2640.00

**Data Summary**

Elevation (ft.)	Average $S_u$ (ksf)	Avg. $\phi$ (°)	Average $q_u$ (ksf)	Unit EB (ksf)	EB Deflection (in)	Unit SS (ksf)	SS Deflection (in)
289.9	2.21					0.58	3.67
281.4	1.17						
277.2	4.50	36	10.9			3.06	
267.2						7.04	
262.4	12.49		38.6				
257.3						7.32	
247.8							
247.0				214	0.11		



The test shaft was constructed on June 23, 1998. The 48-in test shaft was constructed to a total length of 39.7 ft. There were no unusual problems during the construction of the test shaft

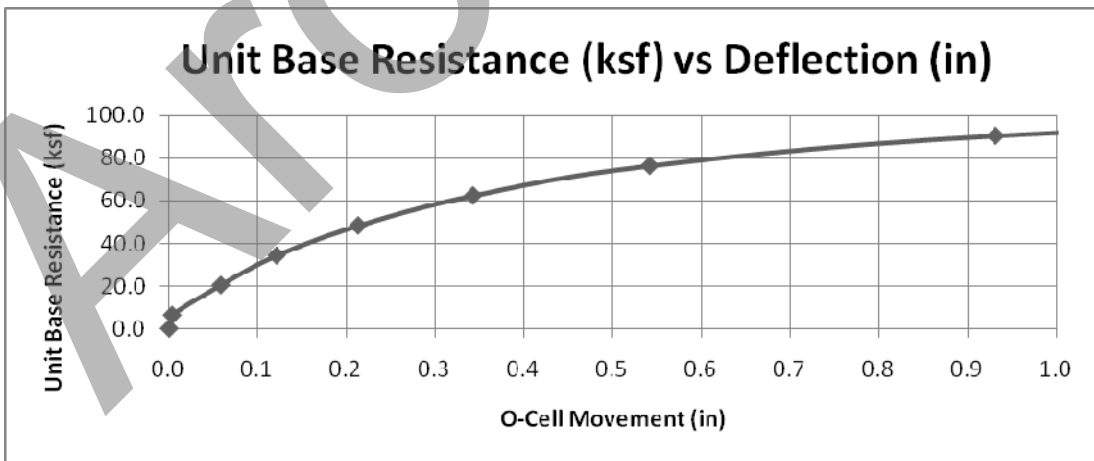
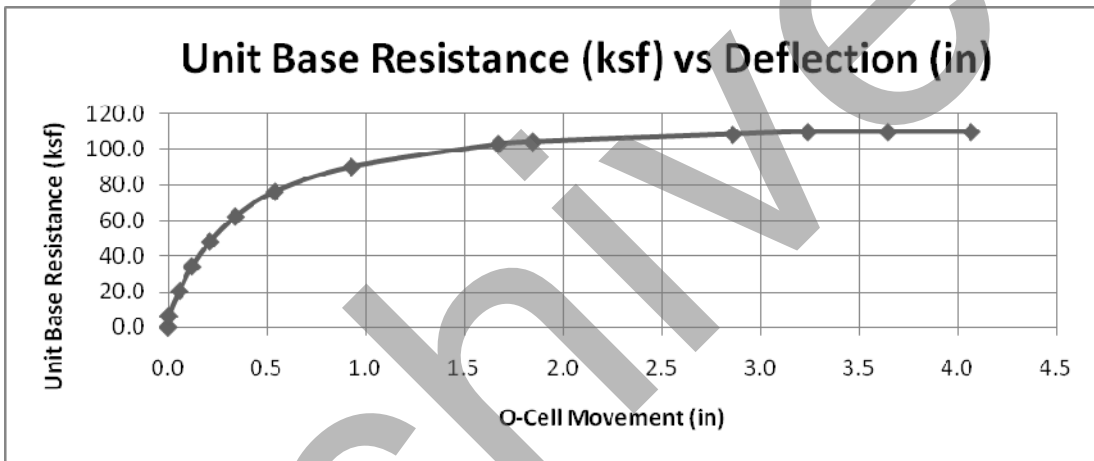
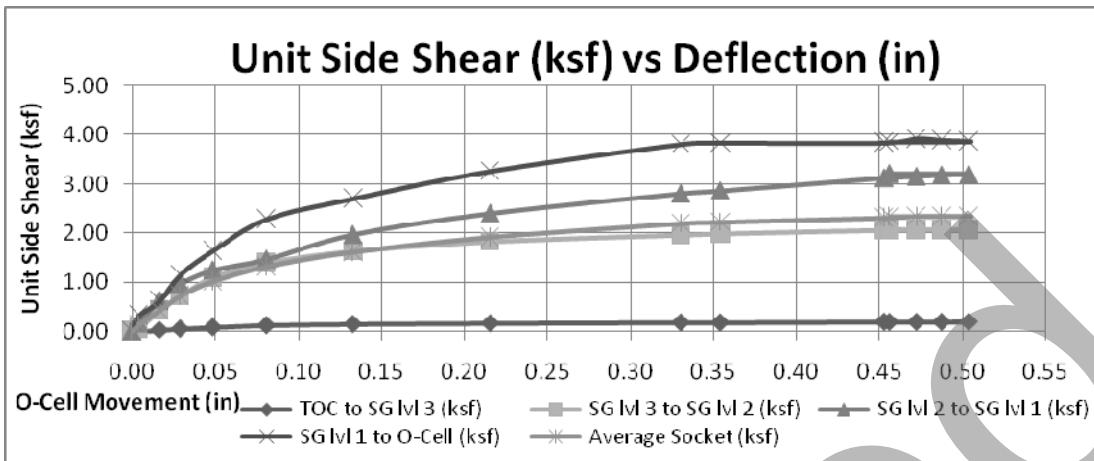


**Shaft Summary**

Shaft Diameter (in)	Shaft Length (ft)	Shaft Length Below O-cell (ft)	Shaft Length Above O-cell (ft)	O-cell Size (in)	Max Net Load (kips)	Max Deflection Up (in)	SS Creep Load (kips)	EB Creep Load (kips)
48.0	39.7	0.5	39.2	26.0	1396.0	0.51	1320.0	800.0

**Data Summary**

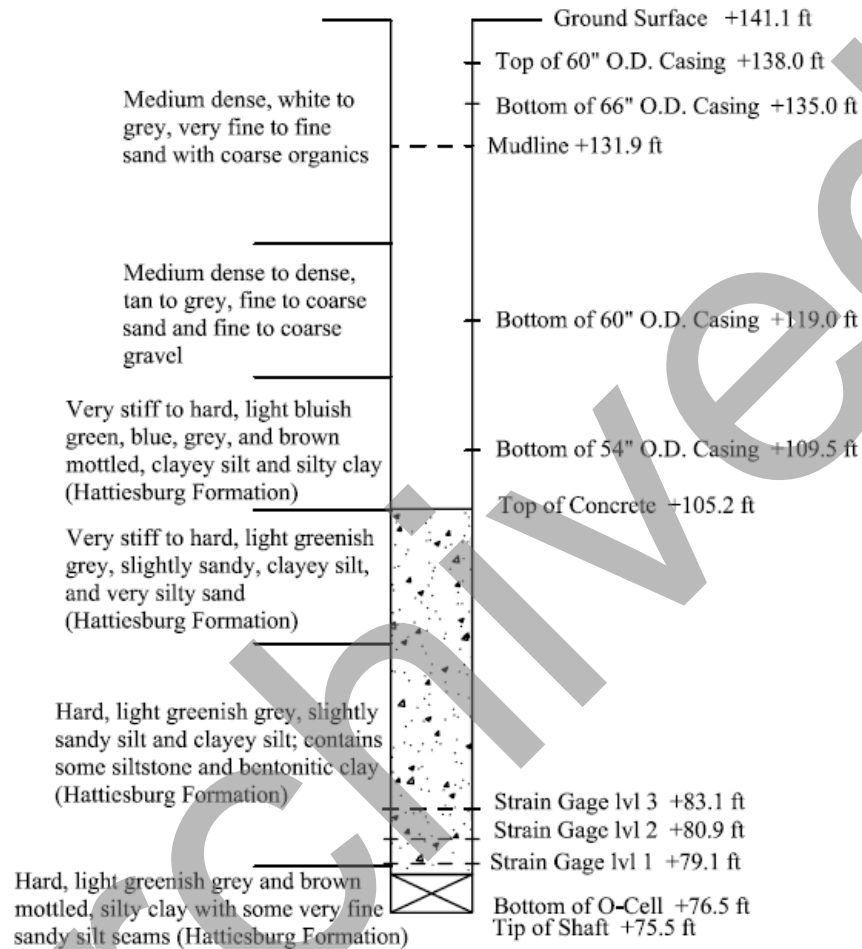
Elevation (ft.)	Average $S_u$ (ksf)	Average $\phi$ (°)	Average $q_u$ (ksf)	Unit EB (ksf)	EB Deflection (in)	Unit SS (ksf)	SS Deflection (in)
316.8	2.46					0.2	0.47
305.0	4.00	35	28.8				
304.3						2.06	
291.3						3.16	
289.0	3.00	30	27.1				
279.3						3.92	
268.1							
267.6				108	3.25		



**SR 42 over Thompson Creek Perry County, Mississippi**

**Test Shaft 1**

The test shaft was constructed on August 5, 1998. The 54-in test shaft was constructed dry with a total length of 29.8 feet. No unusual problems occurred during the construction of the test shaft

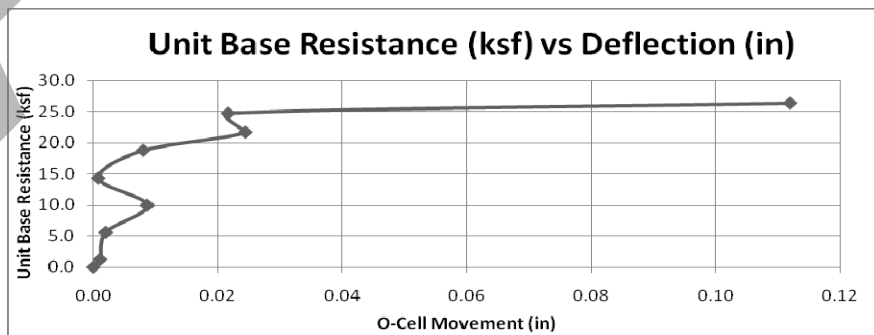
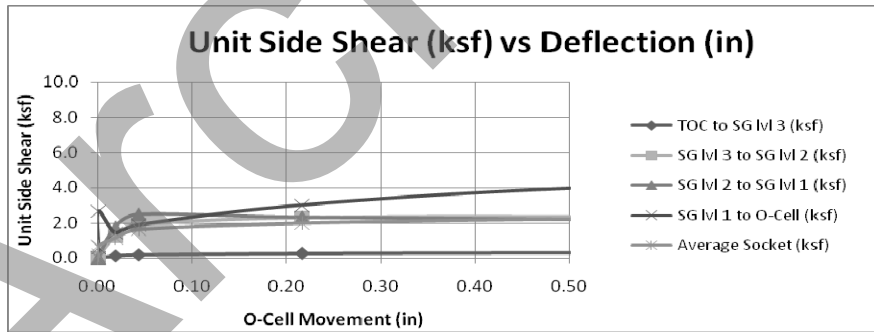
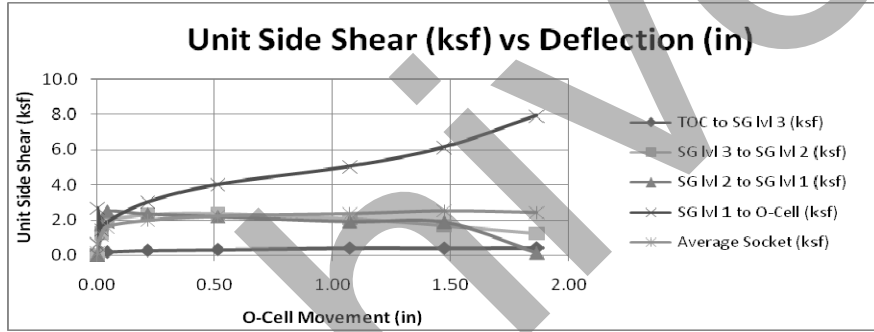


**Shaft Summary**

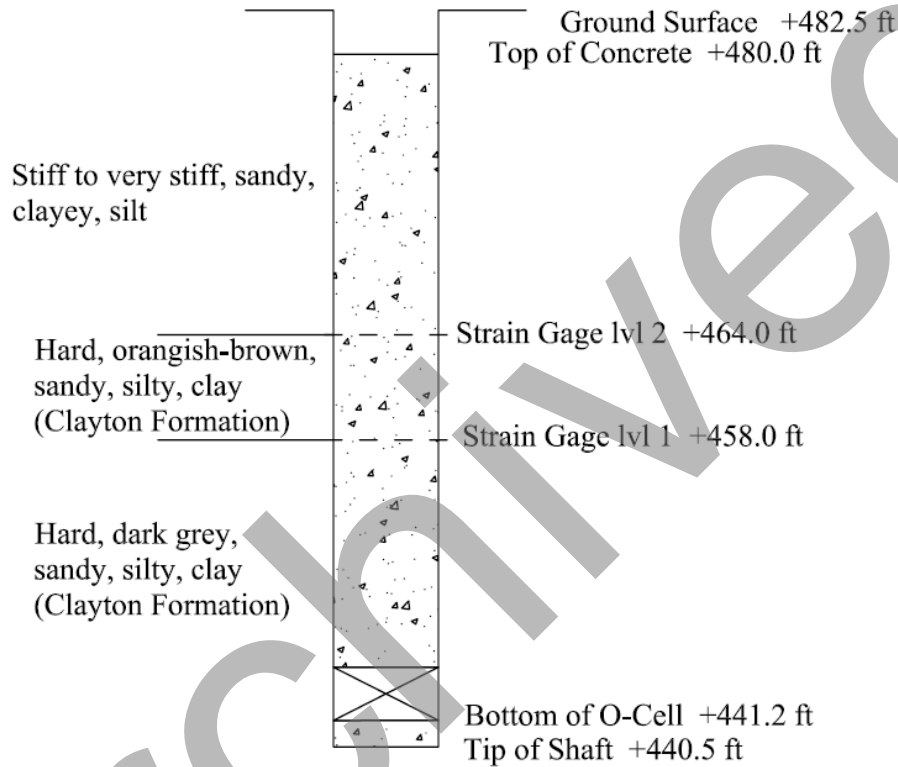
Shaft Diameter (in)	Shaft Length (ft)	Shaft Length Below O-cell (ft)	Shaft Length Above O-cell (ft)	O-cell Size (in)	Max Net Load (kips)	Max Deflection Up (in)	SS Creep Load (kips)	EB Creep Load (kips)
54.0	29.7	1.0	28.7	21.0	464.00	1.87	320.0	396.0

**Data Summary**

Elevation (ft.)	Average $S_u$ (ksf)	Avg. $\phi$ (°)	Unit EB (ksf)	EB Deflection (in)	Unit SS (ksf)	SS Deflection (in)
131.9						
124.0	0	37				
114.1	3.86	9				
107.5	3.55	12				
105.2					0.4	1.87
94.4	5.53	0				
89.5	3.55	12				
83.1	3.55	12			2.1	
80.9	3.55	12			1.92	
79.1	3.55	12			4.96	
76.5						
75.5			24.8	0.74		



The dedicated test shaft was constructed on May 16, 2003. The 48-in test shaft was constructed dry to a total length of 42.0 ft. An auger and bucket were used for drilling and cleaning the shaft. After cleaning the base, approximately four linear feet of concrete was delivered to the base of the shaft by freefall. The reinforcing cage with attached O-cell assembly was then inserted into the excavation and into the wet concrete, and temporarily supported by a boom truck with the base of the O-cell at elevation +441.2 ft. Concrete continued to be delivered by freefall until the top of the concrete reached an elevation of +480.0 ft. No unusual problems occurred during the construction of the test shaft



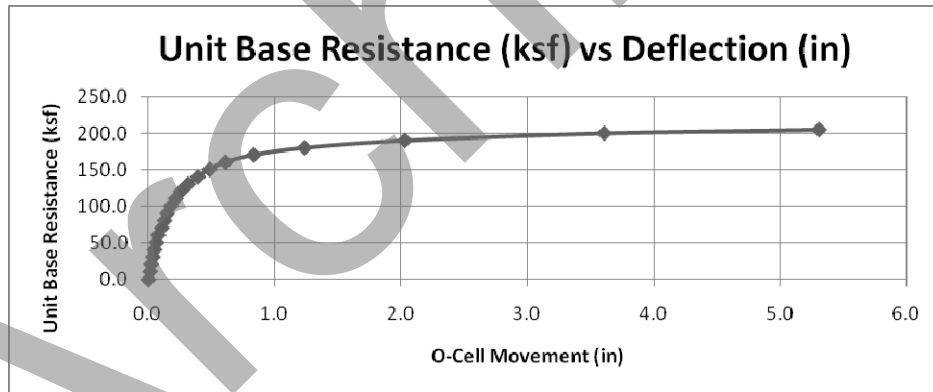
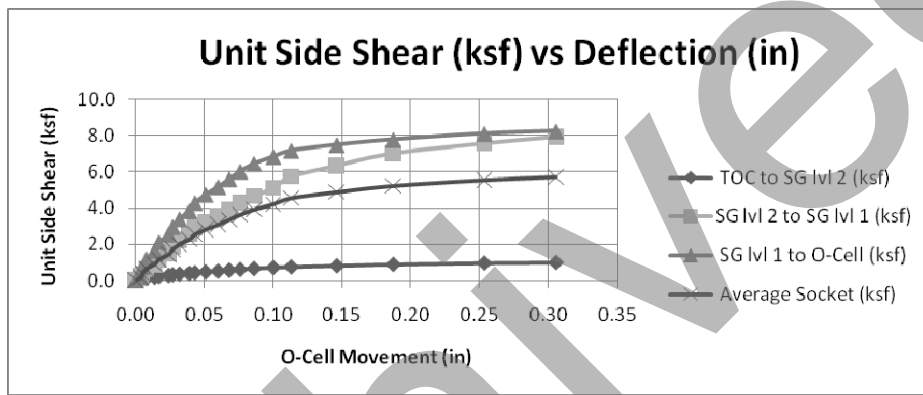
**Shaft Summary**

Shaft Diameter (in)	Shaft Length (ft)	Shaft Length Below O-cell (ft)	Shaft Length Above O-cell (ft)	O-cell Size (in)	Max Net Load (kips)	Max Deflection Up (in)	SS Creep Load (kips)	EB Creep Load (kips)
48.0	42.0	0.67	38.8	21.25	2619.53	0.30	2480	1300

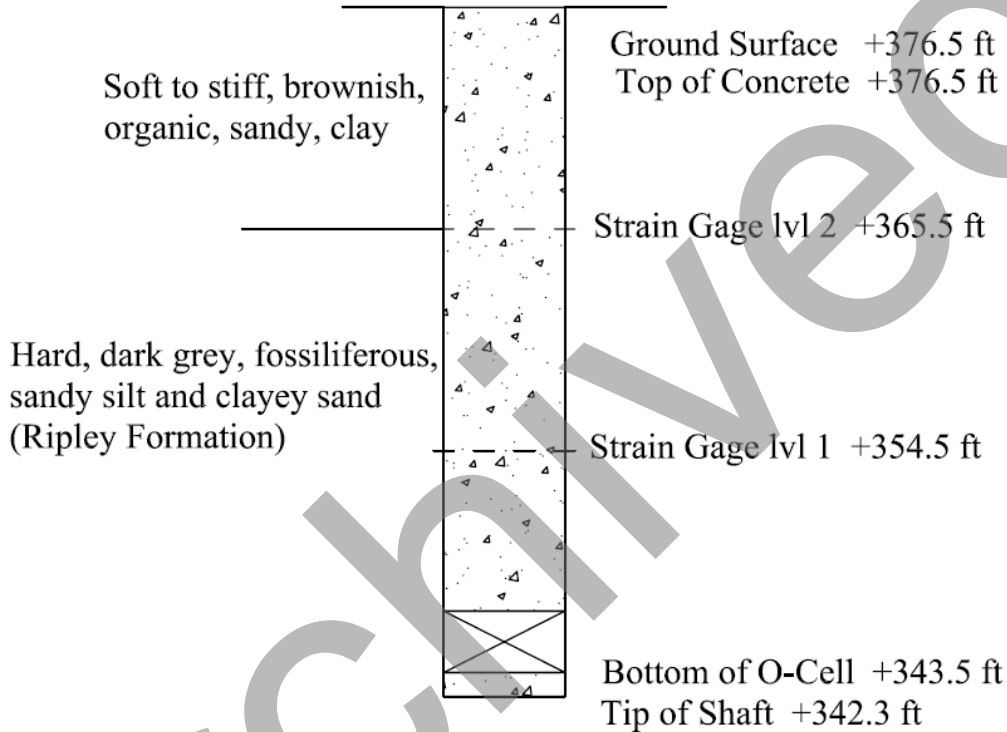


**Data Summary**

Elevation (ft.)	Average $S_u$ (ksf)	Avg. $\phi$ (°)	Unit EB (ksf)	EB Deflection (in)	Unit SS (ksf)	SS Deflection (in)
482.5	1.5	19				
480.0					0.8	0.305
464.0	9.00	0			7.7	
458.0					8.4	
457.8	9.00	0				
441.2						
440.5			202.8	5.308		



The dedicated test shaft was constructed on May 28, 2003. The 48-in test shaft was constructed dry to a total length of 34.2 ft. An auger was used for drilling and cleaning the shaft. After cleaning the base, approximately four linear feet of concrete was delivered to the base of the shaft by freefall. The reinforcing cage with attached O-cell assembly was then inserted into the excavation and into the wet concrete, and temporarily supported by a boom truck with the base of the O-cell at elevation +342.5 ft. Concrete continued to be delivered by freefall until the top of the concrete reached an elevation of +376.5 ft. No unusual problems occurred during the construction of the test shaft.

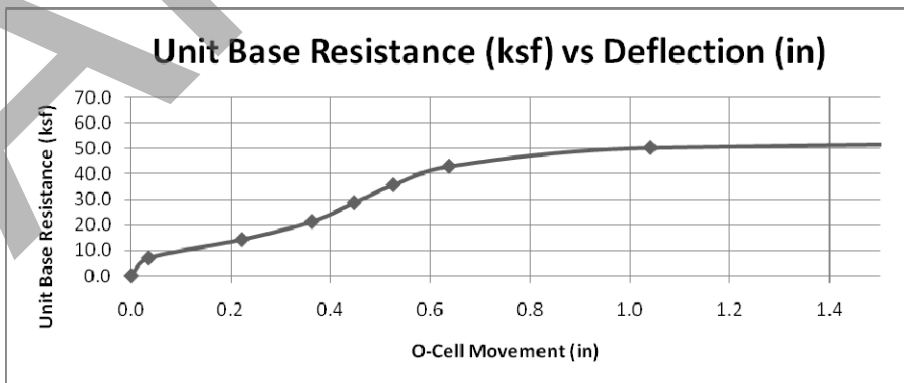
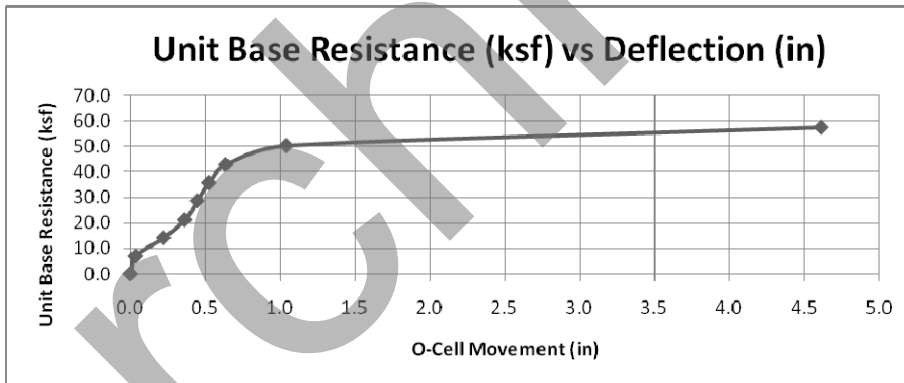
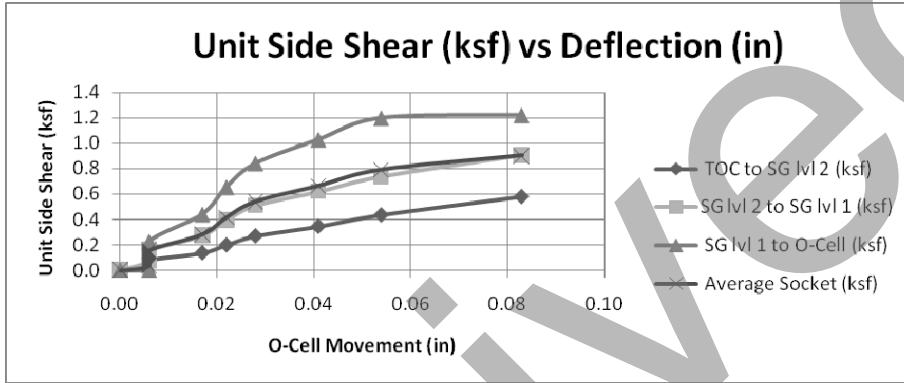


**Shaft Summary**

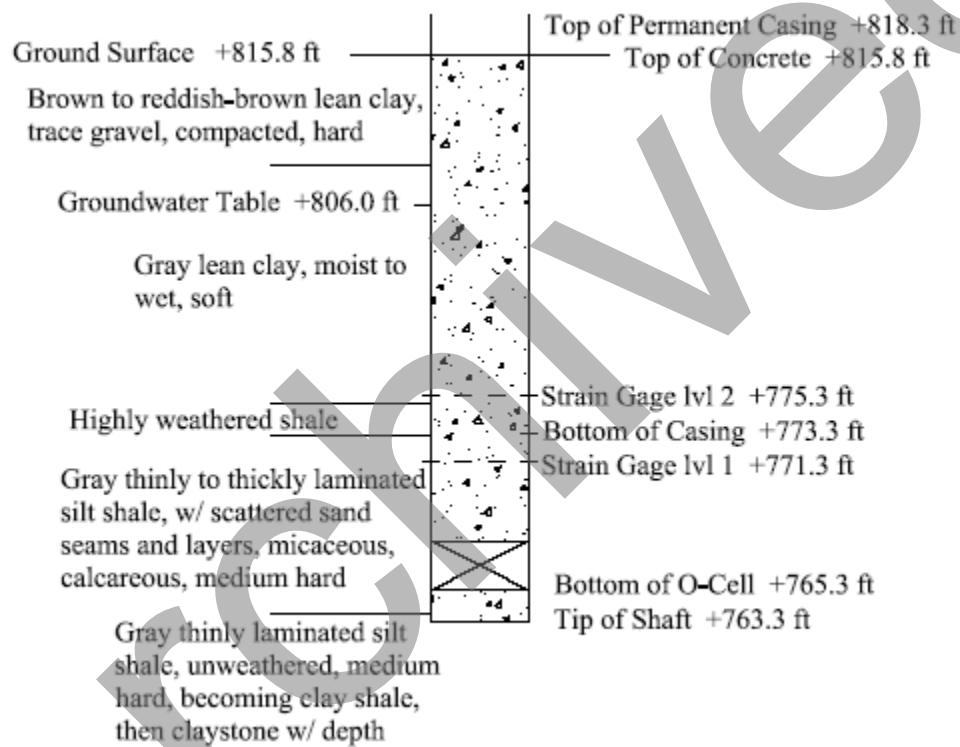
Shaft Diameter (in)	Shaft Length (ft)	Shaft Length Below O-cell (ft)	Shaft Length Above O-cell (ft)	O-cell Size (in)	Max Net Load (kips)	Max Deflection Up (in)	SS Creep Load (kips)	EB Creep Load (kips)
48.0	34.2	1.2	33.0	21.25	3263.00	0.17	0.00	1400.00

**Data Summary**

Elevation (ft.)	Average $S_u$ (ksf)	Avg. $\phi$ (°)	Unit EB (ksf)	EB Deflection (in)	Unit SS (ksf)	SS Deflection (in)
376.5	1.00	0			0.1	0.157
365.5	9.00	0			8.8	
354.5					12.9	
343.5						
342.3			221	2.241		



The dedicated test shaft was constructed between August 26, 2004 and August 27, 2004. The shaft was started by pre-drilling through the clay layer with an auger under polymer slurry. A 54-in O.D. casing was then inserted into the over-drilled shaft and sealed into the highly weathered shale. The polymer slurry was pumped out of the shaft and the rock socket was drilled using a 48-in auger, in the dry condition, to a tip elevation of +763.3 ft. The shaft was then flooded with water in order to perform subsequent shaft caliper test confirming nominal 48-in rock socket diameter. The carrying frame with attached O-cell assembly was inserted into the excavation and temporarily supported from the steel casing. Concrete was then delivered by pump through a pipe into the base of the shaft until the top of the concrete reached an elevation of +815.8 ft. The casing was left in place during testing to isolate the lower side shear provided by the rock socket. No unusual problems occurred during the construction of the shaft.

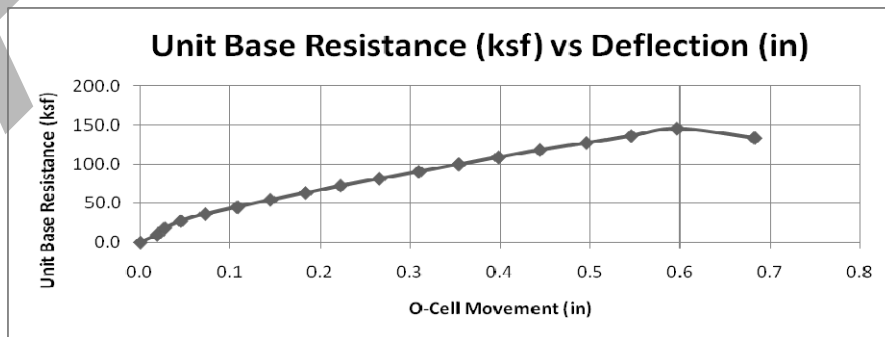
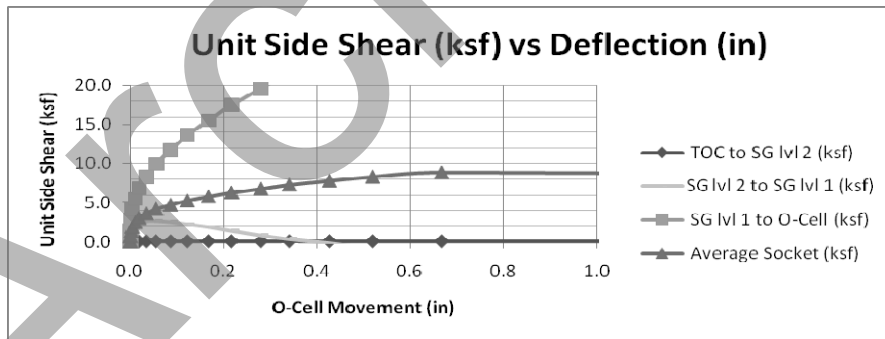
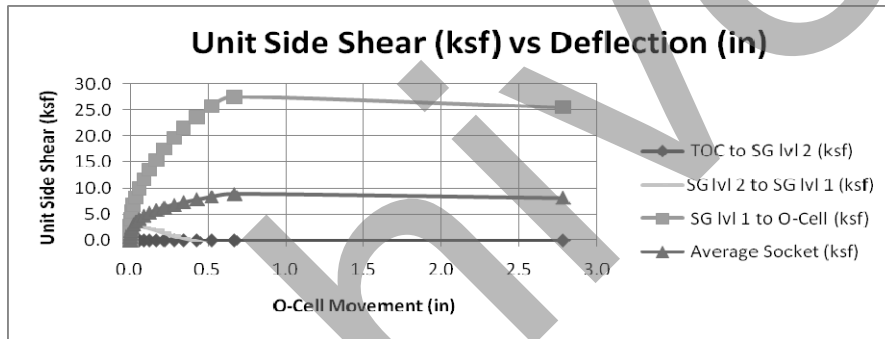


**Shaft Summary**

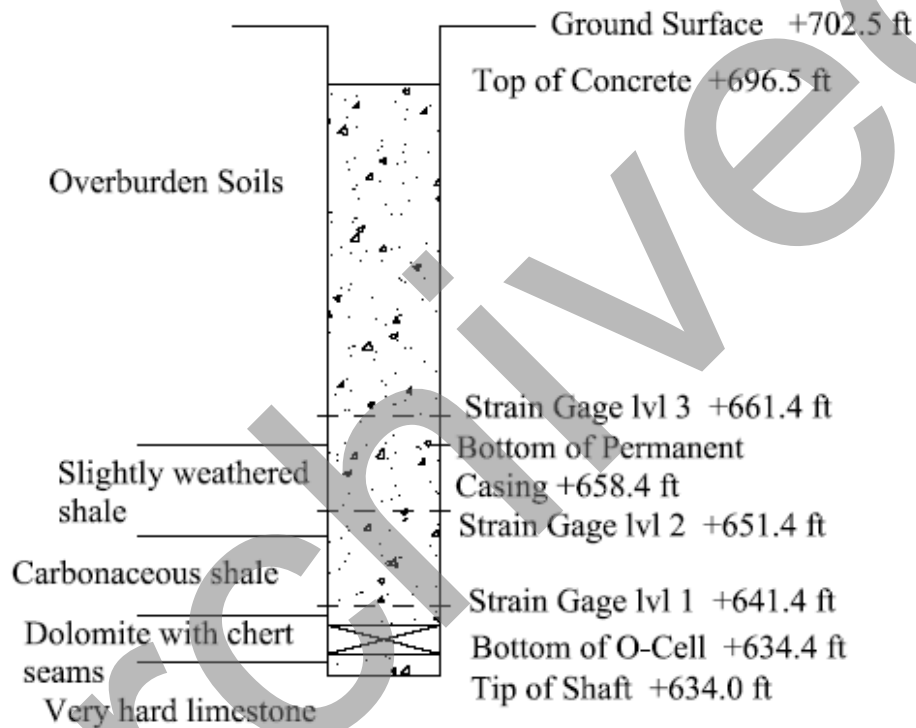
Shaft Diameter (El. +818.3 - +773.3) (in)	Shaft Diameter (El. +773.3 - 763.3) (in)	Shaft Length (ft)	Shaft Length Below O-cell (ft)	O-cell Size (in)	Max Net Load (kips)	SS Creep Load (kips)	EB Creep Load (kips)
54.0	48.0	52.5	2.0	21.0	2053.0	1400.0	N/A

**Data Summary**

Elevation (ft.)	SPT "N" (Blows / ft)	Average $q_u$ (ksf)	Rock Core Recovery (%)	Unit EB (ksf)	EB Deflection (in)	Net Unit SS (ksf)	SS Deflection (in)
815.3							0.67
775.3							
773.3	73 in 6"					15.3	
771.3							
769.9		258.6	90				
765.5		28.2	100				
765.3				133.80	0.60		
763.3	73 in 4"						
758.3		63.6	100				
753.1	73 in 3"	68.0	100				
748.3		42.0	94				
743.3	73 in 3"	60.8	86				



The production test shaft was constructed between April 16 and April 17, 2007. The 66-in test shaft was excavated to a tip elevation of +634.0 ft, in the dry. The shaft was started with a 102-in O.D. temporary casing and a 90-in O.D. temporary casing was inserted as the drilling progressed. A 72-in O.D. permanent casing was screwed into the top of rock to seal the shaft. Various sized augers were used for drilling the shaft and socket. The bottom of the shaft was cleaned using a clean-out bucket. After cleaning the base, a seating layer of concrete was placed into the excavation. The reinforcing cage with attached O-cell assembly was inserted into the concrete and temporarily supported from the steel casing. Concrete was then placed into the shaft until the top of the concrete reached an elevation of +696.52 ft. The contractor removed the outer 102-in O.D. casing and the 90-in O.D. casing immediately after concrete placement. No unusual problems occurred during the construction of the drilled shaft.



**Shaft Summary**

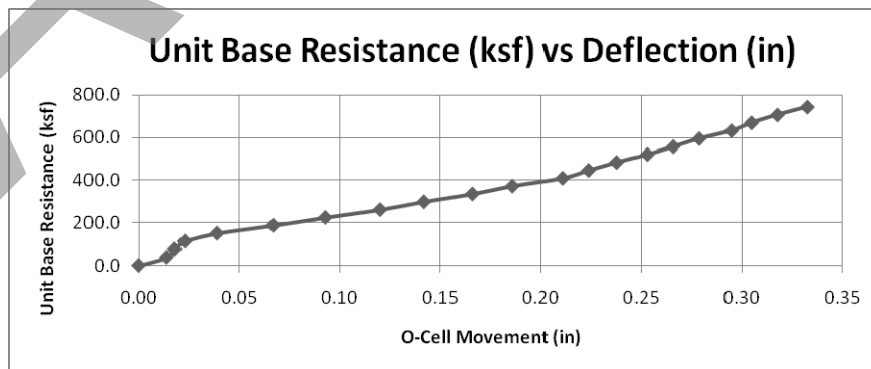
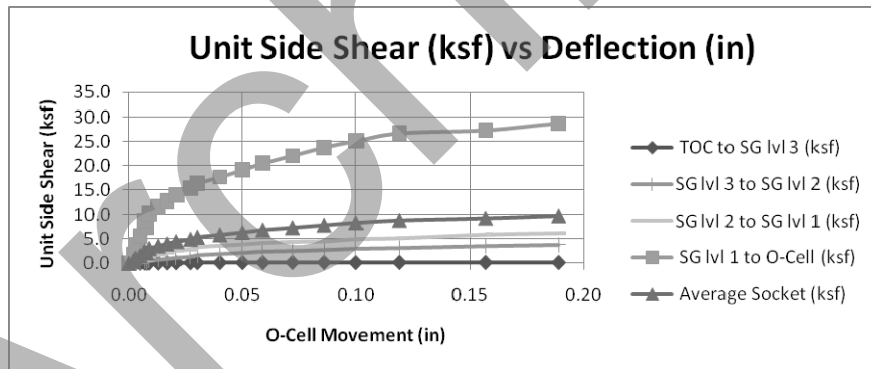
Shaft Diameter (Elev. +696.5 - +658.4)( in)	Shaft Diameter (Elev. +658.4 - +634)( in)	Shaft Length (ft)	Length Below O-cell (ft)	O-cell Size (in)	Max Net Load (kips)	SS Creep Load (kips)	EB Creep Load (kips)
72.0	66.0	62.5	0.4	26.0	5329.0	not reached	not reached

**Data Summary**

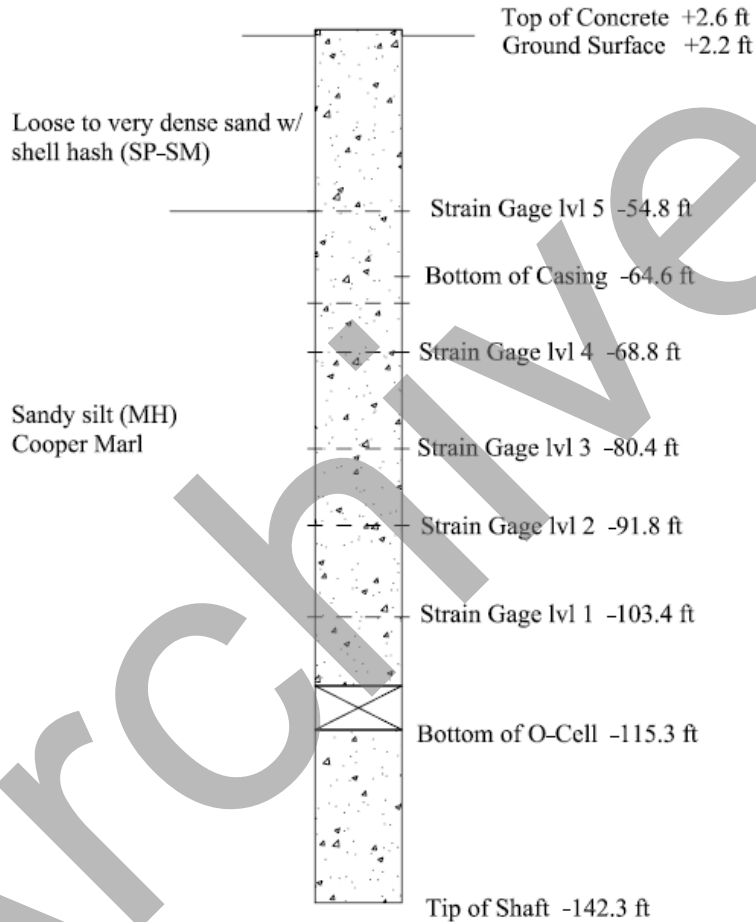
Elevation (ft.)	Rock Core Recovery (%)	RQD (%)	Unit EB (ksf)	EB Deflection (in)	Unit SS (ksf)	SS Deflection (in)
702.5						
696.5					0.20	0.19
661.4					3.70	
658.4						
657.0	88	37				
652.0	100	75				
651.4					6.10	
648.7						
647.0	100	78				
642.0	96	50				
641.4					28.60	
637.0	100	98				
634.4			*546.0			
634.0			**754.0	0.33		
633.9	100	100				

\*Lower Bound assuming a 45° radial fracture forming in the 0.26 ft of concrete below the bearing plate.

\*\*Upper Bound based on a nominal pressure area of the 36-in bearing plate attached to the base of the O-cell assembly.



The production test shaft was constructed on June 12, 2000. The 48-in test shaft was constructed dry with a total length of 144.5 ft. The shaft was started with an O.D. 48-in permanent casing. Both an auger and bucket were used for drilling and cleaning the shaft. Concrete was gravity poured through an O.D. 5-in pipe into the base of the shaft. After the top of the concrete reached an elevation of -114.4 ft, the reinforcing cage was inserted in the shaft and the O-cell was located at an elevation of -115.2 ft. The O.D. pipe was reinserted and concrete was gravity poured into the shaft until it reached an elevation of +2.6 ft. No unusual problems occurred during the construction of the shaft.



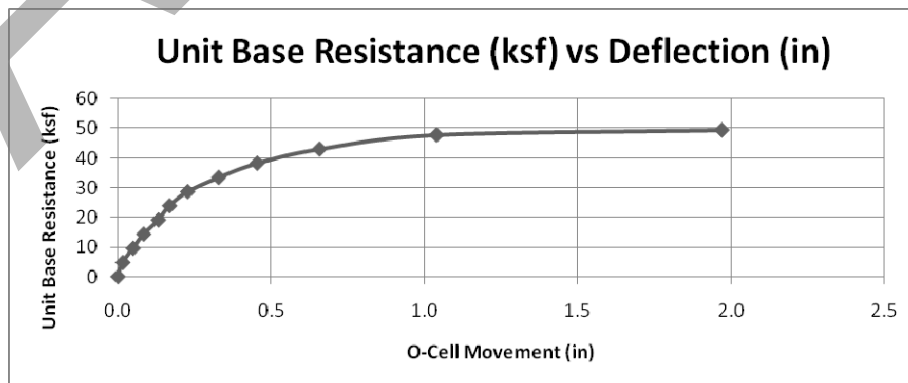
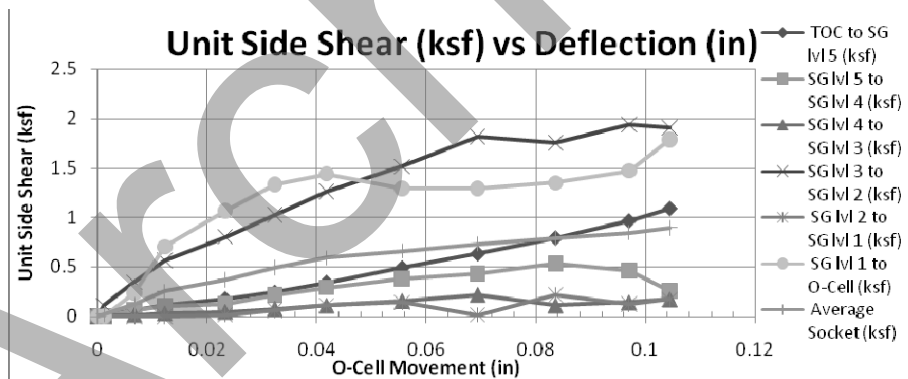
**Shaft Summary**

Shaft Diameter (in)	Shaft Length (ft)	Shaft Length Below O-cell (ft)	Shaft Length Above O-cell (ft)	O-cell Size (in)	Max Net Load (kips)	Max Deflection Up (in)	SS Creep Load (kips)	EB Creep Load (kips)
48.0	144.8	26.5	117.7	26.0	1569.0	0.10	1570.0	850.0



**Data Summary**

Elevation (ft.)	SPT "N" (Blows / ft)	Average $q_u$ (ksf)	Unit Wt. (lb/cu ft)	Unit EB (ksf)	EB Deflection (in)	Unit SS (ksf)	SS Deflection (in)
2.6						1.1	0.1
-41.3	43						
-54.8						0.25	
-57.7		4.1	69				
-63.0	16						
-68.8						0.16	
-72.2	18						
-77.8		4.3	64.2				
-78.1	15						
-80.4						1.91	
-82.7	17						
-87.9	23						
-91.8						0.17	
-93.2	25						
-97.8	23	4.1	61.5				
-103.0	19						
-103.4						2.79	
-112.9	27						
-117.8		5.9	78.9				
-118.1	21						
-142.3				49.4	1.97		



A total of 12 dedicated test shafts were constructed along the 7+ mile long project alignment. Ten of the shafts were for axial load tests, while two of the shafts were for lateral load tests. The shafts were installed to various lengths into the Cooper Marl, utilizing various casing and drilling methods. A list of the axial test shafts is provided in the table below.

**Summary of Test Shafts**  
*From Camp, W.M., Brown, D.A. and Mayne, P.W. (2002)*

Site	Shaft	Dia. (in)	Total Length (ft)	Casing Length (m)	Casing Type	Drilling Fluid	Loading
Mount Pleasant	MP1	96	158.1	58.1	P	bent.	2 level O-cell, lateral w/ liquefaction
	MP2	96	157.0	71.0	T	polymer	2 level O-cell, lateral
	MP3	96	110.0	71.9	P	polymer	O-cell, axial & lateral Statnamic w/ liquef.
	MP4	72	107.0	69.0	P	dry	O-cell, axial Statnamic
Charleston	C1	96	157.3	73.6	P	water	2 level O-cell, lateral, lateral Statnamic
	C2	96	157.5	76.5	P	polymer	2 level O-cell, lateral Statnamic
	C3	96	112.6	72.9	T	polymer	O-cell, axial Statnamic, lateral
	C4	72	108.7	69.0	P	dry	O-cell, axial & lateral Statnamic
Drum Island	DI1	96	158.5	72.6	P	dry	2 level O-cell, lateral Statnamic
	DI2	72	115.2	71.9	P	dry	O-cell, lateral Statnamic

All of the shafts were constructed to bear into the Cooper Marl, a stiff calcareous marine clay that can vary to a silt and contain various amounts of sand and/or shells. Standard Penetration Test N-values in the Cooper Marl can range from the low teens to 50/3". Samples from borings drilled at the test shaft sites had undrained shear strength ( $S_u$ ) values of 2.3 to 5.8 ksf. CU triaxial tests of samples yielded  $c' = 0$  to 1.8 ksf and  $\phi' = 16.7$  to 32.5 degrees.

The results of the O-Cell tests are summarized in the table below. Ultimate unit side shear values in the Cooper Marl ranged from 2.0 to 6.5 ksf. Unit end bearing values ranged from 43.5 to 80 ksf.

**Summary of O-Cell Load Test Results**

Test Shaft	Unit End Bearing (ksf)	Max Deflection Down for EB (in)	Highest Unit Side Shear Cap (ksf)	Max Deflection Up for SS (in)
C-1	79.6	6.20	6.47	0.67
C-2	74.7	5.06	5.83	0.36
C-3	43.5	3.25	2.96	0.04
C-4	50.6	4.31	2.50	0.06
DI-1	58.8	4.94	3.43	1.43
DI-2	56.0	3.38	3.81	0.06
MP-1	74.9	4.50	5.24	1.58
MP-2	68.3	3.75	6.01	0.83
MP-3	54.4	3.73	3.42	0.08
MP-4	63.4	4.22	2.10	0.08

Detailed data on the Cooper Marl and analysis of the load test program is contained in:

Camp, W.M., Brown, D.A. and Mayne, P.W. (2002). "Construction Method Effects on Axial Drilled Shaft Performance", *Proceedings of the International Deep Foundations Congress 2002*, Orlando, FL, ASCE GSP 116, Vol 1, 195-208.

Camp, W.M., Mayne, P.W. and Brown, D.A (2002). "Drilled Shaft Axial Design Values: Predicted Versus Measured Response in a Calcareous Clay", *Proceedings of the International Deep Foundations Congress 2002*, Orlando, FL, ASCE GSP 116, Vol 2, 1518-1532.

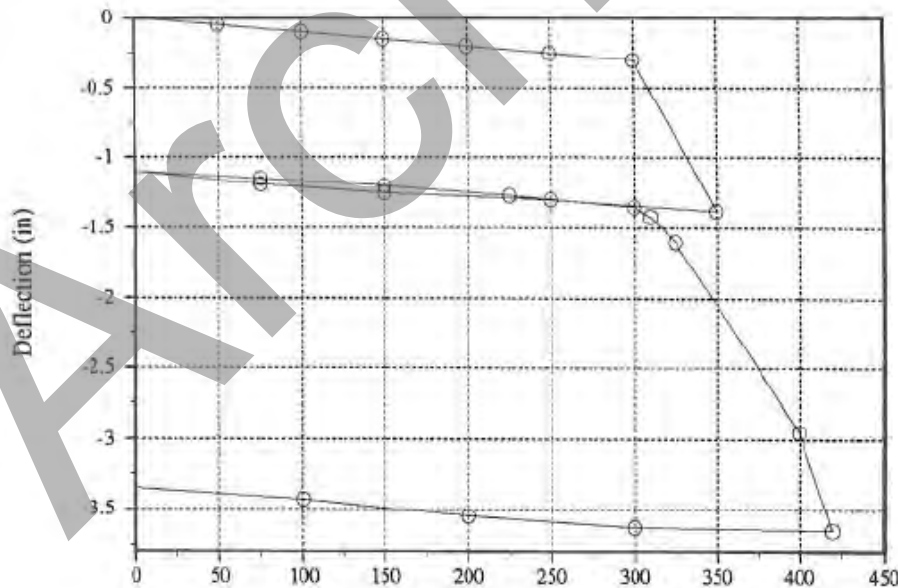
A dedicated test shaft was constructed with a 10-foot socket into the Cooper Marl formation. A permanent casing was used to isolate the shaft from the overburden above the Cooper Marl. The shaft was constructed in the dry using a temporary casing. There were no unusual problems during the construction of the test shaft.

**Shaft Summary**

Shaft Diameter (in)	Shaft Length (ft)	Max Net Load (kips)	Max Deflection Down (in)	Unit EB Cap (ksf)
24.0	150.0	1680.00	1.10	57.1

**Data Summary**

Material	Location	Average $q_u$ (ksf)	Unit EB (ksf)	EB Deflection (in)	Unit SS (ksf)	SS Deflection (in)
Cooper Marl	Socket	2.9			3.6	0.15
Cooper Marl	Base	2.9	18.00	0.24		
Cooper Marl	Base	2.9	27.00	0.48		
Cooper Marl	Base	2.9	28.56	1.10		



**Figure A-26 - Load-deflection curve, Shaft #1, Mt. Pleasant, SC**

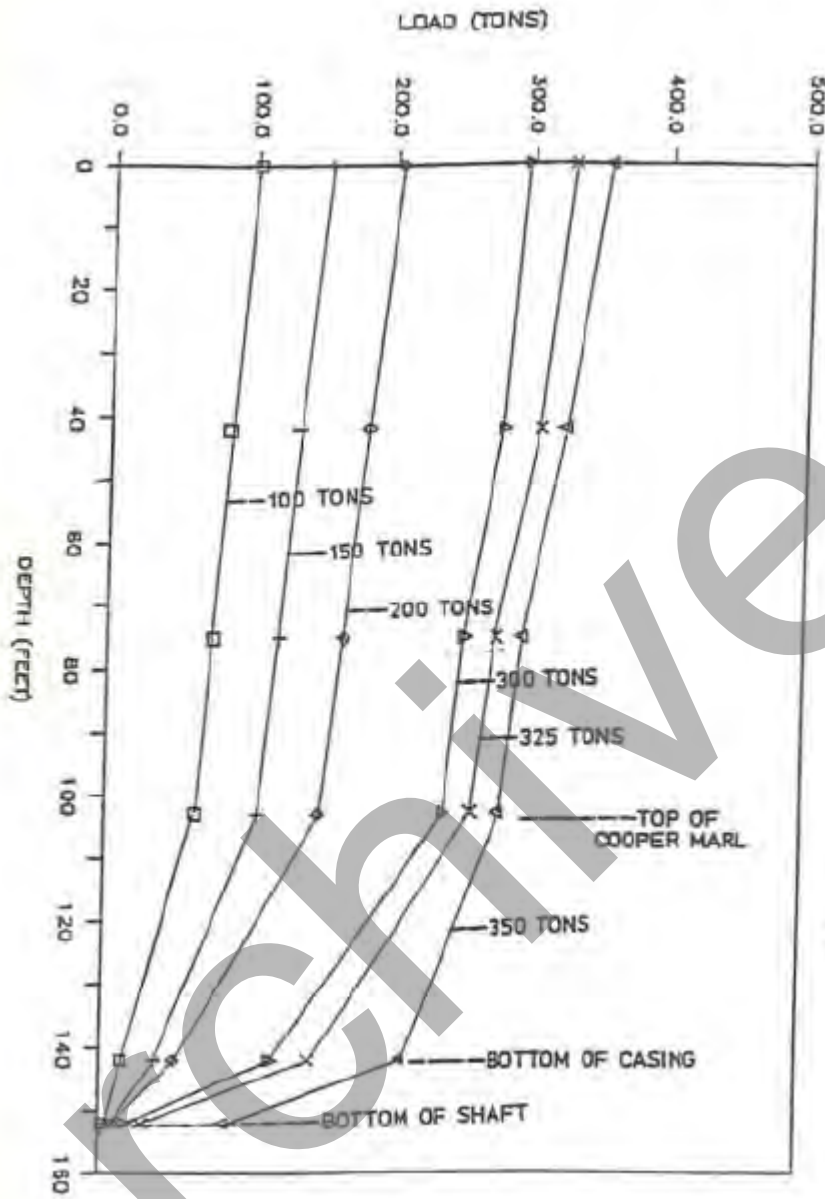


Figure A-27 - Load transfer distribution, Shaft #1, Mt. Pleasant, SC

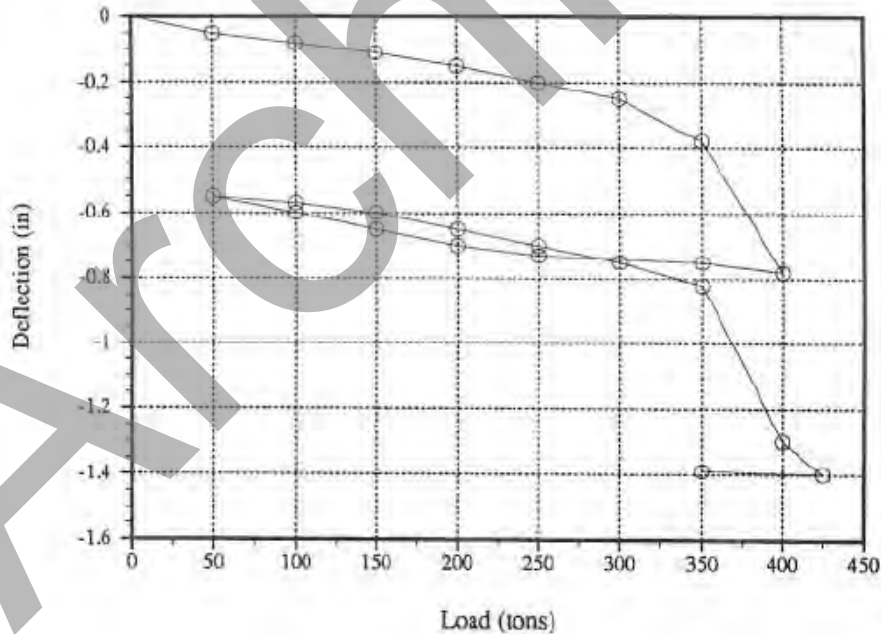
A dedicated test shaft was constructed with a 23-foot socket into the Cooper Marl formation. A permanent casing was used to isolate the shaft from the overburden above the Cooper Marl. The shaft was constructed in the dry using a temporary casing. There were no unusual problems during the construction of the test shaft.

**Shaft Summary**

Shaft Diameter (in)	Shaft Length (ft)	Max Net Load (kips)	Max Deflection Down (in)	Unit EB Cap (ksf)
24.0	137.0	1700.00	0.50	20.0

**Data Summary**

Material	Location	Average $q_u$ (ksf)	Unit EB (ksf)	EB Deflection (in)	Unit SS (ksf)	SS Deflection(in)
Cooper Marl	Socket	2.9			3.60	0.10
Cooper Marl	Base	2.9	18.00	0.24		
Cooper Marl	Base	2.9	20.00	0.50		



**Figure A-30 - Load-deflection curve, Shaft #2, Mt. Pleasant, SC**

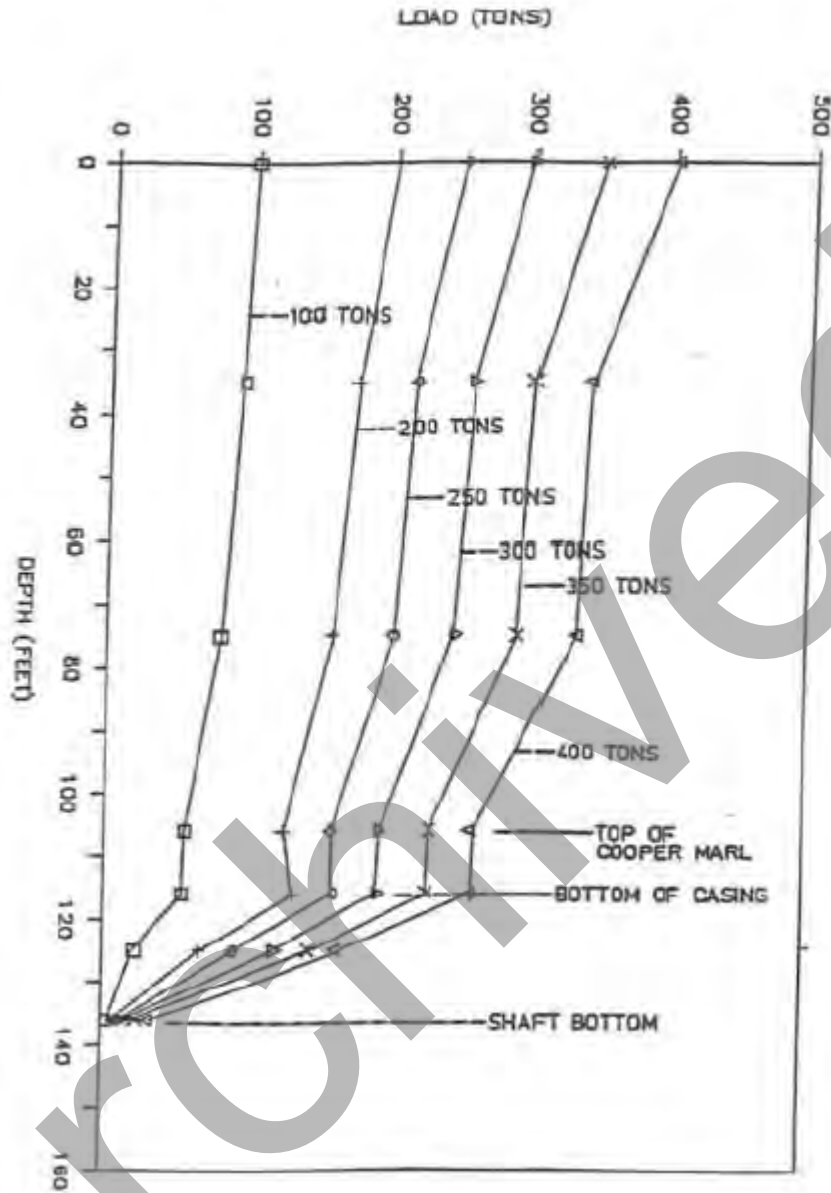
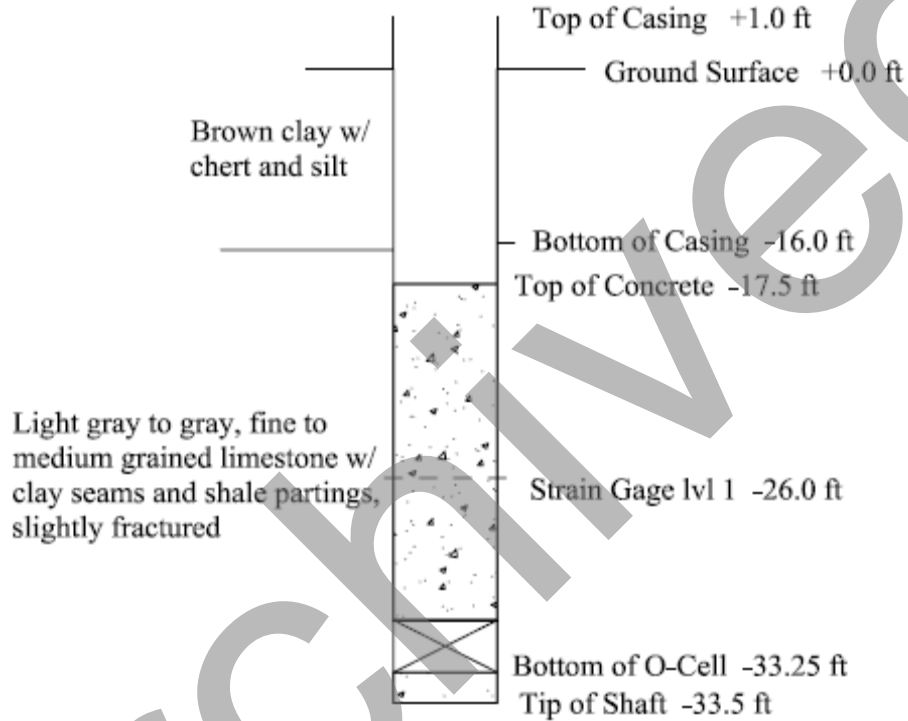


Figure A-31 - Load transfer distribution, Shaft #2, Mt. Pleasant, SC

The test shaft was constructed on September 17, 2008. The shaft was constructed dry to the tip elevation. The rock socket was cored with a core barrel. No unusual problems occurred during construction of the test shaft.



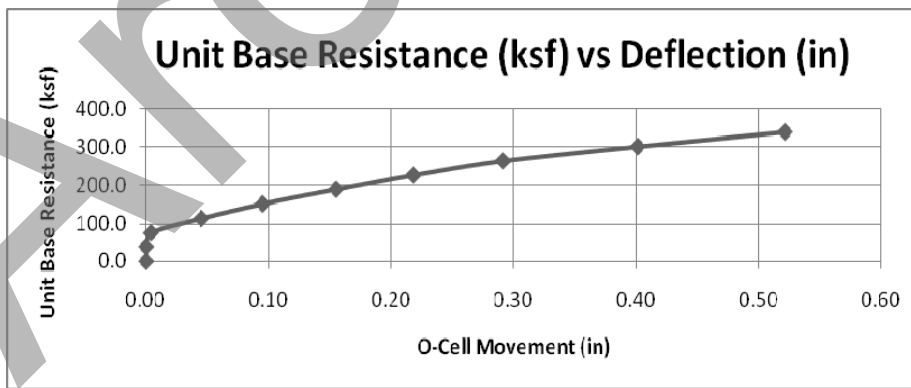
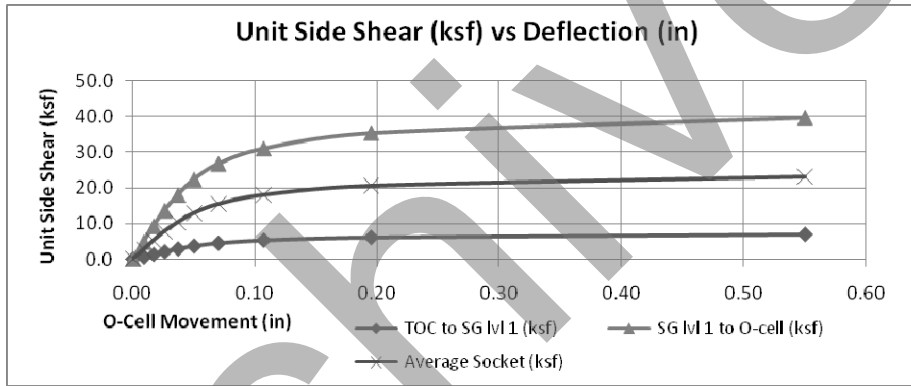
**Shaft Summary**

Shaft Diameter (in)	Shaft Length (ft)	Shaft Length Below O-cell (ft)	O-cell Size (in)	Max Net Load (kips)	SS Creep Load (kips)	EB Creep Load (kips)
48.0	16.0	0.2	34.0	4354.0	3840.0	3950.0

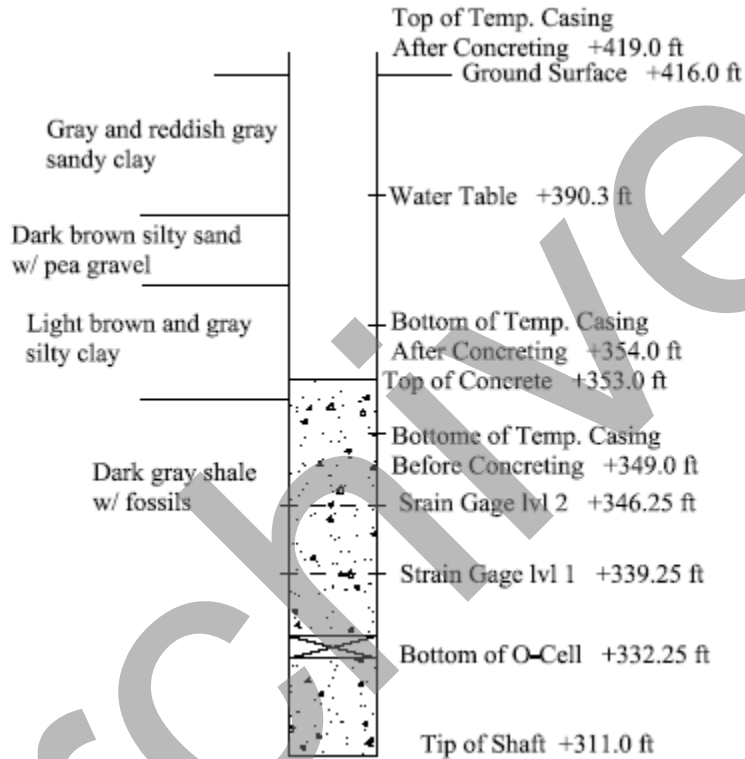


**Data Summary**

Depth (ft.)	Average $q_u$ (ksf)	Rock Core Recovery (%)	Rock Core RQD	Unit EB (ksf)	EB Deflection (in)	Unit SS (ksf)	SS Deflection (in)
0.0							
-16.0							
-16.5	2319.8	100	64				
-17.5							
-23.3	963.4	100	64			6.9	0.55
-26.0							
-26.3	979.2	100	65				
-33.3				340.66	0.52	39.7	
-33.5							
-35.8	819.4	100	65				
-36.0							



The test shaft was completed on February 24, 2005. The test shaft was excavated dry to a tip elevation of +311.0 ft. The shaft was started with a 32-in O.D. temporary surface casing. The casing was inserted after pre-drilling to elevation +349 ft. An auger was used for drilling the shaft. The bottom of the shaft was cleaned with an auger. A seating layer of concrete was placed in the base of the shaft by gravity pour. The O-cell and attached instrumentation were inserted in the shaft and into the wet concrete. The remainder of the concrete was placed by free fall through a tremie pipe until the top of the concrete reached an elevation of +353 ft. After concreting, the casing was pulled up so that its tip was above the concrete level. No unusual problems occurred during the construction of the shaft.

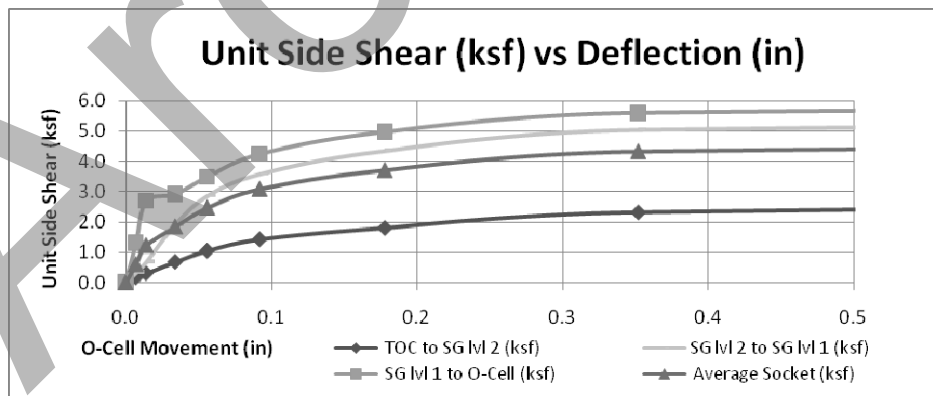
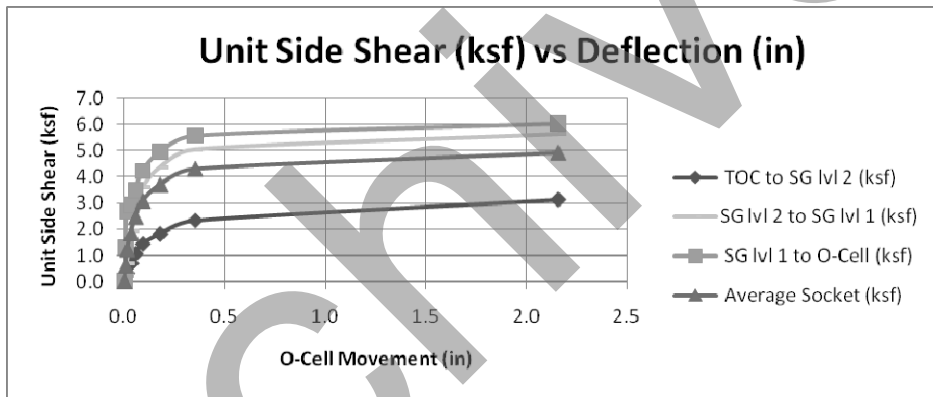


**Shaft Summary**

Shaft Diameter (El. +416 - +349) ( in)	Shaft Diameter (El. +349 - +311) ( in)	Shaft Length (ft)	Shaft Length Below O-cell (ft)	O-cell Size (in)	Max Net Load (kips)	SS Creep Load (kips)	EB Creep Load (kips)
32.0	30.0	105.0	21.3	21.0	829.0	460.0	0.0

**Data Summary**

Elevation (ft.)	Average $q_u$ (ksf)	Rock Core Recovery (%)	Unit EB (ksf)	EB Deflection (in)	Unit SS (ksf)	SS Deflection (in)
416.0						
353.0					3.11	2.16
346.3					5.58	
339.3						
332.3						
324.0	16.10	100			6.20	
315.0	27.40	100				
312.0		100				
311.0			Negligible	0.11		
301.0	37.80	100				
293.0	40.00	100				
281.0	41.50	100				
274.0	52.00	100				
261.0	55.90	100				



Archived

This page is intentional left blank.

**APPENDIX F**

**SAMPLE DRILLED SHAFT  
INSPECTION CHECKLIST**

Archived

Archived

This page is intentional left blank.

## Sample Drilled Shaft Inspector's Checklist

<b>Contractor and Equipment Arrive on Site</b>	<b>YES</b>	<b>NO</b>	<b>N/A</b>
1. Has the Contractor submitted a Drilled Shaft Installation Plan?			
2. Has the Drilled Shaft Installation Plan been approved?			
3. Does Contractor have an approved concrete mix design?			
4. Has Contractor run the required Trial Mix and slump loss test for their concrete mix design?			
5. If concreting is estimated to take over two hours, has Contractor performed a satisfactory slump loss test for the extended time period?			
6. If Contractor proposed a mineral or polymer slurry, do they have an approved Slurry Management Plan?			
7. Have you attended pre-construction conference with the Engineer and Contractor for clarification of drilled shaft installation procedures and requirements?			
8. Is Contractor prepared to take soil samples or rock cores on the bottom of the shaft, if required in the Contract Documents?			
9. Has the Contractor met the requirements for protection of existing structures?			
10. Has the site preparation been completed for footing?			
11. Does Contractor have all the equipment and tools shown in the Drilled Shaft Installation Plan?			
12. If casing is to be used, is it the right size?			
13. If Contractor plans to use a slurry, do they have the proper equipment to mix it?			
14. Is the slurry manufacturer's representative on site at the start of slurry work?			
15. If a slurry desander is required, does Contractor have it on site and operational?			
16. Does Contractor's tremie meet the requirements of the Specifications?			
17. Do you have all the drilled shaft forms that are needed during shaft construction?			
18. Do you understand all of the forms? (If not, contact Engineer for assistance.)			
<b>Technique Shaft</b>			
19. Is the technique shaft positioned at the approved location?			
20. Has Contractor performed a successful technique shaft as specified?			
21. Did Contractor cut off the technique shaft below grade as specified?			
22. Has Contractor revised the procedures and equipment (and the revision approved) to successfully construct a shaft?			
<b>Shaft Excavation and Cleaning</b>			
23. Is the shaft being constructed in the correct location and within tolerances?			
24. Does Contractor have a benchmark for determination of the proper elevations?			
25. If core holes are required, has Contractor taken them in accordance with the Specifications?			
26. If a core hole was performed, was a Rock Core form completed and did Contractor maintain a log?			
27. If Contractor is using slurry, did they perform tests and report results in accordance with the Specifications?			
28. Is the slurry level being properly maintained at the specified level?			
29. Are the proper number and types of tests being performed on the slurry?			

30. Are you filling out the Soil and Rock Excavation forms?			
31. If permanent casing is used, does it meet requirements of Contract Documents?			
32. If temporary casing is used, does it meet the requirements of the Specifications?			
33. If bellng is required, does it meet the requirements of the Contract Documents?			
34. Is the shaft within allowable vertical alignment tolerance?			
35. Is the shaft of proper depth?			
36. Does the shaft excavation time meet the specified time limit?			
37. If over-reaming is required, was it performed in accordance with Specifications?			
38. Does the shaft bottom condition meet the requirements of the Specification?			
39. Did you complete the Drilled Shaft Inspection form?			
<b>Reinforcing Cage</b>			
40. Is the rebar the correct sizes and configured in accordance with the project plans?			
41. Is the rebar properly tied in accordance with the Specifications?			
42. Does Contractor have the proper spacers for the steel cage?			
43. Does Contractor have the proper amount of spacers for the steel cage?			
44. If steel cage was spliced, was it done in accordance with Contract Documents?			
45. Is the steel cage secured from settling and from floating?			
46. Is the top of the steel cage at proper elevation in accordance with Specifications?			
<b>Concrete Placement</b>			
47. Prior to concrete placement, has the slurry (both manufactured and natural) been tested in accordance with the Specifications?			
48. If required, was the casing removed in accordance with the Specifications?			
49. Was the discharge end of the tremie maintained at the specified minimum embedment in the concrete			
50. If free-fall placement (dry shaft construction only), was concrete place in accordance with the Specifications?			
51. Did concrete placement occur within the specified time limit?			
52. Are you filling out the Concrete Placement and Volume forms?			
53. Did Contractor overflow the shaft until good concrete flowed at the top of shaft?			
54. Were concrete acceptance tests performed as required?			
<b>Post Installation</b>			
55. If shaft is constructed in open water, is the shaft protected for seven days or until the concrete reaches a minimum compressive strength of 2500 psi?			
56. Is all casing removed to the proper elevation in accordance with Specifications?			
57. If required, has Contractor complied with requirements for Integrity Testing?			
58. Is the shaft within the applicable construction tolerances?			
59. Has the Drilled Shaft Log been completed?			
60. Have you documented the pay items?			
<b>Notes/Comments:</b>			



## SAMPLE INSPECTOR'S "TOOLS"

### CHECKLIST

#### Approved Job Information

- Project Plans & Specifications w/ Revisions
- Special Provisions & Technical Special Provisions
- Drilled Shaft Installation Plan

#### References

- Standard Specifications
- Drilled Shaft Inspector's Manual (Local Department)
- Drilled Shaft Inspector's Qualification Course manual (NHI #132070)

#### Testing Equipment

- Sampler
- Sand Content Testing Equipment
- Mud Density Test Equipment
- Viscosity Test Equipment

#### Blank Forms

- Drilled Shaft Soil/Rock Excavation Log
- Drilled Shaft Rock Core Log
- Drilled Shaft Inspection Log
- Concrete Placement Log
- Concrete Volume Form
- Drilled Shaft Log
- Drilled Shaft Construction & Pay Summary

#### Daily Essentials

- Hard Hat
- Boots
- Ear & Eye Protection
- Pen/Pencil (with spare)
- 12' Tape (Perferably 25')
- 150' Tape
- Builders Square
- Life Jacket or reflective jacket
- Watch
- Calculator
- Camera
- Scale
- Level
- Weighted Tape (100')
- Plumb bob

SAMPLE

<b>PLANS AND SPECIFICATIONS CHECKLIST</b>			
The Inspector needs to be able to locate the following in the Plans and Specifications and be familiar with them before the job commences. <b>These documents should be with you at the job site and all times for reference.</b>			
<b>YES</b>	<b>NO</b>	<b>PLANS</b>	
		Revisions	
		Key Sheets	
		Construction Estimate Sheet	
		Plan/Profile Sheets	
		Traffic Control Plans	
		Drainage Plans	
		Utility Adjustments	
<b>YES</b>	<b>NO</b>	<b>STRUCTURES PLANS</b>	
		General Notes	
		Report of Core Borings	
		Foundation layout	
		Details	
		Bridge Hydraulic Sheet	
<b>YES</b>	<b>NO</b>	<b>SPECIFICATIONS</b>	
		Technical Special Provisions	
		Standard Specifications	
		Supplemental Specs	
		Drilled Shaft Installation Plan	

**SAMPLE - SUMMARY OF DRILLED SHAFT INSTALLATION PLAN**

a. Name of Drilled Shaft Superintendent _____ Experience _____ _____			FHWA Pub. IF-99-025 xxx.12 (a)
B. EQUIPMENT	MANUFACTURER	MODEL	SIZE
Drill Rig			
Crane			
Augers			
Casing			
Bailing Bucket			
Final Cleaning Equipment			
Desanding			
Slurry Pump			
Core Sampling Equipment			
Concrete Pump			
c. Sequence of Construction: How many crews _____ How many shafts _____		c. Sequence of Shaft Construction: Bents of Shaft groups _____	
<b>d. Details of Shaft Excavation Methods</b>			
e. Details of Slurry: Type _____ Methods to mix/circulate _____ Desand _____ Testing _____ Name of Lab _____			
<b>f. Details of method to clean Shafts after initial excavation:</b>			
<b>g. Details of Shaft reinforcement:</b>			
h. Details of Concrete placement procedures: Concrete or Pump tremie _____ Initial placement _____ Raising during placement _____ Overfilling shaft _____ Provisions to ensure final shaft Cutoff Elevation: _____			
<b>i. Details of casing Removal:</b>			
1. Required Submittals: Shaft Drawings _____ Concrete Mix Design _____			
2. Details of Load Test: Equipment _____ Procedure _____ Calibration for Jacks or Leadol's _____			
3. Prevention of Displacement of Casing/Shafts during Placement Compaction of Fill _____ Method _____ Equipment _____			
4. Environmental control procedures to prevent loss of slurry or concrete into waterways:			
5. Other information:			

**SAMPLE**

DRILLED SHAFT SOILD EXCAVATION LOG (ENGLISH/METRIC)						
Project Name _____				Page _____ of _____		
Project No _____				Pier No. _____		
Contractor _____				Shaft No. _____		
Inspected By _____			Date _____	Station _____		
Approved By _____			Date _____	Offset _____		
ID	OD	Casting Information			Soil Auger Diam. _____	
		Top Elev.	Length	Bot. Elv.	Gmd. Suif Elev. _____	
		_____	_____	_____	_____	Water Table Elev. _____
		_____	_____	_____	_____	Reference Elev. _____
		_____	_____	_____	_____	Drilling Mud _____
Notes _____						

Depth	Elev.	Time		Soil Description & Notes
			In	
			Out	
			In	
			Out	
			In	
			Out	
			In	
			Out	
			In	
			Out	
			In	
			Out	
			In	
			Out	
			In	
			Out	
			In	
			Out	
			In	
			Out	
			In	
			Out	
			In	
			Out	

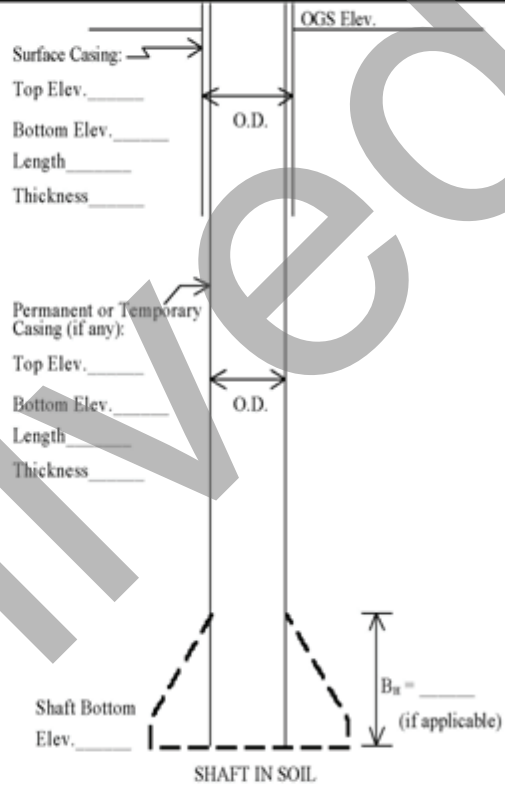


## SAMPLE

	<b>GEOTECHNICAL ENGINEERING BUREAU DRILLED SHAFT IN SOIL - FIELD RECORD</b>	
	STRUCTURE _____	
	SHAFT NUMBER _____	DATE _____

PROJECT STAMP

Date Excavation Started _____	Finished _____	
Date Bottom Observed _____		
Date Concrete Placed _____		
	DESIGN	AS-BUILT
Station _____		
Offset _____		
Top Elevation _____		
Bottom Elevation _____		
Shaft Diameter _____		
Shaft Length _____		
Bell Diameter (if appl.) _____		
Bell Height $B_b$ (if appl.) _____		
Plumbness _____		
Design Capacity _____		
Observed Groundwater Elevation _____		
Remarks: _____		



Date	Time	Depth	Soil or Rock Description	Tool	Observations

**SAMPLE  
DRILLED SHAFT INSPECTION  
(ENGLISH/METRIC)**

Project Name _____	Page _____ of _____
FIN Project No. _____	Pier No. _____
Contractor _____	Shaft No. _____
Inspected By _____ Date _____	Station _____
Approved By _____ Date _____	Offset _____

Inspection By: \_\_\_\_\_ Visual  
 \_\_\_\_\_ Sounding  
 Time Stated \_\_\_\_\_  
 Time Finished \_\_\_\_\_

12:00

Job North A \_\_\_\_\_

9:00

3:00

Comments

Recommendations

\_\_\_\_\_  
 \_\_\_\_\_

\_\_\_\_\_  
 \_\_\_\_\_

6:00

Results: \_\_\_\_\_ Satisfactory  
 \_\_\_\_\_ Unsatisfactory

Given to \_\_\_\_\_ Verbal/Written  
 By \_\_\_\_\_ Time \_\_\_\_\_ Date \_\_\_\_\_



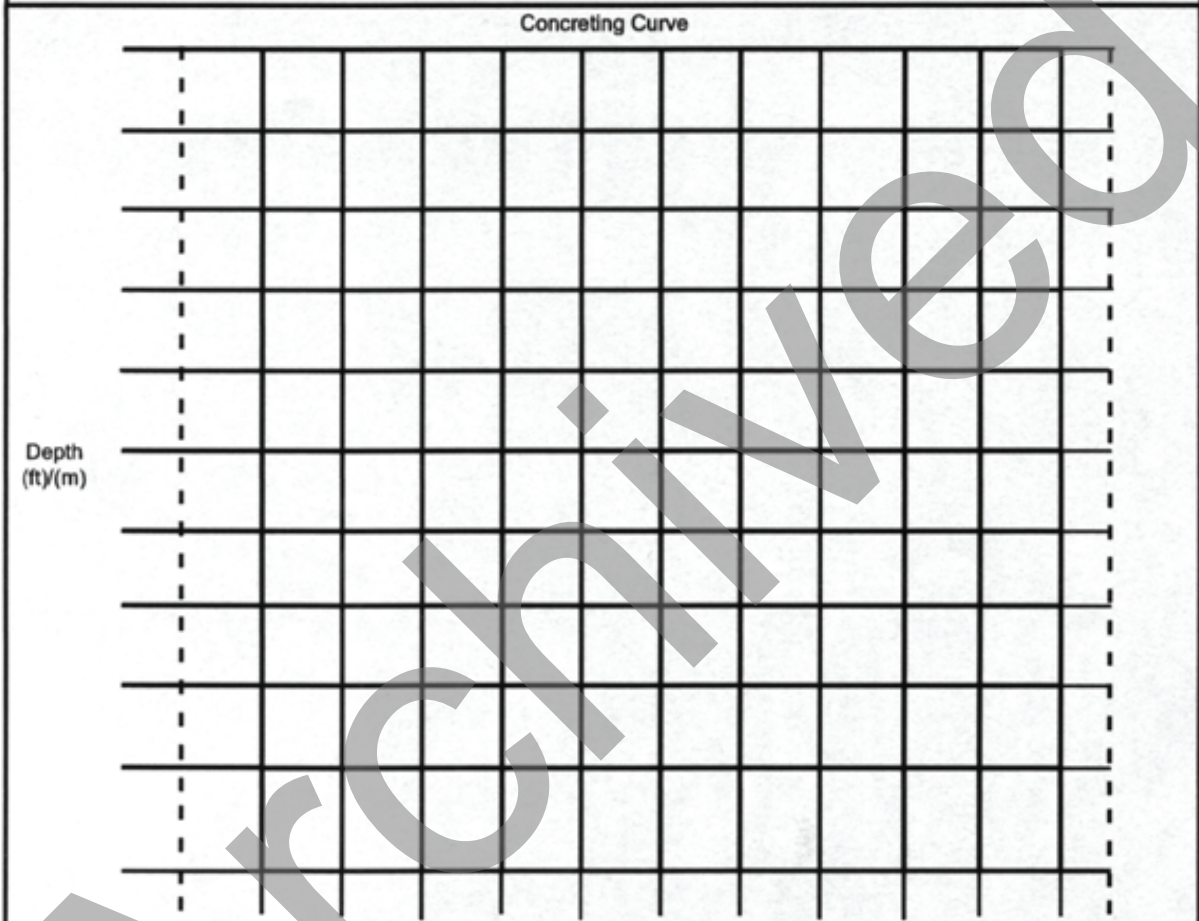


# SAMPLE

## DRILLED SHAFT CONCRETE VOLUMES (ENGLISH/METRIC)

CONSTRUCTION  
1100  
Page 2 of 2

Project Name _____	Page _____ of _____
FIN Project No. _____	Pier No. _____
Contractor _____	Shaft No. _____
Inspected By _____ Date _____	Station _____
Approved By _____ Date _____	Offset _____



Volume Delivered	VD _____	cy/m <sup>3</sup>	Lineal Volume of Rebar, Telltales, etc. AR (#bars) (As) + (#) (At) = ( ) ( si) + ( ) ( si) = _____ s
Volume in Lines	VL _____	cy/m <sup>3</sup>	(#bars) (As) + (#) (At) = ( ) ( m <sup>2</sup> ) + ( ) ( m <sup>2</sup> ) = _____ m <sup>2</sup>
Wastage	VW _____	cy/m <sup>3</sup>	Rock Socket Length RSL _____ ft/m
Volume Placed = VD-VL-VW =	VP _____	cy/m <sup>3</sup>	Est. Rock Socket Volume From Curve VRS _____ cy/m <sup>3</sup>
Theoretical Vol.	VT _____	cy/m <sup>3</sup>	Act. Rock Socket Volume VRS' = VRS + (AR) (RSL) - V1 ( cy) + ( si) ( ft) / (3888) - ( cy) = _____ cy
Overpour(VP-VT)	OP _____	cy/m <sup>3</sup>	( m <sup>3</sup> ) + ( m <sup>2</sup> ) ( m) - ( m <sup>3</sup> ) = _____ m <sup>3</sup>
			Avg. Rock Socket Dia. = SQRT[VRS' / (0.7854) (RSL)]
			SQRT[(4950) ( cy) / ( ft)] = _____ in
			SQRT[(1.273) ( m <sup>3</sup> ) / ( m)] = _____ m

**DRILLED SHAFT CONSTRUCTION & PAY SUMMARY  
(ENGLISH/METRIC)**

CONSTRUCTION  
02/01

Project Name _____	Page _____ of _____
FIN Project No. _____	Pier No. _____
Contractor _____	Shaft No. _____
Inspected By _____ Date _____	Station _____
Approved By _____ Date _____	Offset _____

Type of Construction	Casing _____	Note _____
_____ Dry _____ Wet/Drill mud only	_____ Removed	
_____ Wet/Casing only _____ Wet/Drill mud & casing	_____ Permanent	

Notes \_\_\_\_\_

\_\_\_\_\_

\_\_\_\_\_

Construction Activity	Time	Date mm/dd/yy	Shaft Details		
			Plan	Built	
Set Casing	_____	_____	Shaft Top El.	ST	_____
Begin Excavation (Below Casing)	_____	_____	Casing Top El.	CT	_____
Beg. Soil Excav.	_____	_____	Water Table El.	WT	_____
Fin. Soil Excav.	_____	_____	Perm Casing ID	CID	_____
Beg. Rock Excav.	_____	_____	Perm. Casing OD	COD	_____
Fin Rock Excav.	_____	_____	Ground Surf. El.	GS	_____
Rock Core Taken	_____	_____	Casing Bot. El.	CB	_____
Overream	_____	_____	Shaft Diameter	SD	_____
Init. Inspection	_____	_____	Top of Rock El.	RT	_____
Fin. Inspection	_____	_____	Rk. Core Top El.	RCT	_____
Beg. Concrete Pl.	_____	_____	Rock Core Dia.	RCD	_____
Fin. Concrete Pl.	_____	_____	Rock Socket Dia.	RD	_____
Constr. Complete	_____	_____	Overream Top El.	OT	_____
			Overream Bot. El.	OB	_____
			Shaft Bottom El.	SB	_____
			Rk. Core Bot. El.	RCB	_____

	Length Provided (ft)/(m)	Length Adjustment (ft)/(m)	Pay Length (ft)/(m)	Notes
Permanent Casing	CT-CB	_____	_____	_____
Soil Excavation	GS-RT	_____	_____	_____
Rock Excavation	RT-SB	_____	_____	_____
Extra Depth Excav. SBplan - SBbuilt		_____	_____	_____
Overream length	OT-OB	_____	_____	_____
Drilled Shaft Length	ST-SB	_____	_____	_____
Rock Core Length	RCT-RCB	_____	_____	_____
		_____	_____	_____
		_____	_____	_____

**Adjustments**

Soil Excavation = (GS-RT) x (SDplan-SDbuilt) = ( - ) = \_\_\_\_\_  
 SD (built<plan)                      SDplan

Rock Excavation = (RT-SB) x (RDplan-RDbuilt) = ( - ) = \_\_\_\_\_  
 RD (built<plan)                      RDplan

Drilled Shaft Length =  $\nabla$ Excavation Adjustments + Any Other Adjustments

DRILLED SHAFT SOIL EXCAVATION LOG

Project Name \_\_\_\_\_ Pier No. ABUT-1  
 Project No. 85180-3522 Shaft No. 3  
 Contractor \_\_\_\_\_ Station 32+60.00  
 Inspected By \_\_\_\_\_ Date 3-28-00 Offset (m) 7.26 RIGHT  
 Approved By \_\_\_\_\_ Date \_\_\_\_\_

Casing Information					Soil Bucket Dia. (mm)	
ID (mm)	OD (mm)	Top Elev. (m)	Length (m)	Bot. Elev. (m)	Mud Line/Ground Elev.	Water Table Elev. (m)
<u>1200</u>	<u>1220</u>	<u>+1.30</u>	<u>8.40</u>	<u>-9.10</u>	<u>+2.40</u>	
		<u>19.70</u>	<u>18.99</u>	<u>-19.29</u>	<u>+9.00</u>	
					Reference Elev. (m)	
					Drilling Mud	<u>N/A</u>

Notes 2.39 OFFSET

Date	Elevation (m)	Time	Soil Description and Notes
<u>3-28-00</u>		<u>2:38</u> in	
	<u>+1.30</u>	<u>2:40</u> out	<u>TAN Limestone FILL</u>
		<u>2:41</u> in	
	<u>+0.62</u>	<u>2:43</u> out	<u>SAME</u>
		<u>2:44</u> in	
	<u>-0.20</u>	<u>2:45</u> out	<u>SAME</u>
		<u>2:46</u> in	
	<u>-0.53</u>	<u>2:48</u> out	<u>TAN + GRAY SANDY Limestone FILL</u>
		<u>2:49</u> in	
	<u>-1.23</u>	<u>2:51</u> out	<u>BLACK SILTY SAND (ORGANIC)</u>
		<u>2:52</u> in	
	<u>-1.94</u>	<u>2:54</u> out	<u>SAME</u>
		<u>2:55</u> in	
	<u>-2.60</u>	<u>2:57</u> out	<u>GRAY FINE SAND + SHELL</u>
		<u>2:58</u> in	
	<u>-3.16</u>	<u>3:00</u> out	<u>GRAY + TAN FINE SAND + SHELL</u>
		<u>3:02</u> in	
	<u>-4.40</u>	<u>3:09</u> out	<u>TAN SAND WITH CEMENTED LAYERS</u>
<u>3-30-00</u>		<u>4:47</u> in	
	<u>-6.10</u>	<u>9:50</u> out	<u>GRAY FINE SAND</u>
		<u>9:51</u> in	
	<u>-6.68</u>	<u>9:55</u> out	<u>TAN + GRAY FINE SAND + SHELL</u>
		<u>9:57</u> in	
	<u>-7.59</u>	<u>10:01</u> out	<u>GRAY</u>

Approved \_\_\_\_\_  
 Soils Engineer

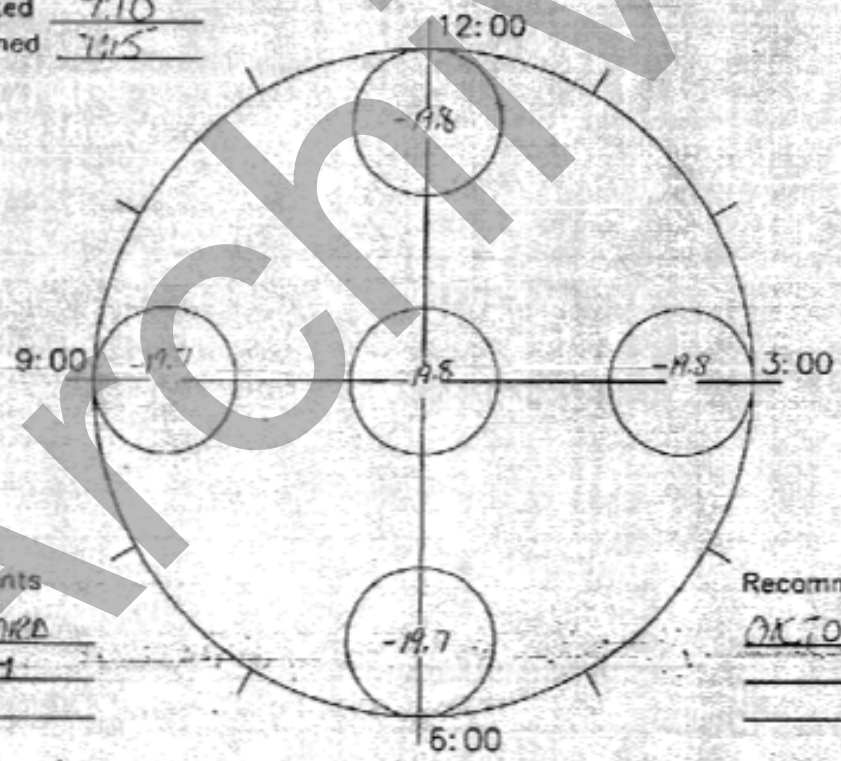
### DRILLED SHAFT INSPECTION

Project Name _____	Pier No. <u>ABUT-1</u>
Project No. <u>86180-3522</u>	Shaft No. <u>3</u>
Contractor _____	Station <u>32160.00</u>
Inspected By _____	Offset (m) <u>7.26 RT</u>
Approved By _____	Date <u>4-4-00</u>

Type of Drilling Fluid <u>WATER</u>	Shaft Plumbness Check <input checked="" type="checkbox"/>
Drilling Fluid Check <u>1270 KG/M<sup>3</sup></u>	Rebar Cage: _____
Bottom Clean-out Method <u>BAILER</u>	Proper - Vert. Bars <input checked="" type="checkbox"/>
Time/Date Final Clean-out <u>6:40 AM 4-4-00</u>	Proper - Horiz. Bars <input checked="" type="checkbox"/>
Shaft Bottom Elev. (m) <u>-19.8</u>	Side Stand-offs <input checked="" type="checkbox"/>
Est. Shaft Bottom Dia. (mm) <u>1220</u>	Bottom Stand-offs <input checked="" type="checkbox"/>
	Epoxy Condition <u>N/A</u>
	Ties and Connections <input checked="" type="checkbox"/>

Inspected by  Visual (S.I.O.)      Job North at 12:00  
 Sounding  
 Other

Time Started 7:10  
 Time Finished 7:15



Comments  
GOOD HARD  
BOTTOM

Recommendations  
OK TO FOUR

Results:  Satisfactory      Given to \_\_\_\_\_       Verbal /  Written  
 Unsatisfactory      By \_\_\_\_\_      Time 7:20 AM Date 4-4-00

Approved \_\_\_\_\_  
 Soils Engineer



### DRILLED SHAFT LOG

Project Name: [REDACTED] Pier No. ABUT-1  
 Project No. 86180-3522 Shaft No. 3  
 Contractor: [REDACTED] Station 32+60.00  
 Inspected By: [REDACTED] Date 4-4-00 Offset (m) 7.26 RT  
 Approved By: \_\_\_\_\_ Date \_\_\_\_\_

Date Cased 3-28-00 Casing Type STEEL  
 Date Opened 3-28-00 Casing Dimension: OD (mm)/220 Length (m) 23.70  
 Date Poured 4-4-00 Bottom of Casing Elevation (m) -19.31  
 Diameter of Rock Socket (mm) 1220  
 Diameter of Overburden Shaft (mm) 1220  
 Mudline/Ground Surface Elevation (m) +2.60  
 Overburden Shaft Length (m) 18.60  
 Rock Socket Length (m) 3.8  
 Cutoff Elevation (m) +2.97  
 Tip Elevation (m) -19.8  
 Constructed Shaft Length (m) 22.80  
 Testing/Other \_\_\_\_\_



Volume of Concrete: Theoretical (m<sup>3</sup>) 26.69  
 A/T Actual (m<sup>3</sup>) 30.96  
 Reinforcement Cage Installed: Type S. 35R#4  
 Duration of Pour (min) 273

- Legend**
- TOC Top of Casing
  - TOG Top of Ground
  - TOS Top of Shaft
  - TOR Top of Rock
  - BOC Bottom of Casing
  - BOS Bottom of Shaft

∇ Water Level

Inspected by: [REDACTED]  
 Approved: \_\_\_\_\_  
 Soils Engineer

Distribution:  
 Original - \_\_\_\_\_  
 Copy - [REDACTED]  
 Copy - \_\_\_\_\_

**APPENDIX G**

**STANDARD CIDH PILE  
ANOMALY MITIGATION PLAN**

Archived

Archived

This page is intentional left blank.



## **STANDARD MITIGATION PLAN "A" - BASIC REPAIR**

Basic repair involves visual inspection of concrete followed by mechanical removal and replacement of unacceptable concrete from anomalies accessed from the ground surface or by excavation. Mechanical removal is performed using a chipping gun or similar means under the observation and direction of the inspector.

### **A. Excavation**

1. Excavate alongside of the CIDH pile in the vicinity of the designated inspection tube(s) to a depth of one foot below the identified anomaly to provide access. Shoring plans, confined space plans, and provisions for replacement of earthen materials disturbed by excavation shall be submitted as appropriate.

### **B. Removal of Deleterious Material**

1. After excavation and exposure of the anomaly, all visually deleterious or questionable material will be removed. Mechanical removal will "chase" all inclusions or compromised concrete until competent concrete is encountered.
2. If the surface of the CIDH pile shows apparently competent concrete, the identified anomaly will be hammer tested or hand-chipped one inch to demonstrate that the surface manifestation is consistent with concrete below the pile surface.

### **C. Additional Inspection**

1. At contractor's option, a minimum 3-inch diameter core sample shall be obtained from the anomalous zone if required for additional visual inspection and/or strength testing. The core shall extend to the center of the anomalous zone or as approved by Caltrans. Strength testing shall be performed in accordance with Caltrans standard testing procedures.
2. If visual inspection or the results of compressive strength testing indicate that the concrete is not acceptable, the unacceptable concrete shall be mechanically removed to the extent determined by the inspector.

D. Verification of Results by Engineer

1. After the Contractor has removed all material that is visibly compromised or questionable, the Engineer will visually and physically inspect the effectiveness of the removal operation. If the concrete is deemed acceptable, the removal will be terminated and approved. If additional questionable material is identified, the Contractor shall remove this material and request that the Engineer reinspect.

E. Replacement

1. After removal of unacceptable concrete and questionable material, forms shall be constructed as necessary, and the specified concrete mix shall be placed in the repair area.
2. After the concrete has cured, forms shall be removed.

F. Restoration of Earthen Materials

1. Earthen materials shall be replaced as approved by Caltrans. Where not otherwise designated, earthen materials shall be replaced using the excavated soil and compacted to a relative density that approximates the undisturbed, in-situ density of adjacent earthen materials. Two-sack sand slurry may be used if the Engineer of Record indicates that this will not adversely affect the lateral stiffness of the pile.

G. Reporting

1. Upon completion of the mitigation procedure, a mitigation report shall be submitted stating what repair work was performed and whether the repair work conformed with the mitigation plan. Any deviations from the mitigation plan must be stated in the report.

## **STANDARD MITIGATION PLAN "B" - GROUTING REPAIR**

### **A. Inspection Tube Removal and High-Pressure Washing**

1. The PVC inspection tube shall be cut with high pressure water for the entire elevation range of the anomaly, extending from two feet below the anomaly to two feet above the anomaly. The anomaly shall be pressure washed with the high pressure water directed laterally against the side of the hole and rotated as it is slowly withdrawn. Water jetting shall begin from the lowest anomalous region and proceed upward. Only one anomaly shall be washed and grouted at a time, except where approved in writing by the Engineer.
2. The Contractor shall make provisions to ensure that the required cutting pressure is achieved at the anomaly depth and that the PVC tube is entirely removed at the repair location. Water pressures typically range from 9,000 to 15,000 psi at a rate of 10 to 15 gpm. Several hundred psi may be lost in the line as a result of pump and line configuration. Lower pressures may be used at contractor's discretion once PVC inspection tube is removed.
3. Washing will continue until no further solids are observed emanating from the inspection tube and the return flush water is clear, except in the case of erosion of native material, as noted in paragraph 6 below.
4. The Contractor shall monitor the solids content in the wash return water by periodically straining solids out of the effluent.
5. The Contractor shall keep a log of unanticipated communication between holes, water color, type of solids, and estimated solids content.
6. The pressure washing procedure shall be monitored to reduce the chance of disturbance of the formation around the pile while attempting to remove loose sediment and contaminated concrete. Washing shall be discontinued if evidence of significant erosion of native material is observed.

### **B. Flushing**

1. Flushing (high-volume, low-pressure washing) shall be performed if there is significant communication between inspection tubes. The

purpose of flushing is to remove loose material after pressure washing and prior to grouting or down-hole camera observation.

2. Water shall be pumped into an inspection tube and be allowed to return from another tube or around a tremie tube inserted into a single inspection tube. Air, water or alternating injections of air and water may be used for flushing.
3. Flushing will continue until no significant solids are observed emanating from the inspection tube and the return flush water is clear, except in the case of erosion of native material, as noted in paragraph 6 below.
4. The Contractor shall monitor the solids content in the wash return water by periodically straining solids out of the effluent.
5. The Contractor shall keep a log of unanticipated communication between holes, water color, type of solids, and estimated solids content.
6. The flushing procedure shall be monitored to reduce the chance of disturbance of the formation around the pile while attempting to remove loose sediment and contaminated concrete. Flushing shall be discontinued if evidence of significant erosion of native material is observed.

C. Water Flow Test

1. A packer shall be seated in the tube below the top of the concrete, or the inspection tube shall be sealed by other means, as deemed appropriate by the Contractor. The Contractor shall be solely responsible for health and safety.
2. Valves on all ports shall be open.
3. Water shall be injected through the grout port.
4. The Contractor shall record pressure, injection rate, signs of communication to other ports, signs of communication to the ground surface, amount of water used, color of return water, and time.
5. After all communicating ports are closed, the water flow testing shall be continued to determine whether there is significant permittivity (flow into

the formation). A water injection rate into the inspection tube of less than 1 gpm at a pressure of 10 to 20 psi (in addition to the existing hydrostatic pressure in the inspection tube) is typically considered insufficient permissivity for permeation grouting. In the case of insufficient permissivity, replacement grouting is to be utilized, unless other factors provide compelling reasons not to utilize replacement grouting.

6. If permeation grouting is to be performed, the water injection rate will be used to help determine an appropriate water:cement ratio for the starting grout mix. The starting grout mix will be determined based on the attached Chart 1. For example, a take of 20 gpm at 10 to 20 psi indicates that a thin starting mix (such as mix #1 presented in the attached Grout Mix Table) is preferred. Take of 10 gpm at 10 to 20 psi indicates that a starting mix such as No. 2 or 3 is preferred. Take lower than 10 gpm indicates that lower water:cement ratios are appropriate for the starting mix, as suggested by Chart 1 and determined in the field by a qualified grouting contractor.
7. If the Contractor suspects insignificant water flow and plans to mitigate by replacement grouting, the falling head test, as described below, may be used as an alternative to the water flow test procedure described in this section. The purpose of the falling head test is to verify that flow is insignificant prior to performing replacement grouting. If the results of the falling head test indicate that flow into the surrounding formation exists, the water flow test described in this section will be performed.

#### D. Falling Head Test

1. If groundwater is within 25 feet (7.6 m) of the top of the inspection tube, the tube shall be extended a minimum of 25 feet above the groundwater table.
2. The inspection tubes shall be filled to the top with water.
3. If communication exists between tubes, the falling head test shall be performed concurrently in communicating tubes.
4. Flow into the formation will be evidenced by a drop in water level inside the inspection tube. If flow into the formation is demonstrated, a water flow test is to be performed. Replacement grouting is to be performed if flow into the formation is not evident.

E. Down-Hole Camera Observation

1. Down-hole camera observation shall be performed, if required, after high-pressure washing and flushing. The purpose of down-hole camera observation is to verify that the PVC inspection tubes were completely removed from the anomalous zone, to verify that deleterious materials have been adequately removed, and to provide additional information regarding the character and extent of the anomaly.
2. Dry conditions are typically preferable for camera observation. If the flow of groundwater into the inspection tubes is not rapid, i.e., 2 to 3 gpm at 10 to 20 psi, the inspection tubes shall be cleared by air injection after water flow testing and prior to down-hole camera observation or replacement grouting. Camera observation under water may be performed if visibility is acceptable. If camera observation is to be performed under water, flushing will be performed to remove suspended materials from the water within the inspection tubes and scoured anomaly area if visibility is poor.

F. Permeation Grouting

1. The permeation grouting procedures presented below are intended to serve as the standard procedures for grouting. On occasion, it may be necessary to modify the procedures contained herein in response to field conditions to achieve the desired result. The grouting foreman shall have sufficient permeation grouting experience to provide that determination. Any alteration of the standard plan should be clearly identified in the submitted post-mitigation report.
  - a. The grouting contractor must evaluate water pressure and rate of take based on water flow test results, as discussed above. If the water flow test indicates that permeation grouting should not be utilized, do not proceed.
  - b. Permeation grouting requires that sufficient confining pressure be present to conduct grouting operations without grout returning to the surface. Permeation grouting should not be selected for pile mitigation less than 10 feet from the ground (or working) surface.
  - c. The intent of grouting for CIDH piles is to address the structural, geotechnical, and corrosion concerns identified for that foundation element. To that end, grouting purposes to promote the maximum

- rate of solids injection, as opposed to the maximum rate of grout injection.
- d. The Contractor shall be solely responsible for health and safety.
2. Nittetsu Superfine cement shall be used for permeation grouting. Grout mix ratios and mix designations are presented in Table 1.
    - a. The ratios shown in the attached Table 1 are based on Nittetsu Superfine cement packaged in 22 kg bags and having a specific gravity of 2.75. A batch of permeation grout is typically 33 gallons.
    - b. Thin grout mixes (such as mixes #1 through #6) are not appropriate for structural mitigation if injected into a void, as they are unstable and will generally not achieve the required design strength.
    - c. Due to the small grain size of Nittetsu Superfine cement, the mix becomes thixotropic at a water:cement (W:C) ratio of 0.8:1. The superplasticizer also acts as a retarder. Use of superplasticizer will be determined by the grouting Contractor, as required for favorable flow characteristics and to reduce the chance of grouting equipment damage. The Contractor is solely responsible for performing the grouting procedure in such a manner that equipment does not become plugged or otherwise damaged. Use of superplasticizer shall be in accordance with the microfine cement manufacturer's recommendations.
    - d. The actual volume of the voids is not known, and grout solids are likely to enter the surrounding formation. The Contractor shall secure an adequate supply of cement and water for the repairs. The compressive strength of materials permeated with microfine cement solids depends not only on the strength of the grout, but also on the strength of the solid matrix into which the grout is injected. Strength generation is generally slow due to the superplasticizer. Actual strengths will depend upon grout solids permeation and matrix characteristics.
  3. The starting grout mix will be determined by the grouting contractor based on the results of water flow testing. The starting grout mix will be in accordance with Chart 1.
  4. Grout shall initially be placed by tremie until it returns from the top of the injection port at a consistency similar to the injected grout. If starting

- with mix #1 or #2 and significant communication and bleed off is anticipated, initial tremie placement is not necessary.
5. Inflate packers to seal tube. Where multiple tubes are being grouted in the same process, all tubes must be grouted simultaneously by means of a common manifold. Alternate means that accomplish the same intent may be utilized where approved by the Engineer.
  6. Batches of grout shall be injected under pressure, beginning with the starting grout mix.
  7. At the completion of each batch of grout, the Grouting Contractor shall evaluate the grout take and pressure to determine the thickness of the next batch of grout to be injected. The grout mix will be increased as pressure increases in general accordance with Chart 2. If the starting mix is thicker than the mix indicated by Chart 2, continue to use the starting mix.
    - a. The grout mix number is increased as the grouting pressure increases, to reduce the chance of premature refusal during a void filling application and to progressively thicken mix to structural mixes as pores within the grouted material become filled.
  8. Inject next batch of grout and repeat Step 7 until refusal is reached. For refusal, see Step 12.
  9. If the formation does not appear to be plugging (If the pressure does not increase or flow rate decrease after injection under pressure of three full batches), the grouting contractor may elect to thicken the grout by one mix number.
    - a. If mix #7 or #8 does not plug the formation quickly, an ordinary Portland cement grout may be used. The replacement-type grout mix shall consist of Type II Portland cement mixed at the ratio of one 94-pound sack of Type II cement per five gallons of water.
    - b. If plugging does not seem to be occurring with Mix #7, Mix #8 or Portland cement grout, the contractor may shut off the pump for intervals of 2 to 10 minutes to assist grouting process.
  10. If grout returns to the surface at any time, note the location and estimate the volume of grout seepage. Also estimate the thickness of the return



grout. If the amount of grout return approximates the injection rate, shut off the pump for intervals of 2 to 5 minutes. Use shorter intervals initially or if using thick mixes. In the case of immediate, direct communication, attempt to plug the leak with a half batch of mix #7 followed by a half batch of mix #8.

- a. If grout returns to the surface and interruptions in grouting do not control the leak, the contractor may thicken the grout to the thickest mix possible and discontinue grouting when the thick grout reaches the surface. Identify this condition in the post-mitigation report.
11. The contractor shall consider known difficulties associated with thick mixes and plan accordingly.
    - a. When using thicker mixes such as #7 or #8, check the pressure frequently and be prepared to dilute the mix if signs of plugging in the hoses or fittings are noted (plugging is common with this mix). If the mix is diluted to address plugging of the equipment, do not inject the thinned mix into the pile.
    - b. When pumping mix #8, look for signs of hydro-fracturing and test for refusal frequently. (Mix #8 has a very high viscosity and will permeate only a few inches in most geomaterials.)
    - c. Mix #8 is often mixed in half-batches, especially for small grouting operations.
  12. Refusal is defined as zero take at 150 psi. Grouting pressures shall be held for five minutes prior to release.
    - a. Refusal must be achieved with a sufficient quantity of structural grout mix (#7 or #8) for the grouting operation to be considered complete. If refusal is achieved during permeation grouting prior to injection of sufficient quantity of a structural grout mix, mix #8 will be tremied to the bottom of the anomaly location to completely displace thinner mixes.
      - i. For the purposes of Step 12a, "sufficient quantity" is considered to be greater than or equal to the estimated volume of the cavity developed by high-pressure washing, plus the volume of the tube/grouting port, plus the volume contained in the hoses above the anomaly to the grouting batching plant.

- ii. Filling of the anomalous zone by tremie will be confirmed by consistent return of mix #8 at the top of the tube.
  - iii. Upon filling, the grout is to be pressurized to approximately 150 psi and held at that pressure for a minimum of five minutes.
  - iv. A sudden pressure drop at high pressures may be a sign that hydro-fracture of the formation has occurred during refusal. Indications of hydro-fracture are to be identified in the post-mitigation report.
13. All Equipment utilized by the Contractor shall be used according to manufacturer's recommendations in a safe manner that will result in the desired finished product.
- a. The grout mixing and pumping unit shall be a colloidal mixer with a progressive cavity injection pump (Chem Grout colloidal mixer or approved equivalent).
  - b. Pressure gauges shall be bourdon tubes with 4% accuracy. Gauge protectors shall be used and the gauges shall be replaced on a three- to four-shift cycle. The pressure range of the gauge shall be selected to allow for the anticipated grout pressure to fall in the middle third of the pressure range.

#### G. Replacement Grouting

1. The inspection tube shall be completely cleared of water. Extra care is required to assure all water is removed, as residual water will block the grout from completely filling the cavity. Begin tremie placement in all tubes associated with the anomaly as soon as the water is cleared.
2. The anomaly and inspection tube shall be filled with grout by tremie from the bottom of the voided inspection tube. The tremie shall be maintained below the level of the grout during placement. The tremie shall be extracted when the inspection tube is completely filled with grout.
3. After the inspection tube is completely filled with grout, the grout shall be pressurized through a port installed in the inspection tube to a minimum of 150 psi and held at that pressure for a minimum of five minutes. The Contractor shall be solely responsible for health and safety.

4. Grout shall conform to Section 50-1.09 of the Standard Specifications and shall consist of Type II cement mixed at the ratio of one sack of cement per five gallons of water. Using a 94-pound sack of cement, the water:cement ratio would be approximately 0.44. The Contractor shall verify that the grout strength corresponds to the required design strength.
5. The Contractor shall have an adequate supply of cement and water for the repairs.

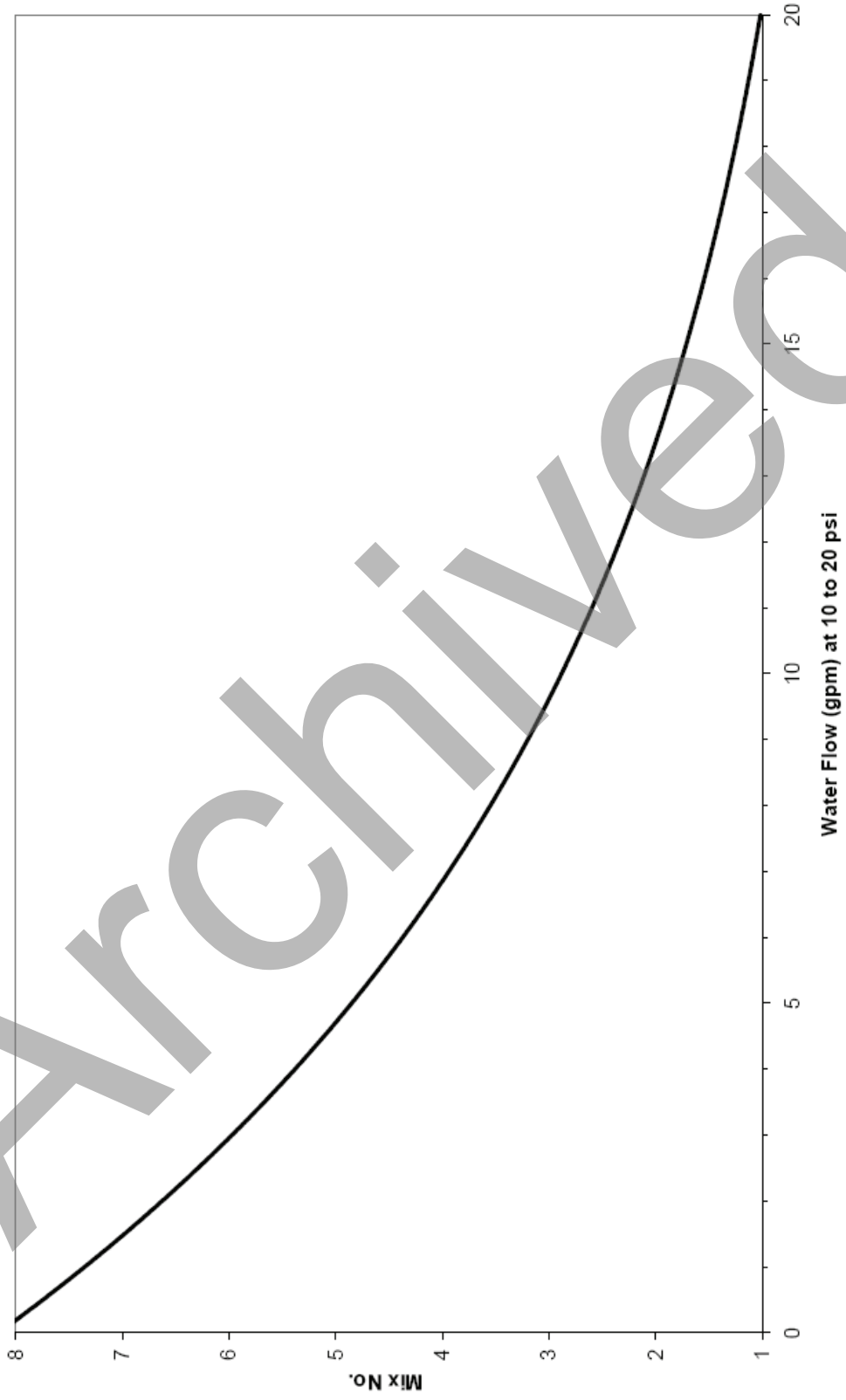
#### H. Reporting

1. Upon completion of the mitigation procedure, a mitigation report shall be submitted to Caltrans stating what repair work was performed and whether the repair work conformed with the mitigation plan. Any deviations from the mitigation plan shall be stated in the report, including an explanation of the compelling reason that prompted the modification.
2. The mitigation report shall contain a summary of the repair procedures, which typically includes a summary of observations made during the repair, comparison of the anticipated anomaly volumes with the actual grout quantities used, and the results of testing if performed.

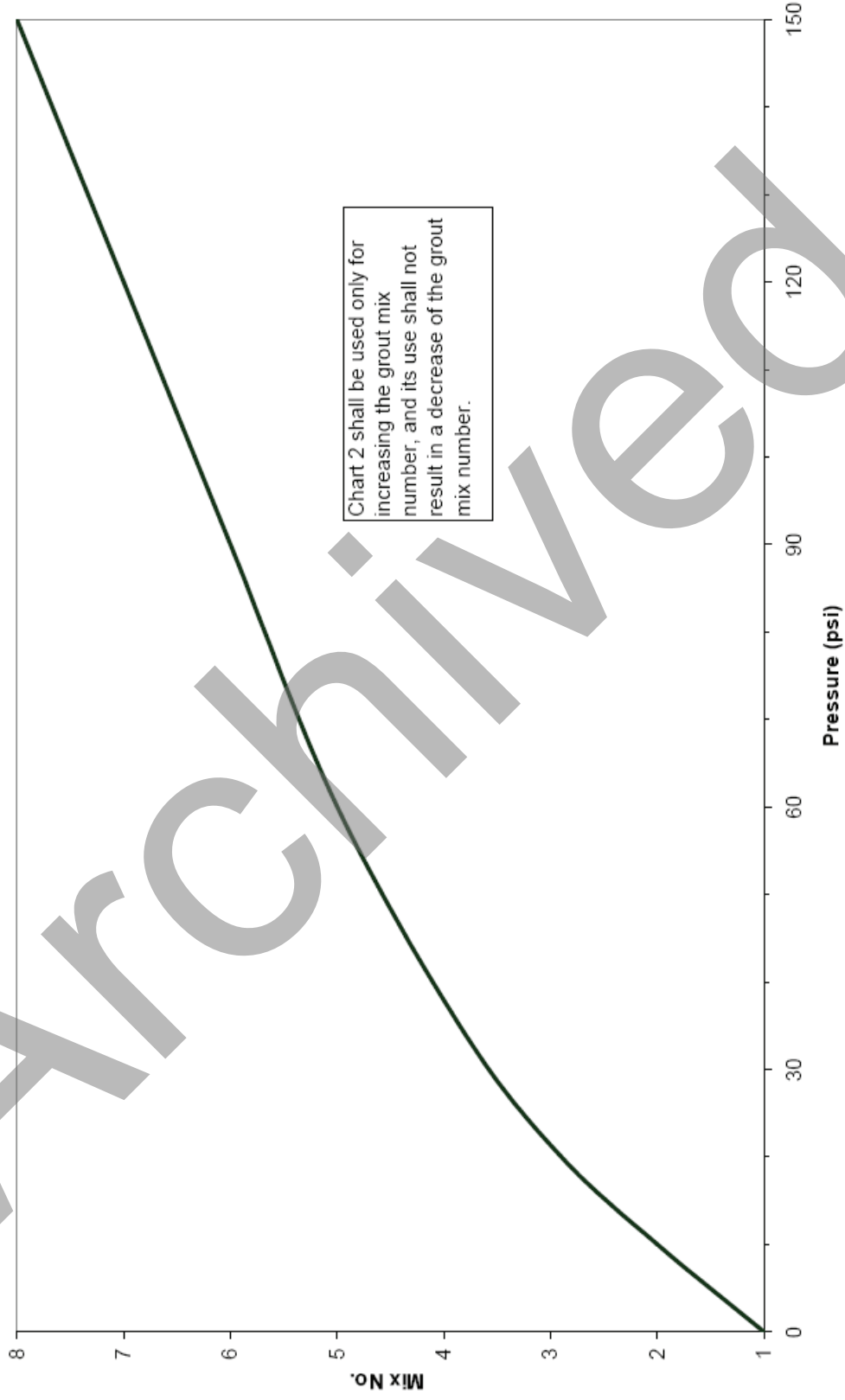
<b>Table 1 – Grout Mix Table</b>						
Mix	Cement (bags)*	Water (gallon)	Weight (lbs)	Volume (gallons)	Density (lbs/gal)	W/C
1	1.0	33.0	319.2	34.9	9.1	6.3
2	2.0	33.0	363.2	36.8	9.9	3.1
3	3.0	33.0	407.2	38.8	10.5	2.1
4	4.0	33.0	451.2	40.7	11.1	1.6
5	5.0	33.0	495.2	42.6	11.6	1.3
6	6.0	33.0	539.2	44.2	12.2	1.0
7	7.0	33.0	583.2	46.0	12.7	0.9
8	8.0	33.0	627.2	48.0	13.1	0.8

Note: \* Based on 22 kg per bag.

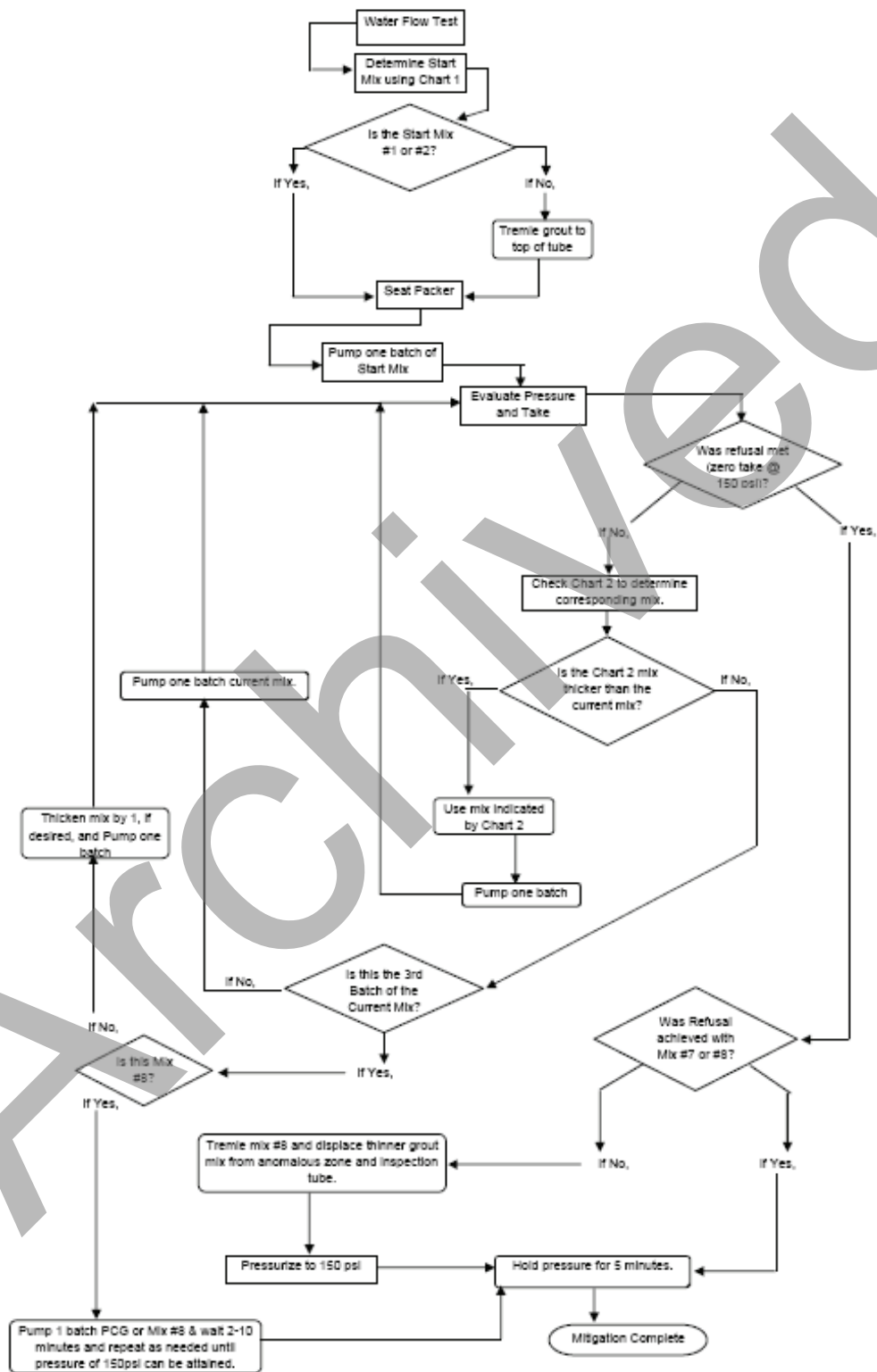
Chart 1 - Starting Mix for Permeation Grouting



**Chart 2 - Relationship Between Mix Number and Pressure for Permeation Grouting**



Permeation Grouting Procedure for CIDH Pile Repair



<b>Example - Summary of Anomalies Detected During Acceptance Testing</b> Standard Mitigation Plan								
Bent No.	Approximate Depth Interval of Anomaly <sup>1</sup> (measured in feet from top of pile)	Approximate Depth of Bottom of CMP Liner (feet)	Inspection Tubes	Apparent Length of Anomaly (ft)	Estimated Maximum Percent of Cross Sectional Area <sup>1,2</sup>	Estimated Maximum Volume of Anomaly <sup>2,3</sup> (ft <sup>3</sup> )	Proposed Repair Interval (measured in feet from top of pile)	Proposed Repair Method
3	21-23	31	1-5, 8-10, 12, 13	2	71	188	18-25	permeation / replacement grout
4	18.5-20.5	35	1-7, 9-14	2	93	247	15.5-22.5	permeation / replacement grout
5	28-29.5	40	1, 4-7, 10-14	1.5	71	141	25-31.5	permeation / replacement grout
5	43-44	40	1, 4	1	14	19	n/a	none

Notes: 1 Based on acceptance test report.

2 Maximum percent of cross sectional area was estimated based on GGL results by assuming that each of the 14 inspection tubes accounted for 1/14 of the total cross sectional area. Based on CSL results, the anomalies are likely to be located primarily on the exterior of the rebar cage. Thus, actual percent of cross sectional area affected and anomaly volume may be significantly less than the estimated maximum area and volume.

3 Based on 13-foot nominal pile diameter.

ADSC West Coast Chapter





SUPER FINE GROUT MIX PROPORTION

◆ **Super Fine Grout**  
(1000 L)

Water:SF ratio	Water (L)	DA (kg)	SF (kg)	Compressive Strength (MPa)	
				7 days	28 days
0.6:1	634	10.7	1,071	19.5	40.2
0.8:1	699	8.8	882	15.2	31.7
1:1	750	7.5	744	9.8	23.6

SF : Super Fine (Nittetsu Cement Co.,Ltd )

DA (Dispersion Admixture) : Mighty 150R ( Kao Corporation )

## **APPENDIX H**

# **ALTERNATIVE MODELS FOR ANALYSIS OF LATERAL LOADING**

Archived

Archived

This page is intentional left blank.

## APPENDIX H

### ALTERNATIVE MODELS FOR ANALYSIS OF LATERAL LOADING

#### INTRODUCTION

This Appendix is provided to include an overview of several alternative models reported in the literature for analysis of lateral loading. Alternative models include those based on elastic continuum, boundary element, and finite element models. A brief overview of these models follows, with references for further investigation.

#### H.1 Elastic Continuum and Boundary Element Models

The elastic continuum approach for laterally loaded deep foundations was developed by Poulos (1971), initially for analysis of a single pile under lateral and moment loading at the pile head. The numerical solution is based on the boundary element method with the pile modeled as a thin elastic strip and the soil modeled as a homogeneous, isotropic elastic material. This approach was used to approximate socketed piles by Poulos (1972) by considering two boundary conditions at the tip of the pile: (1) the pile is completely fixed against rotation and displacement at the tip (rock surface), and (2) the pile is free to rotate but fixed against translation (pinned) at the tip. The fixed pile tip condition was intended to model a socketed deep foundation while the pinned tip was intended to model a pile bearing on, but not embedded into, rock. While these tip conditions do not adequately model the behavior of many rock socketed shafts, the analyses served to demonstrate some important aspects of socketed deep foundations. For relatively stiff foundations, which applies to many drilled shafts, considerable reduction in displacement at the pile head can be achieved by socketing, especially if the effect of the socket is to approximate a "fixed" condition at the soil/rock interface.

The elastic continuum approach was further developed by Randolph (1981) through use of the finite element method. Solutions presented by Randolph cover a wide range of conditions for flexible piles and the results are presented in the form of charts as well as convenient closed-form solutions for a limited range of parameters. The solutions do not adequately cover the full range of parameters applicable to drilled shafts used in practice. Extension of this approach by Carter and Kulhawy (1992) to rigid shafts and shafts of intermediate flexibility, has led to analytical tools for drilled shafts in rock based on the continuum approach.

Sun (1994) applied elastic continuum theory to deep foundations using variational calculus to obtain the governing differential equations of the soil and pile system, based on the Vlasov model for a beam on elastic foundation. This approach was extended to rock socketed shafts by Zhang et al (2000).

The continuum models developed by Carter and Kulhawy and by Zhang et al are described below.

##### H.1.1 Carter and Kulhawy Model for an Elastic Shaft Embedded in an Elastic Rock Mass

Carter and Kulhawy (1988, 1992) studied the behavior of flexible and rigid shafts socketed into rock and subjected to lateral loads and moments. Solutions for the load-displacement relations were first generated using finite element analyses. The finite element analyses followed the approach of Randolph (1981) for flexible piles under lateral loading. Based on the FEM solutions, approximate closed-form equations

were developed to describe the response for a range of rock socket parameters typically encountered in practice. The results provide a first-order approximation of horizontal groundline displacements and rotations and can incorporate an overlying soil layer. The method is summarized as follows.

Initially, consider the case where the top of the shaft corresponds to the top of the rock layer (Figure H-1). The shaft is idealized as a cylindrical elastic inclusion with an effective Young's modulus ( $E_e$ ), Poisson's ratio ( $\nu_c$ ), depth ( $D$ ), and diameter ( $B$ ), subjected to a known lateral force ( $H$ ) and an overturning moment ( $M$ ). For a reinforced concrete shaft having an actual flexural rigidity equal to  $(EI)_c$ , the effective Young's modulus is given by:

$$E_e = \frac{(EI)_c}{\frac{\pi B^4}{64}} \quad \text{H-1}$$

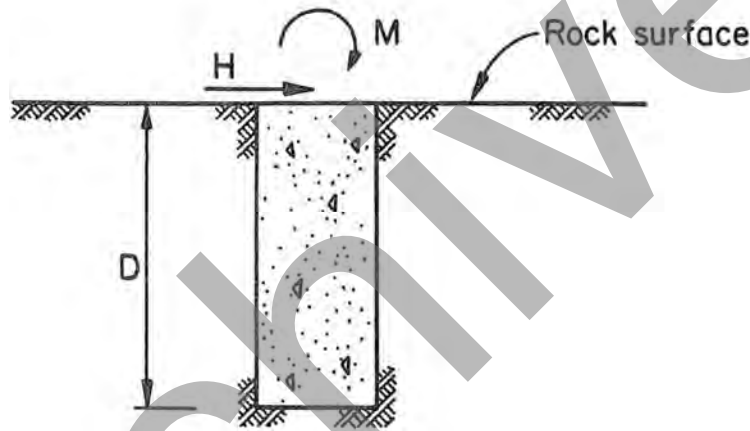


Figure H-1 Lateral Loading of a Rock-Socketed Shaft (Carter and Kulhawy 1992)

It is assumed that the elastic shaft is embedded in a homogeneous, isotropic elastic rock mass, with properties  $E_r$  and  $\nu_r$ . Effects of variations in the Poisson's ratio of the rock mass ( $\nu_r$ ), are represented approximately by an equivalent shear modulus of the rock mass ( $G^*$ ), defined as:

$$G^* = G_r \left( 1 + \frac{3\nu_r}{4} \right) \quad \text{H-2}$$

in which  $G_r$  = shear modulus of the elastic rock mass. For an isotropic rock mass, the shear modulus is related to  $E_r$  and  $\nu_r$  by:

$$G_r = \frac{E_r}{2(1 + \nu_r)} \quad \text{H-3}$$

Based on a parametric study using finite element analysis, it was found that closed-form expressions could be obtained to provide reasonably accurate predictions of horizontal displacement ( $u$ ) and rotation ( $\theta$ ) at the head of the shaft, for two limiting cases. The two cases correspond to flexible shafts and rigid shafts. The criterion for a flexible shaft is:

$$\frac{D}{B} \geq \left( \frac{E_c}{G^*} \right)^{2/7} \quad \text{H-4}$$

For shafts satisfying Equation H-4, the response depends only on the modulus ratio ( $E_c/G^*$ ) and Poisson's ratio of the rock mass ( $\nu_r$ ) and is effectively independent of ( $D/B$ ). The following closed-form expressions, suggested by Randolph (1981), provide accurate approximations for the deformations of flexible shafts:

$$u = 0.50 \left( \frac{H}{G^* B} \right) \left( \frac{E_c}{G^*} \right)^{-1/7} + 1.08 \left( \frac{M}{G^* B^2} \right) \left( \frac{E_c}{G^*} \right)^{-3/7} \quad \text{H-5}$$

$$\theta = 1.08 \left( \frac{H}{G^* B^2} \right) \left( \frac{E_c}{G^*} \right)^{-3/7} + 6.40 \left( \frac{M}{G^* B^3} \right) \left( \frac{E_c}{G^*} \right)^{-5/7} \quad \text{H-6}$$

Carter and Kulhawy (1992) report that the accuracy of the above equations is verified for the following ranges of parameters:  $1 \leq E_c/E_r \leq 10^6$  and  $D/B \geq 1$ .

The criterion for a rigid shaft is:

$$\frac{D}{B} \leq 0.05 \left( \frac{E_c}{G^*} \right)^{1/2} \quad \text{H-7}$$

And

$$\frac{E_c/G^*}{(B/2D)^2} \geq 100 \quad \text{H-8}$$

When Equation H-7 and H-8 are satisfied, the displacements of the shaft will be independent of the modulus ratio ( $E_c/E_r$ ) and will depend only on the slenderness ratio ( $D/B$ ) and Poisson's ratio of the rock mass ( $\nu_r$ ). The following closed-form expressions give reasonably accurate displacements for rigid shafts:

$$u = 0.4 \left( \frac{H}{G^* B} \right) \left( \frac{2D}{B} \right)^{-1/3} + 0.3 \left( \frac{M}{G^* B^2} \right) \left( \frac{2D}{B} \right)^{-7/8} \quad \text{H-9}$$

$$\theta = 0.3 \left( \frac{H}{G^* B^2} \right) \left( \frac{2D}{B} \right)^{-7/8} + 0.8 \left( \frac{M}{G^* B^3} \right) \left( \frac{2D}{B} \right)^{-5/3} \quad \text{H-10}$$

The accuracy of Equation H-9 and H-10 has been verified for the following ranges of parameters:  
 $1 \leq D/B \leq 10$  and  $E_c/E_r \geq 1$ .

Shafts can be described as having intermediate stiffness whenever the slenderness ratio is bounded approximately as follows:

$$0.05 \left( \frac{E_c}{G^*} \right)^{1/2} < \frac{D}{B} < \left( \frac{E_c}{G^*} \right)^{2/7}$$

H-11

For the intermediate case, Carter and Kulhawy suggest that the displacements be taken as 1.25 times the maximum of either: (1) The predicted displacement of a rigid shaft with the same slenderness ratio ( $D/B$ ) as the actual shaft; or (2) the predicted displacement of a flexible shaft with the same modulus ratio ( $E_c/G^*$ ) as the actual shaft. Values calculated in this way should, in most cases, be slightly larger than those given by the more rigorous finite element analysis for a shaft of intermediate stiffness.

Carter and Kulhawy next considered a layer of soil of thickness  $D_s$  overlying rock as shown in Figure H-2. The analysis is approached by structural decomposition of the shaft and its loading, as shown in Figure H-2b. It was assumed that the magnitude of applied lateral loading is sufficient to cause yielding within the soil from the ground surface to the top of the rock mass. The portion of the shaft within the soil is then analyzed as a determinant beam subjected to known loading. The displacement and rotation of point  $A$  relative to point  $O$  can be determined by established techniques of structural analysis. The horizontal shear force ( $H_o$ ) and bending moment ( $M_o$ ) acting in the shaft at the rock surface level can be computed from statics, and the displacement and rotation at this level can be computed by the methods described previously. The overall groundline displacements can then be calculated by superposition of the appropriate parts.

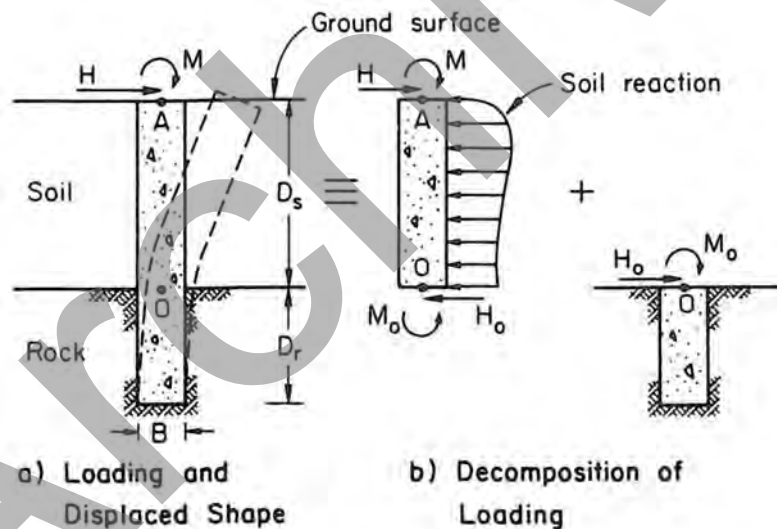


Figure H-2 Rock Socketed Shaft with Overlying Soil Layer (Carter and Kulhawy 1992)

Determination of the limiting soil reactions is recommended for the two limiting cases of cohesive soil in undrained loading ( $\phi = 0$ ) and frictional soil ( $c = 0$ ) in drained loading. Ultimate resistance for shafts in cohesive soils is based on the method of Broms (1964a), in which the undrained soil resistance ranges from zero at the ground surface to a depth of  $1.5B$  and has a constant value of  $9s_u$  below this depth, where  $s_u$  = soil undrained shear strength. For socketed shafts extending through a cohesionless soil layer, the following limiting pressure suggested by Broms (1964a) is assumed:

$$p_u = 3K_p \sigma'_v$$

H-12



$$K_p = \frac{1 + \sin \phi'}{1 - \sin \phi'}$$

in which  $\sigma_v'$  = vertical effective stress and  $\phi'$  = effective stress friction angle of the soil. For both cases (undrained and drained) solutions are given by Carter and Kulhawy (1992) for the displacement, rotation, shear, and moment at point  $O$  of Figure H-2. The contribution to groundline displacement and rotation from the loading transmitted to the rock mass ( $H_o$  and  $M_o$ ) is determined based on Eqs. H-5 and H-6 or Eqs. H-9 and H-10 and added to the calculated displacement and rotation at the top of the socket to determine overall groundline response.

Application of the proposed theory is described by Carter and Kulhawy (1992) through back-analysis of a single case involving field loading of a pair of rock-socketed shafts. The method has not been evaluated against a sufficient data base of field performance, and further research is needed to assess its reliability. The analysis was developed primarily for application to electrical transmission line foundations in rock, although the concepts are not limited to foundations supporting a specific type of structure. The approach is attractive for design purposes, because the closed-form equations can be executed by hand or on a spreadsheet.

Carter and Kulhawy (1992) state that the assumption of yield everywhere in the soil layer may represent an oversimplification, but that the resulting predictions of groundline displacements will overestimate the true displacements, giving a conservative approximation. However, the assumption that the limit soil reaction is always fully mobilized may lead to erroneous results by overestimating the load carried by the soil and thus underestimating the load transmitted to the socket. Furthermore, groundline displacements may be underestimated because actual soil resistance may be smaller than the limiting values assumed in the analysis.

### **H.1.2 Zhang, Ernst, and Einstein Nonlinear Model for an Elastic Shaft Embedded in an Elastic Rock Mass**

Zhang et al. (2000) extended the continuum approach to predict the nonlinear lateral load-displacement response of rock socketed shafts. The method considers subsurface profiles consisting of a soil layer overlying a rock layer. The deformation modulus of the soil is assumed to vary linearly with depth, while the deformation modulus of the rock mass is assumed to vary linearly with depth and then to stay constant below the shaft tip. Effects of soil and/or rock mass yielding on response of the shaft are considered by assuming that the soil and/or rock mass behaves linearly elastically at small strain levels and yields when the soil and/or rock mass reaction force  $p$  (force/length) exceeds the ultimate resistance  $p_{ult}$  (force/length).

Analysis of the loaded shaft as an elastic continuum is accomplished using the method developed by Sun (1994). The numerical solution is by a finite difference scheme and incorporates the linear variation in soil modulus and linear variation in rock mass modulus above the base of the shaft. Solutions obtained for purely elastic response are compared to those of Poulos (1971) and finite element solutions by Verruijt and Kooijman (1989) and Randolph (1981). Reasonable agreement with those published solutions is offered as verification of the theory, for elastic response.

The method is extended to nonlinear response by accounting for local yielding of the soil and rock mass. The soil and rock mass are modeled as elastic-perfectly plastic materials, and the analysis consists of the following steps:

1. For the applied lateral load  $H$  and moment  $M$ , the shaft is analyzed by assuming the soil and rock mass are elastic, and the lateral reaction force  $p$  of the soil and rock mass along the shaft is determined by solution of the governing differential equation and boundary conditions at the head of the shaft.
2. The computed lateral reaction force  $p$  is compared to the ultimate resistance  $p_{ult}$ . If  $p > p_{ult}$ , the depth of yield  $z_y$  in the soil and/or rock mass is determined.
3. The portion of the shaft in the unyielded soil and/or rock mass ( $z_y \leq z \leq L$ ) is considered to be a new shaft and analyzed by ignoring the effect of the soil and/or rock mass above the level  $z = z_y$ . The lateral load and moment at the new shaft head are given by:

$$H_o = H - \int_0^{z_y} p_{ult} dz \quad \text{H-14}$$

$$M_o = M + Hz_y - \int_0^{z_y} p_{ult} (z_y - z) dz \quad \text{H-15}$$

4. Steps 2 and 3 are repeated and the iteration is continued until no further yielding of soil or rock mass occurs.
5. The final results are obtained by decomposition of the shaft into two parts which are analyzed separately, as illustrated previously in Figure H-2. The section of the shaft in the zone of yielded soil and/or rock mass is analyzed as a beam subjected to a distributed load of magnitude  $p_{ult}$ . The length of shaft in the unyielded zone of soil and/or rock mass is analyzed as a shaft with the soil and/or rock mass behaving elastically.

Ultimate resistance developed in the overlying soil layer is evaluated for the two conditions of undrained loading ( $\phi = 0$ ) and fully-drained loading ( $c = 0$ ). For fine-grained soils (clay), undrained loading conditions are assumed and the limit pressure is given by:

$$p_{ult} = N_p c_u B \quad \text{H-16}$$

$$N_p = 3 + \frac{\gamma'}{c_u} z + \frac{J}{2R} z \leq 9 \quad \text{H-17}$$

in which  $c_u$  = undrained shear strength,  $B$  = shaft diameter,  $\gamma'$  = average effective unit weight of soil above depth  $z$ , and  $J$  = a coefficient ranging from 0.25 to 0.5. For shafts in sand, a method attributed to Fleming et al. (1992) is given as follows:

$$p_{ult} = K_p^2 \gamma' z B \quad \text{H-18}$$

where  $K_p$  = Rankine coefficient of passive earth pressure defined by Equation H-11. Ultimate resistance of the rock mass is given by:

$$p_{ult} = (p_L + \tau_{max}) B \quad \text{H-19}$$

where  $\tau_{\max}$  = maximum shearing resistance along the sides of the shaft and  $p_L$  = normal limit resistance. The limit normal stress  $p_L$  is evaluated using the Hoek-Brown strength criterion with the strength parameters determined on the basis of correlations to Geological Strength Index (GSI). The resulting expression is:

$$p_L = \gamma'z + q_u \left( m_b \frac{\gamma'z}{q_u} + s \right)^a \quad \text{H-20}$$

According to Zhang et al. (2000), a computer program was written to execute the above procedure. Predictions using the proposed method are compared to results of field load tests reported by Frantzen and Stratten (1987) for shafts socketed into sandy shale and sandstone. Computed pile head deflections show reasonable agreement with the load test results. The method appears to have potential as a useful tool for foundations designers. Availability of the computer program is unknown. Programming the method using a finite difference scheme as described by Zhang et al. (2000) is also possible.

## H.2 Finite Element Soil Models

Software now exists that will permit the nonlinear analysis of drilled shafts or groups of drilled shafts using the finite element method (FEM) with relative ease on a high-end PC or a workstation, for example ABAQUS (Hibbett et al., 1996). FEM analysis is justified when the soil or rock conditions, foundation geometry or loading of the group is unusual. An example of a case in which a comprehensive FEM analysis might be conducted is for designing a group of drilled shafts that are to be socketed into sloping rock on a steep mountainside, in which it is necessary to use permanent tiebacks to secure the drilled shaft group to stable rock.

Archived

This page is intentional left blank.