



U.S. Department of Transportation
Federal Highway Administration

Errata

Date: July 25, 2024

Issuing Office: Federal Highway Administration—Office of Research,
Development, and Technology: Office of Safety and Operations
R&D

Address: Turner-Fairbank Highway Research Center, 6300 Georgetown
Pike, McLean, VA 22101

Name of Document: *Evaluation of Advisory Exit and Ramp Speed Signs*

FHWA Publication No.: FHWA-HRT-24-138

The following changes were made to the document after publication on the Federal Highway Administration website:

| Location | Incorrect Values | Corrected Values |
|-------------------|------------------|------------------|
| Page 20, table 14 | 40 | 70 |

TECHBRIEF



U.S. Department of Transportation
Federal Highway Administration

Turner-Fairbank
Highway Research Center

Research, Development,
and Technology
Turner-Fairbank Highway
Research Center
6300 Georgetown Pike
McLean, VA 22101-2296

<https://highways.dot.gov/research>

Evaluation of Advisory Exit and Ramp Speed Signs

FHWA Publication No.: FHWA-HRT-24-138

FHWA Contact: Laura Mero, (ORCID: 0000-0002-2048-9988),
Office of Safety and Operations Research and Development, (HRSO-30),
(202) 493-3377, laura.mero@dot.gov

INTRODUCTION

A past research effort initiated by the Federal Highway Administration (FHWA) found that the combined workload of guidance (i.e., selection of the vehicle path) and control (i.e., physical operation of the vehicle) in the vicinity of interchanges creates a particularly challenging environment for motorists (Katz et al. 2018). At interchange ramp locations, drivers use cues from the roadway geometry, pavement markings, and signs to determine the appropriate path and speed at these locations. Changes in both horizontal and vertical alignment on interchange ramps can make these locations particularly challenging. More crashes occur at freeway entrance and exit ramps than on other segments of interstate highways, and run-off-road crashes (for which speed is often a factor) are the most common types of crashes on exit ramps (McCartt, Northrup, and Retting 2004).

The 2009 *Manual on Uniform Traffic Control Devices for Streets and Highways* (MUTCD)¹ included two advisory speed signs for use at exits: the Advisory Exit Speed (W13-2) sign for use along the deceleration lane and the Advisory Ramp Speed (W13-3) sign for use on the ramp to confirm the advisory speed, as shown in figure 1 (FHWA 2009). The MUTCD indicates that the Horizontal Alignment sign may be combined with an Advisory Exit Speed or Advisory Ramp Speed sign to create a Combination Horizontal Alignment/Advisory Exit Speed (W13-6) sign and a Combination Horizontal Alignment/Advisory Ramp Speed (W13-7) sign, as shown in figure 2. The W13-6 and W13-7 signs are options in the 2009 MUTCD “where the severity of the exit ramp curvature might not be apparent to road users in the deceleration lane or where the curvature needs to be specifically identified as being on the exit ramp rather than on the mainline” (FHWA 2009).

Figure 1. Illustration. Advisory Exit and Ramp Speed signs (FHWA 2009).



Source: FHWA.

¹This project was initiated under the 2009 MUTCD. The 11th Edition of the MUTCD was issued prior to the publication of this technical brief.

Past research indicates that advance warning signs can reduce crashes when applied appropriately and uniformly (Lyles and Taylor 2006; Ismail et al. 2011) and that consistency is critical to providing clear guidance to drivers (Katz et al. 2018). However, a National Committee on Uniform Traffic Control Devices Task Force as well as another recent study (Katz et al. 2018) determined inconsistencies exist in the application of advisory exit speed traffic control devices. These inconsistencies include the wording used on signs (“Exit” versus “Ramp”), sign placement, the basis for speed designation, and sign sequence. This research project, which occurred under the Traffic Control Devices Pooled Fund Study (TCD PFS), attempts to remedy these inconsistencies.

OBJECTIVE

This effort aimed to evaluate and produce uniform recommendations for Advisory Exit and Ramp Speed signs (W13-2 and W13-3) and Combination Horizontal Alignment/Advisory Exit and Ramp Speed signs (W13-6 and W13-7), including basis for speed designation, use of “Exit” versus “Ramp,” effects of sign placement, and optimization of sign sequence.

APPROACH

The research team used a three-phase approach to evaluate the applications of Advisory Exit and Ramp Speed signs (W13-2 and W13-3) and Combination Horizontal Alignment/Advisory Exit and Ramp Speed signs (W13-6 and W13-7), which included a literature and state-of-practice review, a laboratory comprehension study, and a field study. Although Advisory Exit and Ramp Speed signs and Combination Horizontal Alignment/Advisory Exit and Ramp Speed signs were the focus of the project, the team also examined other types of signs (e.g., Horizontal Alignment Warning signs with Advisory Speed plaques) that are commonly used in conjunction with Advisory Exit and Ramp Speed signs.

The research team used the findings of the state-of-practice review, and discussions with FHWA and the TCD PFS members, to finalize the signing conditions for the laboratory study. The research team gathered information on motorist comprehension of the signs from the laboratory study to determine the signing approaches to evaluate in the field study. The field study evaluated signing at seven different sites across two States to evaluate driver behavior in response to the signs.

Figure 2. Illustration. Combination Horizontal Alignment/ Advisory Exit and Ramp Speed signs (FHWA 2009).



Source: FHWA.

LITERATURE AND STATE-OF-PRACTICE REVIEW

Method

The team used the literature and state-of-practice review to identify research and signing practices related to the project objective. The specific activities included a review of the following:

- Relevant research, including published literature, FHWA publications, and other resources.
- The 2009 MUTCD and Notice of Proposed Amendments (NPA) for the 11th Edition of the MUTCD.
- State supplements to the MUTCD and other relevant State documents (e.g., engineering guidelines).
- Feedback on State practices provided by 11 TCD PFS member organizations.
- A sample of signing at 5 interchanges in each of the 50 States obtained via an online mapping service.

Results

Table 1 provides an overview of the findings.

The state-of-practice review revealed additional practices for consideration during evaluation, primarily related to sign sequence. For example, staggered advisory speed reduction where the advisory speed provided on the deceleration lane is higher than the advisory speed provided at the beginning of the ramp and within the ramp.

Table 1. Overview of literature and state-of-practice review findings.

| Category of Evaluation | Overview of Relevant Literature and State-of-Practice Findings |
|-------------------------------|---|
| Basis for speed designation | <ul style="list-style-type: none"> Findings suggest that most States are using standard practices that involve a ball bank indicator or accelerometer to determine advisory speeds; the findings did not identify additional approaches other than the standard practices (e.g., ball bank indicator or accelerometer). |
| Use of “Exit” versus “Ramp” | <ul style="list-style-type: none"> No research identified focused on the use of “Exit” versus “Ramp”; however, one study suggested that wording may not be as noticeable or important to road users as other sign elements (Voigt, Stevens, and Borchardt 2008). Eleven States provided feedback, and most indicated that they follow the MUTCD (i.e., “Exit” used along the deceleration lane and “Ramp” used on the exit ramp past the gore), with a few indicating a different approach: <ul style="list-style-type: none"> “Exit” for numbered exits; “Ramp” for nonnumbered exits. “Exit” when connecting to a conventional highway or crossroad and between freeway connections; “Ramp” when providing access to features such as rest areas where traffic must return directly to freeway. “Exit” for exit ramps; “Ramp” for freeway-to-freeway connector ramps. |
| Effects of sign placement | <ul style="list-style-type: none"> The research team found a study that evaluated the effects of Advisory Exit and Ramp Speed signs in general and found crash rates were higher on off ramps when advisory speed signs were not present (Lee and Abdel-Aty 2009). The research team did not find research that focused on the effects of the specific placement of Advisory Exit and Ramp Speed signs. |
| Optimization of sign sequence | <ul style="list-style-type: none"> A variety of practices and sign combinations are used throughout the country. The research team did not find any specific research to indicate the impacts of varying sign sequences. |

LABORATORY STUDY

The laboratory study focused on evaluating the use of “Exit” versus “Ramp” and effects of sign placement. Specifically, the laboratory study evaluated participant understanding of the intended sign message (comprehension) and participant expectations based on the signs they were viewing.

Laboratory data collection consisted of four parts: video simulations and open-ended questions, speed response questions, subjective ratings, and final questions. Each participant was exposed to a subset of the total signs and scenarios for the study.

Table 2 indicates the primary topics or research questions addressed by the laboratory study and which parts of the laboratory study each question addressed. The two roadway configurations used throughout the laboratory study were an exit with a downstream split on the ramp and a loop ramp with downstream tightening of the loop. The research team selected these configurations based on input from the TCD PFS members.

The laboratory study occurred in North Carolina and Virginia. Of the 199 participants, 98 were female and 101 were male. Participants ranged in age from 18 to 78 yr old (mean = 44 yr).

Table 2. Research questions and the laboratory study part(s) they addressed.

| Research Question | Part 1: Videos and Open-Ended Questions | Part 2: Speed Response Questions | Part 3: Subjective Ratings | Part 4: Final Questions |
|---|---|----------------------------------|----------------------------|-------------------------|
| Does the use of “Exit” versus “Ramp” influence what participants think is happening downstream? | ✓ | — | ✓ | ✓ |
| What, if any, sign elements or sign placement practices* influence participant understanding of what speed they should be traveling or when they need to slow down? | — | ✓ | — | — |
| What, if any, sign elements influence participant expectations regarding the severity of the curve in the exit or ramp? | ✓ | — | ✓ | — |
| What, if any, sign elements influence participant likelihood of compliance with the advisory speed? | — | — | ✓ | — |
| Do participants think there is a difference between an “Exit” and a “Ramp”? If so, what do they think the difference is? | — | — | — | ✓ |
| Does the type of sign or wording used on a sign influence participants’ ability to notice the speed change? | ✓ | — | — | — |
| What differences do participants tend to notice between two similar signs? | ✓ | — | — | — |

*Specific signing practices included 1) wording (Exit or Ramp), 2) sign placement (along the deceleration lane), 3) signing for limiting speed (i.e., lowest advisory speed for the exit ramp) early, 4) adding an additional sign near the gore, 5) adding an Advisory Speed plaque to the Exit Gore sign, and 6) various signing approaches in the loop downstream.

—No data.

The following sections present the method and results for each of the four parts of the laboratory study. The research team developed generalized linear mixed effects models to model comprehension as a function of participant characteristics (gender, age group) and sign characteristics (sign series or individual sign characteristics, including text, type of sign, and horizontal alignment). One model was generated for each research question. For the speed response questions, the research team made several individual comparisons to focus on the different signing approaches of interest, while accounting for familywise error rates as appropriate.

Part 1: Video Simulations and Open-Ended Questions

Method

The research team developed two types of video simulations for Part 1: sign series videos and difference videos; each video type is described below.

Sign Series Videos

For the sign series videos, participants viewed video-based simulations that began upstream of the deceleration lane and continued through the exit ramp. Each video displayed a unique sign series along the way and was shown from

the perspective of a driver, i.e., as if the participants were driving along the roadway. Each video paused at each relevant advisory sign, with the sign still in view, while the research team asked participants a series of questions. The questions varied depending on the sign that was in view, but in most cases, participants were asked the following:

- What does this sign mean?
- What action, if any, would you take if you saw this sign?
- Based on this sign, what do you expect to encounter as you exit?

At downstream split locations, the research team also asked participants questions pertaining to the perceived severity of the roadway geometry in each direction of the split.

Using the videos, the research team focused on evaluating the signing approaches included in the 2009 MUTCD. Figure 3 depicts the signing alternatives for the split videos, and figure 4 depicts the signing alternatives for the loop videos. Additional signs (i.e., from State use or NPA for the 11th Edition of the MUTCD) were evaluated during the speed response questions and subjective ratings parts of the laboratory study.

Figure 3. Illustrations. Signing alternatives for split videos.

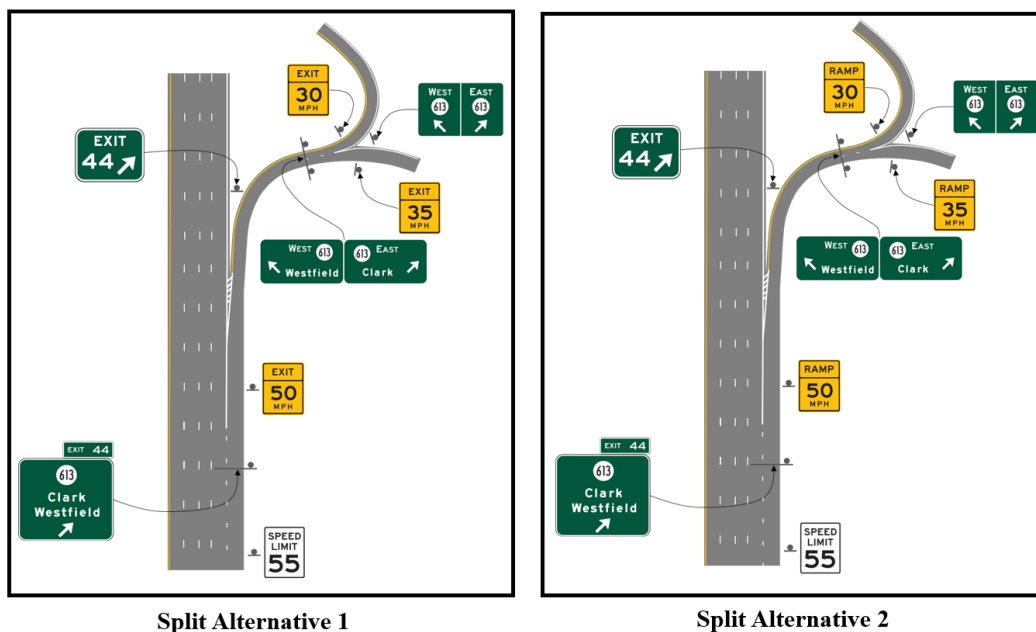

Source: FHWA.

Figure 4. Illustrations. Signing alternatives for loop videos (based on figure 2C-3 in the 2009 MUTCD).

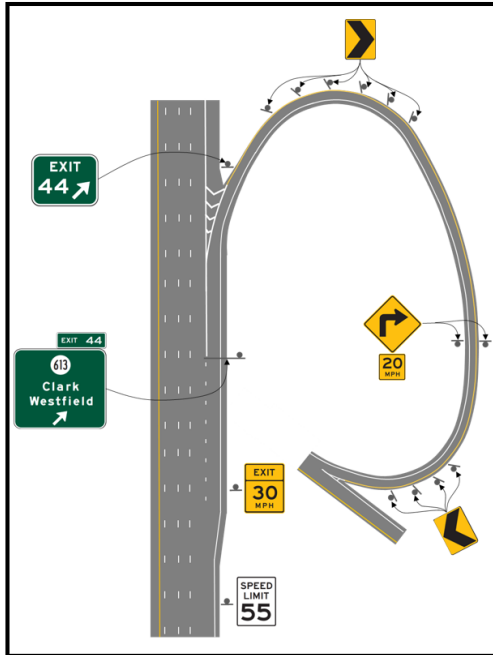

Loop Alternative 1

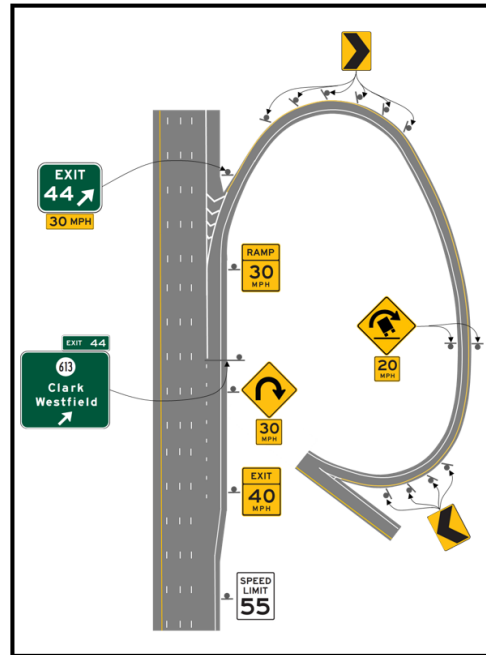

Loop Alternative 2

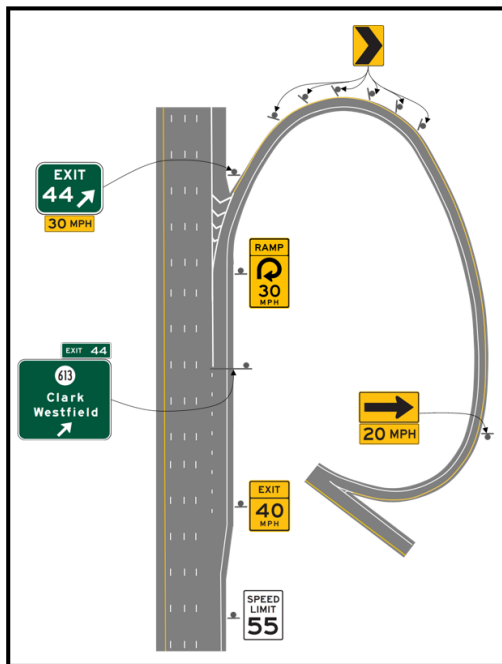

Loop Alternative 3

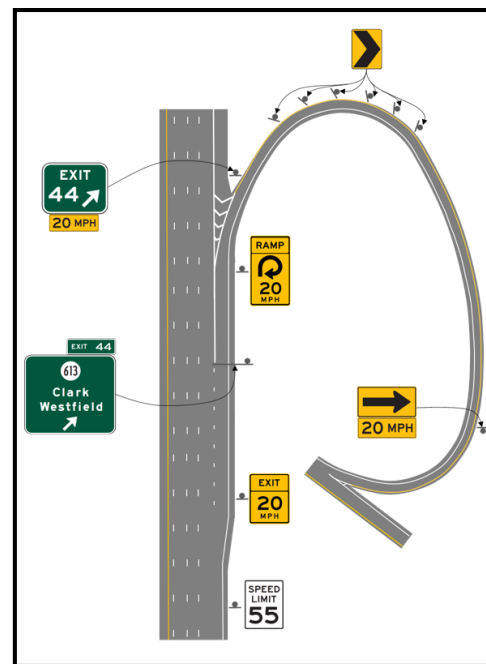

Loop Alternative 4

Source: FHWA.







Difference Videos

In addition to the sign series videos described in the previous section, the research team developed three difference videos to examine whether the type of sign or wording used on a sign influenced participants' ability to

notice the speed change and what differences participants tend to notice between two similar signs. These videos began upstream of the deceleration lane and ended near the exit gore. Each video displayed a unique two-sign series along the way. As shown in table 3, each of these

signing alternatives varied by sign type (both Advisory Speed signs, both Combination Horizontal Alignment/Advisory Speed signs, and a combination), and the two signs in each series varied by wording (“Exit” or “Ramp”). Regardless of the signing alternative, the advisory speed was higher (45 mph) at the beginning of the deceleration lane and lower (35 mph) downstream near the exit gore. The videos paused after passing the second sign, with neither sign in view. The research team asked participants if they noticed a difference between the signs and, if so, what difference they noticed.

Table 3. Scenarios for reducing speed along the deceleration lane.

| Alternative | 1st Sign | 2nd Sign |
|-------------|---|--|
| A |  |  |
| B |  |  |
| C |  |  |

Results

The findings from this part of the laboratory study were limited. Participant responses provided some insight into what participants expected to encounter as they exit (e.g., traffic, a stop, a merge onto another roadway); however, these responses typically did not vary by signing alternative. The few findings that were statistically significant tended to be in line with the findings from other laboratory study sections (e.g., speed response questions or ratings).

For example, when the videos with the loop configuration paused at the downstream loop location (see figure 7 for sign locations), participants were more likely to expect a sharp curve or turn when viewing Alternative 1 or Alternative 2 than when viewing Alternative 3 or Alternative 4, as depicted in figure 5. Alternatives 1 and 2 presented double (one on each side of the road) horizontal alignment warning signs with Advisory Speed plaques, whereas Alternatives 3 and 4 presented large arrows with Advisory Speed plaques.

Figure 5. Graph. Percentage of participants who expected to encounter a sharp curve or turn, by loop sign alternative, at the downstream loop location.

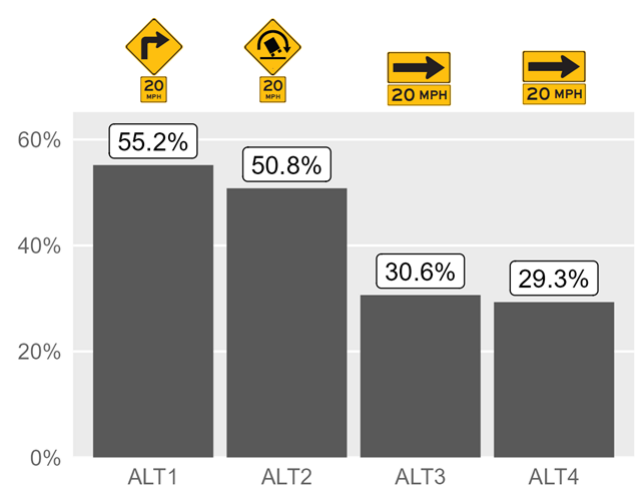







Source: FHWA.

Another statistically significant finding for the loop configuration was that when asked “What do you expect the exit ramp to do in terms of direction, severity, etc.” at the advance sign location (i.e., the beginning of the deceleration lane; see figure 7 for sign locations), participants were more likely to report the ramp as being “sharper” and less likely to use words like “gentler” when viewing Alternative 2 or Alternative 4 than when viewing Alternative 1 or Alternative 3. Alternative 4 presented a 20 mph Advisory Exit Speed sign at this location, and all other alternatives presented a 30 mph or 40 mph Advisory Exit sign at this location. Although Alternative 2 presented a 40 mph Advisory Exit Speed sign at this location, it was closely followed by a horizontal alignment warning sign with a 30 mph Advisory Speed plaque. This sign was also in view when the participants were responding to this question.

For the videos with the split configuration, the two signing alternatives varied only by wording (exit versus ramp). Participants provided minimal responses that differed significantly by alternative, none of which were practically relevant.

For the videos in which participants were asked if they noticed a difference between two signs, participants were more likely to notice the advisory speeds shown on the signs than they were to notice a difference in wording. Table 4 includes the alternatives depicted in table 3 and the percentage of participants who noticed differences in the two signs within each alternative.

Table 4. Percentage of participants who noticed differences in advisory speed, wording, or sign type for each difference video sign alternative.

| Alternative | 1st Sign | 2nd Sign | Noticed difference in advisory speed (%) | Noticed difference in wording (%) | Noticed difference in sign type (%) | Did not notice any differences (%) |
|-------------|---|---|--|-----------------------------------|-------------------------------------|------------------------------------|
| A |  |  | 81 | 21 | N/A* | 16 |
| B |  |  | 86 | 2 | N/A* | 13 |
| C |  |  | 81 | 17 | 47 | 10 |

*This change was not applicable because both signs used in this alternative were the same type of sign.
N/A = not applicable.

Part 2: Speed Response Questions

Method

Next, participants completed Speed Response Forms, as depicted in figure 6, that included an illustration of a roadway geometry from part 1 (i.e., exit with a downstream split or loop with downstream tightening of the loop), a specific signing condition, and input boxes for speeds at specific locations along the exit or ramp. The locations of the speed input boxes remained constant within each roadway configuration. Eight speed input boxes were located on the downstream split geometries and 14 input boxes on the loop geometries. Participants were instructed, “Based on this series of signs, please indicate what speed you think you should be traveling at each of these locations.”

The research team developed 15 signing conditions for the exit with a downstream split roadway configuration, and 24 signing conditions for the loop with downstream tightening configuration to examine various signing practices that included the following:

- Wording (Exit or Ramp)
- Sign placement (along the deceleration lane)
- Signing for limiting speed (i.e., lowest advisory speed for the exit ramp) early
- Adding an additional sign near the gore
- Adding an Advisory Speed plaque (E13-1P) to the Exit Gore sign (E5-1 series)
- Signing approach in the loop downstream

Figure 6. Illustration. Example Speed Response Form.

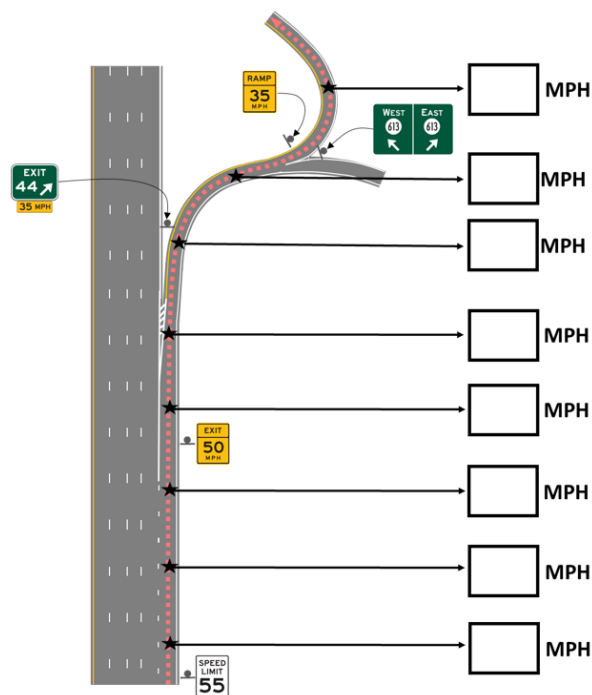

Source: FHWA.

Figure 7 depicts the relative placement of signs along the illustrated roadway. Table 5 and table 6 list the signing conditions, including relative placement of signs (as indicated in figure 7) for the split and loop configurations, respectively.

Figure 7. Illustration. Speed Response Form sign placement locations for split (left) and loop (right).

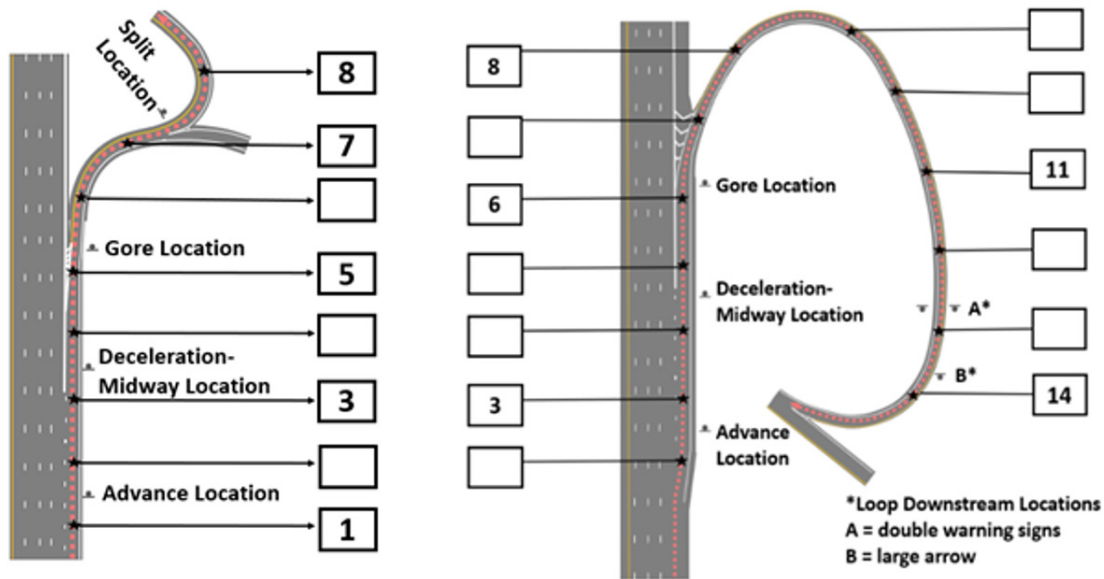

Source: FHWA.

Table 5. Speed Response Form signing conditions for exit with a downstream split.

| Condition | Advance Location | Deceleration-Midway Location | Gore Location | Split Location | Speed on Exit Gore Sign? |
|-----------|----------------------|------------------------------|----------------------|----------------------|--------------------------|
| S-1 | — | — | — | — | — |
| S-2 | — | Advisory Exit 50 mph | — | Advisory Exit 35 mph | — |
| S-3 | — | Advisory Ramp 50 mph | — | Advisory Ramp 35 mph | — |
| S-4 | — | Advisory Exit 50 mph | — | Advisory Ramp 35 mph | — |
| S-5 | — | Advisory Ramp 50 mph | — | Advisory Exit 35 mph | — |
| S-6 | — | Advisory Exit 50 mph | — | Advisory Exit 35 mph | 35 mph |
| S-7 | — | Advisory Exit 50 mph | — | Advisory Ramp 35 mph | 35 mph |
| S-8 | Advisory Exit 50 mph | — | — | Advisory Exit 35 mph | — |
| S-9 | — | — | Advisory Exit 50 mph | Advisory Exit 35 mph | — |
| S-10 | Advisory Exit 50 mph | Advisory Exit 50 mph | — | Advisory Exit 35 mph | — |

Table 5. Speed Response Form signing conditions for exit with a downstream split. (Continued)

| Condition | Advance Location | Deceleration-Midway Location | Gore Location | Split Location | Speed on Exit Gore Sign? |
|-----------|------------------|------------------------------|----------------------|----------------------|--------------------------|
| S-11 | — | Advisory Exit 50 mph | Advisory Exit 45 mph | Advisory Exit 35 mph | — |
| S-12 | — | Advisory Exit 50 mph | Advisory Ramp 50 mph | Advisory Ramp 35 mph | — |
| S-13 | — | Advisory Exit 35 mph | — | Advisory Exit 35 mph | — |
| S-14 | — | Advisory Exit 50 mph | Curve Warning 50 mph | Advisory Exit 35 mph | — |
| S-15 | — | Advisory Ramp 50 mph | Curve Warning 50 mph | Advisory Ramp 35 mph | — |

—No data.

Table 6. Speed Response Form signing conditions for loop with downstream tightening.

| Condition | Advance Location | Deceleration-Midway Location | Gore Location | Speed on Exit Gore Sign? | Loop Downstream Location | Chevrons in Downstream Loop Location? |
|-----------|----------------------|------------------------------|----------------------|--------------------------|---|---------------------------------------|
| L-1 | — | — | — | — | — | Yes |
| L-2 | Advisory Exit 30 mph | — | — | — | Double Warning 20 mph | Yes |
| L-3 | Advisory Exit 30 mph | — | — | — | Double Warning 20 mph Large Arrow 20 mph | — |
| L-4 | Advisory Exit 30 mph | — | — | — | Large Arrow 20 mph | — |
| L-5 | Advisory Exit 30 mph | — | — | — | Large Arrow 20 mph | Yes |
| L-6 | Advisory Exit 40 mph | Warning Hairpin 30 mph | Advisory Ramp 30 mph | 30 mph | — | Yes |
| L-7 | Advisory Exit 40 mph | — | Combo Ramp 30 mph | 30 mph | — | Yes |
| L-8 | Advisory Exit 40 mph | — | Combo Ramp 30 mph | 30 mph | Double Warning 20 mph | Yes |
| L-9 | Advisory Exit 40 mph | — | Combo Ramp 20 mph | 20 mph | — | Yes |
| L-10 | Advisory Exit 40 mph | — | Combo Ramp 20 mph | — | — | Yes |
| L-11 | Advisory Exit 40 mph | Warning Hairpin 30 mph | Advisory Ramp 30 mph | 30 mph | Double Warning 20 mph | Yes |

Table 6. Speed Response Form signing conditions for loop with downstream tightening. (Continued)

| Condition | Advance Location | Deceleration-Midway Location | Gore Location | Speed on Exit Gore Sign? | Loop Downstream Location | Chevrons in Downstream Loop Location? |
|-----------|----------------------|------------------------------|----------------------|--------------------------|--------------------------|---------------------------------------|
| L-12 | Advisory Exit 20 mph | — | — | — | Double Warning 20 mph | Yes |
| L-13 | Advisory Exit 20 mph | — | — | 20 mph | Double Warning 20 mph | Yes |
| L-14 | Advisory Ramp 20 mph | — | — | — | Double Warning 20 mph | Yes |
| L-15 | Combo Exit 20 mph | — | — | — | Double Warning 20 mph | Yes |
| L-16 | — | Combo Exit 20 mph | — | — | Double Warning 20 mph | Yes |
| L-17 | — | — | Combo Exit 20 mph | — | Double Warning 20 mph | Yes |
| L-18 | — | Combo Exit 20 mph | — | — | — | Yes |
| L-19 | Advisory Exit 40 mph | Warning Hairpin 30 mph | Advisory Exit 30 mph | 30 mph | — | Yes |
| L-20 | Advisory Ramp 40 mph | Warning Hairpin 30 mph | Advisory Ramp 30 mph | 30 mph | — | Yes |
| L-21 | Advisory Exit 40 mph | Warning Hairpin 30 mph | Advisory Ramp 30 mph | 30 mph | W1-13 20 x 2 | Yes |
| L-22 | Advisory Exit 40 mph | — | Combo Ramp 30 mph | 30 mph | Large Arrow 20 mph | — |
| L-23 | Advisory Exit 20 mph | — | Combo Ramp 20 mph | 20 mph | Double Warning 20 mph | Yes |
| L-24 | Advisory Exit 20 mph | — | Combo Ramp 20 mph | 20 mph | Large Arrow 20 mph | — |

—No data.

Results

Table 5 and table 6 show all signing conditions evaluated in the Speed Response Forms, and various comparisons of these conditions were made. The overall results of the speed response questions are summarized in the following sections by the specific aspect of sign placement or sign sequence of interest. The box numbers referenced in table 7 through table 12 are indicated in figure 7. For the split configuration, only speed input boxes numbered 1, 3, 5, 7, and 8 were included in data analysis. For the loop configuration, only speed input boxes numbered 1, 3, 6, 8, 11, and 14 were included in data analysis.

Wording (Exit versus Ramp). The research team made five comparisons to determine whether wording influenced participant responses. Each of these comparisons and relevant findings are listed in table 7. Overall, the use of “Exit” versus “Ramp” did not typically influence participant responses. In one comparison, the alternative using “Exit” resulted in lower reported speeds, and in another instance, the alternative using “Ramp” resulted in lower reported speeds; however, in either case, the differences were minimal (approximate differences of 0.3–0.6 mph).

Table 7. Sample comparisons made to examine the effect of wording.

| Conditions Compared | Description | Overview of Results |
|-----------------------|---|---|
| S-2; S-3; S-4; S 5 | Each condition consisted of a two-sign series using a different combination of wording (S-2 used Exit and Exit; S-3 used Ramp and Ramp; S-4 used Exit and Ramp; S-5 used Ramp and Exit). | Results did not vary significantly. |
| S-11; S-12 | Each condition consisted of a three sign series with a different combination of wording (S-11 used Exit and Exit and Exit; S-12 used Exit and Ramp and Ramp). | Results did not vary significantly. |
| S-14; S-15 | Each condition consisted of a three sign series with a different combination of wording (S-14 used Exit and Exit; S 15 used Ramp and Ramp) and both used a Curve Warning sign at the gore location. | At box 1, reported speeds were lower for S-14 (54.4 mph) than for S-15 (55.0 mph, $p<0.05$). |
| L-12; L-14 | Conditions were identical except that L 12 used "Exit" on the advance sign and L-14 used "Ramp" on the advance sign. | Results did not vary significantly. |
| L-19; L-20; L-6 | Conditions were identical except that L 19 used "Exit" on all signs, L-20 used "Ramp" on all signs, and L-6 used "Exit" and then "Ramp." | At box 11, reported speeds were higher for L 19 (31.9 mph) than for L-20 (30.6 mph, $p<0.05$) and for L-6 (30.1 mph, $p<0.05$). |

Table 8. Sample comparisons made to examine effects of sign placement.

| Conditions Compared | Description | Overview of Results |
|---------------------------|--|---|
| S-2; S-8; S-9 | Differ only by location of Advisory Exit sign on deceleration lane. S-8 has it in Advance location, S-2 has it in Deceleration-Midway location, S-9 has it at gore location. | <ul style="list-style-type: none"> At box 1, reported speeds were lower for S-8 (53.5 mph) than for S-2 (54.5 mph, $p<0.01$) and S-9 (55.0 mph, $p<0.001$). At box 3, reported speeds were lower for S-8 (49.8 mph) than for S-2 (52.2 mph, $p<0.001$) and S-9 (53.7 mph, $p<0.001$). Reported speeds were lower for S-2 then for S-9 ($p<0.01$). At box 5, reported speeds were higher for S-9 (50.3 mph) than for S-2 (48.3 mph, $p<0.001$) and S-8 (47.6 mph, $p<0.001$). |
| L-15; L 16; L-17 | Differ only by location of Combination Exit sign on deceleration lane. L-15 has it in Advance location, L-16 has it in Deceleration-midway location, L-17 has it at gore location. | <ul style="list-style-type: none"> At box 1, reported speeds were lower for L-15 (52.7 mph) than for L-16 (54.8 mph, $p<0.01$) and L-17 (54.5 mph, $p<0.05$). At box 3, reported speeds were lower for L-15 (37.9 mph) than for L-16 (49.7 mph, $p<0.001$) and L-17 (50.0 mph, $p<0.001$). |
| L-12; L 13; L 23; L-24 | Each condition signs for the limiting speed at the Advance location. L-12 and L-13 have no sign near the gore while L 23 and L-24 have a Combination Ramp sign near gore. | At box 6, reported speeds were lower for L-23 (23.6 mph) than for L-12 (28.2 mph, $p<0.001$) and L-13 (28.4 mph, $p<0.001$). Reported speeds were lower for L-24 (24.5 mph) than for L 12 and L-13 ($p<0.05$). |

Sign placement (along the deceleration lane).

Table 8 presents comparisons and relevant findings related to sign placement along the deceleration lane.

The earlier the advisory speed sign is placed on the deceleration lane, the earlier participants reported they needed to slow down.

Signing for the limiting speed along the deceleration lane. Two comparisons were made to determine the effects of signing for the limiting speed along the deceleration lane. Participants thought they needed to slow down earlier when the limiting speed was placed on the deceleration lane (rather than signing for a higher advisory speed on the deceleration lane).

Additional sign near the gore. Table 10 presents comparisons and relevant findings related to adding an additional sign near the gore. Although results were mixed, adding an additional sign near the gore typically resulted in lower reported speeds regardless of what type of sign was added near the gore (Advisory Speed sign, Combination Horizontal Alignment/Advisory Speed sign, or a Warning sign with an Advisory Speed plaque).

Table 9. Sample comparisons to examine effects of signing for the limiting speed early.

| Conditions Compared | Description | Overview of Results |
|---------------------|--|---|
| S-2; S-13 | Each condition was identical except that S-2 signed for a 50 mph advisory speed on the deceleration lane and S-13 signed for a 35-mph advisory speed on the deceleration lane. | At box 3, reported speeds were lower for S-13 (45.0 mph) than for S-2 (52.2 mph, $p < 0.001$). At box 5, reported speeds were lower for S-13 (36.2 mph) than for S-2 (48.2 mph, $p < 0.001$). At box 7, reported speeds were lower for S-13 (33.9 mph) than for S-2 (39.6 mph, $p < 0.001$). |
| L-15; L-16; L-17 | Each condition used the Combination Horizontal Alignment/Advisory Speed sign (20 mph), at different locations (L-15 at advance location, L-16 at deceleration-midway location; L-17 at gore location). | At box 1, reported speeds were lower for L-15 (52.7 mph) than for L-17 (54.5 mph, $p < 0.05$) and L-16 (54.8 mph, $p < 0.01$). |

Table 10. Sample comparisons to examine effects of adding a sign near the gore.

| Conditions Compared | Description | Overview of Results |
|------------------------|--|---|
| S-2; S-11 | Differ only by sign near gore. S-2 uses none; S-11 uses Advisory Exit Speed sign. | At box 5, reported speeds were lower for S-11 (46.5 mph) than for S-2 (48.3 mph). |
| S-4; S-12 | Differ only by sign near gore. S-4 uses none; S-12 uses Advisory Ramp Speed sign. | Results did not vary significantly. |
| S-2; S-14 | Differ only by sign near gore. S-2 uses none; S-14 uses Curve Warning sign. | Results did not vary significantly. |
| S-3; S-15 | Differ only by sign near gore. S-3 uses none; S-15 uses Curve Warning sign. | <ul style="list-style-type: none"> At box 5, reported speeds were lower for S-3 (52.4 mph) than for S-15 (49.5 mph, $p < 0.01$). At box 7, reported speeds were lower for S-3 (37.5 mph) than for S-15 (39.7 mph). At box 8, reported speeds were lower for S-3 (34.1 mph) than for S-15 (34.8 mph, $p < 0.05$). |
| L-12; L-13; L-23; L-24 | Each condition signs for the limiting speed at the Advance location. L-12 and L-13 have no sign near the gore, while L-23 and L-24 have a Combination Ramp sign near the gore. | At box 6, reported speeds were lower for L-23 (23.6 mph) than for L-12 (28.2 mph, $p < 0.001$) and L-13 (28.4 mph, $p < 0.001$). Reported speeds were lower for L-24 (24.5 mph) than for L-12 and L-13 ($p < 0.05$). |

Advisory Speed on Exit Gore sign. Table 11 presents comparisons and relevant findings related to adding an Advisory Speed plaque to the Exit Gore sign. Though the differences were statistically significant, the results were mixed by whether scenarios with the Advisory

Speed plaque resulted in higher or lower reported speeds. Additional research may be needed to determine whether other influencing factors exist such as other signs in the series.

Table 11. Sample comparisons to examine effects of Advisory Speed plaque on Exit Gore sign.

| Conditions Compared | Description | Overview of Results |
|-----------------------|--|---|
| L-12; L-13 | Differ only by presence of Advisory Speed plaque on Exit Gore sign; L-13 had a speed plaque, L-12 did not. | At box 11, reported speeds were lower for L-12 (22.9 mph) than for L-13 (24.9 mph, $p < 0.05$). |
| L-9; L-10 | Differ only by presence of Advisory Speed plaque on Exit Gore sign; L-9 had a speed plaque, L-10 did not. | <ul style="list-style-type: none"> At box 8, reported speeds were lower for L-9 (26.2 mph) than for L-10 (29.6 mph, $p < 0.001$). At box 11, reported speeds were lower for L-9 (28.2 mph) than for L-10 (32.0 mph, $p < 0.001$). At box 14, reported speeds were lower for L-9 (25.5 mph) than for L-10 (28.2 mph, $p < 0.05$). |
| S-2; S-6 | Differ only by presence of Advisory Speed plaque on Exit Gore sign; S-6 had a speed plaque, S-2 did not. | At box 7, reported speeds were lower for S-6 (36.4 mph) than for S-2 (39.6 mph, $p < 0.001$). |
| S-4; S-7 | Differ only by presence of Advisory Speed plaque on Exit Gore sign; S-7 had a speed plaque, S-4 did not. | At box 7, reported speeds were lower for S-7 (35.7 mph) than for S-4 (38.6 mph, $p < 0.01$). |
| S-2; S-6; S-4; S 7 | Differ only by presence of Advisory Speed plaque on Exit Gore sign. | At box 7, reported speeds were higher for S-4 (39.6 mph) than for S-6 (36.4 mph, $p < 0.001$) and S-7 (35.7 mph, $p < 0.001$). |

Signing approach in the loop downstream. Several sign alternatives were tested in the downstream loop location: double Turn warning signs, double Truck Rollover warning signs, Large Arrow sign, and chevrons only. Table 12 shows the comparisons that were made and provides an overview of results. Reported speeds were higher when using chevrons only compared to all other sign types tested in the downstream loop location. Some results suggested that double warning signs may lead to lower reported speeds than the Large Arrow, though these results varied depending on the sequence of signs. For example, participants reported speeds slightly lower with double turn warning signs in the

downstream loop location than with the Large Arrow in scenarios where there was a staggered advisory speed reduction along the deceleration lane. However, this difference was not seen in other scenarios where the limiting advisory speed was signed from the beginning of the deceleration lane; this difference was presumably because they reported that they would have already slowed down earlier along the deceleration lane, making the difference due to the downstream loop signing less prevalent. Some results also suggested that chevrons used in conjunction with the Large Arrow may lead to lower reported speeds compared to chevrons or Large Arrow alone.

Table 12. Sample comparisons to examine effects of signing type in loop downstream.

| Conditions Compared | Description | Overview of Results |
|---------------------|--|---|
| L-6; L-11; L-21 | Differ only by the downstream loop location: L-6 has no sign, L-11 has double warning signs, and L-21 has double W1-13 signs. | At box 14, reported speeds were higher for L-6 (27.8 mph) than for L-21 (21.7 mph, $p < 0.001$) and for L 11 (20.7 mph, $p < 0.001$). |
| L-7; L-8; L-22 | Differ only by the downstream loop location: L-7 has chevrons only, L-8 has double warning signs with chevrons; L-22 has Large Arrow only. | At box 14, reported speeds were higher for L-7 (27.8 mph) than for L-22 (22.2 mph, $p < 0.001$) and for L-8 (20.9 mph, $p < 0.001$); reported speeds were also higher for L-22 than for L 8 ($p < 0.05$). |
| L-23; L-24 | Conditions differ only by downstream loop signing. L-23 has double warning signs; L-24 has Large Arrow. | Results did not vary significantly. |
| L-2; L-3; L-4; L 5 | These condition test variations with Large Arrow or double warning signs with and without chevrons. | At box 11, L-4 resulted in higher reported speeds (31.1 mph) than L-2 (28.9 mph, $p < 0.01$) and L 3 (28.3 mph, $p < 0.01$). |

Part 3: Subjective Ratings

Method

Next, participants viewed individual signs on a relevant roadway background and were asked to respond to two rating questions. The subjective ratings were used to determine what, if any, sign elements influenced participants: 1) expectations regarding the severity of the curve as they are leaving the highway, or 2) reported likelihood of compliance with the advisory speed.

As shown in figure 8, the research team developed 36 signs that varied by wording (i.e., “Exit” or “Ramp”), the horizontal alignment depicted on the sign (i.e., none, Turn Arrow, Hairpin Curve, Truck Rollover, or 270-degree loop), type of sign (i.e., Advisory Speed, Combination Horizontal Alignment/Advisory Speed, or Warning sign with Advisory Speed plaque) and advisory speed (i.e., 15, 25, 35, or 45 mph).

Figure 8. Illustration. Test signs used for subjective ratings.

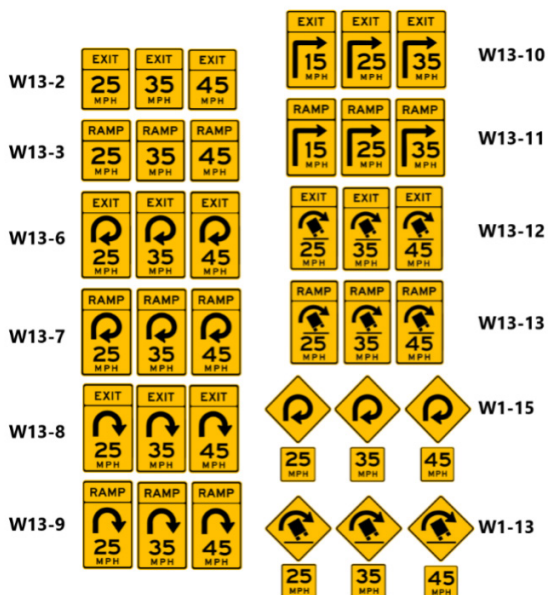

Source: FHWA.

Participants were told the posted speed on the highway (which was always 55 mph) and to imagine they were planning to take the next exit. With the test sign in view, participants provided severity and compliance ratings for each sign. For the severity rating, participants were instructed, “Based on the sign that you are currently viewing, please rate how severe or sharp the curve will be as you exit,” with a scale from 1 to 7 where 1 = gradual, gentle, or soft, 4 = moderate, and 7 = sharp, severe, or sudden. For the compliance rating, participants were instructed, “Based on the same sign that you are currently viewing, please indicate how likely you would be to slow to the speed posted on this sign,” with a scale from 1 to 5 where 1 = very unlikely, 2 = somewhat unlikely, 3 = neutral, 4 = somewhat likely, and 5 = very likely.

Results

When considering the sign elements individually, ratings did not vary significantly by the wording (Exit versus Ramp) used on the sign. The ratings did vary significantly by advisory speed for both the compliance rating and the severity rating. Specifically, participants tended to rate curves as more severe and indicate that they were more likely to comply with the advisory speed when shown lower advisory speeds as compared to higher advisory speeds. The ratings also varied by the horizontal alignment shown on the sign, as depicted in figure 9.

Additionally, as perceived severity of the exit increased, reported compliance with the advisory speed also increased, as depicted in figure 10.

Figure 9. Graphs. Compliance (left) and severity (right) rating results by horizontal alignment.

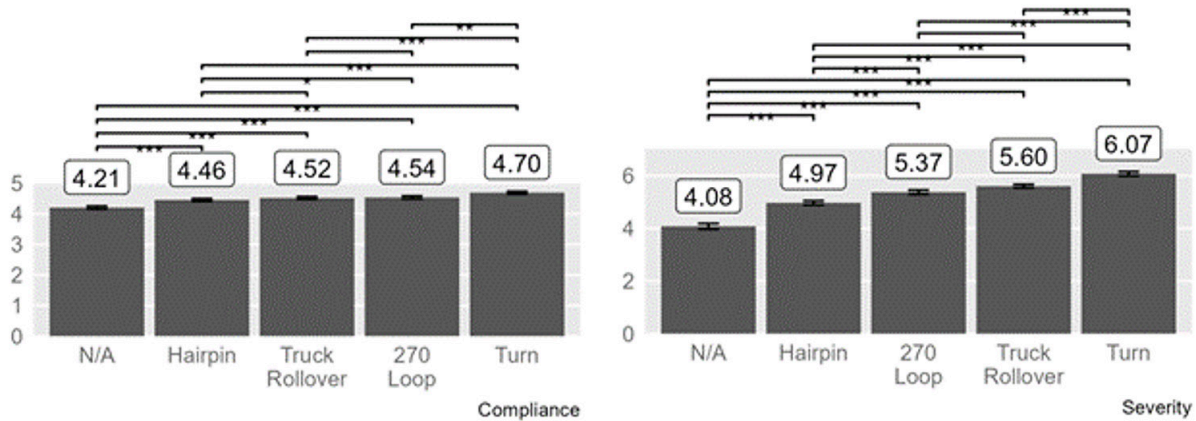

Source: FHWA.

*** $p < 0.001$.

** $p < 0.01$.

* $p < 0.5$.

N/A = not applicable.

Figure 10. Graph. Interaction between severity and compliance ratings.

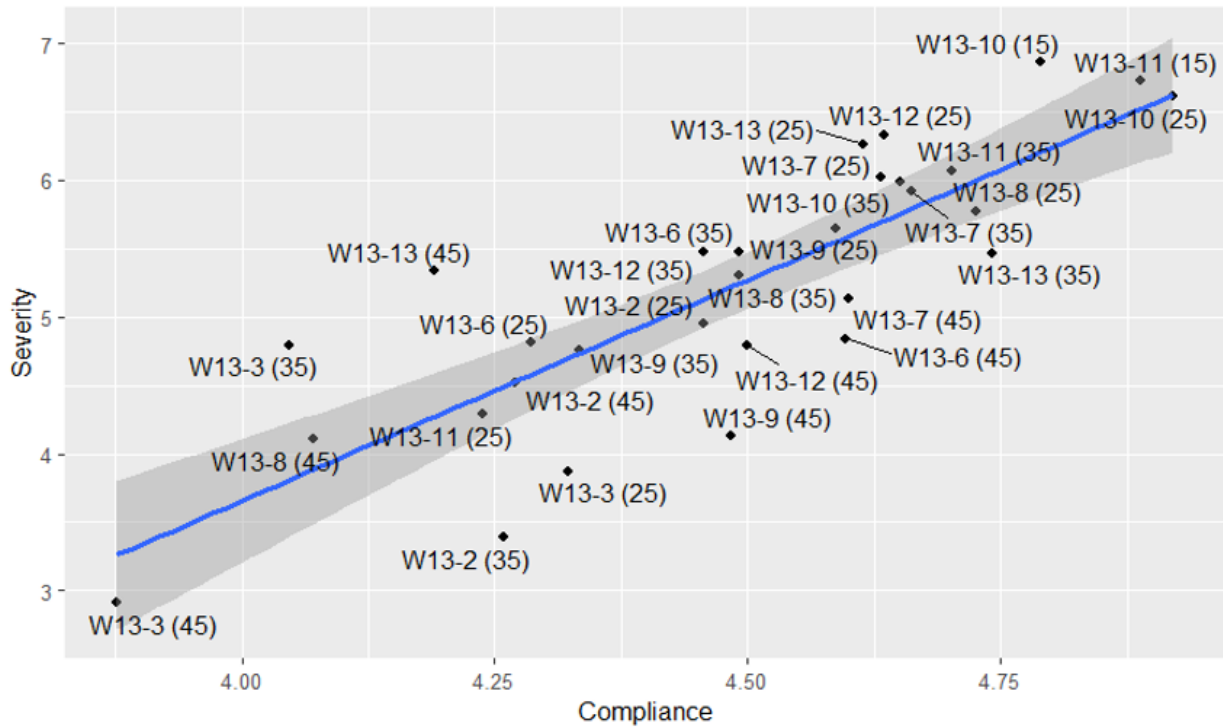

Source: FHWA.

Part 4: Final Questions

Method

Finally, participants were asked final questions to determine what participants thought the difference was, if anything, between an exit and a ramp and to determine their understanding of an advisory speed. Participants were shown an Advisory Exit Speed sign and an Advisory Ramp Speed sign side-by-side, as depicted in figure 11, and were asked three questions: 1) Do you think there is a difference between an “Exit” and a “Ramp”? If so, please describe what you think the difference is, 2) Do you think that the speeds shown on these signs are the mandatory speed or a recommended speed? and 3) Can you get a ticket for driving faster than 35 mph when these signs are posted?

Results

As shown in figure 12, the majority (82 percent) of participants thought there was a difference between an

Figure 11. Illustration. Signs shown for final questions.



Source: FHWA.

Exit and a Ramp. However, as indicated in table 13, the specific differences that were reported varied. Although 57 percent of participants thought the speed shown on the sign was a recommended speed and 43 percent thought it was a mandatory speed, most participants (63 percent) indicated they thought they could get a ticket for driving faster than the speed on the signs.

Figure 12. Graph. Participant responses to each of the final questions.

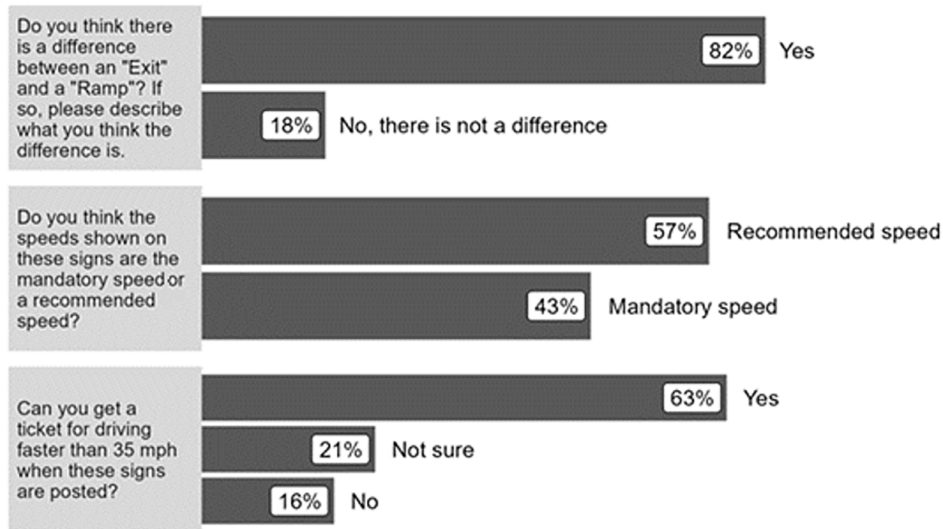

Source: FHWA.

Table 13. Specific differences between Exit and Ramp that participants reported.

| Response Category | Percentage of Responses |
|--|-------------------------|
| A ramp has an incline | 20.3 |
| An exit takes you off highway or to a different road; a ramp goes to another highway | 18.7 |
| Unclear or miscellaneous response | 14.6 |
| Exit is the beginning; ramp is after the exit | 10.6 |
| Exit is straight; ramp is curved | 9.8 |
| Exit is leaving a highway; ramp is entering a highway | 6.5 |
| Ramp is more severe | 5.7 |
| Exit is short or quick; ramp is longer | 4.9 |
| Exit comes to a stop or light | 4.1 |
| Ramp leads to an exit | 2.4 |
| Ramp is a type of exit | 2.4 |

Note: The individual responses provided by participants were coded into similar categories; these coded categories are shown in table 6.

Discussion

The laboratory study focused primarily on two of the four project focus areas: use of “Exit” versus “Ramp” and effects of sign placement. The following sections discuss the findings pertaining to each focus area, including relevant research questions that were addressed.

Use of “Exit” versus “Ramp”

Two laboratory study research questions pertained to the wording used on advisory speed signs: 1) Do participants think there is a difference between an “Exit” and a “Ramp”? If so, what do they think the difference is? and 2) Does the use of “Exit” versus “Ramp” influence what participants think is happening downstream?

The results of the final questions indicated that 82 percent of participants reported that they thought there was a difference between an “Exit” and a “Ramp.” However, when asked what, specifically, they thought the difference between an Exit and a Ramp is, the participants gave a wide variety of responses. This is, perhaps, not surprising given that the state-of-practice review revealed some variation in the use of “Exit” versus “Ramp” wording between States.

Although most participants reported a difference between an “Exit” and a “Ramp” when asked directly during the final questions, the results of the other laboratory study sections (i.e., video simulations and open-ended questions, speed response questions, and subjective ratings) showed minimal to no differences in participant responses based on the wording used. The findings from the video simulations and open-ended questions and from the subjective ratings suggest that the use of “Exit” versus “Ramp” did not tend to influence what participants thought was happening downstream.

Effects of Sign Placement

One laboratory study question pertained to sign placement: What, if any, sign elements or sign placement influence participant understanding of what speed they should be traveling or when they need to slow down?

The speed response questions addressed this research question. The findings suggested that, in most cases, the earlier the advisory speed sign was placed on the deceleration lane, the earlier participants tended to think they needed to slow down. Similarly, when signing for the limiting speed (i.e., the lowest advisory speed posted at the split or in the loop) earlier, participants subsequently reported that they needed to slow down earlier.

The speed response questions examined other aspects of sign placement and sign combinations or sequence; these included adding an additional sign near the gore, adding the Advisory Speed plaque to the Exit Gore sign, and the use of various signing approaches in the downstream loop location. The addition of a sign (either an Advisory Speed sign, Combination Horizontal Alignment/Advisory Speed sign, or a Warning sign with Advisory Speed plaque) had some mixed results, but generally resulted in lower reported speeds (regardless of sign type). Adding an Advisory Speed plaque to the bottom of the Exit Gore sign resulted in statistically significant changes in reported speeds in both directions. Additional research would be required to determine if other variables (e.g., other signs in the series) influence the effectiveness of the Advisory Speed plaque. Finally, several sign alternatives were tested in the downstream loop location: double Turn warning signs, double Truck Rollover warning signs, Large Arrow sign, and chevrons only. Reported speeds were higher when using chevrons only compared to all other sign types tested

in the downstream loop location. Some results suggested that double warning signs may lead to lower reported speeds than the Large Arrow, and chevrons used in conjunction with the Large Arrow may lead to lower reported speeds as compared to the chevrons alone or Large Arrow alone.

Effects of Sign Elements on Perceived Severity and Likelihood of Compliance

The laboratory study examined two additional research questions: 1) What, if any, sign elements influence participant expectations regarding the severity of the curve in the exit/ramp? and 2) What, if any, sign elements influence participant likelihood of compliance with the advisory speed? These research questions were addressed through the subjective ratings, and some additional information on perceived severity was also gathered through the video simulations and open-ended questions.

The subjective ratings did vary significantly by advisory speed in that lower advisory speeds resulted in ratings of greater perceived severity and higher reported compliance. The ratings, however, did not vary significantly by wording. These findings are potentially related to the difference video findings, which showed that, regardless of sign type, participants were more likely to notice a difference in the advisory speeds shown on signs than they were to notice a difference in wording on the signs.

The ratings also varied significantly by horizontal alignment, with the Turn arrow being rated as most severe, with higher reported compliance. Furthermore, as perceived severity increased, reported compliance with the advisory speed also increased. This suggests that drivers realized they may need to drive more slowly if a curve is more severe. This positive correlation between perceived severity and reported speed also presents itself in some of the other findings. For example, the findings from the video simulations and open-ended questions support the severity ratings in that participants were more likely to expect a sharp curve at the downstream loop location when viewing the Turn Warning signs or Truck Rollover Warning signs as compared to the Large Arrow sign; this finding could explain why some of the Speed Response results suggested that double warning signs lead to lower reported speeds than the Large Arrow. On the contrary, this difference may have also been dependent on the sequence of signs. For example, participants reported speeds slightly lower with double turn warning signs in the downstream loop location than with the Large Arrow in scenarios where there was a staggered advisory speed reduction along the deceleration lane. However, this difference was not seen in other scenarios where the limiting advisory speed was signed from the beginning of the deceleration lane; this was presumably because participants reported that they would have already slowed down earlier along the deceleration lane, making the difference due to the downstream loop signing less prevalent.

FIELD STUDY

Method

The field study evaluated driver behavior in response to variations in advisory speed signing approaches. The research team collected data at seven different sites across two States: Maryland and New Hampshire. Like the laboratory study, the field study exit ramp locations were exits with a downstream split or loop ramps with downstream tightening of the loop (where available). The research team coordinated with the participating States to identify sites that were more likely to have less familiar traffic, such as those near airports or tourist attractions. Table 14 provides information about each field study site.

The research team considered the existing signing at each site and used the findings of the laboratory study to identify appropriate alternative signing approaches to evaluate at each test site. There were two to three data collection periods at each site: the baseline period (which

included the existing signs that were present at each site), and up to two additional data collection periods in which alternative signing conditions were installed at each site. Although more data were collected, the research team used data from three consecutive days (i.e., three 24 h periods on Tuesday, Wednesday, and Thursday) for each data collection period. Radar based sensors were used for collecting vehicle speed data at strategic locations throughout each exit ramp and deceleration lane, and the placement of the radar devices was consistent for all data collection periods within a given site.

Figure 13 through figure 19 depict the signing conditions for each site. Signs with no asterisk next to them represent signs that were already in place from the previous signing alternative, including the baseline, whereas signs with an asterisk represent new signs or plaques that were installed, changed, or relocated for a given signing alternative. The circles represent the relative locations of the radar collection devices.

Table 14. Description of field study sites.

| State | Site Name | Ramp Type | Regulatory Speed (mph) | Advisory Speed (mph) | Posted Speed Differential (mph) |
|---------------|-----------|-----------|------------------------|----------------------|---------------------------------|
| Maryland | MD-1 | Split | 65 | 50 | 15 |
| Maryland | MD-2 | Split | 65 | 40 | 25 |
| Maryland | MD-3 | Loop | 60 | 25 | 35 |
| New Hampshire | NH-1 | Loop | 65 | 25 | 40 |
| New Hampshire | NH-2 | Loop | 55 | 20 | 35 |
| New Hampshire | NH-3 | Loop | 55 | 25 | 30 |
| New Hampshire | NH-4 | Loop | 70* | 25 | 45 |

Figure 13. Illustration. Signing treatments for MD-1 site.

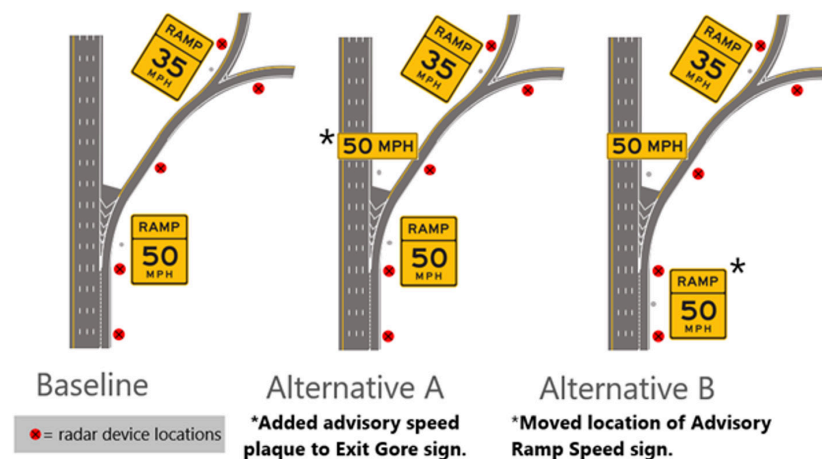
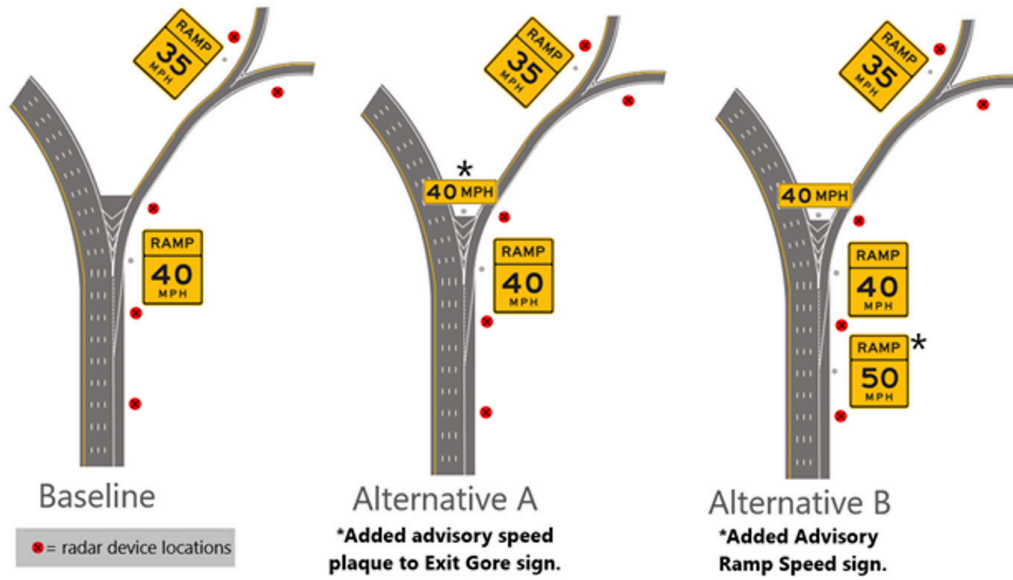
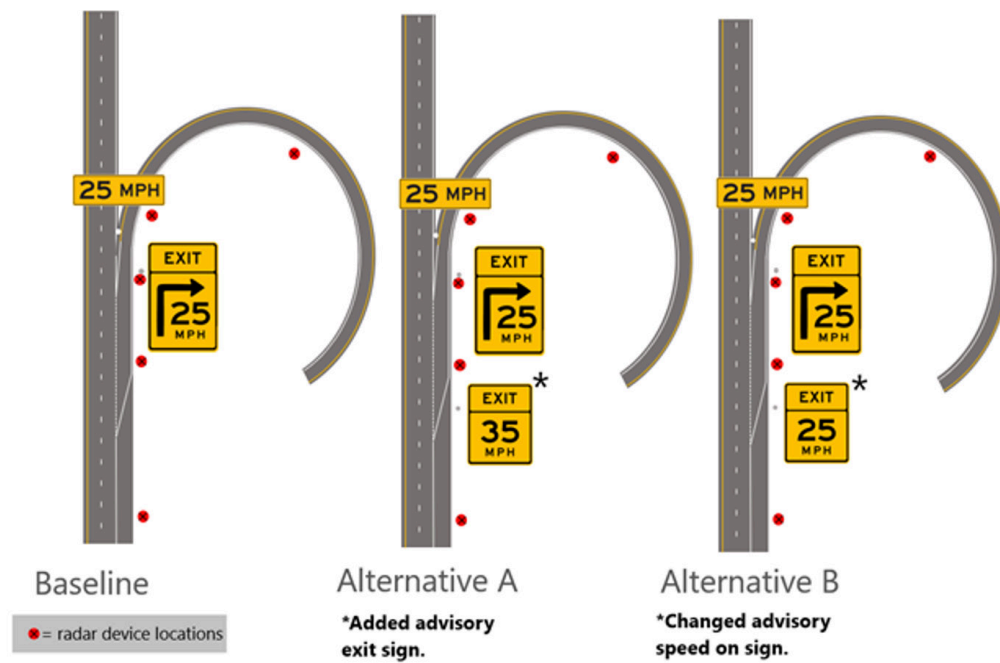

Figure 14. Illustration. Signing treatments for MD-2 site.



Source: FHWA.

Figure 15. Illustration. Signing treatments for MD-3 site.



Source: FHWA.

Figure 16. Illustration. Signing conditions for NH-1 site.

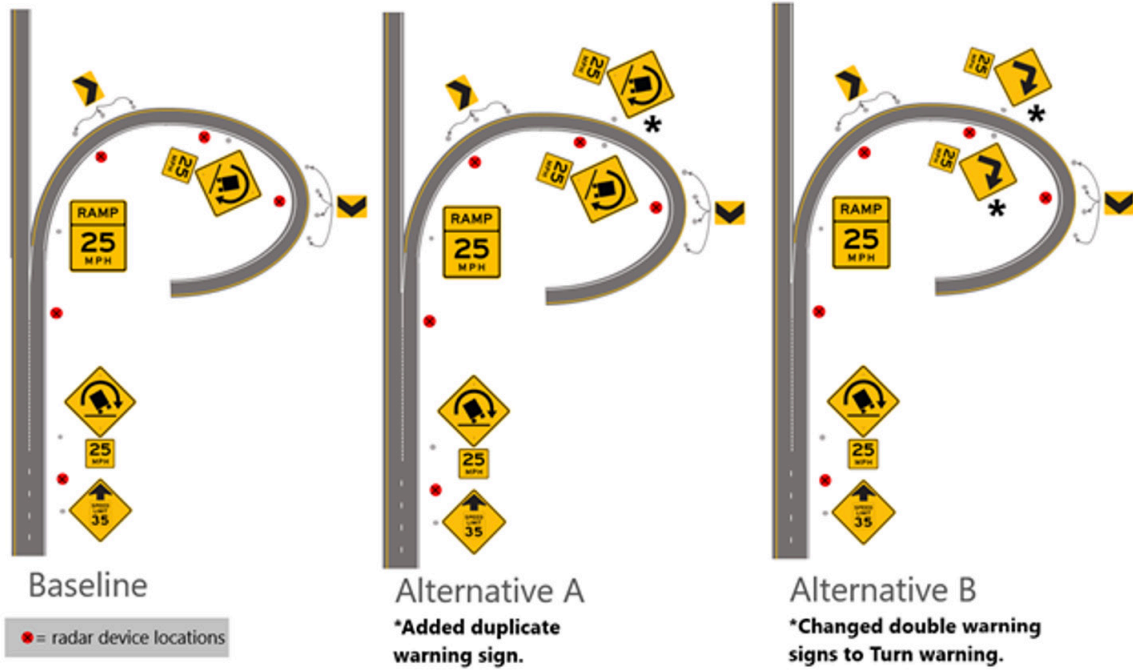

Source: FHWA.

Figure 17. Illustration. Signing conditions for NH-2 site.

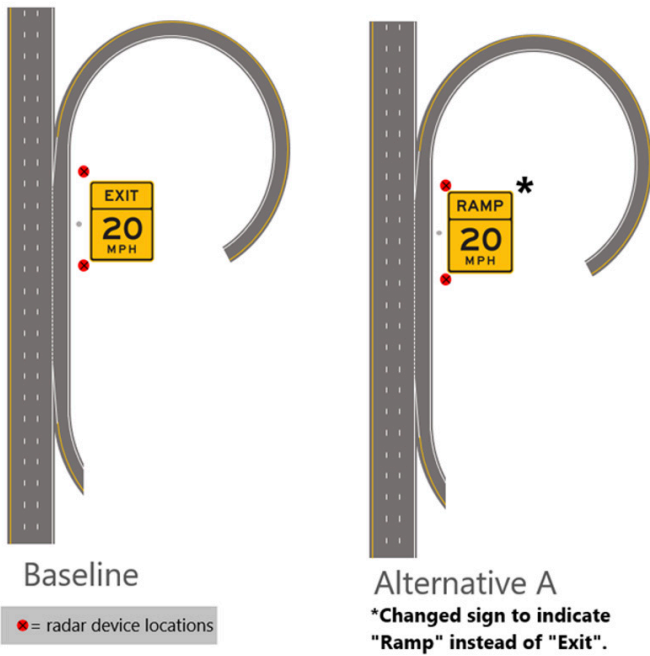

Source: FHWA.

Figure 18. Illustration. Signing conditions for NH-3 site.

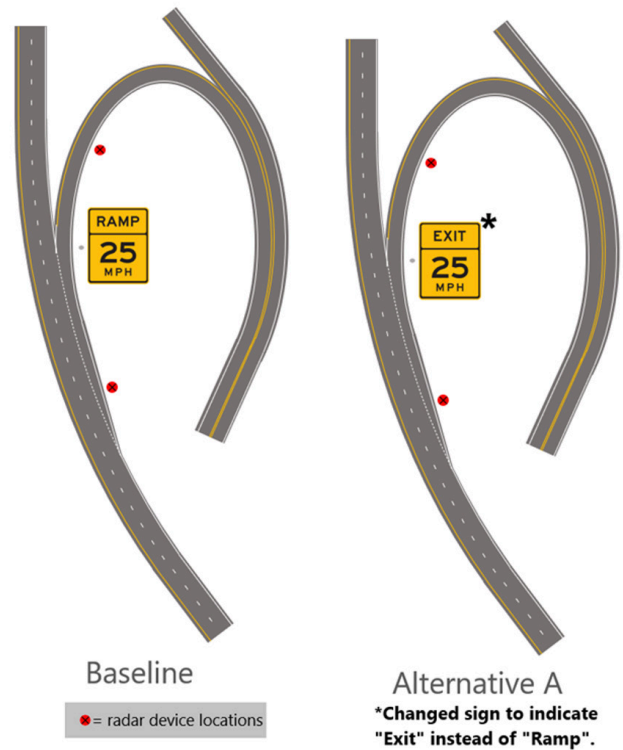

Source: FHWA.

Figure 19. Illustration. Signing conditions for NH-4 site.

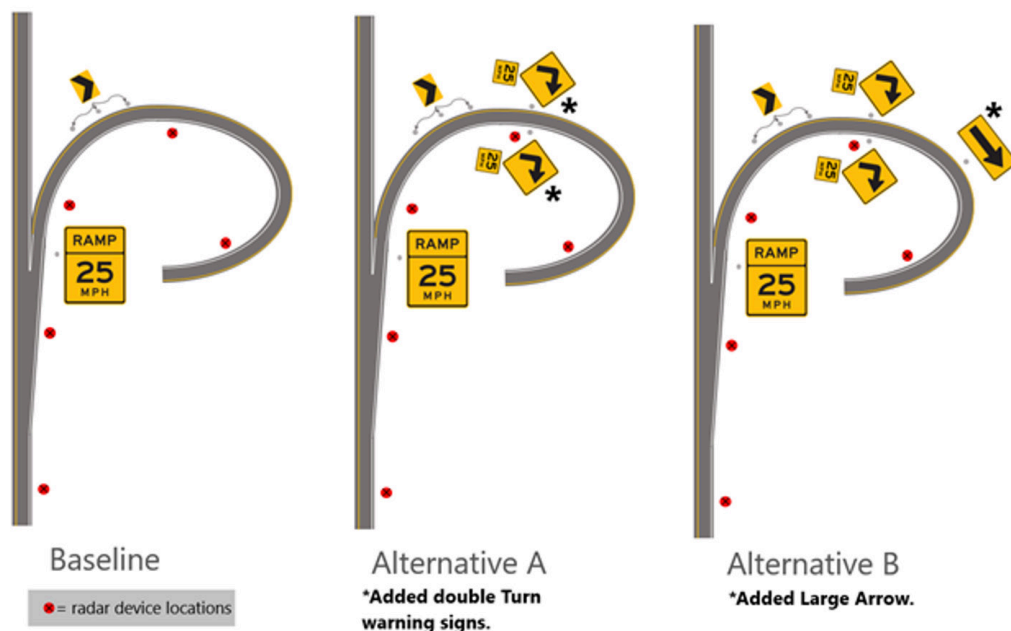

Source: FHWA.

Data Analysis

The radar detectors recorded individual vehicle speeds with timestamps. These speed data and radar location information served as the foundation of the analysis. The research team considered various observed environmental factors and modified the raw data in several ways to enhance the analysis. Local, hourly rainfall totals were identified and incorporated into the dataset, as were local daylight times, accurate to the minute. Hourly volumes were scaled by site to represent standard deviations from the mean (i.e., values greater than zero correspond to higher than average volumes). A “peak” variable was generated to capture morning (7–10 a.m.) and evening (4–7 p.m.) peak hours.

The research team also adjusted the data for vehicle platoons. Platoons consist of a platoon leader and several following vehicles; the following vehicles did not select their speeds but rather inherited them from the platoon leader. This effectively duplicates the speeds of the platoon members, which were lowered by the platoon leader rather than the signing. Platoons were identified as vehicles following within 5 s of a lead vehicle; all such vehicles except for the leader were removed from further analysis. The 5-s gap was selected as a conservative threshold to exclude platooned vehicles lacking the headway to freely select their own speed. This step excluded 1,690,836 (63 percent) of the 2,679,304 vehicle speeds recorded across all sites and radar detectors.

The radar detectors were numbered incrementally such that the first radar (i.e., farthest upstream location) at

a given site was labeled radar 1, the next successive radar was radar 2, and so on, so the highest radar number (e.g., radar 5) was used for the radar placed the farthest downstream into the exit ramp. Radar 1 at most sites (all except NH-2 and NH-3) was positioned prior to relevant signing and positioned to capture mainline speeds (i.e., not just exiting traffic). Speeds at these locations should not be affected by the signing treatments and can thus be considered controls. This allows for two analytical approaches: 1) estimating the change in speed at each radar location for each signing treatment compared to pretreatment (i.e., baseline signing), and 2) estimating the difference in those speed deltas relative to the delta at radar 1. Approach 1 can determine changes in speeds, but the change in speed compared to any change in the control (approach 2) represents a more valid measure of the effects of the treatments. Approach 2 is commonly referred to as the difference-in-differences (or diff-in-diffs) method.

Individual vehicle speeds were estimated with linear regression models to control for variables that could have influenced vehicle speeds. These models estimated individual vehicle speeds using treatment and radar location as the primary variables of interest, while also accounting for volume (scaled, squared, and cubed to account for the nonlinear relationship between volume and speed), daylight (yes or no), peak times (7–10 a.m., 4–7 p.m., neither), and rainfall (hourly, in inches). An interaction term allowed for different effects of the signs at each radar location.

Results

After adjusting for platoons, the resulting dataset included 988,468 vehicle speeds across all sites and radar detectors. Technical issues impeded data collection at three radar locations: MD-1 radar 2, and MD-2 radars 2 and 3. This prevented the analysis at these specific locations. However, each signing alternative was tested at each site.

Figure 20 through figure 22 provide the speed profiles for the three Maryland sites. Figure 23 through figure 26 provide the speed profiles for the four New Hampshire sites. All speed profiles exclude speed measurements associated with platoons. Each successive radar detector was positioned further and further into the exit ramp. Mean speeds followed a predictable decrease.

Figure 20. Graphs. Speed profiles, MD-1: Mean speed (mph) \pm 1 standard deviation by radar location and alternative.

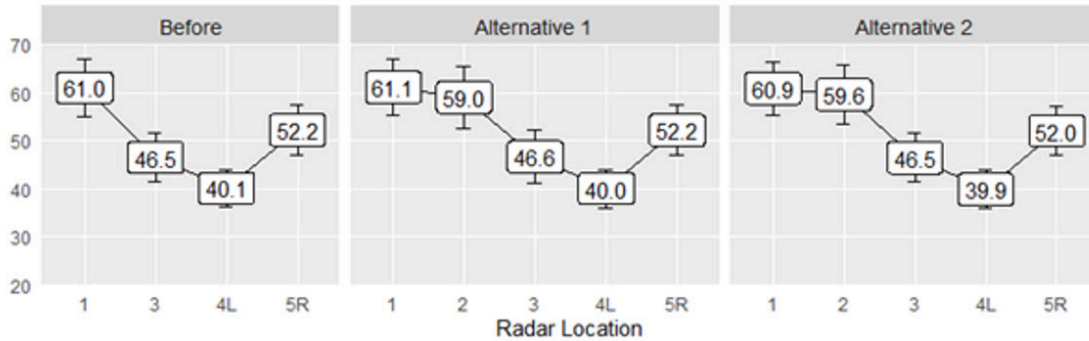

Source: FHWA.

Note: "4L" represents the left leg of the split and "5R" represents the right leg of the split.

Figure 21. Graphs. Speed profiles, MD-2: mean speed (mph) \pm 1 standard deviation by radar location and alternative.

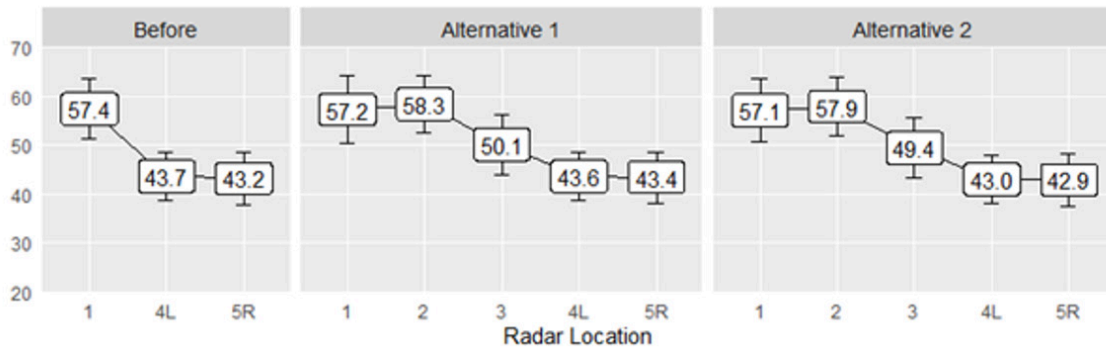

Source: FHWA.

Note: "4L" represents the left leg of the split and "5R" represents the right leg of the split.

Figure 22. Graphs. Speed profiles, MD-3: mean speed (mph) \pm 1 standard deviation by radar location and alternative.

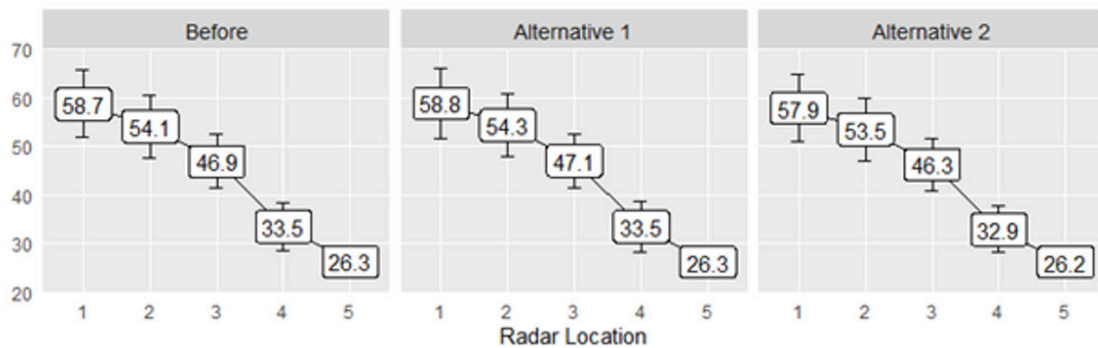

Source: FHWA.

Figure 23. Graphs. Speed profiles, NH-1: mean speed (mph) \pm 1 standard deviation by radar location and alternative.

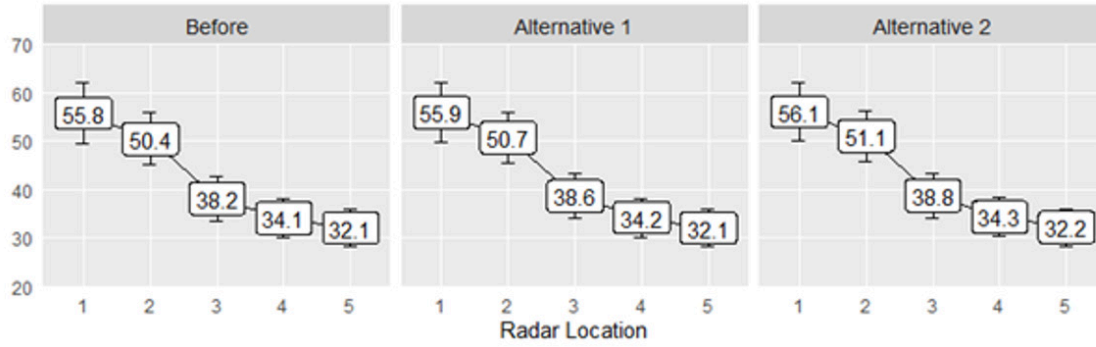

Source: FHWA.

Figure 24. Graphs. Speed profiles, NH-2: mean speed (mph) \pm 1 standard deviation by radar location and alternative.

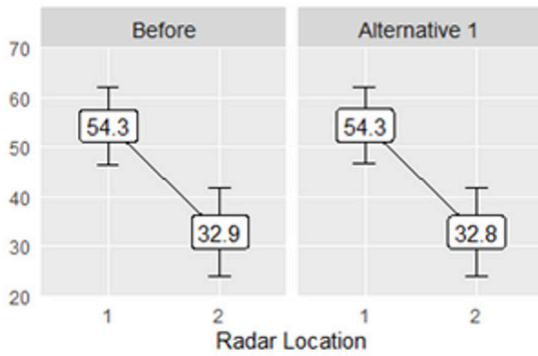

Source: FHWA.

Figure 25. Graphs. Speed profiles, NH-3: mean speed (mph) \pm 1 standard deviation by radar location and alternative.

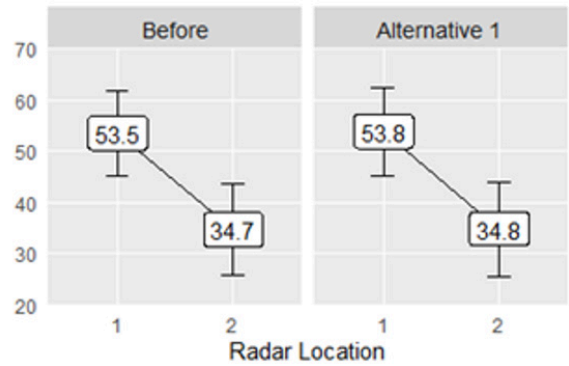

Source: FHWA.

Figure 26. Graphs. Speed profiles, NH-4: mean speed (mph) \pm 1 standard deviation by radar location and alternative.

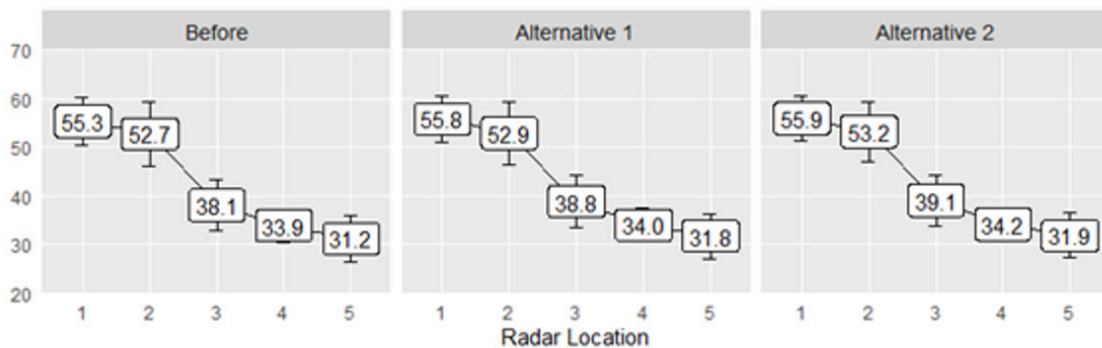

Source: FHWA.

Table 15 presents the estimated relative change in mean speeds at each radar detector. These values represent the change in speeds at each radar detector relative to the change at radar 1, with two exceptions: radar 1 at NH-2 and NH-3 cannot serve as a control because signs were visible; for these two sites, the values in table 15 represent the absolute change in mean vehicle speed. Results from seven models are shown, with each model corresponding to a site and assessing both treatments. That is, one model estimated the change in speeds under both signing alternatives for a given site. There was a statistically significant increase in speeds at seven radars (maximum increase: 0.68 mph) and decrease at three (maximum decrease: -0.39 mph).

All other explanatory variables (volume, peak, daylight, rainfall) were statistically significant, with varying effects at each site. Adjusted R² values (range: 0.545 to 0.833) and other model diagnostics indicate well-fitting models.

It should be noted that the large number of observations (range: 67,906 to 248,873) can identify statistically significant effects that may be too small to be practically significant. None of the treatments were associated with a change in speeds greater than 0.68 mph and, therefore, were not considered to be practically significant. The same analysis was conducted without adjusting for platoons and the results were similar.

Table 15. Estimated relative change in mean speeds (mph) attributable to sign treatments.

| State | Site | Condition | Radar 2 | Radar 3 | Radar 4 | Radar 5 |
|-------|-------|---------------|---------|---------|---------|---------|
| MD | MD-2 | Alternative 1 | — | — | 0.09 | 0.45* |
| MD | MD-2 | Alternative 2 | — | — | -0.36* | -0.04 |
| MD | MD-3 | Alternative 1 | 0.09 | -0.09 | -0.11 | -0.19 |
| MD | MD-3 | Alternative 2 | 0.22 | 0.23 | 0.2 | 0.68* |
| MD | MD-1 | Alternative 1 | — | 0.02 | -0.12 | -0.14 |
| MD | MD-1 | Alternative 2 | — | 0.09 | -0.08 | -0.09 |
| NH | NH-1 | Alternative 1 | 0.12 | 0.33* | -0.01 | -0.12 |
| NH | NH-1 | Alternative 2 | 0.32* | 0.29* | -0.05 | -0.15 |
| NH | NH-2† | Alternative 1 | -0.13 | — | — | — |
| NH | NH-3† | Alternative 1 | 0.44* | — | — | — |
| NH | NH-4 | Alternative 1 | -0.15 | 0.28* | -0.39* | 0.08 |
| NH | NH-4 | Alternative 2 | 0.04 | 0.43* | -0.33* | 0.08 |

*Statistically significant differences (family-wise error-rate<0.05).

†Absolute change in mean speeds (irrespective of change at radar 1).

—No data.

DISCUSSION

The speed profiles (see figure 20 through figure 26) suggest that, between the geometric changes and the signing at each site, drivers do reduce their speeds when navigating ramps. However, the speed profiles changed similarly within each site regardless of the signing alternatives that were tested. Although there were several statistically significant changes in mean speed based on signing alternatives, as indicated in table 15, these changes are not practically significant as mean speeds only changed by a range of 0.01 mph to 0.68 mph.

A closer examination of the speed profiles may provide further insight into driver behavior. Drivers tended to drive at speeds higher than the signed advisory speed for the entire ramp. For example, MD-2 provided a 40-mph advisory speed at the gore and a 35-mph advisory speed at the split; however, mean speeds across all signing treatments remained above 40 mph at all radar locations. Similar behaviors were also seen at MD-3. Similar trends occur in New Hampshire as in Maryland. NH-2, NH-3, and NH-4 all signed for 25-mph or 20-mph advisory speeds; however, none of the mean speeds at these three sites were below 30 mph at any point.

NH-1 was unique in that all three signing conditions evaluated (baseline, alternative 1, and alternative 2) included three different signs along the deceleration lane in addition to the signs posted within the loop. A 35-mph advisory speed was signed at the beginning of the deceleration lane, followed by a 25-mph advisory speed along the deceleration lane and another 25-mph advisory speed near the gore. However, mean speeds never dropped below 32 mph despite the 25-mph advisory speed being signed several times.

These findings are contrary to the laboratory results, which suggested that the farther in advance that you sign for the advisory speed along the deceleration lane, or if you sign for the limiting speed farther in advance, then motorists think they need to be slowing down earlier. Therefore, although reported speeds from the laboratory study seemed reactive to the advisory speeds near the locations of the signs, mean speeds from the field study suggest that drivers may be driving the speed that they feel comfortable and not reducing speed until they feel the need to do so, regardless of the signing conditions that were evaluated in the study.

The baseline signing conditions and signing alternatives tested in the field study consisted of relatively small variations of common signing practices. Therefore, these findings suggest that, for the sites included in this study, changing from one acceptable practice to another did not lead to any practical differences in vehicle speeds.

There are some potential limitations of the study to consider. First, the research team did not use a ball-bank indicator or other engineering practice to verify that the advisory speeds at the field sites were appropriate. Although the research team had no reason to believe that the advisory speeds were not appropriate for the test sites, if any of the advisory speeds were set too low, it is possible that this could have influenced the results. Second, the research team did not seek out sites that had a reported speeding problem. It is possible that some of the signing alternatives evaluated in the field study would have more practically significant results if applied in locations where there was a recorded speeding problem. Third, this study focused on two specific geometric configurations; results may vary at sites with different characteristics. Finally, the research team conducted the field study in different States than the laboratory study, and, therefore, it is possible that the different populations could have contributed to some of the inconsistencies in findings between the laboratory study and the field study.

CONCLUSIONS

The objective of this project was to evaluate and produce uniform recommendations for Advisory Exit and Ramp Speed signs (W13-2 and W13-3) and Combination Horizontal Alignment/Advisory Exit and Ramp Speed signs (W13-6 and W13-7), including basis for speed designation, use of “Exit” versus “Ramp,” effects of sign placement, and optimization of sign sequence.² The research team used a three-phase approach, which included a literature and state-of-practice review, a laboratory comprehension study, and a field study. Additional signs, such as Horizontal Alignment Warning signs with Advisory Speed plaques, that are commonly used in conjunction with Advisory Exit and Ramp Speed signs were also evaluated. The following summarizes the research team’s conclusions regarding the four categories of evaluation.

Basis for Speed Designation

The literature and state-of-practice review suggested that most States are using standard practices that involve using a ball-bank indicator or accelerometer to determine advisory speeds. It is likely that other factors are also considered, such as the required sight distance or surface characteristics for the ramp.

Use of “Exit” versus “Ramp”

The state-of-practice review indicated a variety in how States use “Exit” and “Ramp,” and the participants in the laboratory study provided a wide variety in the difference between “Exit” and “Ramp.” Ultimately, the findings of the present study suggest that drivers are not likely to respond differently to or notice the difference between signs based on the use of “Exit” versus “Ramp” wording on the signs. For uniformity, it may make sense to standardize which term should be used; however, the research indicates that the term chosen is not likely to impact driver comprehension or behavior.

Effects of Sign Placement

The laboratory findings suggested that, in most cases, the earlier the advisory speed sign was placed on the deceleration lane, the earlier participants tended to think they needed to slow down. In practice, based on the field results, drivers do not slow down significantly until approaching the curve itself. Therefore, it may be more appropriate to place signs with advisory speeds at locations where drivers need to begin slowing down than a location significantly upstream where drivers would not yet be required to slow down to safely navigate the curve.

² This project was initiated under the 2009 MUTCD. The 11th Edition of the MUTCD was issued prior to the publication of this technical brief.

Optimization of Sign Sequence

Based on the laboratory study and field study, standard practices that are consistent with the 2009 MUTCD seem to be effective when analyzing driver comprehension as well as driver behavior in the field. In addition to standard Exit and Ramp Speed signs, the laboratory test indicates that duplicate turn warning signs (one on each side of the ramp), double truck rollover warning signs, and Large Arrow signs are more effective than using chevrons only. Some laboratory results suggested that double warning signs may lead to lower reported speeds than the Large Arrow, though these results varied depending on the sequence of signs. Although the results were mixed, the laboratory study showed that adding an additional sign near the gore typically resulted in lower reported speeds regardless of what type of sign (Advisory Speed sign, Combination Horizontal Alignment/Advisory Speed sign, or a Warning sign with an Advisory Speed plaque) was added.

REFERENCES

FHWA. 2009. *Manual on Uniform Traffic Control Devices for Streets and Highways*, 2009 Edition. Washington, DC: Federal Highway Administration.

Ismail, A., A. Aram, R. Aminzadeh, and R. A. Rahmat. 2011. “Crashes and Effective Safety Factors Within Interchanges and Ramps on Urban Freeways and Highways.” *Australian Journal of Basic and Applied Sciences* 5, no. 7: 397–404.

Katz, B. J., S. O. Kuznicki, N. Kehoe, and J. Shurbutt. 2018. “Field Study of Driver Exiting Behavior at Complex Interchanges.” *Transportation Research Record: Journal of the Transportation Research Board* 2672, no. 37.

Lee, C., and M. Abdel-Aty. 2009. “Analysis of Crashes on Freeway Ramps by Location of Crash and Presence of Advisory Speed Signs.” *Journal of Transportation Safety & Security* 1, no. 2: 121–134. <https://doi.org/10.1080/19439960902735329>, last accessed April 1, 2024.

Lyles, R. W., and W. C. Taylor. 2006. *Communicating Changes in Horizontal Alignment*. National Cooperative Highway Research Program Report 559. Washington, DC: Transportation Research Board.

McCart, A. T., V. S. Northrup, and R. A. Retting. 2004. “Types and Characteristics of Ramp-Related Motor Vehicle Crashes on Urban Interstate Roadways in Northern Virginia.” *Journal of Safety Research* 35, no. 1: 107–114.

Voigt, A. P., C. R. Stevens, and D. W. Borchardt. 2008. “Dual-Advisory Speed Signing on Freeway-to-Freeway Connectors in Texas.” *Transportation Research Record: Journal of the Transportation Research Board* 2056, no. 1: 87–94.

Researchers—This study was conducted by Bryan Katz (ORCID: 0000-0003-2813-8098), Erin Kissner (0009-0000-4507-0115), Erin Filler (0009-0006-7786-0318), and Steve Jackson (0000-0002-3337-7846) of Xcel as part of VHB’s contract DTFH6116D00040.

Distribution—This TechBrief is being distributed according to a standard distribution. Direct distribution is being made to FHWA division offices and the Resource Center.

Availability—This TechBrief may be obtained at <https://highways.dot.gov/research>.

Key Words—Signs, advisory speed signs, advisory exit speed sign, advisory ramp speed signs, warning signs, laboratory study, field study, comprehension, data collection

Notice—This document is disseminated under the sponsorship of the U.S. Department of Transportation (USDOT) in the interest of information exchange. The U.S. Government assumes no liability for the use of the information contained in this document.

Non-Binding Contents—Except for the statutes and regulations cited, the contents of this document do not have the force and effect of law and are not meant to bind the States or the public in any way. This document is intended only to provide information regarding existing requirements under the law or agency policies.

Quality Assurance Statement—The Federal Highway Administration (FHWA) provides high-quality information to serve Government, industry, and the public in a manner that promotes public understanding. Standards and policies are used to ensure and maximize the quality, objectivity, utility, and integrity of its information. FHWA periodically reviews quality issues and adjusts its programs and processes to ensure continuous quality improvement.

Disclaimer for Product Names and Manufacturers—The U.S. Government does not endorse products or manufacturers. Trademarks or manufacturers’ names appear in this document only because they are considered essential to the objective of the document. They are included for informational purposes only and are not intended to reflect a preference, approval, or endorsement of any one product or entity.