



U.S. Department
of Transportation

**Federal Highway
Administration**

1200 New Jersey Ave., SE
Washington, D.C. 20590

In Reply Refer To:
HSST-1/CC-131

SEP 21 2016

Mr. Felipe Almanza
TraFFix Devices Inc.
160 Avenida La Pata
San Clemente, CA 92672.

Dear Mr. Almanza:

This letter is in response to your May 24, 2016 request for the Federal Highway Administration (FHWA) to review a roadside safety device, hardware, or system for eligibility for reimbursement under the Federal-aid highway program. This FHWA letter of eligibility is assigned FHWA control number CC-131 and is valid until a subsequent letter is issued by FHWA that expressly references this device.

Decision

The following devices are eligible, with details provided in the form which is attached as an integral part of this letter:

- MASH Sentry Longitudinal Energy Dissipater (SLED)

Scope of this Letter

To be found eligible for Federal-aid funding, new roadside safety devices should meet the crash test and evaluation criteria contained in the American Association of State Highway and Transportation Officials' Manual for Assessing Safety Hardware (MASH). However, the FHWA, the Department of Transportation, and the United States Government do not regulate the manufacture of roadside safety devices. Eligibility for reimbursement under the Federal-aid highway program does not establish approval, certification or endorsement of the device for any particular purpose or use.

This letter is not a determination by the FHWA, the Department of Transportation, or the United States Government that a vehicle crash involving the device will result in any particular outcome, nor is it a guarantee of the in-service performance of this device. Proper manufacturing, installation, and maintenance are required in order for this device to function as tested.

This finding of eligibility is limited to the crashworthiness of the system and does not cover other structural features, nor conformity with the Manual on Uniform Traffic Control Devices.

Eligibility for Reimbursement

Based solely on a review of crash test results and certifications submitted by the manufacturer, and the crash test laboratory, FHWA agrees that the device described herein meets the crash test and evaluation criteria of the American Association of State Highway and Transportation Officials' Manual for Assessing Safety Hardware (MASH). Therefore, the device is eligible for reimbursement under the Federal-aid highway program if installed under the range of tested conditions.

Name of system: MASH Sentry Longitudinal Energy Dissipater (SLED)

Type of system: Crash Cushion

Test Level: MASH Test Level 3

Testing conducted by: KARCO

Date of request: May 24, 2016

Date initially acknowledged: May 27, 2016

Date of completed package: August 15, 2016

FHWA concurs with the recommendation of the accredited crash testing laboratory as stated within the attached form.

Full Description of the Eligible Device

The device and supporting documentation, including reports of the crash tests or other testing done, videos of any crash testing, and/or drawings of the device, are described in the attached form.

Notice

If a manufacturer makes any modification to any of their roadside safety hardware that has an existing eligibility letter from FHWA, the manufacturer must notify FHWA of such modification with a request for continued eligibility for reimbursement. The notice of all modifications to a device must be accompanied by:

- Significant modifications – For these modifications, crash test results must be submitted with accompanying documentation and videos.
- Non-signification modifications – For these modifications, a statement from the crash test laboratory on the potential effect of the modification on the ability of the device to meet the relevant crash test criteria.

FHWA's determination of continued eligibility for the modified hardware will be based on whether the modified hardware will continue to meet the relevant crash test criteria.

You are expected to supply potential users with sufficient information on design, installation and maintenance requirements to ensure proper performance.

You are expected to certify to potential users that the hardware furnished has the same chemistry, mechanical properties, and geometry as that submitted for review, and that it will meet the test and evaluation criteria of the MASH.

Issuance of this letter does not convey property rights of any sort or any exclusive privilege. This letter is based on the premise that information and reports submitted by you are accurate and correct. We reserve the right to modify or revoke this letter if: (1) there are any inaccuracies in the information submitted in support of your request for this letter, (2) the qualification testing was flawed, (3) in-service performance or other information reveals safety problems, (4) the system is significantly different from the version that was crash tested, or (5) any other information indicates that the letter was issued in error or otherwise does not reflect full and complete information about the crashworthiness of the system.

Standard Provisions

- To prevent misunderstanding by others, this letter of eligibility designated as FHWA control number CC-131 shall not be reproduced except in full. This letter and the test documentation upon which it is based are public information. All such letters and documentation may be reviewed upon request.
- This letter shall not be construed as authorization or consent by the FHWA to use, manufacture, or sell any patented system for which the applicant is not the patent holder.
- If the subject device is a patented product it may be considered to be proprietary. If proprietary systems are specified by a highway agency for use on Federal-aid projects: (a) they must be supplied through competitive bidding with equally suitable unpatented items; (b) the highway agency must certify that they are essential for synchronization with the existing highway facilities or that no equally suitable alternative exists; or (c) they must be used for research or for a distinctive type of construction on relatively short sections of road for experimental purposes. Our regulations concerning proprietary products are contained in Title 23, Code of Federal Regulations, Section 635.411.

Sincerely yours,



Michael S. Griffith
Director, Office of Safety Technologies
Office of Safety

Enclosures

Request for Federal Aid Reimbursement Eligibility of Highway Safety Hardware

Submitter	Date of Request:	5-24-16	<input checked="" type="radio"/> New <input type="radio"/> Resubmission
	Name:	Felipe Almanza	
	Company:	Traffix Devices Inc.	
	Address:	160 Avenida La Pata San Clemente California 92672	
	Country:	United States	
	To:	Michael S. Griffith, Director FHWA, Office of Safety Technologies	

I request the following devices be considered eligible for reimbursement under the Federal-aid highway program.

Device & Testing Criterion - Enter from right to left starting with Test Level

1-1-1

System Type	Submission Type	Device Name / Variant	Testing Criterion	Test Level
'CC': Crash Cushions, Attenuators, & Terminals	<input checked="" type="radio"/> Physical Crash Testing <input type="radio"/> Engineering Analysis	SLED	AASHTO MASH	TL3

By submitting this request for review and evaluation by the Federal Highway Administration, I certify that the product(s) was (were) tested in conformity with the AASHTO Manual for Assessing Safety Hardware and that the evaluation results meet the appropriate evaluation criteria in the MASH.

Individual or Organization responsible for the product:

Contact Name:	Felipe Almanza	Same as Submitter <input checked="" type="checkbox"/>
Company Name:	Traffix Devices Inc.	Same as Submitter <input checked="" type="checkbox"/>
Address:	160 Avenida La Pata San Clemente California 92672	Same as Submitter <input checked="" type="checkbox"/>
Country:	United States	Same as Submitter <input checked="" type="checkbox"/>

Enter below all disclosures of financial interests as required by the FHWA 'Federal-Aid Reimbursement Eligibility Process for Safety Hardware Devices' document.

Traffix Devices Inc. and Karco Engineering LLC share no financial interests between the two organizations. This includes no shared financial interest but not limited to:

- i. Compensation included wages, salaries, commissions, professional fees, or fees for business referrals
- iii. Research funding or other forms of research support;
- iv. Patents, copyrights, licenses, and other intellectual property interests;
- vi. Business ownership and investment interests;

PRODUCT DESCRIPTION

New Hardware or Significant Modification
 Modification to Existing Hardware

The SLED is a non-redirective, gating crash cushion, designed to shield the end of rigid objects. The SLED is free standing, does not require anchoring to the road surface, can be used on concrete, asphalt, gravel, and compacted dirt surfaces. The surface used for these tests was concrete. A SLED transition is mechanically attached to the barrier it is shielding. Freestanding barrier was used for this test series. The system consists of six main components: four Modules, one Containment Impact Sled (CIS), and one transition. The system's overall dim. are 25.25 ft (7.7 m) long (pin to pin) X 2.3 ft (0.7 m) wide X 3.8 ft (1.2 m) tall. The modules have overall dim. of 6.3 ft (1.9 m) long (pin to pin) X 1.9 ft (0.57 m) wide X 3.8 ft (1.2 m) tall. The modules are manufactured from polyethylene that is UV stabilized. A TL-3 system consists of three water filled modules and one empty front module connected to the steel CIS. Water filled modules weigh approx. 2000lbs (907 kg) when filled. Each water filled module contains a fill lid, which incorporates a pop up float water level indicator for identifying that modules are filled to the appropriate level. Permanently molded within the plastic modules are four corrosion resistant cables. The modules are designed with knuckles at the ends which contains a series of vertically aligned concentric holes that allow a steel t-pin to be inserted to connect adjacent modules together. When modules are pinned together there are a total of eleven knuckles aligned with the steel t-pin inserted. This provides a positive connection between adjacent modules. At the front of the SLED system is the steel CIS that is connected to the empty front module. The empty module is identical in design to the water filled modules. To assure that the front module in the CIS remains empty, drain holes are drilled into the module at ground level preventing water filling. The CIS is designed using a steel tube frame and sheet metal construction. The CIS has overall dim. of 2.5 ft (0.77 m) tall X 2.3 ft (0.7 m) wide X 7.3 ft (2.2 m) long, and weighs 197 lb (89.4 kg). The empty module is connected to the CIS through the vertically aligned concentric holes in the knuckles and the t-pin connects the module and the CIS together. This is the same connection method used between adjacent modules. Bolted to the front impact face on the CIS is the directional indicator panel. The directional indicator panel is a square sheet of plastic that contains gore point directional sheeting on one side and left, or right, directional sheeting on the opposite side. This allows the user to convert the panel to the proper direction when installing the SLED. The directional indicator panel contours to the curved shape on the front impact face on the CIS and is secured by six bolts. The SLED is attached to the barrier using two transition panels attached to both sides of the barriers side surfaces. The SLED Transition is made of three main components: one steel transition frame and two symmetric transition panels. The transition frame is positively connected to the rear most water filled module through the vertically aligned concentric holes in the knuckles using a steel t-pin. This is the same connection method used between adjacent modules and within the CIS and the empty front module. The transition panels are pinned to the transition frame using outboard alignment pins designed into the transition frame. The transition panels are attached to the barrier using a minimum of four mechanical fasteners per side. A minimum of eight fasteners are required to attach the SLED to the barrier. The MASH tested and passed SLED TL-3 crash cushion, described above, is the same product as the previously tested and passed NCHRP-350 SLED TL-3 crash cushion (Reference Letter CC-114). The design, manufacturing process, and installation are identical between the MASH and NCHRP-350 tested products. Existing inventory is interchangeable as no design changes have been made since the inception of the SLED in February 2011.

CRASH TESTING

By signature below, the Engineer affiliated with the testing laboratory, agrees in support of this submission that all of the critical and relevant crash tests for this device listed above were conducted to meet the MASH test criteria. The Engineer has determined that no other crash tests are necessary to determine the device meets the MASH criteria.

Engineer Name:	Balbino A. Beltran	
Engineer Signature:	Balbino A. Beltran	Digitally signed by Balbino A. Beltran DN: cn=Balbino A. Beltran, o=KARCO Engineering, LLC, ou, email=abeltran@karco.com, c=US Date: 2016.08.12 11:50:13 -0700
Address:	9270 Holly Rd. Adelanto, CA. 92301	Same as Submitter <input type="checkbox"/>
Country:	United States	Same as Submitter <input type="checkbox"/>

A brief description of each crash test and its result:

Required Test Number	Narrative Description	Evaluation Results
3-30 (1100C)	Test for redirective crash cushions is not applicable for the SLED system.	Non-Relevant Test, not conducted
3-31 (2270P)	Test for redirective crash cushions is not applicable for the SLED system.	Non-Relevant Test, not conducted
3-32 (1100C)	Test for redirective crash cushions is not applicable for the SLED system.	Non-Relevant Test, not conducted
3-33 (2270P)	Test for redirective crash cushions is not applicable for the SLED system.	Non-Relevant Test, not conducted
3-34 (1100C)	Test for redirective crash cushions is not applicable for the SLED system.	Non-Relevant Test, not conducted
3-35 (2270P)	Test for redirective crash cushions is not applicable for the SLED system.	Non-Relevant Test, not conducted
3-36 (2270P)	Test for redirective crash cushions is not applicable for the SLED system.	Non-Relevant Test, not conducted
3-37 (2270P)	Test for redirective crash cushions is not applicable for the SLED system.	Non-Relevant Test, not conducted
3-38 (1500A)	Test for redirective crash cushions is not applicable for the SLED system.	Non-Relevant Test, not conducted
3-40 (1100C)	<p>The SLED was positioned offset a quarter of the vehicle's width toward the passenger side. The offset position examines the risk of exceeding occupant risk values, vehicle instability, and vehicle yaw movement. The test was conducted using a commercially available 2010 Kia Rio 4-door sedan with a test inertial mass of 2,459.2 lbs (1,115.5 kg). The test vehicle impacted the SLED at a velocity of 63.66 mph (102.45 km/hr) and at an impact angle of 0.2°. The test vehicle impacted the Containment Impact Sled (CIS), pushing it rearward, crushing and rupturing the empty and water filled modules before rotating about its yaw axis before coming to a controlled stop. The vehicle remained upright throughout the impact event. The test vehicle's occupant compartment was not penetrated and there was no measurable in cab deformation. The maximum roll and pitch angle did not exceed 75° and occupant risk values were within limits per MASH specifications for Occupant Impact Velocity (OIV) and Ridedown Acceleration (RA).</p>	PASS

Required Test Number	Narrative Description	Evaluation Results
3-41 (2270P)	<p>The SLED was positioned inline with the center of the test vehicle. The inline centered position examines the risk of exceeding occupant risk values, vehicle instability, the SLED's capacity to absorb sufficient impact energy, and the SLED's ability to bring the vehicle to a safe controlled stop. The test was conducted using a commercially available 2012 Dodge Ram 4-door pickup truck with a test inertial mass of 4,927.2 lbs (2,235 kg). The test vehicle impacted the SLED at a velocity of 62.12 mph (100 km/hr) and at an impact angle of 0.9°. The test vehicle impacted the Containment Impact Sled (CIS) pushing it rearward crushing and rupturing the empty and water filled modules. The SLED brought the vehicle to a controlled stop, remained upright, and did not exhibit vaulting throughout the impact event. The test vehicle's occupant compartment was not penetrated and there was no measurable in cab deformation. The maximum roll and pitch angle did not exceed 75° and occupant risk values are within limits per MASH specifications for Occupant Impact Velocity and Ridedown Acceleration.</p>	PASS
3-42 (1100C)	<p>The test was conducted using a commercially available 2010 Kia Rio 4-door sedan with a test inertial mass of 2,443.8 lbs (1,108.5 kg). The test vehicle impacted the crash cushion at a velocity of 61.94 mph (99.68 km/hr) and at an impact angle of 14°. The test vehicle impacted the Containment Impact Sled (CIS) and the front empty and first water filled module were forced rearward and rotated counter-clockwise 180° from their original position. This rotation induced a large bending moment on the rear water filled modules and on the transition connection point to the barrier. The modules remained tethered together via the steel t-pin between adjacent modules which connects directly to the internal molded in steel cables inside all the modules. The transition attachment remained secure to the CMB and did not release from the barrier throughout the impact event. The test vehicle's occupant compartment was not penetrated and there were no measurable in cab deformation. The maximum roll and pitch angle did not exceed 75°. Occupant risk values are within limits per MASH specifications for Occupant Impact Velocity and Ridedown Acceleration.</p>	PASS

3-43 (2270P)	<p>The test was conducted using a commercially available 2010 Dodge Ram 4-door pickup truck with a test inertial mass of 4,917.3 lbs (2,230.5 kg). The test vehicle impacted the crash cushion at a velocity of 60.21 mph (96.90 km/hr) and at an impact angle of 15.2°. The test vehicle impacted the Containment Impact Sled (CIS) and the front empty and first water filled module were forced rearward and rotated counter-clockwise 180° from their original position. This rotation induced a large bending moment on the rear water filled modules and on the transition connection point to the barrier. The modules remained tethered together via the steel t-pin between adjacent modules which connects directly to the internal molded in steel cables inside all the modules. The transition attachment remained secure to the barrier and did not release from the barrier throughout the impact event. The test vehicle's occupant compartment was not penetrated and there were no measurable in cab deformation. The maximum roll and pitch angle did not exceed 75°. Occupant risk values are within limits per MASH specifications for Occupant Impact Velocity and Ridedown Acceleration.</p>	PASS
--------------	---	------

3-44 (2270P)	<p>The SLED was positioned at a nominal angle of 20° and the centerline of the impacting vehicle was directed at the corner of the adjoining concrete median barrier. This angle and intersection directed the test vehicle into the crash cushion at its CIP approx. 14.92 ft [4.55 m] from the front of the SLED. The CIP and impact angle was defined in specifications detailed in MASH for test procedures for Gating Non-Redirective Crash Cushion. The test was conducted using a commercially available 2009 Dodge Ram 4-door pickup truck with a test inertial mass of 4,954.7 lbs (2,247.5 kg). The test vehicle impacted the crash cushion at a velocity of 62.58 mph (100.71 km/hr) and at an impact angle of 20.5°. The test vehicle made initial contact with the second water filled module. The test vehicle subsequently impacted the third water filled modules. All four Modules and the Containment Impact Sled (CIS) rotated clockwise upon impact and the concrete median barriers were pushed forward and rotated counterclockwise. The transition attachment remained securely attached to the CMB throughout the impact event. All the modules remained tethered and restrained to each other. The steel drop pins between adjacent modules and the internal molded in steel cables remained intact preventing the vehicle from entering the clear zone. The SLED brought the vehicle to a controlled stop, the vehicle remained upright, and did not exhibit vaulting throughout the impact event. The maximum roll and pitch angle did not exceed 75°.</p>	PASS
--------------	---	------

3-45 (1500A)	The SLED was positioned inline with center of the test vehicle. The inline centered position examines the risk of exceeding occupant risk values, vehicle instability, the SLED's capacity to absorb sufficient impact energy, and the SLED's ability to bring the vehicle to a safe controlled stop. The test was conducted using a commercially available 2010 Chevy Malibu 4-door sedan with a test inertial mass of 3,310.2 lbs (1,501.5 kg). The test vehicle impacted the SLED at a velocity of 62.13 mph (99.99 km/hr) and at an impact angle of 0°. The test vehicle impacted the Containment Impact Sled (CIS) pushing it rearward crushing and rupturing the empty and water filled modules. The SLED brought the vehicle to a controlled stop and remained upright throughout the impact event. The test vehicle's occupant compartment was not penetrated and there was no measurable in cab deformation. The maximum roll and pitch angle did not exceed 75°. Occupant risk values are within limits per MASH specifications for Occupant Impact Velocity and Ridedown Acceleration.	PASS
--------------	---	------

Full Scale Crash Testing was done in compliance with MASH by the following accredited crash test laboratory (cite the laboratory's accreditation status as noted in the crash test reports.):

Laboratory Name:	KARCO Engineering, INC	
Laboratory Signature:	Balbino A. Beltran	Digitally signed by Balbino A. Beltran DN: cn=Balbino A. Beltran, o=KARCO Engineering, LLC., ou, email=abeltran@karco.com, c=US Date: 2016.08.12 11:50:37 -0700
Address:	9270 Holly Rd. Adelanto, CA. 92301	Same as Submitter <input type="checkbox"/>
Country:	United States	Same as Submitter <input type="checkbox"/>
Accreditation Certificate Number and Dates of current Accreditation period :	December 18, 2015 - December 18, 2017	

Submitter Signature*:

Felipe Almanza

Digitally signed by Felipe Almanza
DN: cn=Felipe Almanza, o=TrafFix Devices Inc., ou,
email=falmanza@traffixdevices.com, c=US
Date: 2016.08.10 17:39:15 -0700

Submit Form

ATTACHMENTS

Attach to this form:

- 1) Additional disclosures of related financial interest as indicated above.
- 2) A copy of the full test report, video, and a Test Data Summary Sheet for each test conducted in support of this request.
- 3) A drawing or drawings of the device(s) that conform to the Task Force-13 Drawing Specifications [Hardware Guide Drawing Standards]. For proprietary products, a single isometric line drawing is usually acceptable to illustrate the product, with detailed specifications, intended use, and contact information provided on the reverse. Additional drawings (not in TF-13 format) showing details that are relevant to understanding the dimensions and performance of the device should also be submitted to facilitate our review.

FHWA Official Business Only:

Eligibility Letter		
Number	Date	Key Words

SECTION 4

MASH TEST 3-41 SUMMARY

Test Article: TraFiX Devices SLED
Test Program: MASH 3-41

Project No. P35201-01
Test Date: 10/22/15

SEQUENTIAL PHOTOGRAPHS

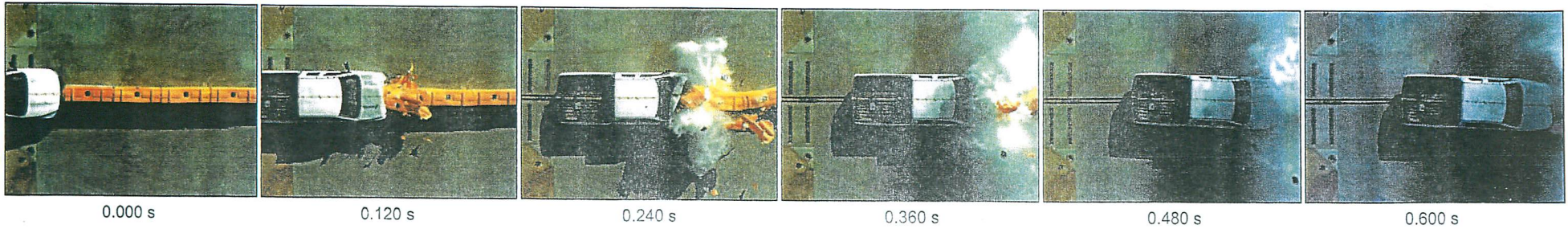

PLAN VIEW

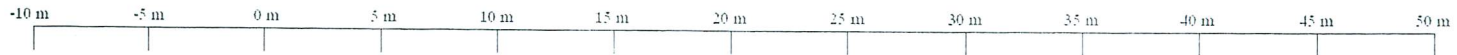

- Pre-Test Vehicle
- Post-Test Vehicle
- Pre-Test Article
- Post-Test Article
- Post-Test Debris

SECTION 4...(CONTINUED)

MASH TEST 3-41 SUMMARY

Test Article: TraFFix Devices SLED
 Test Program: MASH 3-41

Project No. P35201-01
 Test Date: 10/22/15

GENERAL INFORMATION		IMPACT AND EXIT CONDITIONS	
TEST AGENCY	KARCO Engineering, LLC.	IMPACT VELOCITY	62.12 mph (100.0 km/h)
TEST NUMBER	P35201-01	IMPACT ANGLE (°)	0.9
TEST DESIGNATION	3-41	MAXIMUM ROLL ANGLE (°)	-3.4
TEST DATE	10/22/15	MAXIMUM PITCH ANGLE (°)	2.4
TEST ARTICLE		MAXIMUM YAW ANGLE (°)	1.9
NAME / MODEL	Sentry Longitudinal Energy Dissipater (SLED)	STOPPING DISTANCE	23.7 ft. (7.2 m)
TYPE	Crash Cushion / End Treatment	IMPACT SEVERITY	643.4 kip-ft (872.4 kJ)
KEY ELEMENTS	Containment Impact Sled, Empty Primary Element, Water Filled Secondary Elements	OCCUPANT RISK VALUES	
CRASH CUSHION LENGTH	25.0 ft. (7.6 m)	OCCUPANT IMPACT VELOCITY	Longitudinal 32.5 ft/s (9.9 m/s)
ADJOINING BARRIER LENGTH	40.9 ft. (12.5 m)		Lateral 0.3 ft/s (0.1 m/s)
ROAD SURFACE	Concrete	RIDEDOWN ACCELERATION	Longitudinal -11.5 g
TEST VEHICLE			Lateral 1.5 g
TYPE / DESIGNATION	2270P	THIV	32.2 ft/s (9.8 m/s)
YEAR, MAKE AND MODEL	2012 Dodge Ram 1500	PHD	11.5 g
CURB MASS	4,988.0 lbs (2,262.5 kg)	ASI	0.93
TEST INERTIAL MASS	4,927.2 lbs (2,235.0 kg)	VEHICLE DAMAGE	
GROSS STATIC MASS	4,927.2 lbs (2,235.0 kg)	VEHICLE DAMAGE SCALE	12-FC-5
		COLLISION DAMAGE CLASSIFICATION	12FCEW3

SECTION 4

MASH TEST 3-40 SUMMARY

Test Article: TrafFix Devices SLED

Project No. P35244-01

Test Program: MASH 3-40

Test Date: 11/23/15

SEQUENTIAL PHOTOGRAPHS

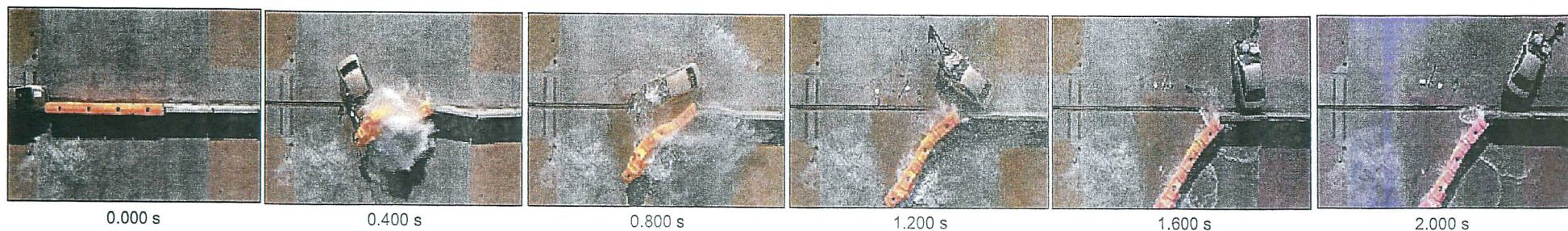

PLAN VIEW

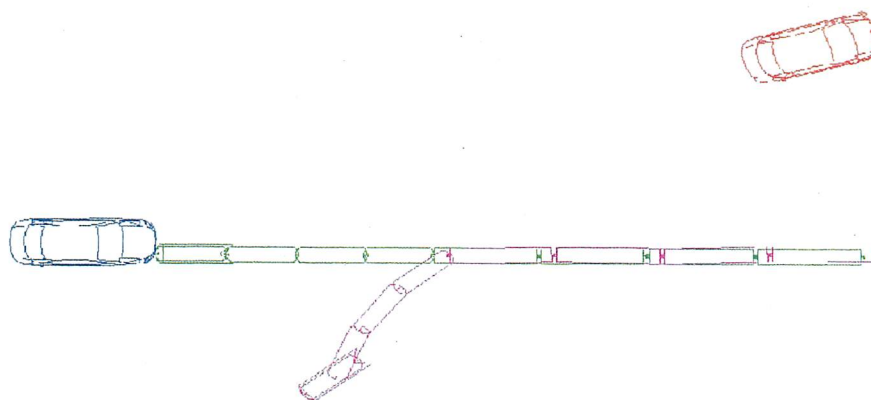
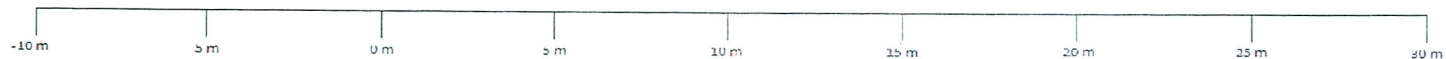

SECTION 4...(CONTINUED)

MASH TEST 3-40 SUMMARY

Test Article: TraFiX Devices SLEDProject No. P35244-01Test Program: MASH 3-40Test Date: 11/23/15

GENERAL INFORMATION		IMPACT AND EXIT CONDITIONS	
TEST AGENCY	KARCO Engineering, LLC.	IMPACT VELOCITY	63.66 mph (102.45 km/h)
TEST NUMBER	P35244-01	IMPACT ANGLE (°)	0.2
TEST DESIGNATION	3-40	MAXIMUM ROLL ANGLE (°)	6.3
TEST DATE	11/23/15	MAXIMUM PITCH ANGLE (°)	-7.5
TEST ARTICLE		MAXIMUM YAW ANGLE (°)	-327.5
NAME / MODEL	Sentry Longitudinal Energy Dissipater (SLED)	STOPPING DISTANCE	73.5 ft. (22.4 m)
TYPE	Crash Cushion / End Treatment	KINETIC ENERGY	333.2 kip-ft (451.8 kJ)
KEY ELEMENTS	Containment Impact Sled, Empty Primary Element, Water Filled Secondary Elements	OCCUPANT RISK VALUES	
CRASH CUSHION LENGTH	25.5 ft. (7.8 m)	OCCUPANT IMPACT VELOCITY	Longitudinal 33.5 ft/s (10.2 m/s)
ADJOINING BARRIER LENGTH	40.3 ft. (12.3 m)		Lateral 3.6 ft/s (1.1 m/s)
ROAD SURFACE	Concrete	RIDEDOWN ACCELERATION	Longitudinal -16.5 g
TEST VEHICLE			Lateral 6.2 g
TYPE / DESIGNATION	1100C	THIV	33.8 ft/s (10.3 m/s)
YEAR, MAKE AND MODEL	2010 Kia Rio LX	PHD	16.7 g
CURB MASS	2,456.0 lbs (1,114.0 kg)	ASI	1.06
TEST INERTIAL MASS	2,459.3 lbs (1,115.5 kg)	VEHICLE DAMAGE	
GROSS STATIC MASS	2,620.2 lbs (1,188.5 kg)	VEHICLE DAMAGE SCALE	12-FD-3
		COLLISION DAMAGE CLASSIFICATION	12FDEW2

SECTION 4

MASH TEST 3-45 SUMMARY

Test Article: TraFFix Devices SLED
Test Program: MASH 3-45

Project No. P35211-01
Test Date: 10/23/15

SEQUENTIAL PHOTOGRAPHS

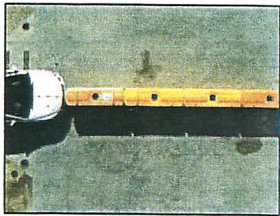

0.000 s

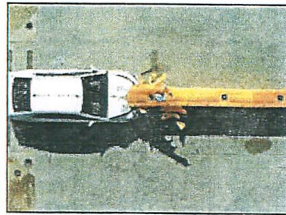

0.100 s

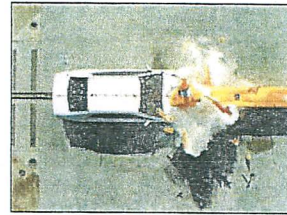

0.200 s

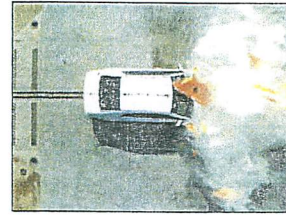

0.300 s

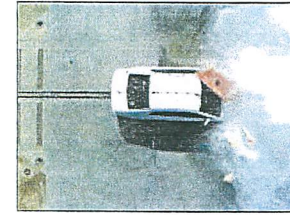

0.400 s

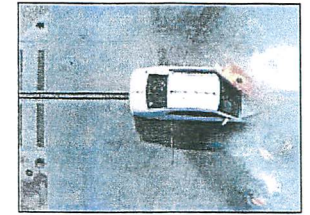

0.500 s

PLAN VIEW



- Pre-Test Article
- Vehicle
- Post-Test Article
- Vehicle
- Debris

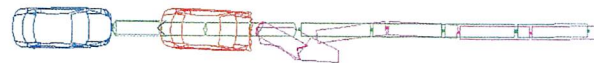

SECTION 4

MASH TEST 3-45 SUMMARY... (CONTINUED)

Test Article: TraFiX Devices SLED
 Test Program: MASH 3-45

Project No. P35211-01
 Test Date: 10/23/15

SUMMARY TABLE

GENERAL INFORMATION		IMPACT AND EXIT CONDITIONS	
TEST AGENCY	KARCO Engineering, LLC.	IMPACT VELOCITY	62.13 mph (99.99 km/h)
TEST NUMBER	P35211-01	IMPACT ANGLE (°)	0.0
TEST DESIGNATION	3-45	MAXIMUM ROLL ANGLE (°)	2.3
TEST DATE	10/23/15	MAXIMUM PITCH ANGLE (°)	2.6
TEST ARTICLE		MAXIMUM YAW ANGLE (°)	3.1
NAME / MODEL	Sentry Longitudinal Energy Dissipater (SLED)	STOPPING DISTANCE	20.3 ft. (6.2 m)
TYPE	Crash Cushion / End Treatment	IMPACT SEVERITY	427.2 kip-ft (579.1 kJ)
KEY ELEMENTS	Containment Impact Sled, Empty Primary Element, Water Filled Secondary Elements	OCCUPANT RISK VALUES	
CRASH CUSHION LENGTH	25.3 ft. (7.7 m)	OCCUPANT IMPACT VELOCITY	Longitudinal 33.8 ft/s (10.3 m/s)
ADJOINING BARRIER LENGTH	40.9 ft. (12.5 m)		Lateral 2.0 ft/s (0.6 m/s)
ROAD SURFACE	Concrete	RIDEDOWN ACCELERATION	Longitudinal -11.7 g
TEST VEHICLE			Lateral 2.0 g
TYPE / DESIGNATION	1500A	THIV	33.8 ft/s (10.3 m/s)
YEAR, MAKE AND MODEL	2010 Chevy Malibu	PHD	11.7 g
CURB MASS	3,352.1 lbs (1,520.5 kg)	ASI	1.06
TEST INERTIAL MASS	3,310.2 lbs (1,501.5 kg)	VEHICLE DAMAGE	
GROSS STATIC MASS	3,310.2 lbs (1,501.5 kg)	VEHICLE DAMAGE SCALE	12-FC-5
		COLLISION DAMAGE CLASSIFICATION	12FCEW2

SECTION 4

MASH TEST 3-44 SUMMARY

Test Article: TraFiX Devices SLED
Test Program: MASH 3-44

Project No. P35049-01
Test Date: 10/27/15

SEQUENTIAL PHOTOGRAPHS

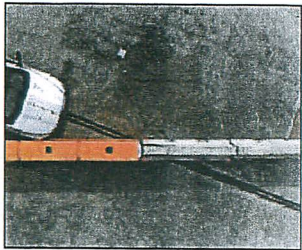

0.000 s

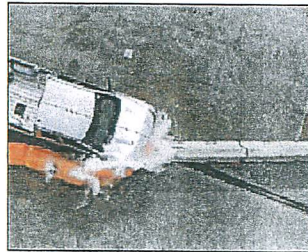

0.111 s



0.277 s

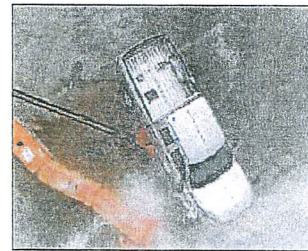

0.615 s



1.079 s

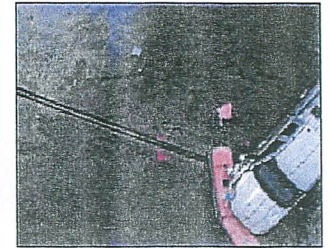

1.954 s

PLAN VIEW



- Pre-Test
 - Article (blue dot)
 - Vehicle (green dot)
- Post-Test
 - Article (light blue dot)
 - Vehicle (red dot)
 - Debris (dark red dot)

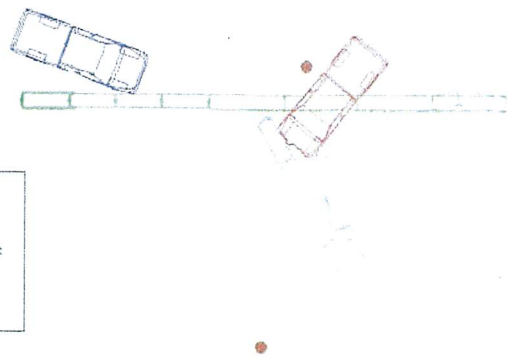

SECTION 4...(CONTINUED)

MASH TEST 3-44 SUMMARY

Test Article: TrafFix Devices SLED
 Test Program: MASH 3-44

Project No. P35049-01
 Test Date: 10/27/15

GENERAL INFORMATION		IMPACT AND EXIT CONDITIONS	
TEST AGENCY	KARCO Engineering, LLC.	IMPACT VELOCITY	62.58 mph (100.71 km/h)
TEST NUMBER	P35049-01	IMPACT ANGLE (°)	20.5
TEST DESIGNATION	3-44	MAXIMUM ROLL ANGLE (°)	-13.9
TEST DATE	10/27/15	MAXIMUM PITCH ANGLE (°)	-13.8
TEST ARTICLE		MAXIMUM YAW ANGLE (°)	120.3
NAME / MODEL	Sentry Longitudinal Energy Dissipater (SLED)	STOPPING DISTANCE	32.9 ft (10.0 m)
TYPE	Crash Cushion / End Treatment	IMPACT KINETIC ENERGY	648.7 kip-ft (879.5 kJ)
KEY ELEMENTS	Containment Impact Sled, Empty Primary Element, Water Filled Secondary Elements	OCCUPANT RISK VALUES	
CRASH CUSHION LENGTH	25.4 ft. (7.7 m)	OCCUPANT IMPACT VELOCITY	Longitudinal 35.1 ft/s (10.7 m/s)
ADJOINING BARRIER LENGTH	40.5 ft. (12.3 m)		Lateral 6.9 ft/s (2.1 m/s)
ROAD SURFACE	Concrete	RIDEDOWN ACCELERATION	Longitudinal -25.0 g
TEST VEHICLE			Lateral 8.7 g
TYPE / DESIGNATION	2270P	THIV	36.1 ft/s (11.0 m/s)
YEAR, MAKE AND MODEL	2009 Dodge Ram 1500	PHD	25.9 g
CURB MASS	4,952.6 lbs (2,246.5 kg)	ASI	1.34
TEST INERTIAL MASS	4,954.7 lbs (2,247.5 kg)	VEHICLE DAMAGE	
GROSS STATIC MASS	4,954.7 lbs (2,247.5 kg)	VEHICLE DAMAGE SCALE	1-FR-7
		COLLISION DAMAGE CLASSIFICATION	01FREE4

SECTION 4

MASH TEST 3-42 SUMMARY

Test Article: TrafFix Devices SLED
Test Program: MASH 3-42

Project No. P35237-01
Test Date: 12/02/15

SEQUENTIAL PHOTOGRAPHS

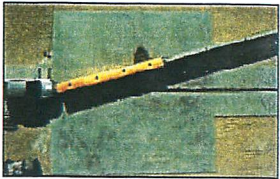

0.000 s

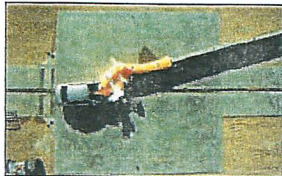

0.200 s



0.400 s



0.600 s



0.800 s



1.4 s

PLAN VIEW

-5 m 0 m 5 m 10 m 15 m 20 m 25 m 30 m 40 m 45 m 50 m 55 m 60 m

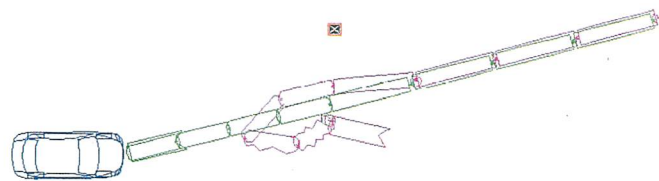

- Pre-Test Article
- Vehicle
- Post-Test Article
- Vehicle
- Debris

SECTION 4...(CONTINUED)

MASH TEST 3-42 SUMMARY

Test Article: TraFFix Devices SLEDProject No. P35237-01Test Program: MASH 3-42Test Date: 12/02/15

GENERAL INFORMATION		IMPACT AND EXIT CONDITIONS	
TEST AGENCY	KARCO Engineering, LLC.	IMPACT VELOCITY	61.94 mph (99.68 km/h)
TEST NUMBER	P35237-01	IMPACT ANGLE (°)	14.0
TEST DESIGNATION	3-42	MAXIMUM ROLL ANGLE (°)	10.9
TEST DATE	12/2/15	MAXIMUM PITCH ANGLE (°)	-5.9
TEST ARTICLE		MAXIMUM YAW ANGLE (°)	-9.2
NAME / MODEL	Sentry Longitudinal Energy Dissipater (SLED)	STOPPING DISTANCE	181.5 ft. (55.3 m)
TYPE	Crash Cushion / End Treatment	KINETIC ENERGY	313.4 kip-ft (424.9 kJ)
KEY ELEMENTS	Containment Impact Sled, Empty Primary Element, Water Filled Secondary Elements	OCCUPANT RISK VALUES	
CRASH CUSHION LENGTH	25.2 ft. (7.7 m)	OCCUPANT IMPACT VELOCITY	Longitudinal 30.5 ft/s (9.3 m/s)
ADJOINING BARRIER LENGTH	41.0 ft. (12.5 m)		Lateral 2.6 ft/s (0.8 m/s)
ROAD SURFACE	Concrete	RIDEDOWN ACCELERATION	Longitudinal -12.0 g
TEST VEHICLE			Lateral 5.1 g
TYPE / DESIGNATION	1100C	THIV	30.5 ft/s (9.3 m/s)
YEAR, MAKE AND MODEL	2010 Kia Rio	PHD	12.2 g
CURB MASS	2,497.8 lbs (1,133.0 kg)	ASI	1.0
TEST INERTIAL MASS	2,443.8 lbs (1,108.5 kg)	VEHICLE DAMAGE	
GROSS STATIC MASS	2,600.3 lbs (1,179.5 kg)	VEHICLE DAMAGE SCALE	12-FC-5
		COLLISION DAMAGE CLASSIFICATION	12FCEW3

SECTION 4

MASH TEST 3-43 SUMMARY

Test Article: TrafFix Devices SLED
Test Program: MASH 3-43

Project No. P35245-01
Test Date: 12/02/15

SEQUENTIAL PHOTOGRAPHS



0.000 s



0.200 s



0.400 s



0.600 s

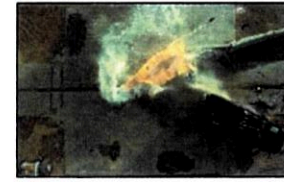

0.800 s

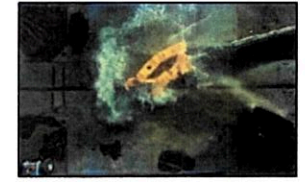

1.0 s

PLAN VIEW

-10 m -5 m 0 m 5 m 10 m 15 m 20 m 25 m 30 m 35 m 40 m 45 m 50 m



- Pre-Test Article
- Vehicle
- Post-Test Article
- Vehicle
- Debris



SECTION 4...(CONTINUED)
MASH TEST 3-43 SUMMARY

Test Article: TraFFix Devices SLED
 Test Program: MASH 3-43

Project No. P35245-01
 Test Date: 12/02/15

GENERAL INFORMATION		IMPACT AND EXIT CONDITIONS	
TEST AGENCY	KARCO Engineering, LLC.	IMPACT VELOCITY	60.17 mph (96.84 km/h)
TEST NUMBER	P35245-01	IMPACT ANGLE (°)	15.2
TEST DESIGNATION	3-43	MAXIMUM ROLL ANGLE (°)	5.1
TEST DATE	12/2/15	MAXIMUM PITCH ANGLE (°)	-4.7
TEST ARTICLE		MAXIMUM YAW ANGLE (°)	-25.3
NAME / MODEL	Sentry Longitudinal Energy Dissipater (SLED)	STOPPING DISTANCE	162.0 ft. (49.4 m)
TYPE	Crash Cushion / End Treatment	KINETIC ENERGY	595.0 kip-ft (807.0 kJ)
KEY ELEMENTS	Containment Impact Sled, Empty Primary Element, Water Filled Secondary Elements	OCCUPANT RISK VALUES	
CRASH CUSHION LENGTH	25.0 ft. (7.6 m)	OCCUPANT IMPACT VELOCITY	Longitudinal 25.9 ft/s (7.9 m/s)
ADJOINING BARRIER LENGTH	40.9 ft. (12.5 m)		Lateral 6.6 ft/s (2.0m/s)
ROAD SURFACE	Concrete	RIDEDOWN ACCELERATION	Longitudinal -4.8 g
TEST VEHICLE			Lateral 4.8 g
TYPE / DESIGNATION	2270P	THIV	26.6 ft/s (8.1 m/s)
YEAR, MAKE AND MODEL	2010 Dodge Ram 1500	PHD	6.8 g
CURB MASS	4,776.2 lbs (2,166.5 kg)	ASI	0.64
TEST INERTIAL MASS	4,917.3 lbs (2,230.5 kg)	VEHICLE DAMAGE	
GROSS STATIC MASS	4,917.3 lbs (2,230.5 kg)	VEHICLE DAMAGE SCALE	12-FC-5
		COLLISION DAMAGE CLASSIFICATION	12FCEW3

8 7 6 5 4 3 2 1

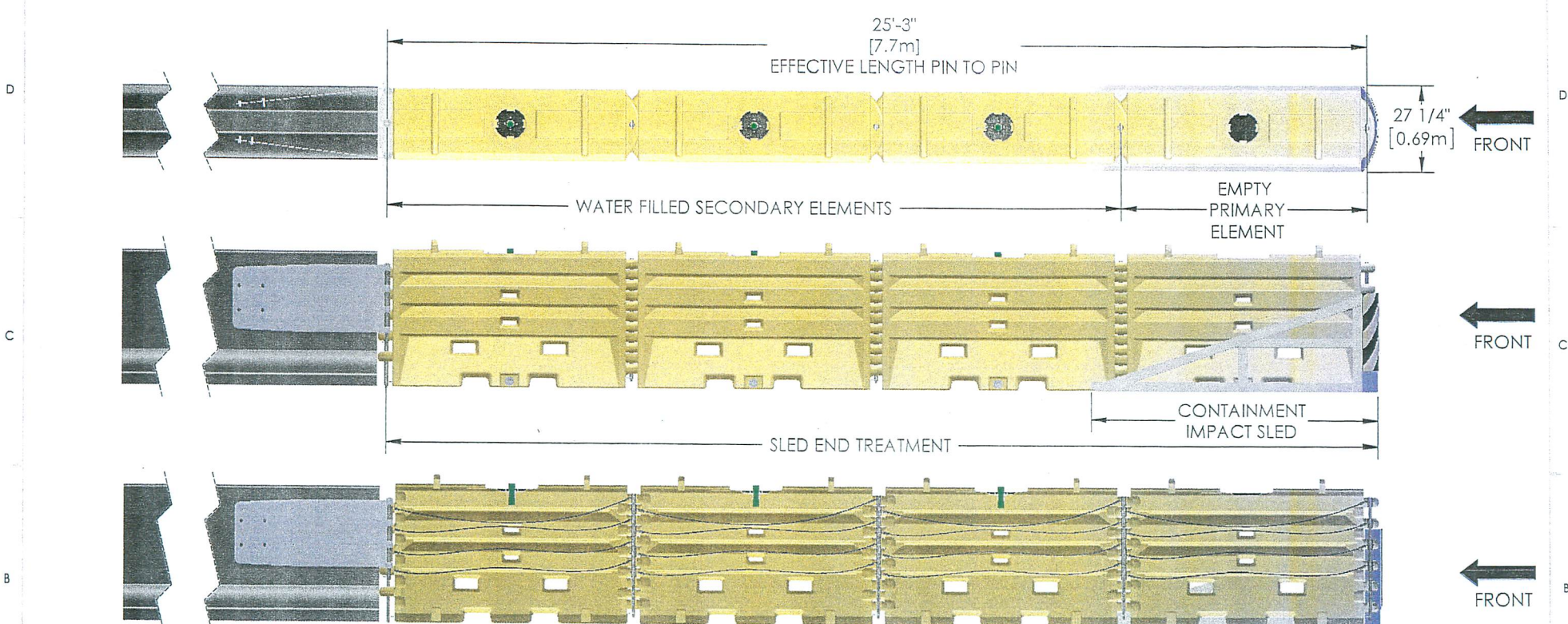

CUT AWAY SLED END TREATMENT
ALL SECTIONS CONTAIN INTERNAL MOLDED-IN CABLES.

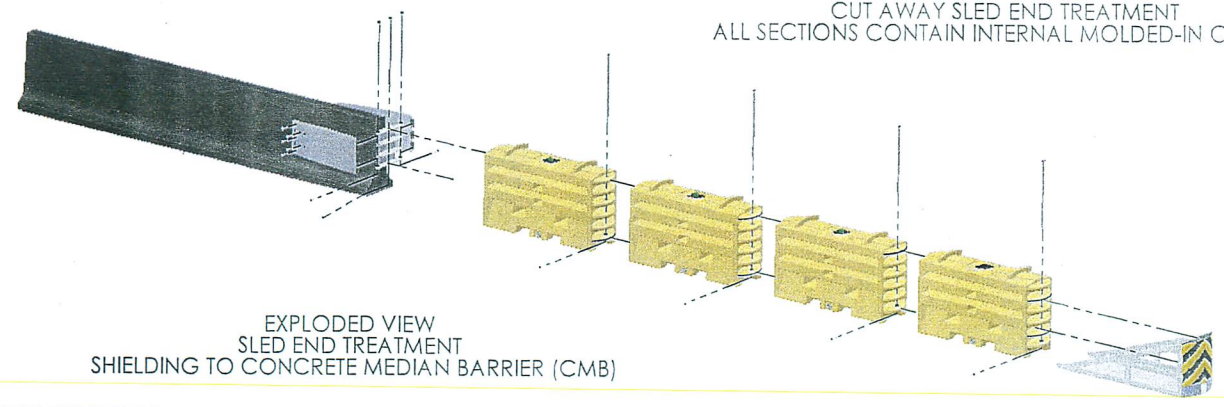

EXPLODED VIEW
SLED END TREATMENT
SHIELDING TO CONCRETE MEDIAN BARRIER (CMB)

UNLESS OTHERWISE SPECIFIED:
ALL DIMENSIONS ARE IN INCHES (mm).
TOLERANCES:
FRACTIONAL: X/8 ± 1" [25.4mm]
DECIMAL: .000 ± .0625
DEGREES: ± 0.5°



160 Avenida La Pata
San Clemente, CA 92673
(949) 361-5663
FAX (949) 361-9205
www.traffixdevices.com

TITLE:
**SLED END
TREATMENT W/ CMB**

DRAWN BY: JEREMY SMITH
CHECKED BY: FA
APPROVED BY: FA

DATE: 06-22-10
DATE: 06-22-10
DATE: 06-22-10

SIZE
B

DWG. NO.
300-105

REV
G

SHEET 1 OF 1

8 7 6 5 4 3 2 1

1 2 3 4 5 6 7 8

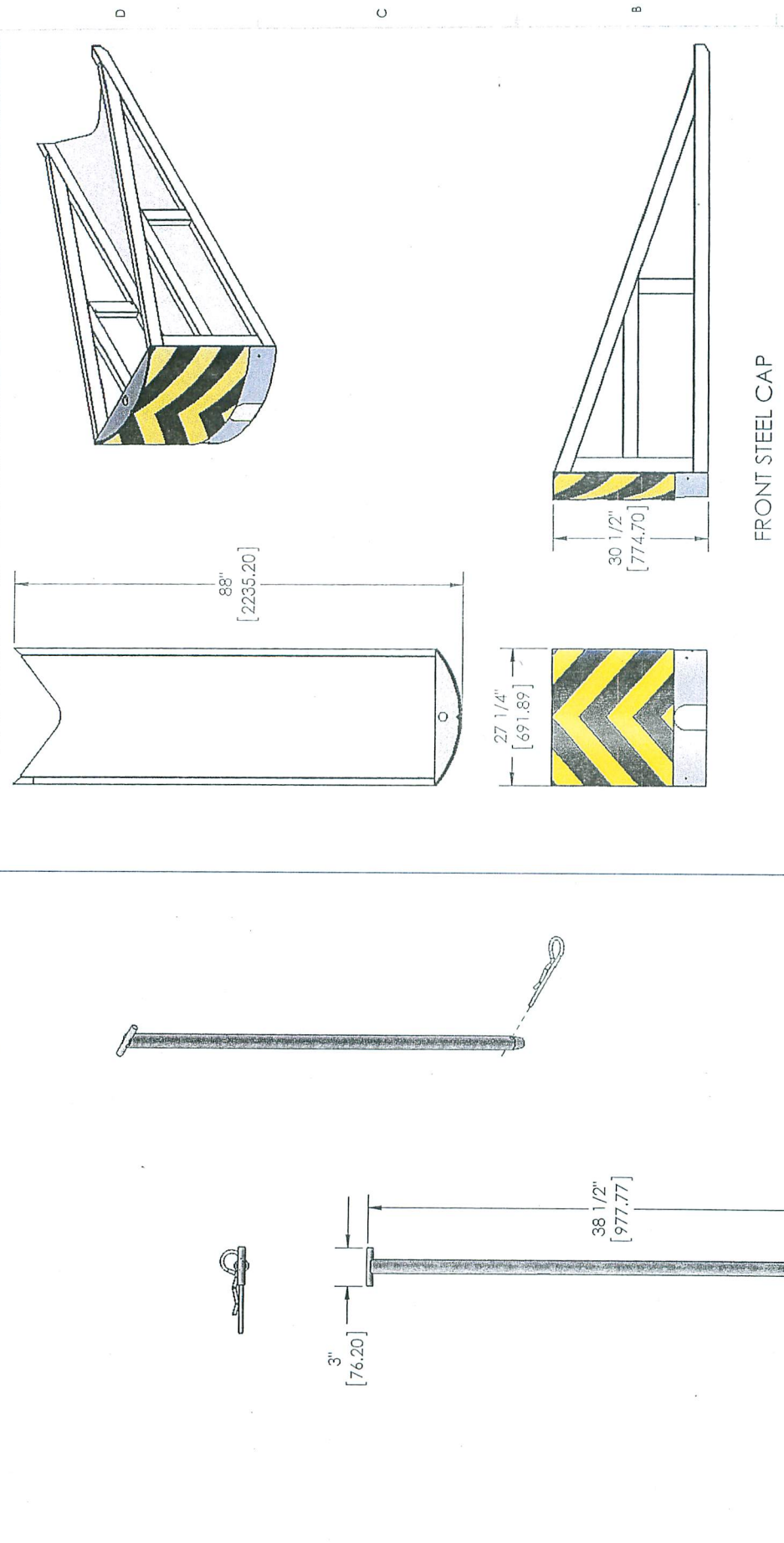

UNLESS OTHERWISE SPECIFIED:
 ALL DIMENSIONS ARE IN INCHES (mm).
 TOLERANCES: FRACTIONAL: X/8, 1/16" (1.4mm)
 DECIMAL: .005, .015, .031, .0625
 ANGLES: ± 0.5°

TrafFix
Devices Inc.
 160 Avenida La Pata
 San Clemente, CA 92673
 (949) 385-3885
 (949) 385-9205
 www.traffixdevices.com

TITLE:

**SLED END TREATMENT
 HARDWARE**

DATE:	02/25/10	REV:	F
CHECKED BY:	JEREMY SMITH	SIZE:	B
DATE:	10/14/09	DWG. NO.:	300-106
APPROVED BY:			

UNITS: INCHES [mm]
 MATERIAL: STEEL
 NOTES: UNLESS OTHERWISE SPECIFIED

SHEET 1 OF 2

8 7 6 5 4 3 2 1

D
C
B
A

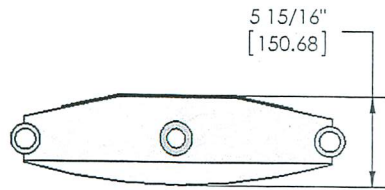

5 15/16"
[150.68]

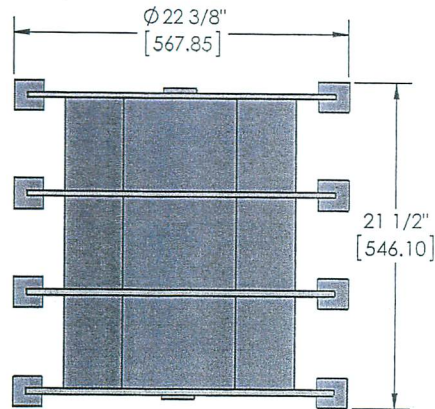
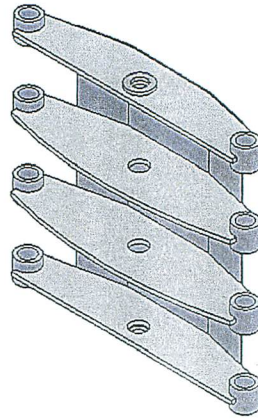

SLED END TREATMENT
TRANSITION FRAME

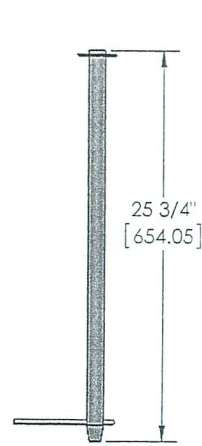

SHORT
OUTSIDE
TRANSITION PIN
W/ KEEPER PIN

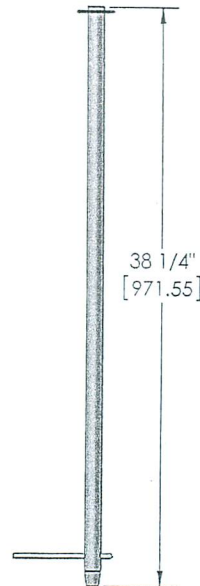

LONG
CENTER
TRANSITION PIN
W/ KEEPER PIN

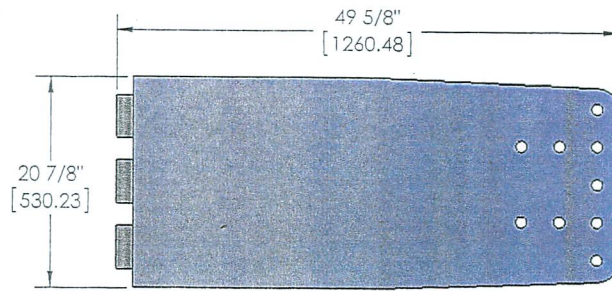

SLED END TREATMENT
TRANSITION PANEL

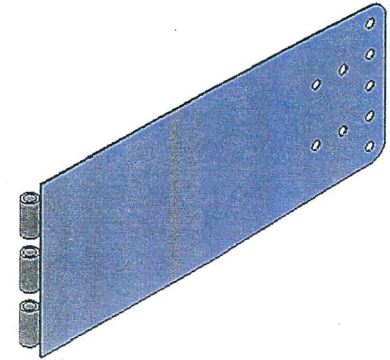

UNITS: INCHES [mm]
MATERIAL: STEEL
NOTES: UNLESS OTHERWISE SPECIFIED

UNLESS OTHERWISE SPECIFIED:
ALL DIMENSIONS ARE IN INCHES[mm].
TOLERANCES:
FRACTIONAL: X/8 ± 1/16" [1.6mm]
DECIMAL: .000 ± .0025
DEGREES: ± 0.5°



160 Avenida La Pata
San Clemente, CA 92673
(949) 361-5663
FAX (949) 361-9205
www.traffixdevices.com

TITLE:
**SLED END TREATMENT
HARDWARE**

DRAWN BY:
JEREMY SMITH
CHECKED BY:
FA
APPROVED BY:
FA

DATE:
02-29-10
DATE:
10-16-09
DATE:
10-16-09

SIZE
B

DWG. NO.
300-106

REV
F

SHEET 2 OF 2

8 7 6 5 4 3 2 1

1 2 3 4 5 6 7 8

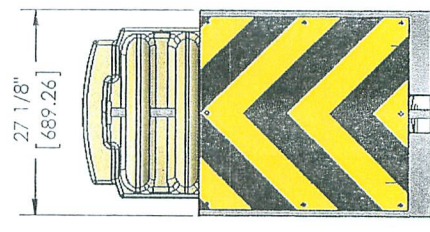
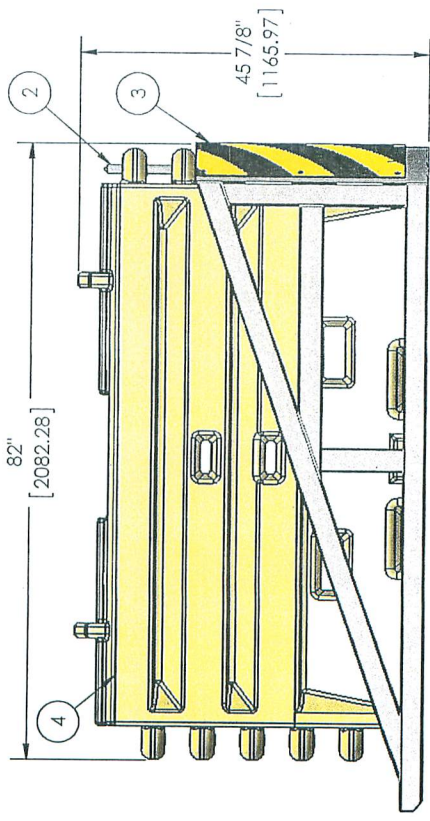
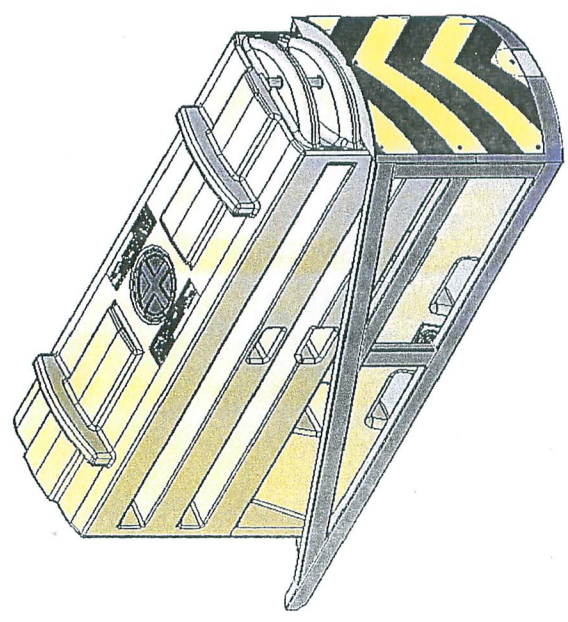
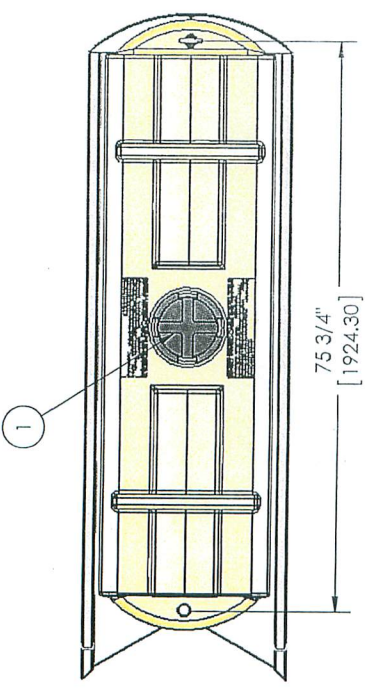

UNLESS OTHERWISE SPECIFIED:
 ALL DIMENSIONS ARE IN INCHES (mm).
 FRACTIONAL: 1/8" & 1/16" (1.6mm)
 DECIMAL: .001 ± .0025
 DECIMAL: ± .05

Traffix
Devices Inc.

160 Avenida La Paja
 San Clemente, CA 92673
 (949) 367-5663
 FAX: (949) 367-5663
 www.traffixdevices.com

TITLE:

**SLED END TREATMENT
 PRIMARY ELEMENT**

SIZE **B** DWG. NO. **326**

REV **G**

DESIGNED BY: JEREMY SMITH
 CHECKED BY: JFA
 DATE: 10-16-09
 APPROVED BY: JFA
 DATE: 10-16-09

ITEM NO.	DESCRIPTION
1	8" DIA FILL HOLE W/ TWIST LOCK LID
2	CONNECTION STEEL DROP PIN
3	FRONT STEEL SLED
4	SENTRY END TREATMENT

SHEET 1 OF 1

8 7 6 5 4 3 2 1

D

C

B

A

D

C

B

A

1 2 3 4 5 6 7 8

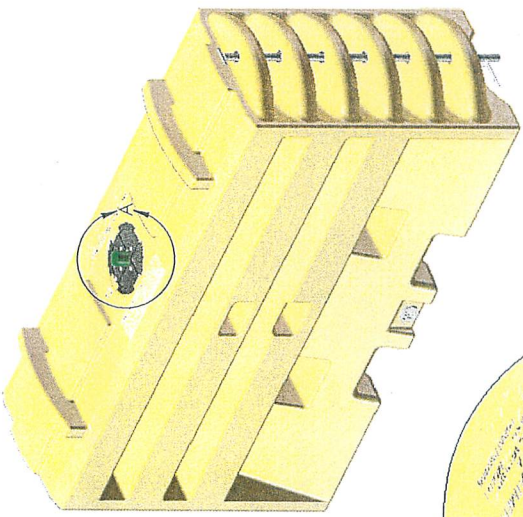

SLED END TREATMENT MODULE
FULL OR FILLED TO THE TOP

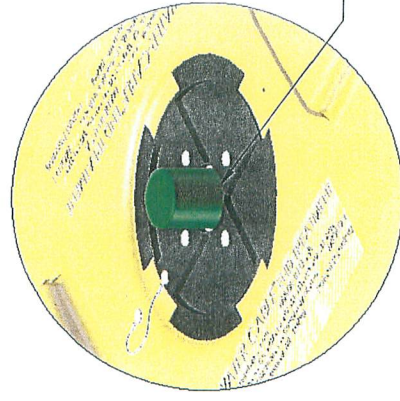

DETAIL A
SCALE 1 : 4

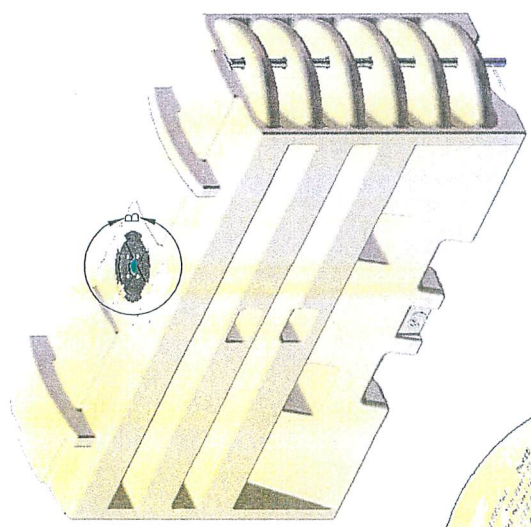

SLED END TREATMENT MODULE
EMPTY OR NOT FILLED TO THE TOP

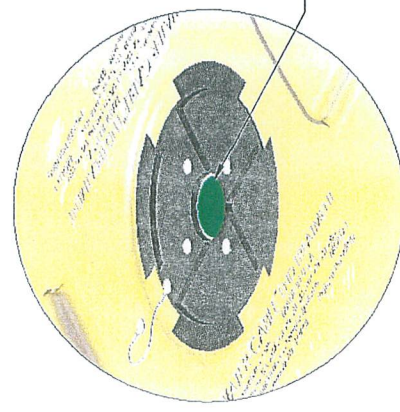

DETAIL B
SCALE 1 : 4

UNLESS OTHERWISE SPECIFIED:
ALL DIMENSIONS ARE IN INCHES (mm).
TOLERANCES: FRACTIONAL: 1/8, 1/16 (1.5mm)
DECIMALS: .005, .015, .030, .0625
DECIMALS: .005, .015, .030, .0625

TrafFix
Devices Inc.

160 Avenida La Pata
San Clemente, CA 92673
(949) 385-9205
www.traffixdevices.com

TITLE:

**SLED END TREATMENT
FLOAT COVER**

SIZE DWG. NO. REV
B **300-112** **C**

DATE: 08-03-10
DRAWN BY: JEREMY SMITH
CHECKED BY: PA
DATE: 08-03-10
APPROVED BY: PA

SHEET 1 OF 1

1 2 3 4 5 6 7 8

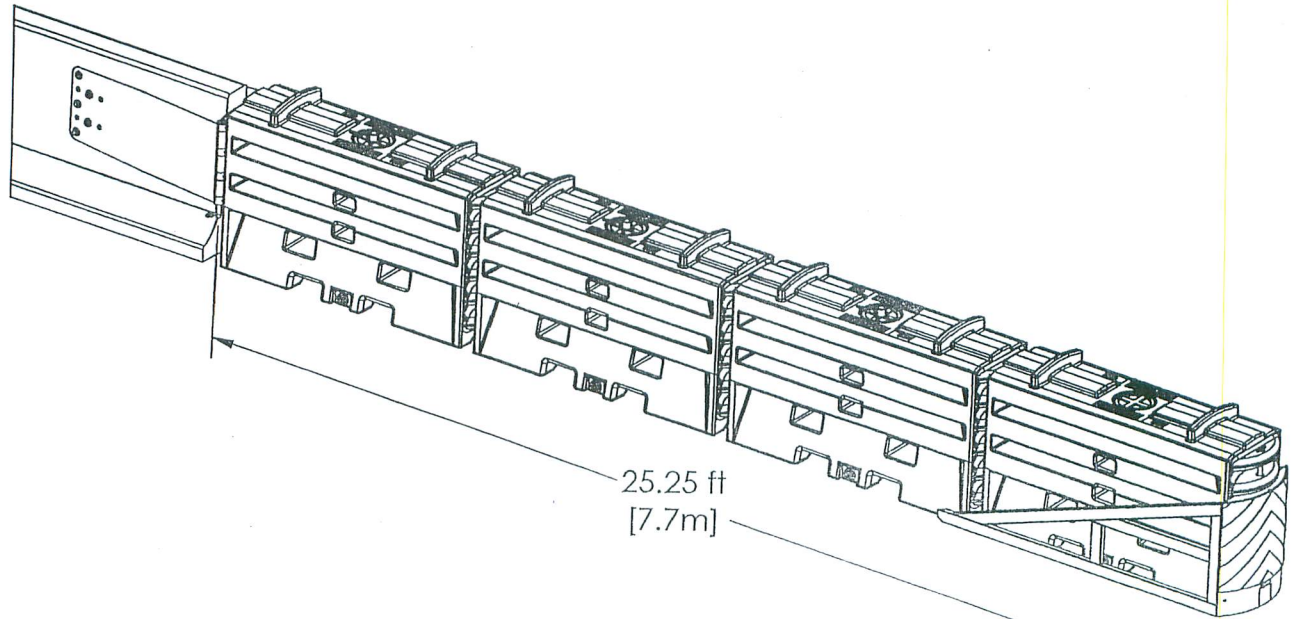

25.25 ft
[7.7m]

TRANSITION
PANELS

TRANSITION
PINS

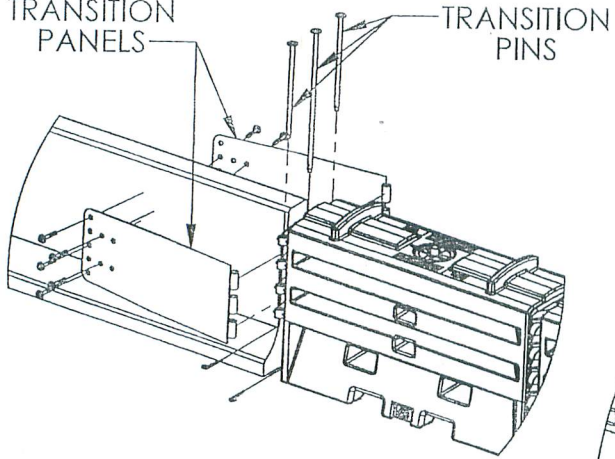

T-PIN

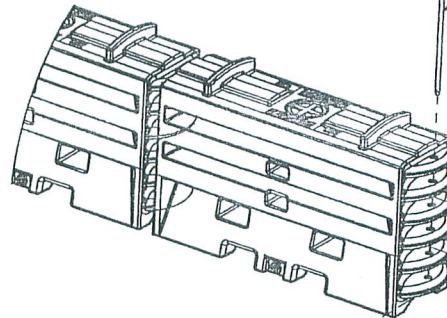

CONTAINMENT
IMPACT SLED

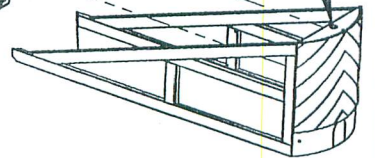

SLED END TREATMENT

**TraFFix
Devices Inc.**



SER##

SHEET NO.

DATE:

1 OF 2

08/15/2016

INTENDED USE

The Sentry Longitudinal Energy Dissipater (SLED) Crash Cushion is a narrow water-filled, non-redirective gating crash cushion designed to shield the end of rigid objects. The SLED End Treatment does not require anchor bolts to be secured to the road surface. The SLED system can be installed on asphalt and concrete road surfaces.

The MASH SLED TL-3 is the same design as the NCHRP-350 SLED TL-3 (reference acceptance letter CC-114). No changes were made to meet the safety evaluation criteria for MASH. Four yellow polyethylene plastic modules make up the TL-3 system. The front module is left empty and weighs approximately 150 lbs. [68 kg]. The Containment Impact Sled (CIS) is pinned to the front empty module. The three remaining modules used in a TL-3 application are water filled. When filled, each module weighs approximately 2000 lbs [907 kg]. The rearmost water filled module is positively connected to the steel transition frame. This is the same connection method used between adjacent modules and within the CIS and the empty front module. The transition panels are pinned to the transition frame using outboard alignment pins designed into the transition frame. The transition panels are attached to the rigid object using a minimum of four (4) mechanical fasteners per side. A minimum of eight (8) fasteners are required to properly secure the SLED to the rigid object.

SLED End Treatment

Length: 25.25 ft. (7.7 m) (Pin to Pin)- Four (4) Modules, TL-3 Version

Height: 3.8 ft. (1.2 m)

Width: 2.3 ft. (0.7 m)

The SLED End Treatment has been tested and passed the recommended procedures of NCHRP-350 and MASH.

ACCEPTANCE

FHWA Eligibility Letter:

CONTACT INFORMATION

TraFFix Devices, Inc.
Corporate Headquarters
160 Avenida La Pata
San Clemente, CA 92673
www.traffixdevices.com

Phone: +1(949)-361-5663

Fax: +1(949)-361-9205

Email: info@traffixdevices.com

SLED END TREATMENT

SER##

SHEET NO.

2 OF 2

DATE:

08/15/2016

TraFFix
Devices Inc.

