



U.S. Department
of Transportation
**Federal Highway
Administration**

July 20, 2020

1200 New Jersey Ave., SE
Washington, D.C. 20590

In Reply Refer To:
HSST-1/B-340

Mr. Ron Faulkenberry
Gibraltar Global LLC
1208 Houston Clinton Drive
Burnet, Texas 78611
USA

Dear Mr. Faulkenberry:

This letter is in response to your May 08, 2020 request for the Federal Highway Administration (FHWA) to review a roadside safety device, hardware, or system for eligibility for reimbursement under the Federal-aid highway program. This FHWA letter of eligibility is assigned FHWA control number B-340 and is valid until a subsequent letter is issued by FHWA that expressly references this device.

Decision

The following device is eligible within the length-of-need, with details provided in the form which is attached as an integral part of this letter:

- Gibraltar Global TL-3 Cable Barrier System, 4H:1V Slope

Scope of this Letter

To be found eligible for Federal-aid funding, new roadside safety devices should meet the crash test and evaluation criteria contained in the American Association of State Highway and Transportation Officials' (AASHTO) Manual for Assessing Safety Hardware (MASH). However, the FHWA, the Department of Transportation, and the United States Government do not regulate the manufacture of roadside safety devices. Eligibility for reimbursement under the Federal-aid highway program does not establish approval, certification or endorsement of the device for any particular purpose or use.

This letter is not a determination by the FHWA, the Department of Transportation, or the United States Government that a vehicle crash involving the device will result in any particular outcome, nor is it a guarantee of the in-service performance of this device. Proper manufacturing, installation, and maintenance are required in order for this device to function as tested.

This finding of eligibility is limited to the crashworthiness of the system and does not cover other structural features, nor conformity with the Manual on Uniform Traffic Control Devices.

Eligibility for Reimbursement

Based solely on a review of crash test results and certifications submitted by the manufacturer, and the crash test laboratory, FHWA agrees that the device described herein meets the crash test and evaluation criteria of the AASHTO's MASH. Therefore, the device is eligible for reimbursement under the Federal-aid highway program if installed under the range of tested conditions.

Name of system: Gibraltar Global TL-3 Cable Barrier System, 4H:1V Slope

Type of system: Longitudinal Barrier

Test Level: MASH Test Level 3 (TL3)

Testing conducted by: Applus IDIADA KARCO Engineering, LLC.

Date of request: May 08, 2020

FHWA concurs with the recommendation of the accredited crash testing laboratory on the attached form.

Full Description of the Eligible Device

The device and supporting documentation, including reports of the crash tests or other testing done, videos of any crash testing, and/or drawings of the device, are described in the attached form.

Notice

This eligibility letter is issued for the subject device as tested. Modifications made to the device are not covered by this letter. Any modifications to this device should be submitted to the user (i.e., state DOT) as per their requirements.

You are expected to supply potential users with sufficient information on design, installation and maintenance requirements to ensure proper performance.

You are expected to certify to potential users that the hardware furnished has the same chemistry, mechanical properties, and geometry as that submitted for review, and that it will meet the test and evaluation criteria of AASHTO's MASH.

Issuance of this letter does not convey property rights of any sort or any exclusive privilege. This letter is based on the premise that information and reports submitted by you are accurate and correct. We reserve the right to modify or revoke this letter if: (1) there are any inaccuracies in the information submitted in support of your request for this letter, (2) the qualification testing was flawed, (3) in-service performance or other information reveals safety problems, (4) the system is significantly different from the version that was crash tested, or (5) any other information indicates that the letter was issued in error or otherwise does not reflect full and complete information about the crashworthiness of the system.

Standard Provisions

- To prevent misunderstanding by others, this letter of eligibility designated as FHWA control number B-340 shall not be reproduced except in full. This letter and the test documentation upon which it is based are public information. All such letters and documentation may be reviewed upon request.
- This letter shall not be construed as authorization or consent by the FHWA to use, manufacture, or sell any patented system for which the applicant is not the patent holder.
- This FHWA eligibility letter is not an expression of any Agency view, position, or determination of validity, scope, or ownership of any intellectual property rights to a specific device or design. Further, this letter does not impute any distribution or licensing rights to the requester. This FHWA eligibility letter determination is made based solely on the crash-testing information submitted by the requester. The FHWA reserves the right to review and revoke an earlier eligibility determination after receipt of subsequent information related to crash testing.

Sincerely,



Michael S. Griffith
Director, Office of Safety Technologies
Office of Safety

Enclosures

Request for Federal Aid Reimbursement Eligibility of Highway Flexible Barriers

Submitter	Date of Request:	July 15, 2020	<input checked="" type="radio"/> New <input type="radio"/> Resubmission
	Name:	Bruno Haesbaert	
	Company:	Applus IDIADA KARCOEngineering, LLC.	
	Address:	9270 Holly Road, Adelanto, CA 92301	
	Country:	United States of America	
	To:	Michael S. Griffith, Director FHWA, Office of Safety Technologies	

I request the following devices be considered eligible for reimbursement under the Federal-aid highway program.

Device & Testing Criterion

System Type	Submission Type	Device Name / Variant	Testing Criterion	Test Level
'B': Flexible Barriers Barrier Placement in V-Ditch S: Single Barrier; D: Double Barrier SBP: Slope Break Point S or D: 0 to 4ft. Offset SBP 4H:1V	Physical Testing <input checked="" type="radio"/>	Gibraltar Global TL-3 Cable Barrier System	AASHTO MASH	TL3

By submitting this request for review and evaluation by the Federal Highway Administration, I certify that the product(s) was (were) tested in conformity with the AASHTO Manual for Assessing Safety Hardware and that the evaluation results meet the appropriate evaluation criteria in the MASH.

Individual or Organization responsible for the product:

Contact Name:	Ron Faulkenberry	Same as Submitter <input type="checkbox"/>
Company Name:	Gibraltar Global LLC	Same as Submitter <input type="checkbox"/>
Address:	1208 Houston Clinton Drive, Burnet, Texas 78611	Same as Submitter <input type="checkbox"/>
Country:	United States of America	Same as Submitter <input type="checkbox"/>

Enter below all disclosures of financial interests as required by the FHWA 'Federal-Aid Reimbursement Eligibility Process for Safety Hardware Devices' document.

Gibraltar Global, LLC. and Applus IDIADA Karco Engineering, LLC. share no (\$0.00) financial interests between the two organizations. This includes no (\$0.00) financial interest but not limited to:

- i. Compensation, including wages, salaries, commissions, professional fees, or fees for business referrals (dollar values are not needed);
- ii. Consulting relationships;
- iii. Research funding or other forms of research support;
- iv. Patents, copyrights, and other intellectual property interests;
- v. Licenses or contractual relationships; or
- vi. Business ownership and investment interest

[Help](#)

PRODUCT DESCRIPTION

- New Hardware or
- Significant Modification

The Gibraltar Global TL-3 Cable Barrier System is a high tension 4-cable longitudinal barrier. The barrier consists of four (4) 0.75 in. (19 mm) steel cables, C-section steel posts, steel sockets, aluminum hair pins and steel lock plates. The C-section posts were placed on alternating sides of the cables and aluminum hair pins held the cables in place. The top two (2) cables of the system were stitched together making the cables alternate in the top hairpin location. The hair pins held the cables at 20.0 in (508 mm), 30.0 in (762 mm) and 39.0 in. (991 mm) above grade. The cable barrier system was terminated on both ends with Gibraltar end terminals. The total as-tested length was 613.7 ft. (187.1 m) long. As recommended in MASH the cable tension was set to the recommended tension at 100 degrees Fahrenheit. The cables were tensioned to 4200 lbs (18.7 kN). The post spacings used for this test series were as follows:

- Flat Terrain narrowest: 7.0 ft. (2.1 m)
- Flat Terrain widest: 21.0 ft. (6.4 m)
- 4h:1V Ditch narrowest: 7.0 ft. (2.1 m)
- 4h:1V Ditch widest: 16.0 ft. (4.9 m).

Test 4-10 and 4-11 were tested on flat terrain and were run as a part of the TL-4 submittal for letter B-316. Test 3-10 and 3-11 were tested on flat terrain. Tests 3-13, 3-14, 3-16, 3-17, and 3-18 were tested in a 46 ft. wide 4H:1V V-ditch. The road surface of the ditch was a minimum of 6 in. deep compacted AASHTOM 147-65 soil. The post sockets were embedded in 12 in. diameter by 36 in. deep concrete foundations with a minimum compressive strength of 2500 psi. Tests 3-13, 3-14, and 3-17 were positioned on the front slope while 3-16 and 3-18 were positioned on the back slope.

Gibraltar also offers various post and socket options such as concrete socket foundations with steel or plastic sockets, driven steel sockets, and direct driven posts. Other options include swaged and wedge-type fittings which were installed and crash tested. Pre-stretched and non pre-stretched cable are permissible.

There was one modification made during the testing of the Gibraltar Global TL-34 Cable Barrier System during the MASH test program. Tests 3-11, 3-17, and 3-18 use the widest post spacing configuration. Test 3-11 used 21.0 ft. (6.4 m) and 3-17 used 18.0 ft. (5.5 m) post spacing. For Test 3-18, the post spacing for the line posts was reduced from 18.0 ft. (5.5 m) to 16.0 ft. (4.9 m). Complete details on the design modification is included in Attachment A to this submission and in the complete test reports.

A brief description of each crash test and its result:

Help

Required Test Number	Narrative Description	Evaluation Results
3-10 (1100C)	<p>Test 4-10 is the same as Test 3-10 and was run as a part of the TL-4 submittal for letter B-316. Therefore, Test 3-10 was not re-run, but the same information was used for this submittal.</p> <p>Applus IDIADA KARCO Engineering Project number P37379-01 was conducted with an 1100C test vehicle impacting the system midspan between posts at a nominal velocity and angle of 62 mph and 25 degrees, respectively. As recommended by MASH 2016 the narrowest allowable post spacing of 7.0 ft. (2.1 m) was used.</p> <p>The test vehicle, a 2011 Kia Rio weighing 2,427.2 lbs (1,101.0 kg) impacted the system at a speed and angle of 62.38 mph (100.39 km/h) and 25.1 degrees, respectively. The system redirected the vehicle and had a maximum working width of 7.6 ft. (2.3 m). The test vehicle sustained moderate damage. There was no potential for the article to penetrate the vehicle and the occupant compartment deformation limits were not exceeded. The Occupant Impact Velocities (OIV) and ridedown accelerations are within the recommended limits.</p>	PASS

Required Test Number	Narrative Description	Evaluation Results
3-11 (2270P)	<p>As recommend by MASH 2016 the narrowest allowable post spacing of 7.0 ft. (2.1 m) and the widest allowable post spacing of 21.0 ft. (6.4 m) was tested with the 2270P test vehicle.</p> <p>Test 4-11 is the same as Test 3-11 and was run asa part of the TL-4 submittal for letter B-316. Therefore, Test 3-11 was not re-run, but the same information was used for this submittal. Both tests referenced here were part of the TL-4 submittal for letter B-316.</p> <p>Applus IDIADA KARCO Engineering Project number P37358-01 was conducted with a 2270P test vehicle impacting the system 1.0 ft. (0.3 m) upstream of a post with the narrowest allowable post spacing of 7.0 ft. (2.1 m) at a nominal velocity and angle of 62 mph and 25 degrees, respectively. The test vehicle, a 2013 Chevrolet Silverado weighing 5,011.0 lbs (2,273.0 kg) impacted the system at aspeed and angle of 60.93 mph (98.06 km/h) and 25.3 degrees, respectively. The system redirected the vehicle and had a maximum working width of 7.9 ft. (2.4 m). The test vehicle sustained moderate damage. There was no potential for the article to penetrate the vehicle and the occupant compartment deformation limits were not exceeded. The Occupant Impact Velocities (OIV) and ridedown accelerations are within the recommended limits.</p> <p>Applus IDIADA KARCO Engineering Project number P37359-01 was conducted with a 2270P test vehicle impacting the system 1.0 ft. (0.3 m) upstream of a post with the widest allowable post spacing of 21.0 ft (6.4 m) at a nominal velocity and angle of 62 mph and 25 degrees, respectively. The test vehicle, a 2013 Chevrolet Silverado weighing 5,028.7 lbs (2,281.0 kg) impacted the system at aspeed and angle of 61.78 mph (99.43 km/h) and 25.1 degrees, respectively. The system redirected the vehicle and had a maximum working width of 13.8 ft. (4.2 m). The test vehicle sustained moderate damage. There was no potential for the article to penetrate the vehicle and the occupant compartment deformation limits were not exceeded. The Occupant Impact Velocities (OIV) and ridedown accelerations are within the recommended limits.</p>	PASS

3-13 (2270P)	<p>Applus IDIADA KARCOEngineering Project number P38018-01 was conducted with a 2270P test vehicle impacting the system at a nominal velocity and angle of 62 mph and 25 degrees, respectively. The system was installed 4 ft. from the front SBP of a 46 ft. wide 4H:1V V-ditch. As recommend by MASH 2016 the narrowest allowable post spacing of 7.0 ft. (2.1 m) was used.</p> <p>The test vehicle, a 2012 Chevrolet Silverado 1500 with a test inertial weight of 5,026.5 lbs (2,280.0 kg) impacted the system at a speed and angle of 63.31 mph (101.89 km/h) and 25.7 degrees, respectively. The system redirected the vehicle and had a maximum working width of 12.5 ft. (3.8 m). The test vehicle sustained moderate damage. There was no potential for the article to penetrate the vehicle and the occupant compartment deformation limits were not exceeded. The Occupant Impact Velocities (OIV) and ridedown accelerations are within the recommended limits.</p>	PASS
3-14 (1100C)	<p>Applus IDIADA KARCOEngineering Project number P38112-01 was conducted with an 1100C test vehicle impacting the system at a nominal velocity and angle of 62 mph and 25 degrees, respectively. The system was installed 4 ft. from the front SBP of a 46 ft. wide 4H:1V V-ditch. As recommend by MASH 2016 the narrowest allowable post spacing of 7.0 ft. (2.1 m) was used.</p> <p>The test vehicle, a 2012 KiaRio with a test inertial weight of 2,428.4 lbs (1,101.5 kg) impacted the system at a speed and angle of 60.97 mph (98.12 km/h) and 25.3 degrees, respectively. The system redirected the vehicle and had a maximum working width of 5.5 ft. (1.7 m). The test vehicle sustained moderate damage. There was no potential for the article to penetrate the vehicle and the occupant compartment deformation limits were not exceeded. The Occupant Impact Velocities (OIV) and ridedown accelerations are within the recommended limits.</p>	PASS
3-15 (1100C)	<p>Per MASH2016 this test is not applicable for V-ditches greater than or equal to 26 ft, measured from the front SBP to the back SBP. This test is also not necessary for double median systems placed within a median ditch, one on each side and 0 to 4 ft from a SBP.</p>	Non-Relevant Test, not conducted

<p>3-16 (2270P)</p>	<p>Applus IDIADA KARCOEngineering Project number P39320-01 was conducted with an 1100C test vehicle impacting the system at a nominal velocity and angle of 62 mph and 25 degrees, respectively. The system was installed 4 ft. from the back SBP of a 46 ft. wide 4H:1V V-ditch. As recommend by MASH 2016 the narrowest allowable post spacing of 7.0 ft. (2.1 m) was used.</p> <p>The test vehicle, a 2009 KiaRio with a test inertial weight of 2,431.7 lbs (1,103.0 kg) entering the ditch at aspeed and angle of 61.91 mph (99.63 km/h) and 25.0 degrees, respectively. The system redirected the vehicle and had a maximum working width of 3.0 ft (0.9 m). The test vehicle sustained damage to the front end. There was no potential for the article to penetrate the vehicle and the occupant compartment deformation limits were not exceeded. The Occupant Impact Velocities (OIV) and ridedown accelerations are within the recommended limits.</p>	<p>PASS</p>
<p>3-17 (1500A)</p>	<p>Applus IDIADA KARCOEngineering Project number P38113-02 was conducted with a 1500A test vehicle impacting the system at a nominal velocity and angle of 62 mph and 25 degrees, respectively. The system was installed 2 ft. from the front SBP of a 46 ft. wide 4H:1VV-ditch. With the system offset 2 ft. from the SBP the vehicle had the highest propensity to penetrate the system. As recommend by MASH 2016 the widest allowable post spacing of 18.0 ft. (5.5 m) was used.</p> <p>The test vehicle, a 2012 Chevrolet Malibu with a test inertial weight of 3,244.0 lbs (1,471.5 kg) impacted the system at aspeed and angle of 64.73 mph (104.17 km/h) and 24.6 degrees, respectively. The system redirected the vehicle and had a maximum working width of 13.5 ft. (4.1 m). The test vehicle sustained moderate damage. There was no potential for the article to penetrate the vehicle and the occupant compartment deformation limits were not exceeded. The Occupant Impact Velocities (OIV) and ridedown accelerations are within the recommended limits.</p>	<p>PASS</p>

3-18 (2270P)	<p>Applus IDIADA KARCOEngineering Project number P40079-01 was conducted with an 2270P test vehicle impacting the system at a nominal velocity and angle of 62 mph and 25 degrees, respectively. The system was installed 8 ft. from the back SBP of a 46 ft. wide 4H:1V V-ditch. As recommend by MASH 2016 the widest allowable post spacing of 16.0 ft. (4.9m) was used.</p> <p>The test vehicle, a 2016 Chevrolet Silverado with a test inertial weight of 5,011.0 lbs (2,273.0 kg) entering the ditch at aspeed and angle of 62.92 mph (101.26 km/h) and 25.1 degrees, respectively. The system redirected the vehicle and had a maximum working width of 15.0 ft (4.6 m). The test vehicle sustained damage to the front end. There was no potential for the article to penetrate the vehicle and the occupant compartment deformation limits were not exceeded. The Occupant Impact Velocities (OIV) and ridedown accelerations are within the recommended limits.</p>	PASS
--------------	--	------

Full Scale Crash Testing was done in compliance with MASH by the following accredited crash test laboratory (cite the laboratory’s accreditation status as noted in the crash test reports.):

Laboratory Name:	KARCOEngineering, INC	
Laboratory Signature:	Bruno Haesbaert	Digitally signed by Bruno Haesbaert Date: 2020.07.15 15:58:04 -07'00'
Address:	9270 Holly Road, Adelanto, CA 92301	Same as Submitter <input type="checkbox"/>
Country:	United States of America	Same as Submitter <input type="checkbox"/>
Accreditation Certificate Number and Dates of current Accreditation period :	TL-371: July 2019 - July 2022	

Submitter Signature*: Bruno Haesbaert Digitally signed by Bruno Haesbaert
Date: 2020.07.15 15:58:15 -07'00'

Submit Form

ATTACHMENTS

Attach to this form:

- 1) Additional disclosures of related financial interest as indicated above.
- 2) A copy of the full test report, video, and a Test Data Summary Sheet for each test conducted in support of this request.
- 3) A drawing or drawings of the device(s) that conform to the Task Force-13 Drawing Specifications [[Hardware Guide Drawing Standards](#)]. For proprietary products, a single isometric line drawing is usually acceptable to illustrate the product, with detailed specifications, intended use, and contact information provided on the reverse. Additional drawings (not in TF-13 format) showing details that are relevant to understanding the dimensions and performance of the device should also be submitted to facilitate our review.

FHWA Official Business Only:

Eligibility Letter		
Number	Date	Key Words

MASH Test 4-11 Summary

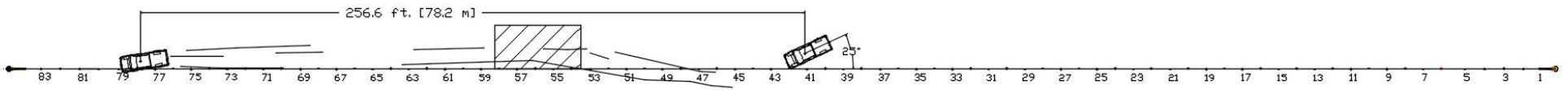
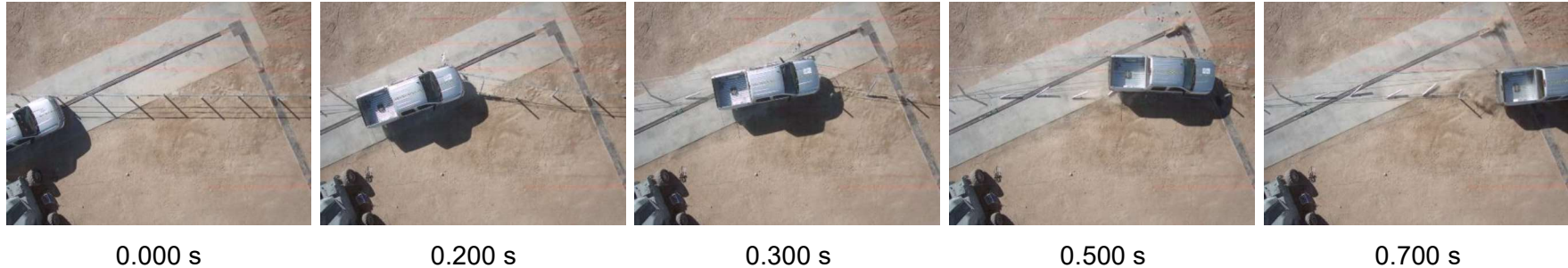

GENERAL INFORMATION	
Test Agency.....	Applus IDIADA KARCO
KARCO Test No.....	P37358-01
Test Designation.....	4-11
Test Date.....	12/07/18
TEST ARTICLE	
Name / Model.....	TL-4 Cable Barrier System
Type.....	Longitudinal Barrier
Installation Length.....	597.7 ft. (182.2 m)
Post Spacing.....	7.0 ft (2.1 m)
Key Elements.....	Cable, Hair Pins, Lock Plates
Road Surface.....	Concrete and soil
TEST VEHICLE	
Type / Designation.....	2270P
Year, Make, and Model....	2013 Chevrolet Silverado 1500
Curb Mass.....	5,261.2 lbs (2,386.5 kg)
Test Inertial Mass.....	5,011.0 lbs (2,273.0 kg)
Gross Static Mass.....	5,011.0 lbs (2,273.0 kg)

Impact Conditions	
Impact Velocity.....	60.93 mph (98.06 km/h)
Impact Angle.....	25.3°
Location / Orientation.....	1.5 in. upstream from Post 42
Impact Severity.....	113.6 kip-ft (154.0 kJ)
Exit Conditions	
Exit Velocity.....	36.7 mph (59.1 km/h)
Exit Angle.....	6.2°
Final Vehicle Position.....	256.6 ft. (78.2 m) Downstream
	3.1 ft. (0.9 m) Right
Exit Box Criterion.....	Exited within exit box
Vehicle Snagging.....	None
Vehicle Pocketing.....	None
Maximum Roll Angle.....	5.4 °
Maximum Pitch Angle.....	3.6 °
Maximum Yaw Angle.....	-26.3 °

Occupant Risk	
Longitudinal OIV.....	9.2 ft/s (2.8 m/s)
Lateral OIV.....	12.1 ft/s (3.7 m/s)
Longitudinal RA.....	-4.0 g
Lateral RA.....	5.6 g
THIV.....	15.7 ft/s (4.8 m/s)
PHD.....	5.3 g
ASI.....	0.41
Test Article Deflections	
Static.....	0.5 ft. (0.2 m)
Dynamic.....	7.9 ft. (2.4 m)
Working Width.....	7.9 ft. (2.4 m)
Debris Field.....	10.0 ft. (3.0 m) Field side
Vehicle Damage	
Vehicle Damage Scale.....	11-LFQ-3
CDC.....	11LYEW2
Maximum Intrusion.....	0.5 in. (13 mm)

Figure 3 Summary of Test 4-11

MASH Test 4-11 Summary

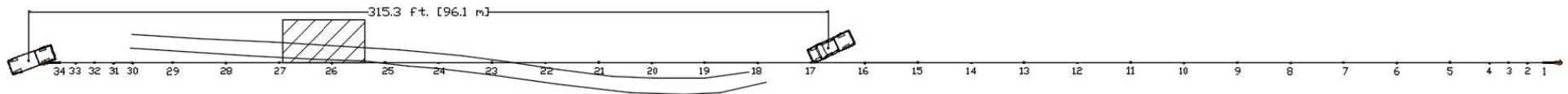
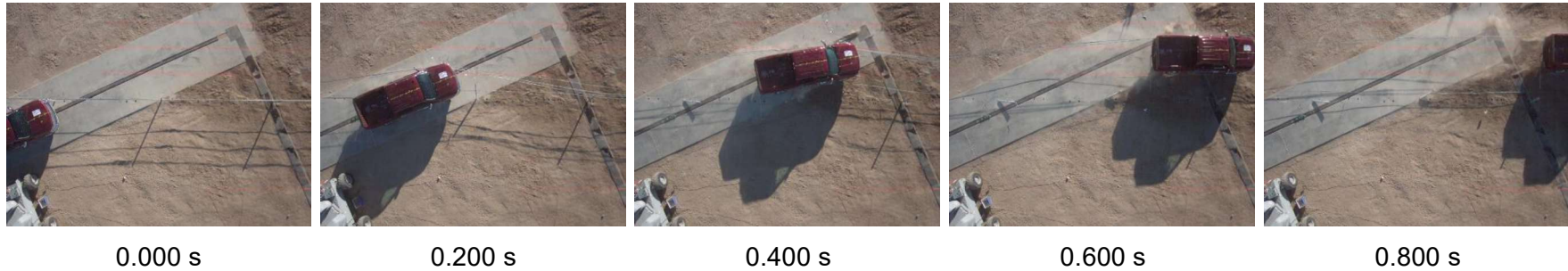

GENERAL INFORMATION	
Test Agency.....	Applus IDIADA KARCO
KARCO Test No.....	P37359-01
Test Designation.....	4-11
Test Date.....	12/07/18
TEST ARTICLE	
Name / Model.....	TL-4 Cable Barrier System
Type.....	Longitudinal Barrier
Installation Length.....	597.7 ft. (182.2 m)
Post Spacing.....	21.0 ft. (6.4 m)
Key Elements.....	Cable, Hair Pins, Lock Plates
Road Surface.....	Concrete and Soil
TEST VEHICLE	
Type / Designation.....	2270P
Year, Make, and Model.....	2013 Chevrolet Silverado 1500
Curb Mass.....	5,067.2 lbs (2,298.5 kg)
Test Inertial Mass.....	5,028.7 lbs (2,281.0 kg)
Gross Static Mass.....	5,028.7 lbs (2,281.0 kg)

Impact Conditions	
Impact Velocity.....	61.78 mph (99.43 km/h)
Impact Angle.....	25.1°
Location / Orientation.....	11.5 in. (292 mm) upstream from post 17
Impact Severity.....	115.5 kip-ft (156.5 kJ)
Exit Conditions	
Exit Velocity.....	47.40 mph (76.28 km/h)
Exit Angle.....	2.4°
Final Vehicle Position.....	315.3 ft. (96.1 m) Downstream
	0.7 ft. (0.2 m) Traffic side
Exit Box Criteria Met.....	Yes
Vehicle Snagging.....	Satisfactory
Vehicle Pocketing.....	Satisfactory
Maximum Roll Angle.....	-3.1°
Maximum Pitch Angle.....	-2.9°
Maximum Yaw Angle.....	-25.7°

Occupant Risk	
Longitudinal OIV.....	8.5 ft/s (2.6 m/s)
Lateral OIV.....	9.5 ft/s (2.9 m/s)
Longitudinal RA.....	-2.6 g
Lateral RA.....	3.4 g
THIV.....	13.1 ft/s (4.0 m/s)
PHD.....	3.7 g
ASI.....	0.31
Test Article Deflections	
Static.....	N/A
Dynamic.....	13.8 ft. (4.2 m)
Working Width.....	13.8 ft. (4.2 m)
Debris (lateral).....	14.5 ft. (4.4 m)
Vehicle Damage*	
Vehicle Damage Scale.....	11-LFQ-3
CDC.....	11LFEN2
Maximum Intrusion.....	none

*Vehicle damaged assessed before secondary impact.

Figure 4 Summary of Test 4-11

MASH Test 3-14 Summary



0.000 s

0.200 s

0.400 s

0.600 s

1.600 s

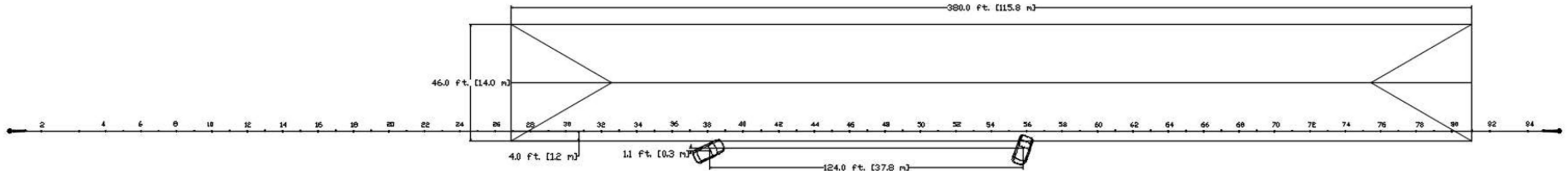

GENERAL INFORMATION

Test Agency..... Applus IDIADA KARCO Engineering
 Test No..... P38112-01
 Test Designation..... 3-14
 Test Date..... 04/02/18

TEST ARTICLE

Name / Model..... TL-4 Cable Barrier System
 Type..... Longitudinal Barrier
 Installation Length..... 613.7 ft. (187.1 m)
 Key Elements..... Cable, Hair Pins, Lock Plates
 Road Surface..... AASHTO M147-65 Grade B
 Post Spacing..... 7.0 ft. (2.1 m)

TEST VEHICLE

Type / Designation..... 1100C
 Year, Make, and Model..... 2012 Kia Rio
 Curb Mass..... 2,401.9 lbs (1,089.5 kg)
 Test Inertial Mass..... 2,428.4 lbs (1,101.5 kg)
 Gross Static Mass..... 2,599.2 lbs (1,179.0 kg)

Impact Conditions

Impact Velocity..... 60.97 mph (98.12 km/h)
 Impact Angle..... 25.3°
 Location / Orientation..... Midspan between posts
 Impact Severity..... 55.1 kip-ft (74.7 kJ)

Exit Conditions

Exit Velocity..... Vehicle did not exit
 Exit Angle..... N/A
 Final Vehicle Position..... 124.0 ft. (37.8 m) Downstream
 1.1 ft. (0.3 m) Left
 Exit Box Criteria Met..... N/A
 Vehicle Snagging..... None
 Vehicle Pocketing..... Satisfactory
 Maximum Roll Angle..... 48.6 °
 Maximum Pitch Angle..... 16.6 °
 Maximum Yaw Angle..... -55.0 °

Occupant Risk

Longitudinal OIV..... 10.8 ft/s (3.3 m/s)
 Lateral OIV..... 14.1 ft/s (4.3 m/s)
 Longitudinal RA..... -4.9 g
 Lateral RA..... 7.5 g
 THIV..... 25.9 ft/s (7.9 m/s)
 PHD..... 7.7 g
 ASI..... 0.64

Test Article Deflections

Static..... 0.5 ft (0.2 m)
 Dynamic..... 5.5 ft (1.7 m)
 Working Width..... 5.5 ft (1.7 m)
 Debris (lateral)..... 27.0 ft. (8.2 m)

Vehicle Damage

Vehicle Damage Scale..... 11-LFQ-4
 CDC..... 11LYAW3
 Maximum Intrusion..... 0.4 in. (10 mm)

Figure 3 Summary of Test 3-14

MASH 2016 Test 3-16 Summary

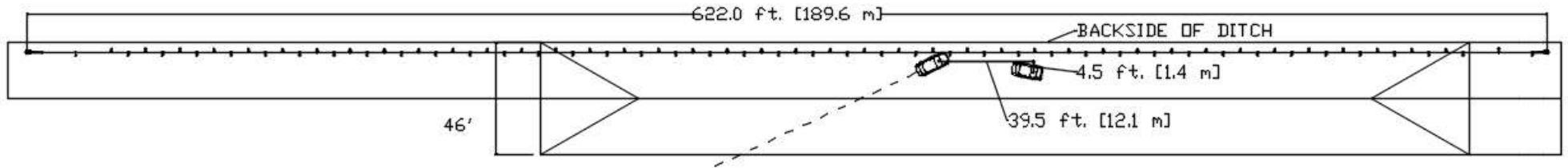
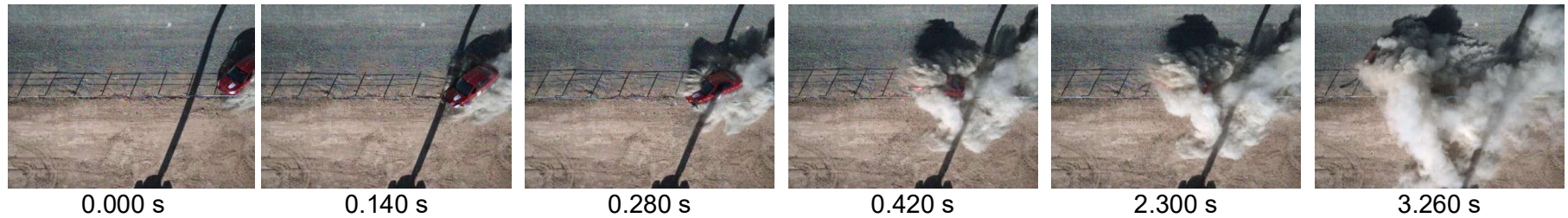

GENERAL INFORMATION		Impact Conditions		Occupant Risk	
Test Agency.....	Applus IDIADA KARCO	Impact Velocity.....	61.91 mph (99.63 km/h)	Longitudinal OIV.....	0.7 ft/s (0.2 m/s)
Test No.....	P39320-01	Impact Angle.....	25.0°	Lateral OIV.....	-3.3 ft/s (-1.0 m/s)
Test Designation.....	3-16	Location / Orientation.....	1.6 in. downstream from intended	Longitudinal RA.....	-11.2 g
Test Date.....	11/05/19	Impact Severity.....	55.6 kip-ft (75.4 kJ)	Lateral RA.....	5.1 g
TEST ARTICLE		Exit Conditions		Test Article Deflections	
Name / Model.....	TL-4 Cable Barrier System	Exit Velocity.....	14.04 mph (22.60 km/h)	Static.....	0.1 ft. (0.6 m)
Type.....	Longitudinal Barrier	Exit Angle.....	9.5°	Dynamic.....	2.1 ft. (0.6 m)
Installation Length.....	622.0 ft. (189.6 m)	Final Vehicle Position.....	39.5 ft. (12 m) Downstream	Working Width.....	3.0 ft (0.9 m)
Key Elements.....	Cable, Hair Pins, Lockplates		4.5 ft. (1.4 m) Right	Debris Field.....	No debris field
Road Surface.....	AASHTO M147-65 Grade B	Exit Box Criteria Met.....	Yes	Vehicle Damage	
Post Spacing.....	7.0 ft. (2.1 m)	Vehicle Snagging.....	Satisfactory	Vehicle Damage Scale.....	11-LFQ-1
TEST VEHICLE		Vehicle Pocketing.....	Satisfactory	CDC.....	11FDEK1 and 11LFES1
Type / Designation.....	1100C	Vehicle Stability.....	Satisfactory	Maximum Intrusion.....	0.4 in. (10 mm) at toepan
Year, Make, and Model.....	2009 Kia Rio	Maximum Roll Angle.....	-69.4 °		
Curb Mass.....	2,353.4 lbs (1,067.5 kg)	Maximum Pitch Angle.....	50.5 °		
Test Inertial Mass.....	2,431.7 lbs (1,103.0 kg)	Maximum Yaw Angle.....	-44.3 °		

Figure 2 Summary of Test 3-16

MASH Test 3-17 Summary



0.000 s

0.075 s

0.150 s

0.200 s

0.550 s

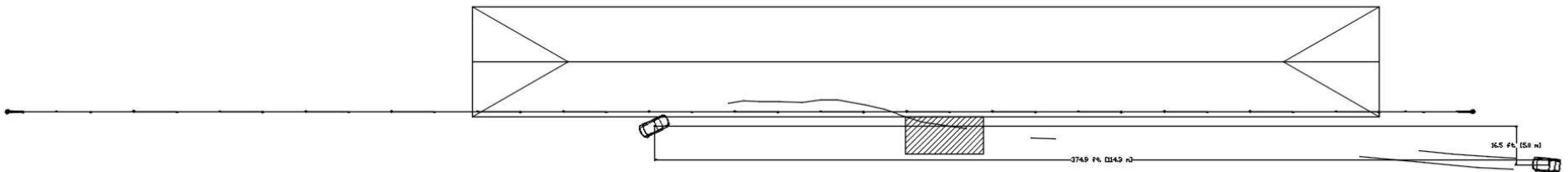

GENERAL INFORMATION

Test Agency..... Applus IDIADA KARCO Engineering
 Test No..... P38113-02
 Test Designation..... 3-17
 Test Date..... 04/30/18

TEST ARTICLE

Name / Model..... TL-4 Cable Barrier Sytem
 Type..... Longitudinal Barrier
 Installation Length..... 614.4 ft. (187.3 m)
 Key Elements..... hair pins,lock plate, cable
 Road Surface..... AASHTO M147-65 Grade B
 Post Spacing..... 18.0 ft. (5.5 m)

TEST VEHICLE

Type / Designation..... 1500A
 Year, Make, and Model..... 2012 Chevy Malibu
 Curb Mass..... 3,360.9 lbs (1,524.5 kg)
 Test Inertial Mass..... 3,244.0 lbs (1471.5 kg)
 Gross Static Mass..... 3,244.0 lbs (1471.5 kg)

Impact Conditions

Impact Velocity..... 64.73 mph (104.17 km/h)
 Impact Angle..... 24.6°
 Location / Orientation..... Midspan between posts
 Impact Severity..... 78.7 kip-ft (106.8 kJ)

Exit Conditions

Exit Velocity..... 33.31 mph (53.61 km/h)
 Exit Angle..... 6.5°
 Final Vehicle Position..... 374.9 ft. (114.3 m) Downstream
 16.5 ft. (5.0 m) Traffic Side
 Exit Box Criteria Met..... Yes
 Vehicle Snagging..... None
 Vehicle Pocketing..... Satisfactory
 Maximum Roll Angle..... -29.9 °
 Maximum Pitch Angle..... 15.3 °
 Maximum Yaw Angle..... 33.7 °

Occupant Risk

Longitudinal OIV..... 11.2 ft/s (3.4 m/s)
 Lateral OIV..... 17.1 ft/s (5.2 m/s)
 Longitudinal RA..... -2.3 g
 Lateral RA..... 4.0 g
 THIV..... 41.3 ft/s (12.6 m/s)
 PHD..... 4.0 g
 ASI..... 0.37

Test Article Deflections

Static..... 0.5 ft (0.2 m)
 Dynamic..... 13.5 ft (4.1 m)
 Working Width..... 13.5 ft (4.1 m)
 Debris (lateral)..... 23.0 ft. (7.0 m)

Vehicle Damage

Vehicle Damage Scale..... 11-LFQ-4
 CDC..... 11LYEW3
 Maximum Intrusion..... 0.7 in. (17 mm)

Figure 3 Summary of Test 3-17

MASH 2016 Test 3-18 Summary

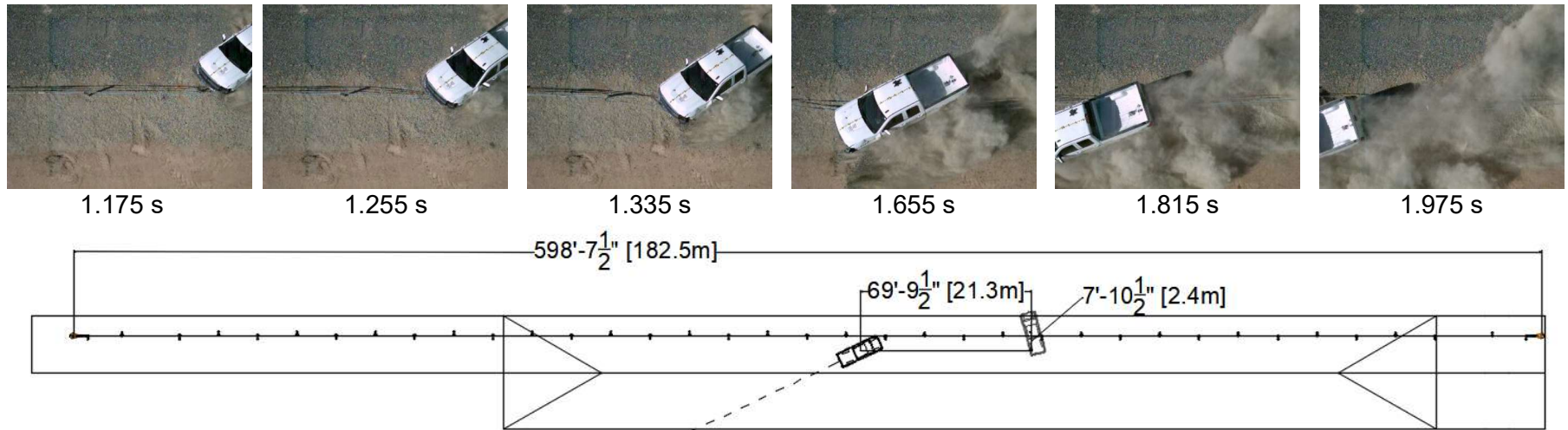

GENERAL INFORMATION	
Test Agency.....	Applus IDIADA KARCO
Test No.....	P40079-01
Test Designation.....	3-18
Test Date.....	04/23/20
TEST ARTICLE	
Name / Model.....	TL-4 Cable Barrier System
Type.....	Longitudinal Barrier
Installation Length.....	598.6 ft. (182.5 m)
Key Elements.....	Cable, Hair Pins, Lockplates
Road Surface.....	AASHTO M147-65 Grade B
Post Spacing.....	16.0 ft. (4.9 m)
TEST VEHICLE	
Type / Designation.....	2270P
Year, Make, and Model.....	2016 Chevrolet Silverado
Curb Mass.....	5,145.5 lbs (2,334.0 kg)
Test Inertial Mass.....	5,011.0 lbs (2,273.0 kg)
Gross Static Mass.....	5,011.0 lbs (2,273.0 kg)

Impact Conditions	
Impact Velocity.....	62.92 mph (101.26 km/h)
Impact Angle.....	25.1°
Location / Orientation.....	4.0 ft upstream from post 22
Impact Severity.....	119.3 kip-ft (161.8 kJ)
Exit Conditions	
Exit Velocity.....	N/A
Exit Angle.....	N/A
Final Vehicle Position.....	69.8 ft. (21.3 m) Downstream
	7.9 ft. (2.4 m) Left
Exit Box Criteria Met.....	Yes
Vehicle Snagging.....	Satisfactory
Vehicle Pocketing.....	Satisfactory
Vehicle Stability.....	Satisfactory
Maximum Roll Angle.....	-53.7°
Maximum Pitch Angle.....	44.0°
Maximum Yaw Angle.....	40.9°

Occupant Risk	
Longitudinal OIV.....	0.7 ft/s (0.2 m/s)
Lateral OIV.....	4.6 ft/s (1.4 m/s)
Longitudinal RA.....	-18.5 g
Lateral RA.....	-3.4 g
THIV.....	4.6 ft/s (1.4 m/s)
PHD.....	18.5 g
ASI.....	1.10
Test Article Deflections	
Static.....	0.3 ft. (0.9 m)
Dynamic.....	3.1 ft. (0.9 m)
Working Width.....	15.0 ft (4.6 m)
Debris Field.....	No debris field
Vehicle Damage	
Vehicle Damage Scale.....	11-LFQ-1
CDC.....	11FDEK1 and 11LFES1
Maximum Intrusion.....	0.7 in. (18 mm) at toe pan

Figure 2 Summary of Test 3-18

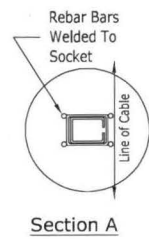
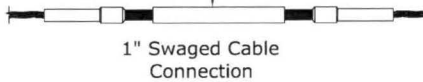
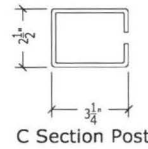
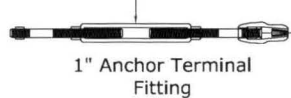
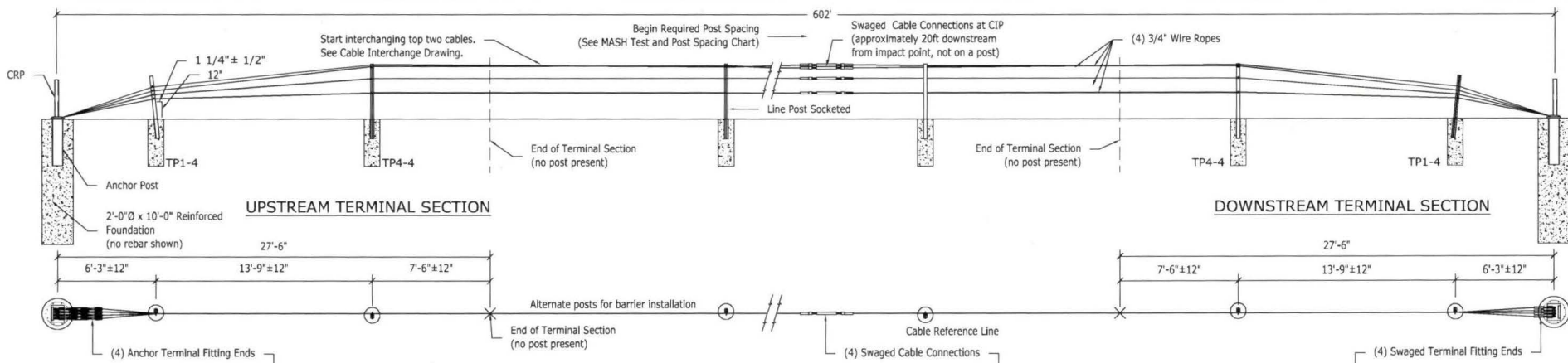

-10 °F	8600
0 °F	8200
10 °F	7800
20 °F	7400
30 °F	7000
40 °F	6600
50 °F	6200
60 °F	5800
70 °F	5400
80 °F	5000
90 °F	4600
100 °F	4200
110 °F	3800

*Allowable Deviation from Chart +/- 10%

TL-4 4 Cable MASH Test and Post Spacing Chart

MASH TEST	Line Post Spacing*
3-10	7'-0"
3-11	7'-0"
3-11	21'-0"
4-12**	21'-0"

*±6" post spacing tolerance
 **All tests are impacted near the midpoint of the installation at a 25° angle, except the 4-12 test, which is impacted at 15°.

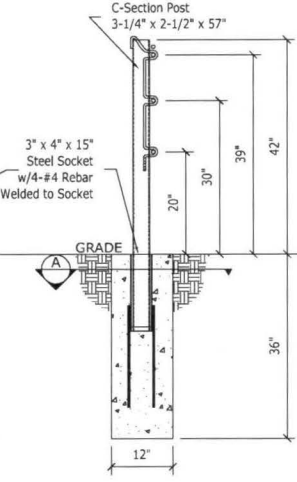
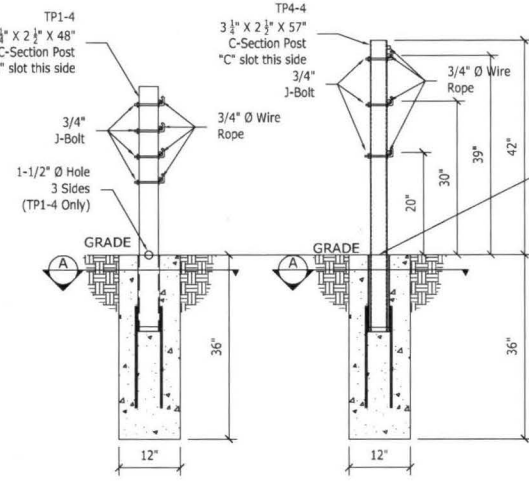
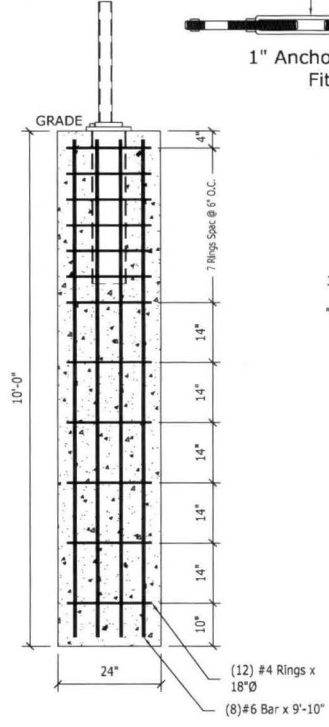

Cable Release & Anchor Post

Terminal Post (Welded Rebar Socket)

Terminal Post (Welded Rebar Socket)

Line Post (Welded Rebar Socket)



MASH 4 Cable Tests PROPRIETARY TO GIBRALTAR

TL-4 4 Cable System Layout

Gibraltar Cable Barrier Systems	
Scale: NTS	Date: 12-19-18
Layout: ANSI B	Drafter: JP

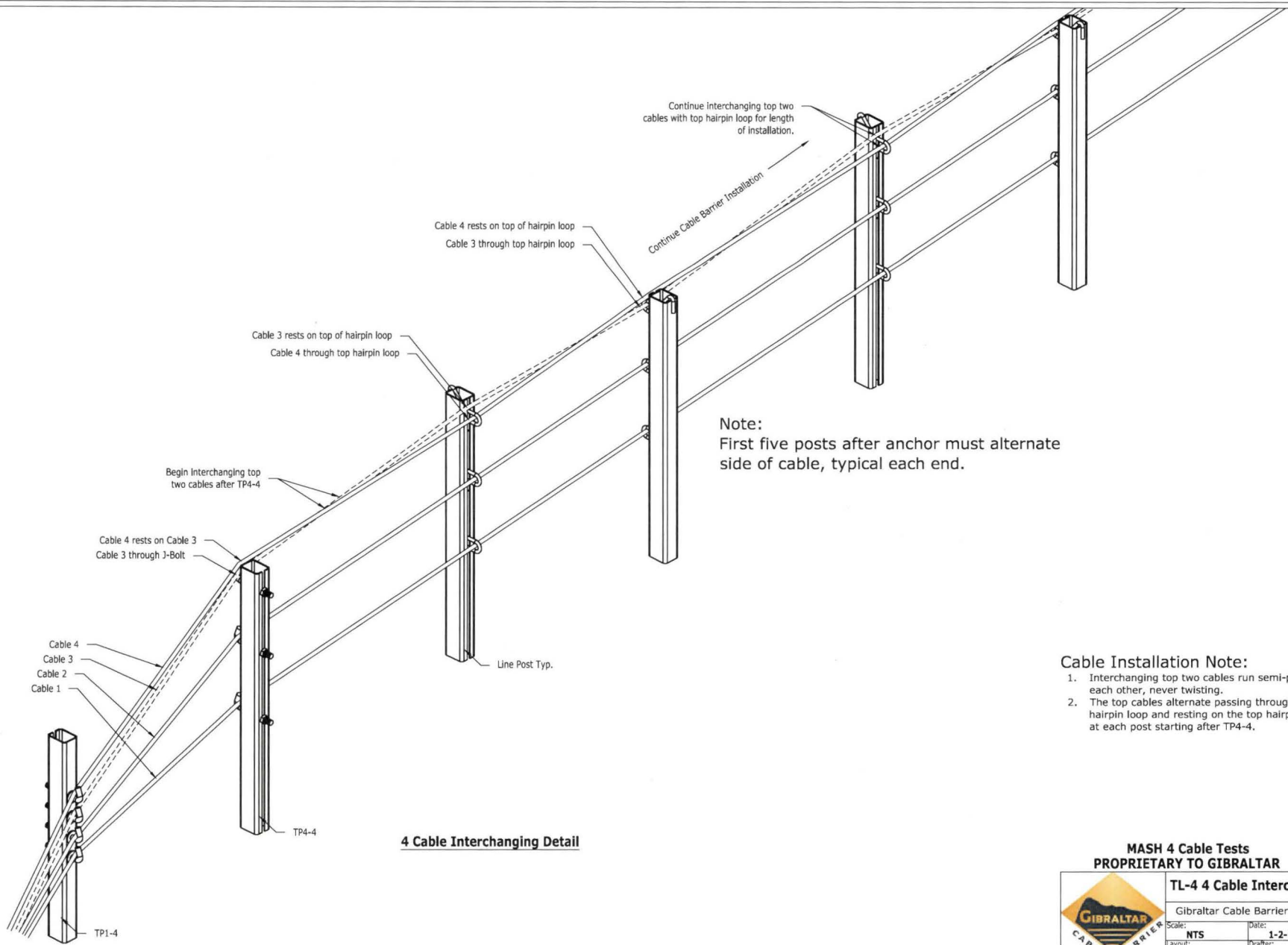

4 Cable Interchanging Detail

- Cable Installation Note:**
1. Interchanging top two cables run semi-parallel to each other, never twisting.
 2. The top cables alternate passing through the top hairpin loop and resting on the top hairpin loop at each post starting after TP4-4.

**MASH 4 Cable Tests
PROPRIETARY TO GIBRALTAR**

	TL-4 4 Cable Interchanging	
	Gibraltar Cable Barrier Systems	
	Scale: NTS	Date: 1-2-19
	Layout: ANSI B	Drafter: JP