



U.S. Department
of Transportation
**Federal Highway
Administration**

1200 New Jersey Ave., SE
Washington, D.C. 20590

February 6, 2012

In Reply Refer To:
HSST/B-229

Mr. Terry Colquhoun
Business Development Manager
Ingal Civil Products
57-65 Airds Road
Minto NSW 2566
Australia

Dear Mr. Colquhoun:

This letter is in response to your request for the Federal Highway Administration (FHWA) to review a roadside safety system for eligibility for reimbursement under the Federal-aid highway program.

Name of system:	Ezy-Guard W-Beam & Ezy-Guard Heavy Duty (HD) W-Beam Longitudinal Barrier Systems
Type of system:	Steel Post and W-beam roadside barrier
Test Level:	AASHTO Manual for Assessing Safety Hardware (MASH) Test Level 3 (TL3)
Testing conducted by:	Holmes Solutions Ltd
Task Force 13 Designator:	SGR44
Date of request:	July 14, 2011
Date initially acknowledged:	July 14, 2011
Date of completed package:	December 15, 2011

Decision:

The following device is eligible, with details provided below:

- Ezy-Guard W-Beam & Ezy-Guard Heavy Duty (HD) W-Beam
Longitudinal Barrier Systems

Based on a review of crash test results submitted by the manufacturer certifying the device described herein meets the crashworthiness criteria of the American Association of State Highway and Transportation Officials' Manual for Assessing Safety Hardware (MASH), the device is eligible for reimbursement under the Federal-aid highway program. Eligibility for reimbursement under the Federal-aid highway program does not establish approval or endorsement by the FHWA for any particular purpose or use.

FHWA: HSST: NArtimovicht: sf: x61331:2/1/12

File: s://directory folder/HSST/Artimovich/B-229_EZ Guard W-Beam & HD W-Beam
MASH.docx

cc: HSST (NArtimovich; JDewar)

The FHWA, the Department of Transportation, and the United States Government do not endorse products or services and the issuance of a reimbursement eligibility letter is not an endorsement of any product or service.

Requirements

Roadside safety devices should meet the guidelines contained in the MASH.

Description

A. Ingal EZY-Guard W-beam longitudinal barrier system:

The Ingal W-beam Guardrail system consists of W-beam guardrail attached to U section line posts via a slider bracket and attachment bolt. Line posts were driven 1170 millimeters into AASHTO M147-65 Standard Soil at 2000 millimeters centers. A total of 31 posts were installed with a length of need (LON) of 60.0 meters. The finished nominal rail height of the system was 790 millimeters (31 inches).

The guardrail consisted of Ingal Flexbeam G4 W-beam guard rail sections with a 4.0 meters net laying length (NLL). Flexbeam is a standard 12ga (2.7millimeters) galvanized W-beam section conforming to AASHTO M-180 Class A.

The slider brackets were manufactured from ductile iron and consisted of a 110 millimeters x 70 millimeters x 10 millimeters thick plate with a single M16 threaded hole. The slider plate fits down over the flanges of the line posts and is seated on the stopper plate. The threaded hole providing a mounting point for the guardrail via M16 post bolts.

The steel line posts were 5 lb/ft hot rolled high tensile steel fabricated in a U-section approximately 51 millimeters (2 inches) deep by 91 millimeters (3-1/2 inches) wide and 1980 millimeters (78 inches) long and hot dip galvanized. Posts incorporated a 90 millimeters x 10 millimeters x 3 millimeters mild steel stopper plate welded across the U-section 210 millimeters (8 inches) from the top edge for seating of the slider bracket.

Guardrail sections were joined together with standard M16 x 32 galvanized mushroom head splice bolts and M16 oversize nuts. Guardrail sections were fixed to the slider brackets with a single machined steel M16 bolt with oversize head.

An ET-2000 Plus Steel Yielding Terminal Post System, tested and approved to NCHRP 350 TL-3, was installed at each end of the barrier LON. Each terminal end consisted of an extruder head assembly, eight I-section line posts at 1905 millimeters centers, King Block 190 millimeters plastic block-outs, and four lengths of Flexbeam G4 W-beam guardrail.

The terminal ends and line post for both Test 3-10 and Test 3-11 longitudinal W-beam barrier tests were embedded in AASHTO M 147-65 'Standard' soil.

Design details are provided as enclosure to this correspondence.

B. Ingal EZY-Guard Heavy Duty W-beam longitudinal barrier system:

This system consists of W-beam guardrail attached to EZY-Guard Heavy Duty Z-section line post via a guardrail carriage system and attachment bolt. The line posts were driven 1080 millimeters (42.5 inches) into AASHTO M147-65 Standard Soil at 2.0 meters (6.6 feet) centers. A total of 31 posts were installed giving a test installation LON of 60.0 meters (197 feet). The finished nominal rail height of the system was 730 millimeters (28.7 inches), with all steel line posts finishing below the top of the rail at a height of 720 millimeters (28.3 inches). Each end of the length of need was terminated with an ET-2000 Plus Steel Yielding Terminal Post System, each with an installed length of 15.24 meters (50 feet). The overall test installation length was 90.8 meters (298 feet).

The steel line posts were manufactured from Grade 300 steel fabricated into a 'Z' section approximately 60 millimeters (2.5 inches) wide by 140 millimeters (5.5 inches) deep and 1800 millimeters (71 inches) long. All line posts were hot dip galvanized. A series of three tabs were formed proud into the front face of the post. The upper two tabs formed transversely across the tab face were placed above the resting position of the carriage. A cavity formed in the carriage allowed it to pass over the tabs without fouling. The third tab was offset on the face of the post and made sufficiently proud so as to form a resting stop for the guardrail carriage. The upper tab was 7.5 millimeters (0.3 inches) in thickness and located 17.5 millimeters (0.7 inches) from the top of the post. The middle tab had a thickness of 4 millimeters (0.2 inches) and was located 73 millimeters (2.9 inches) from the top of the post. A third tab was installed 185 millimeters (7.3 inches) from the top of the post and formed the resting stop for the guardrail carriage.

The guardrail consisted of Ingal Flexbeam G4 W-beam guard rail sections with a 4.0 m (13 feet) net laying length (NLL). Flexbeam is a standard 12g galvanized Wbeam section conforming to AASHTO M-180 Class A.

The guardrail carriages were manufactured from ductile iron and consisted of a 85 millimeters x 55 millimeters x 60 millimeters (3.3 inches x 2.1 inches x 2.3 inches) thick section with a single M16 threaded hole. The guardrail carriages fitted over the flanges of the line posts and were seated on the third tab (lower tab) formed in the steel line posts. The threaded hole provided the mounting point for the guardrail via a proprietary M16 carriage bolt.

Guardrail sections were joined together with standard M16 x 32 Galvanized mushroom head splice bolts and M16 oversize nuts. Guardrail sections were fixed to posts via the guardrail carriages, using a single proprietary M16 bolt with an oversize domed head.

An ET-2000 Plus Steel Yielding Terminal Post System, tested and approved to NCHRP 350 TL-3, was installed at each end of the barrier LON. Each terminal end consisted of an extruder head assembly, eight I-section line posts at 1905 mm centers, King Block 190 mm plastic block-outs, and four lengths of Flexbeam G4 W-beam guardrail. The nominal finished installed height of the terminal ends was 730 millimeters (28 inches), directly matching the installed height of the guardrail system.

The terminal ends and line post for both Test 3-10 and Test 3-11 longitudinal Wbeam barrier tests were embedded in AASHTO M 147-65 'Standard' soil.

Design details are provided as enclosure to this correspondence.

Findings

A. Ingal EZY-Guard W-beam longitudinal barrier system:

The 820C test vehicle (test vehicle) impacted the installation 0.95 meters (3.1 feet) upstream of line post 11 at an angle of 20 degrees and a velocity of 101.7 kph. The Ingal W-beam barrier system, consisting of fifteen 4-meter (13.1 feet) lengths of Wbeam guardrail supported on thirty-one 5 lb/ft U-section steel posts and slider brackets installed at a 2.0 meter (6.5 feet) spacing, successfully contained and redirected a 820C test vehicle impacting the test article at 20 degrees with a velocity of 101.7 kph. The majority of high tensile posts in the impact zone fractured upon collision with the vehicle. The larger detached post fragments were mainly scattered along the hazard side of the barrier installation, however a post fragment was observed on the traffic side of the barrier. This indicates that the trajectory of the fractured posts is uncontrolled and presents an undue risk to other traffic, pedestrians and work zone personnel. Minor penetration and deformation of the occupant compartment occurred as the result of a fractured post. Whilst the vehicle damage was within assessment limitations, the uncontrolled trajectory of the fractured posts presents an undue hazard to the vehicle occupants. The vehicle remained upright during and after the impact and vehicle stability was considered satisfactory. Occupant risk factors satisfied the test criteria and the vehicle exit trajectory remained within acceptable limits.

Use of the 820C test vehicle during the re-write timeframe of NCHRP Report 350 update (i.e., MASH) was allowed in lieu of the 1100C small car. In this particular case, Holmes Solutions Crash Test Report 102350.03-4 dated May 2009 used a proper 820C test vehicle that met the NCHRP Report 350 criteria. In addition after a full review of the test report, there is no reason to believe the MASH 1100C test vehicle at the higher angle would fail this test.

The 2270P test vehicle (test vehicle) impacted the Critical Impact Point (CIP) 1.48 meters (4.85 feet) upstream of line post 11 at a velocity of 99.7 kph and an angle of 25 degrees before impacting on post 11 with the left front wheel causing the post to fracture at ground level. The Ingal W-beam barrier system, consisting of fifteen 4-metre lengths of Wbeam guardrail supported on thirty-one 5 lb/ft U-section steel posts and slider brackets installed at 2.0 spacing, successfully contained and redirected a 2270P test vehicle impacting the test article at 25 degrees with a velocity of 99.7 kph. The majority of high tensile posts in the impact zone fractured upon collision with the vehicle. The detached post fragments were scattered along the hazard side and traffic side of the barrier installation. This indicates that the trajectory of the fractured posts is uncontrolled and presents an undue risk to other traffic, pedestrians and work zone personnel. There were no deformations recorded in the occupant compartment and the vehicle remained upright during and after the impact. The vehicle trajectory behind the test article remained straight and stable.

Testing Summary sheets are provided as enclosures to this correspondence.

B. Ingal EZY-Guard Heavy Duty W-beam longitudinal barrier system:

The Ingal EZY-Guard Heavy Duty W-beam barrier system when installed at a nominal height of 730 millimeters (28 inches), successfully contained and redirected a 1100C test

vehicle impacting the test article at 24.9 degrees with a velocity of 101.8 kph. No debris or detached elements penetrated or showed potential to penetrate the occupant compartment. No fragments were distributed outside of the vehicle trajectory and therefore did not present any undue hazard to other traffic, pedestrians or work zone personnel. The vehicle remained upright during and after the impact and vehicle stability was considered satisfactory. Occupant risk factors satisfied the test criteria and the vehicle exit trajectory remained within acceptable limits.

The Ingal EZY-Guard Heavy Duty W-beam barrier system when installed at a nominal height of 730 millimeters (28 inches) successfully contained and redirected a 2270P test vehicle impacting the test article at 25 degrees with a velocity of 99.0 kph. No debris or detached elements penetrated or showed potential to penetrate the occupant compartment. No fragments were distributed outside of the vehicle trajectory and therefore did not present any undue hazard to other traffic, pedestrians or work zone personnel. The vehicle remained upright during and after the impact and vehicle stability was considered satisfactory. Occupant risk factors satisfied the test criteria and the vehicle exit trajectory remained within acceptable limits.

Testing Summary sheets are provided as enclosures to this correspondence.

Therefore, the systems described and detailed in this correspondence and the crash test reports are eligible for reimbursement and may be installed under the range of conditions tested.

Please note the following standard provisions that apply to FHWA eligibility letters:

- This letter provides a AASHTO/ARTBA/AGC Task Force 13 designator that should be used for the purpose of the creation of a new and/or the update of existing Task Force 13 drawing for posting on the on-line 'Guide to Standardized Highway Barrier Hardware' currently referenced in AASHTO Roadside Design Guide.
- This finding of eligibility is limited to the crashworthiness characteristics of the systems and does not cover their structural features, nor conformity with the Manual on Uniform Traffic Control Devices.
- Any changes that may influence the crashworthiness of the system will require a new reimbursement eligibility letter.
- Should the FHWA discover that the qualification testing was flawed, that in-service performance reveals safety problems, or that the system is significantly different from the version that was crash tested, we reserve the right to modify or revoke this letter.
- You will be expected to supply potential users with sufficient information on design and installation requirements to ensure proper performance.
- You will be expected to certify to potential users that the hardware furnished has the same chemistry, mechanical properties, and geometry as that submitted for review, and that it will meet the crashworthiness requirements of the Manual for Assessing Safety Hardware.
- To prevent misunderstanding by others, this letter of eligibility is designated as number B-229 and shall not be reproduced except in full. This letter and the test documentation upon which it is based are public information. All such letters and documentation may be reviewed at our office upon request.

- This letter shall not be construed as authorization or consent by the FHWA to use, manufacture, or sell any patented system for which the applicant is not the patent holder. The finding of eligibility is limited to the crashworthiness characteristics of the candidate system, and the FHWA is neither prepared nor required to become involved in issues concerning patent law. Patent issues, if any, are to be resolved by the applicant.
- The Ezy-Guard W-Beam & Ezy-Guard Heavy Duty (HD) W-Beam Longitudinal Barrier Systems are patented products and considered proprietary. If proprietary systems are specified by a highway agency for use on Federal-aid projects: (a) they must be supplied through competitive bidding with equally suitable unpatented items; (b) the highway agency must certify that they are essential for synchronization with the existing highway facilities or that no equally suitable alternative exists; or (c) they must be used for research or for a distinctive type of construction on relatively short sections of road for experimental purposes. Our regulations concerning proprietary products are contained in Title 23, Code of Federal Regulations, Section 635.411.

Sincerely yours,

Michael S. Griffith
Director, Office of Safety Technologies
Office of Safety

Enclosures



U.S. Department
of Transportation
**Federal Highway
Administration**

1200 New Jersey Ave., SE
Washington, D.C. 20590

February 6, 2012

In Reply Refer To:
HSST/B-229

Mr. Terry Colquhoun
Business Development Manager
Ingal Civil Products
57-65 Airds Road
Minto NSW 2566
Australia

Dear Mr. Colquhoun:

This letter is in response to your request for the Federal Highway Administration (FHWA) to review a roadside safety system for eligibility for reimbursement under the Federal-aid highway program.

Name of system:	Ezy-Guard W-Beam & Ezy-Guard Heavy Duty (HD) W-Beam Longitudinal Barrier Systems
Type of system:	Steel Post and W-beam roadside barrier
Test Level:	AASHTO Manual for Assessing Safety Hardware (MASH) Test Level 3 (TL3)
Testing conducted by:	Holmes Solutions Ltd
Task Force 13 Designator:	SGR44
Date of request:	July 14, 2011
Date initially acknowledged:	July 14, 2011
Date of completed package:	December 15, 2011

Decision:

The following device is eligible, with details provided below:

- Ezy-Guard W-Beam & Ezy-Guard Heavy Duty (HD) W-Beam
Longitudinal Barrier Systems

Based on a review of crash test results submitted by the manufacturer certifying the device described herein meets the crashworthiness criteria of the American Association of State Highway and Transportation Officials' Manual for Assessing Safety Hardware (MASH), the device is eligible for reimbursement under the Federal-aid highway program. Eligibility for reimbursement under the Federal-aid highway program does not establish approval or endorsement by the FHWA for any particular purpose or use.

The FHWA, the Department of Transportation, and the United States Government do not endorse products or services and the issuance of a reimbursement eligibility letter is not an endorsement of any product or service.

Requirements

Roadside safety devices should meet the guidelines contained in the MASH.

Description

A. Ingal EZY-Guard W-beam longitudinal barrier system:

The Ingal W-beam Guardrail system consists of W-beam guardrail attached to U section line posts via a slider bracket and attachment bolt. Line posts were driven 1170 millimeters into AASHTO M147-65 Standard Soil at 2000 millimeters centers. A total of 31 posts were installed with a length of need (LON) of 60.0 meters. The finished nominal rail height of the system was 790 millimeters (31 inches).

The guardrail consisted of Ingal Flexbeam G4 W-beam guard rail sections with a 4.0 meters net laying length (NLL). Flexbeam is a standard 12ga (2.7millimeters) galvanized W-beam section conforming to AASHTO M-180 Class A.

The slider brackets were manufactured from ductile iron and consisted of a 110 millimeters x 70 millimeters x 10 millimeters thick plate with a single M16 threaded hole. The slider plate fits down over the flanges of the line posts and is seated on the stopper plate. The threaded hole providing a mounting point for the guardrail via M16 post bolts.

The steel line posts were 5 lb/ft hot rolled high tensile steel fabricated in a U-section approximately 51 millimeters (2 inches) deep by 91 millimeters (3-1/2 inches) wide and 1980 millimeters (78 inches) long and hot dip galvanized. Posts incorporated a 90 millimeters x 10 millimeters x 3 millimeters mild steel stopper plate welded across the U-section 210 millimeters (8 inches) from the top edge for seating of the slider bracket.

Guardrail sections were joined together with standard M16 x 32 galvanized mushroom head splice bolts and M16 oversize nuts. Guardrail sections were fixed to the slider brackets with a single machined steel M16 bolt with oversize head.

An ET-2000 Plus Steel Yielding Terminal Post System, tested and approved to NCHRP 350 TL-3, was installed at each end of the barrier LON. Each terminal end consisted of an extruder head assembly, eight I-section line posts at 1905 millimeters centers, King Block 190 millimeters plastic block-outs, and four lengths of Flexbeam G4 W-beam guardrail.

The terminal ends and line post for both Test 3-10 and Test 3-11 longitudinal W-beam barrier tests were embedded in AASHTO M 147-65 'Standard' soil.

Design details are provided as enclosure to this correspondence.

B. Ingal EZY-Guard Heavy Duty W-beam longitudinal barrier system:

This system consists of W-beam guardrail attached to EZY-Guard Heavy Duty Z-section line post via a guardrail carriage system and attachment bolt. The line posts were driven 1080 millimeters (42.5 inches) into AASHTO M147-65 Standard Soil at 2.0 meters (6.6 feet) centers. A total of 31 posts were installed giving a test installation LON of 60.0 meters (197 feet). The finished nominal rail height of the system was 730 millimeters (28.7 inches), with all steel line posts finishing below the top of the rail at a height of 720 millimeters (28.3 inches). Each end of the length of need was terminated with an ET-2000 Plus Steel Yielding Terminal Post System, each with an installed length of 15.24 meters (50 feet). The overall test installation length was 90.8 meters (298 feet).

The steel line posts were manufactured from Grade 300 steel fabricated into a 'Z' section approximately 60 millimeters (2.5 inches) wide by 140 millimeters (5.5 inches) deep and 1800 millimeters (71 inches) long. All line posts were hot dip galvanized. A series of three tabs were formed proud into the front face of the post. The upper two tabs formed transversely across the tab face were placed above the resting position of the carriage. A cavity formed in the carriage allowed it to pass over the tabs without fouling. The third tab was offset on the face of the post and made sufficiently proud so as to form a resting stop for the guardrail carriage. The upper tab was 7.5 millimeters (0.3 inches) in thickness and located 17.5 millimeters (0.7 inches) from the top of the post. The middle tab had a thickness of 4 millimeters (0.2 inches) and was located 73 millimeters (2.9 inches) from the top of the post. A third tab was installed 185 millimeters (7.3 inches) from the top of the post and formed the resting stop for the guardrail carriage.

The guardrail consisted of Ingal Flexbeam G4 W-beam guard rail sections with a 4.0 m (13 feet) net laying length (NLL). Flexbeam is a standard 12g galvanized Wbeam section conforming to AASHTO M-180 Class A.

The guardrail carriages were manufactured from ductile iron and consisted of a 85 millimeters x 55 millimeters x 60 millimeters (3.3 inches x 2.1 inches x 2.3 inches) thick section with a single M16 threaded hole. The guardrail carriages fitted over the flanges of the line posts and were seated on the third tab (lower tab) formed in the steel line posts. The threaded hole provided the mounting point for the guardrail via a proprietary M16 carriage bolt.

Guardrail sections were joined together with standard M16 x 32 Galvanized mushroom head splice bolts and M16 oversize nuts. Guardrail sections were fixed to posts via the guardrail carriages, using a single proprietary M16 bolt with an oversize domed head.

An ET-2000 Plus Steel Yielding Terminal Post System, tested and approved to NCHRP 350 TL-3, was installed at each end of the barrier LON. Each terminal end consisted of an extruder head assembly, eight I-section line posts at 1905 mm centers, King Block 190 mm plastic block-outs, and four lengths of Flexbeam G4 W-beam guardrail. The nominal finished installed height of the terminal ends was 730 millimeters (28 inches), directly matching the installed height of the guardrail system.

The terminal ends and line post for both Test 3-10 and Test 3-11 longitudinal Wbeam barrier tests were embedded in AASHTO M 147-65 'Standard' soil.

Design details are provided as enclosure to this correspondence.

Findings

A. Ingal EZY-Guard W-beam longitudinal barrier system:

The 820C test vehicle (test vehicle) impacted the installation 0.95 meters (3.1 feet) upstream of line post 11 at an angle of 20 degrees and a velocity of 101.7 kph. The Ingal W-beam barrier system, consisting of fifteen 4-meter (13.1 feet) lengths of Wbeam guardrail supported on thirty-one 5 lb/ft U-section steel posts and slider brackets installed at a 2.0 meter (6.5 feet) spacing, successfully contained and redirected a 820C test vehicle impacting the test article at 20 degrees with a velocity of 101.7 kph. The majority of high tensile posts in the impact zone fractured upon collision with the vehicle. The larger detached post fragments were mainly scattered along the hazard side of the barrier installation, however a post fragment was observed on the traffic side of the barrier. This indicates that the trajectory of the fractured posts is uncontrolled and presents an undue risk to other traffic, pedestrians and work zone personnel. Minor penetration and deformation of the occupant compartment occurred as the result of a fractured post. Whilst the vehicle damage was within assessment limitations, the uncontrolled trajectory of the fractured posts presents an undue hazard to the vehicle occupants. The vehicle remained upright during and after the impact and vehicle stability was considered satisfactory. Occupant risk factors satisfied the test criteria and the vehicle exit trajectory remained within acceptable limits.

Use of the 820C test vehicle during the re-write timeframe of NCHRP Report 350 update (i.e., MASH) was allowed in lieu of the 1100C small car. In this particular case, Holmes Solutions Crash Test Report 102350.03-4 dated May 2009 used a proper 820C test vehicle that met the NCHRP Report 350 criteria. In addition after a full review of the test report, there is no reason to believe the MASH 1100C test vehicle at the higher angle would fail this test.

The 2270P test vehicle (test vehicle) impacted the Critical Impact Point (CIP) 1.48 meters (4.85 feet) upstream of line post 11 at a velocity of 99.7 kph and an angle of 25 degrees before impacting on post 11 with the left front wheel causing the post to fracture at ground level. The Ingal W-beam barrier system, consisting of fifteen 4-metre lengths of Wbeam guardrail supported on thirty-one 5 lb/ft U-section steel posts and slider brackets installed at 2.0 spacing, successfully contained and redirected a 2270P test vehicle impacting the test article at 25 degrees with a velocity of 99.7 kph. The majority of high tensile posts in the impact zone fractured upon collision with the vehicle. The detached post fragments were scattered along the hazard side and traffic side of the barrier installation. This indicates that the trajectory of the fractured posts is uncontrolled and presents an undue risk to other traffic, pedestrians and work zone personnel. There were no deformations recorded in the occupant compartment and the vehicle remained upright during and after the impact. The vehicle trajectory behind the test article remained straight and stable.

Testing Summary sheets are provided as enclosures to this correspondence.

B. Ingal EZY-Guard Heavy Duty W-beam longitudinal barrier system:

The Ingal EZY-Guard Heavy Duty W-beam barrier system when installed at a nominal height of 730 millimeters (28 inches), successfully contained and redirected a 1100C test

vehicle impacting the test article at 24.9 degrees with a velocity of 101.8 kph. No debris or detached elements penetrated or showed potential to penetrate the occupant compartment. No fragments were distributed outside of the vehicle trajectory and therefore did not present any undue hazard to other traffic, pedestrians or work zone personnel. The vehicle remained upright during and after the impact and vehicle stability was considered satisfactory. Occupant risk factors satisfied the test criteria and the vehicle exit trajectory remained within acceptable limits.

The Ingal EZY-Guard Heavy Duty W-beam barrier system when installed at a nominal height of 730 millimeters (28 inches) successfully contained and redirected a 2270P test vehicle impacting the test article at 25 degrees with a velocity of 99.0 kph. No debris or detached elements penetrated or showed potential to penetrate the occupant compartment. No fragments were distributed outside of the vehicle trajectory and therefore did not present any undue hazard to other traffic, pedestrians or work zone personnel. The vehicle remained upright during and after the impact and vehicle stability was considered satisfactory. Occupant risk factors satisfied the test criteria and the vehicle exit trajectory remained within acceptable limits.

Testing Summary sheets are provided as enclosures to this correspondence.

Therefore, the systems described and detailed in this correspondence and the crash test reports are eligible for reimbursement and may be installed under the range of conditions tested.

Please note the following standard provisions that apply to FHWA eligibility letters:

- This letter provides a AASHTO/ARTBA/AGC Task Force 13 designator that should be used for the purpose of the creation of a new and/or the update of existing Task Force 13 drawing for posting on the on-line 'Guide to Standardized Highway Barrier Hardware' currently referenced in AASHTO Roadside Design Guide.
- This finding of eligibility is limited to the crashworthiness characteristics of the systems and does not cover their structural features, nor conformity with the Manual on Uniform Traffic Control Devices.
- Any changes that may influence the crashworthiness of the system will require a new reimbursement eligibility letter.
- Should the FHWA discover that the qualification testing was flawed, that in-service performance reveals safety problems, or that the system is significantly different from the version that was crash tested, we reserve the right to modify or revoke this letter.
- You will be expected to supply potential users with sufficient information on design and installation requirements to ensure proper performance.
- You will be expected to certify to potential users that the hardware furnished has the same chemistry, mechanical properties, and geometry as that submitted for review, and that it will meet the crashworthiness requirements of the Manual for Assessing Safety Hardware.
- To prevent misunderstanding by others, this letter of eligibility is designated as number B-229 and shall not be reproduced except in full. This letter and the test documentation upon which it is based are public information. All such letters and documentation may be reviewed at our office upon request.

- This letter shall not be construed as authorization or consent by the FHWA to use, manufacture, or sell any patented system for which the applicant is not the patent holder. The finding of eligibility is limited to the crashworthiness characteristics of the candidate system, and the FHWA is neither prepared nor required to become involved in issues concerning patent law. Patent issues, if any, are to be resolved by the applicant.
- The Ezy-Guard W-Beam & Ezy-Guard Heavy Duty (HD) W-Beam Longitudinal Barrier Systems are patented products and considered proprietary. If proprietary systems are specified by a highway agency for use on Federal-aid projects: (a) they must be supplied through competitive bidding with equally suitable unpatented items; (b) the highway agency must certify that they are essential for synchronization with the existing highway facilities or that no equally suitable alternative exists; or (c) they must be used for research or for a distinctive type of construction on relatively short sections of road for experimental purposes. Our regulations concerning proprietary products are contained in Title 23, Code of Federal Regulations, Section 635.411.

Sincerely yours,



Michael S. Griffith

Director, Office of Safety Technologies
Office of Safety

Enclosures

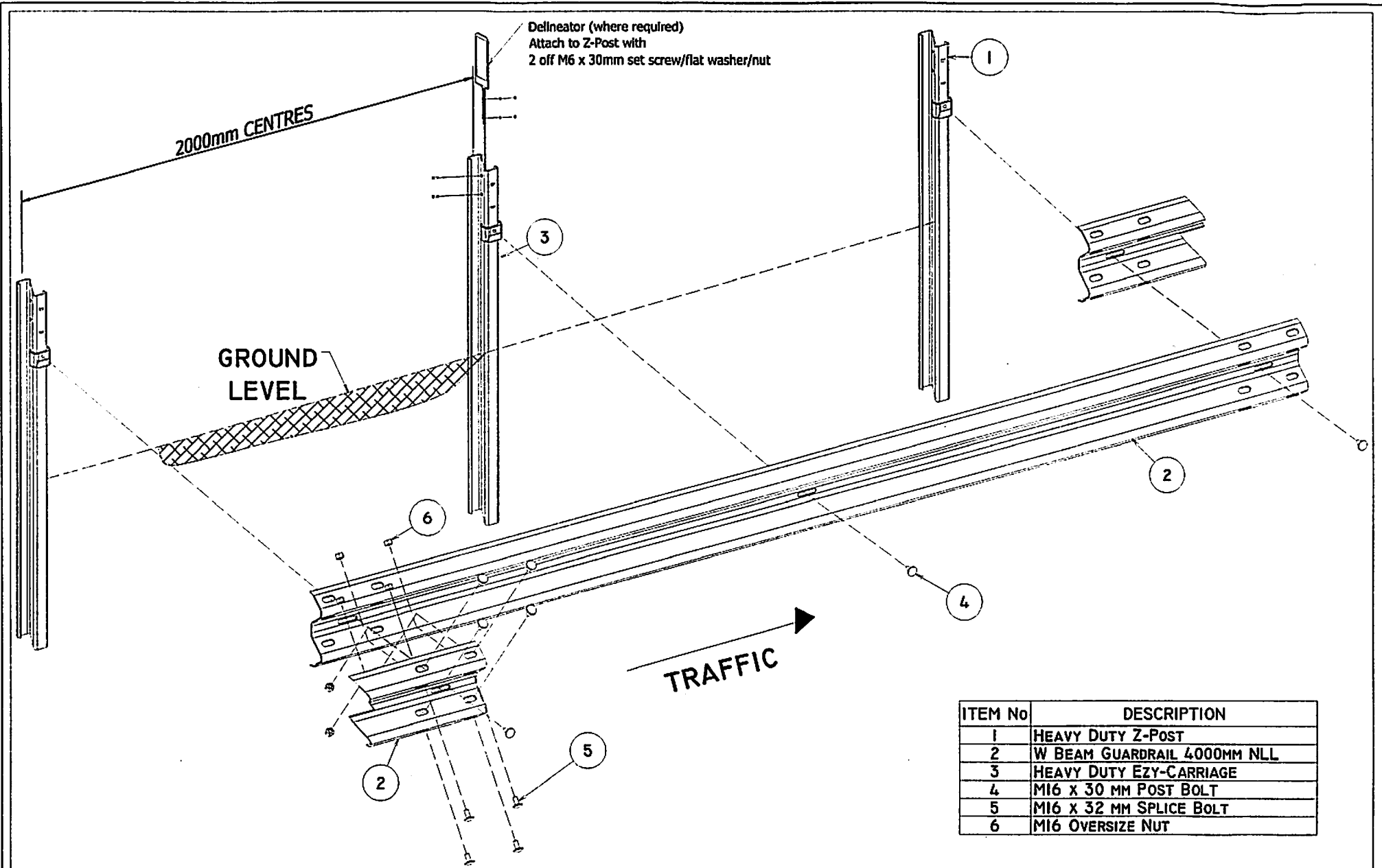

ITEM No	DESCRIPTION
1	HEAVY DUTY Z-POST
2	W BEAM GUARDRAIL 4000MM NLL
3	HEAVY DUTY EZY-CARRIAGE
4	MI6 X 30 MM POST BOLT
5	MI6 X 32 MM SPLICE BOLT
6	MI6 OVERSIZE NUT

REV	DATE	DESCRIPTION	DRAWN	EMBED	APPROVED	DRAWING NUMBER	REFERENCE DRAWINGS	DRAWN	DATE	SCALE	SIZE	PROJECT	DRAWING NO
1	30/03/2011	ISSUED FOR ESTIMATION	DM	TC				DM	30/03/2011	1:1	A1	EZY-GUARD HEAVY DUTY	EZY-HD-007
2	30/03/2011	ISSUED FOR ESTIMATION	DM	TC				DM	30/03/2011	1:1	A1	ASSEMBLY DETAIL - SHEET 1 of 2	EZY-HD-007



ROYAL CIVIL PRODUCTS
STYLES APONS ROAD
MURTEL, VIC 31
AUSTRALIA 3166
PH: +61 2 9627 3333
FAX: +61 2 9627 3300
www.rcp.com.au

<p>DRAWING AND CONTENTS ARE COPYRIGHT TO ROYAL CIVIL PRODUCTS AND CAN ONLY BE USED WITH EXPRESS WRITTEN CONSENT FROM ROYAL CIVIL PRODUCTS</p>	<p>PROJECT EZY-GUARD HEAVY DUTY</p> <p>TITLE ASSEMBLY DETAIL - SHEET 1 of 2</p>	<p>ROYAL CIVIL PRODUCTS REFERENCE NO</p> <p>DRAWING NO EZY-HD-007</p> <p>REV 0</p>
---	---	--

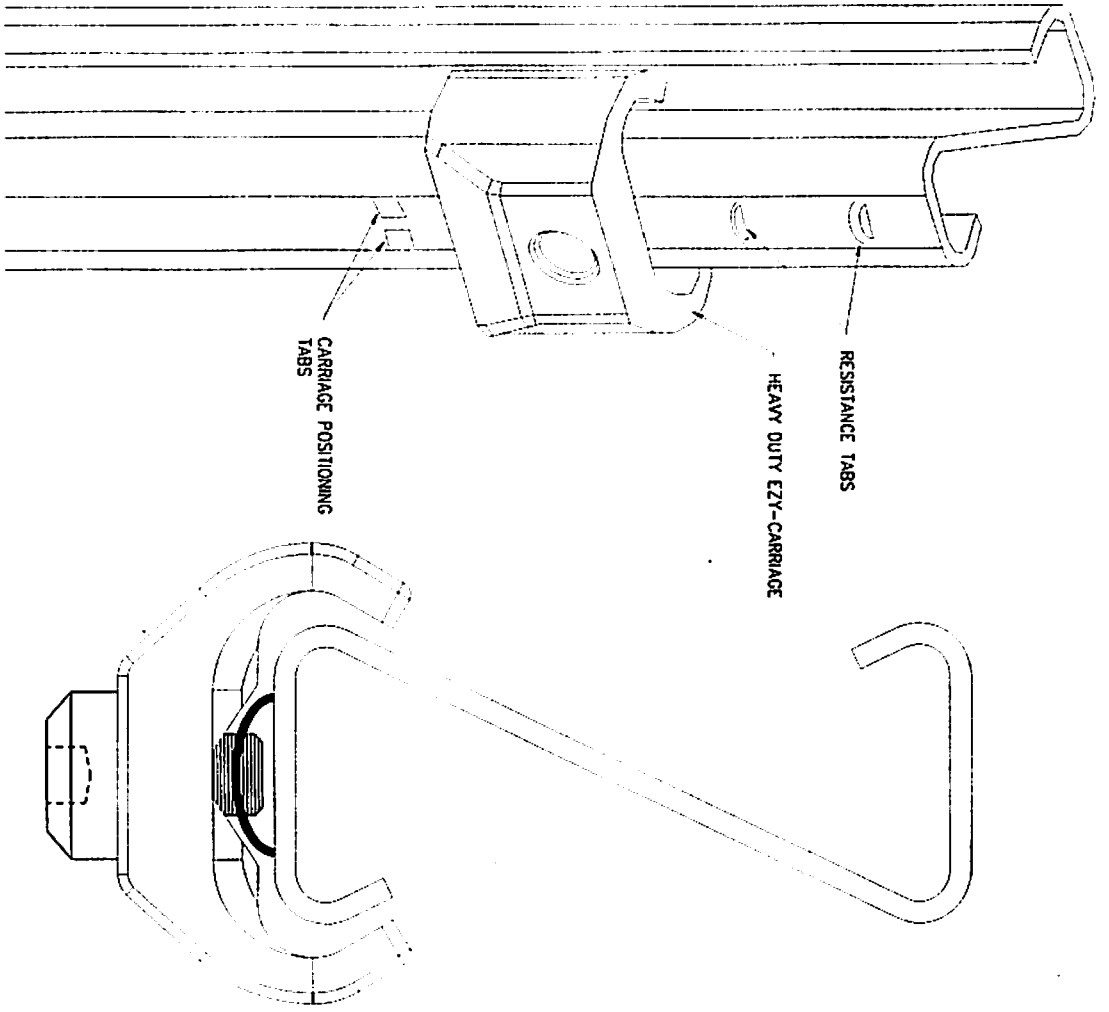

Z-POST & CARRIAGE ASSEMBLY
ISOMETRIC VIEW

Z-POST & CARRIAGE ASSEMBLY
PLAN VIEW

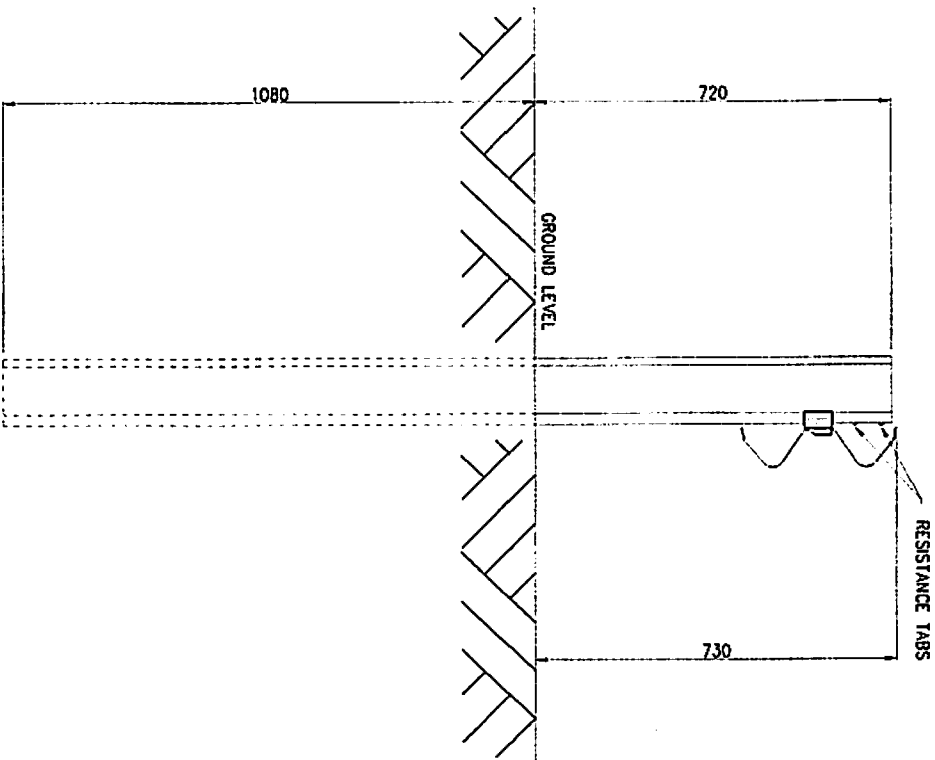

Z-POST & CARRIAGE ASSEMBLY
SIDE VIEW

REVISIONS		REFERENCES		DATE		 <small> 2145 GUN PROTECTIVE SYSTEMS, INC. 10000 W. 11TH AVE. #200 DENVER, CO 80233 </small>	<small> DRAWING AND CONTENTS ARE CONSIDERED TO BE THE PROPERTY AND CAN ONLY BE USED FOR THE PURPOSES AUTHORIZED BY THE ORIGINAL DRAWING. </small>	PROJECT EZY-GUARD HEAVY DUTY ASSEMBLY DETAIL - SHEET 2 of 2	DRAWING NO. EZY-HD-008
REV	DATE	DESCRIPTION	BY	DATE	SCALE				
1	03/03/2011	ISSUE FOR CONSTRUCTION	DR	03/03/2011	AS SHOWN				
2	03/03/2011	REVISED TO ADD THE RESISTANCE TABS	DR	03/03/2011	AS SHOWN				

Test Summary

Test No. 102350.97.05.1.5.2

Holmes Solutions Limited, New Zealand

11 January 2010

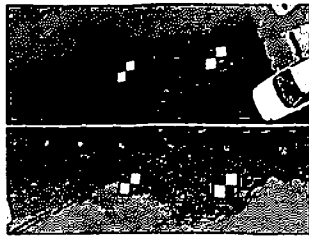

0.0 sec

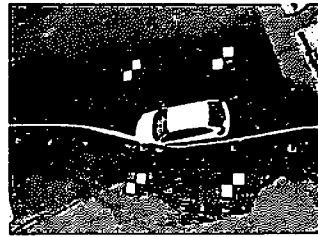

0.25 sec

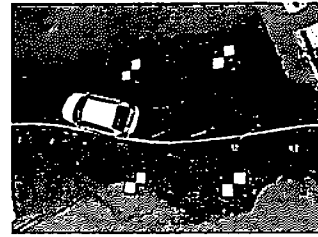

0.50 sec

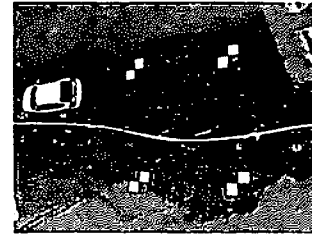

0.75 sec

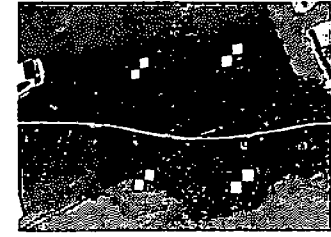

1 sec

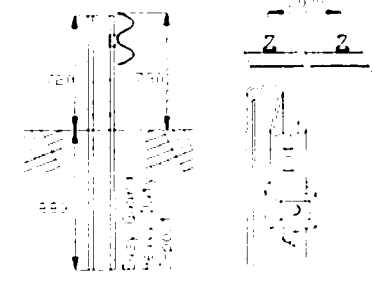
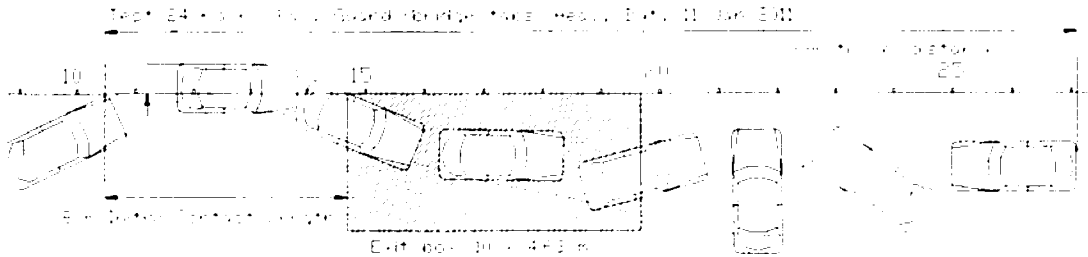

• Test Article	Longitudinal Guard Rail: Ezy-Guard Heavy Duty
• Total Length	90.0 m
• Key Elements – Barrier	
Description.....	W-Beam/steel post/carriage/dams
Length	60.0 meters LON
Rail Height.....	730 mm (29")
Post Spacing	2.0 m nominal
• Test Vehicle	
Designation.....	1100C
Make/Model.....	Kia Rio Liftback LS
Dimensions (lwh).....	4280 x 1640 x 2440 mm
Curb Wt.....	1106 kg
Test Inertial Wt.....	1110 kg
Gross Static Wt.....	1185 kg
• Impact Conditions	
Speed	100.8 kph
Angle	25°
Impact Point	1.0 m upstream of line post 11
• Exit Conditions	
Exit Speed	66.3 kph
Exit Angle	10°
• Vehicle Damage - Exterior	
VDS	11-LFQ -3
CDC	11LFEE2
Max. Deformation	260 mm

• Post Impact Vehicle Behaviour	
Vehicle Stability.....	Good
Stopping Distance.....	30 m
Initial Contact Length	8 m
Roll Angle Max.	12.8°
Pitch Angle Max.	15.1°
Yaw Angle Max.	-34.5°
• Vehicle Snagging	None
• Vehicle Pocketing	None
• Occupant Impact Velocity	
Longitudinal	7.4 m/s
Lateral (optional).....	4.5 m/s
ASI (Acceleration Severity Index)	0.73
• Occupant Ridedown Deceleration	
x-direction.....	-6.6 g (0.2040 - 0.2140 s)
y-direction.....	-7.6 g (0.1701 - 0.1801 s)
THIV (optional).....	30.0 kph @ 0.1391 s @ interior RHS (8.3m/s)
PHD (optional).....	8.7 g (0.1696 - 0.1796 s)
• Test Article Deflections	
Dynamic.....	0.96 m
Permanent.....	0.75 m
Working Width.....	1.16 m
• Test Article Damage	Moderate

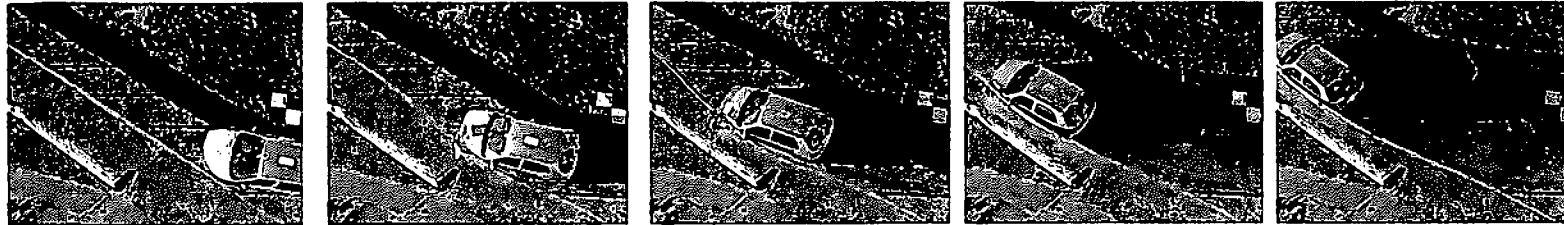

0.00 sec

0.083 sec

0.167 sec

0.25 sec

0.33 sec

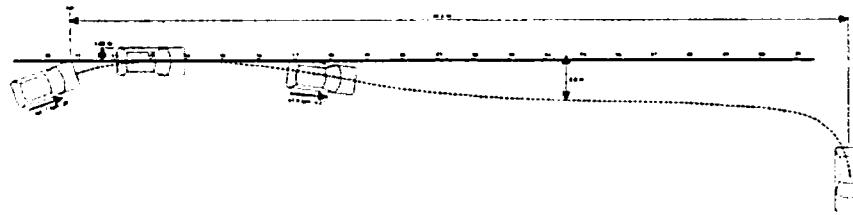

***TEST ARTICLE**

Ingal W-beam longitudinal barrier with U-section post

Test Level NCHRP Report 350
Test 3-10

Overall length..... 90.5 metres (297)
Length of need..... 60 metres (197)
Rail Height..... 790 mm (31") to top
Post Centres..... 2.0 m (78")
Soil Type..... AASHTO M147-65
Standard soil

***TEST VEHICLE**

Designation..... 820C - Small Car
Make/Model..... Toyota Starlet EP91
Dimensions (lwh).... 3730 x 1560 x 1425
Gross Weight..... 906 kg

***CIP**

0.95 metres upstream of line post 11

***IMPACT CONDITIONS**

Impact Speed 101.7 kph
Impact Angle 20 degrees
Exit Speed 61.5 kph
Exit Angle 6.2 degrees

***TEST ARTICLE DEFLECTIONS (METRES)**

Test Article Damage... Severe
Dynamic..... 1.02 metres
Permanent..... 0.49 metres
Working Width..... 1.02 metres

***VEHICLE DAMAGE - EXTERIOR**

VDS..... 11-LFQ-3
CDC..... 11-FYEE-2
Max Deformation 200 mm to front

***VEHICLE DAMAGE - INTERIOR**

OCDI..... AS00000000
Max. Deformation 20.0 mm

***POST IMPACT BEHAVIOUR**

Vehicle Stability..... Satisfactory
Stopping Distance... 65.5 metres from CIP
Max. Roll angle..... 19.8 degrees at 0.8132 sec
Max. Pitch angle..... 18.2 degrees at 0.4557 sec
Max. Yaw angle..... 87.7 degrees at 5.2777 sec

***OCCUPANT RISK VALUES**

IMPACT VELOCITY (M/S - RIGHT OF INTERIOR)

x-direction..... -5.4 m/s at 0.1523 sec
y-direction..... 4.4 m/s at 0.1523 sec
THIV 7.9 m/s at 0.1615 sec

RIDEDOWN DECELERATIONS (g)

x-direction..... 9.9 at 4.4988 - 4.5088 sec
y-direction..... -7.3 at 0.3784 - 0.3884 sec
PHD 10.0 at 4.5149 - 4.5249 sec
ASI 0.63 at 0.1016 - 0.1516 sec

MAX. 0.050 SECOND AVERAGE (g)

x-direction..... 6.7 at 4.4870 - 4.5370 sec
y-direction..... -4.5 at 0.1420 - 0.1920 sec
z-direction..... 2.8 at 0.1648 - 0.2148 sec



Test Summary

Test No. 102350.97.05.1.5.1

Holmes Solutions Limited, New Zealand

23 December 2010

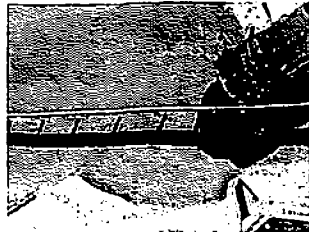
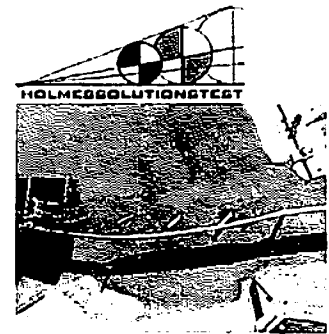

0.0 sec

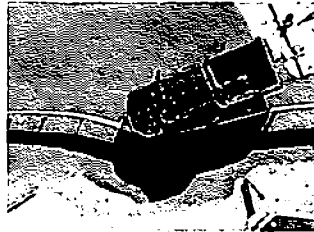

0.15 sec

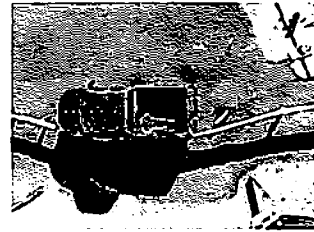

0.30 sec (W-rail break)

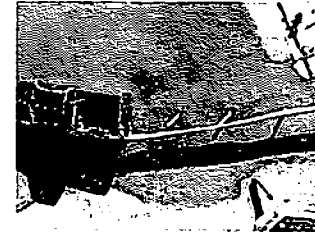

0.45 sec

0.60 sec

Figure 23 Initial Ezy-Guard Heavy Duty Image taken at 0.0 sec

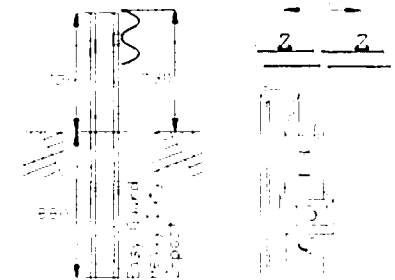
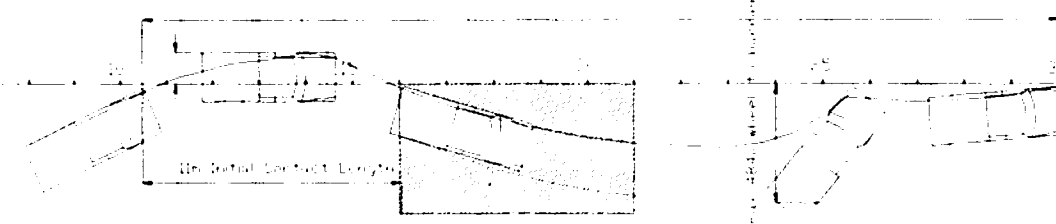

<ul style="list-style-type: none"> • Test Article • Total Length • Key Elements – Barrier <ul style="list-style-type: none"> Description..... Length Rail Height..... Post Spacing • Test Vehicle <ul style="list-style-type: none"> Designation..... Make/Model..... Dimensions (lwh)..... Curb weight..... Test Inertial Wt..... Gross Static Wt..... • Impact Conditions <ul style="list-style-type: none"> Speed Angle Impact Point • Exit Conditions <ul style="list-style-type: none"> Exit Speed Exit Angle • Vehicle Damage - Exterior <ul style="list-style-type: none"> VDS CDC Max. Deformation 	<p>Longitudinal Guard Rail: Ezy-Guard Heavy Duty 90.0 m</p> <p>W-Beam/steel post/carriage/Dams 60.0 m LON 730 mm (29") 2.0 m nominal</p> <p>2270P Dodge Ram 1500 5660 x 2000 x 1900 mm 2245 kg 2273 kg 2273 kg</p> <p>99.0 kph 25° 1.0 m upstream of Post 11</p> <p>68.4 kph 6°</p> <p>11- LFQ -3 11FLEE2 100mm</p>	<ul style="list-style-type: none"> • Post Impact Vehicle Behaviour Vehicle Stability..... Stopping Distance..... Initial Contact Length Roll Angle Max. Pitch Angle Max. Yaw Angle Max. • Vehicle Snagging • Vehicle Pocketing • Occupant Impact Velocity <ul style="list-style-type: none"> Longitudinal Lateral (optional)..... ASI (acceleration Severity Index: • Occupant Ride down Deceleration <ul style="list-style-type: none"> x-direction..... y-direction..... THIV (optional)..... PHD (optional)..... • Test Article Deflections <ul style="list-style-type: none"> Dynamic..... Permanent..... Working Width..... • Test Article Damage 	<p>Good</p> <p>39.5 m</p> <p>11 m</p> <p>-13.3°</p> <p>-12.3°</p> <p>-34.4°</p> <p>None</p> <p>None</p> <p>4.4 m/s</p> <p>4.6 m/s</p> <p>0.58</p> <p>-7.7 g (0.5582-0.5682 s)</p> <p>-5.7 g (0.2996-0.3096 s)</p> <p>21.9 kph (6.1 m/s) at 0.1504 s</p> <p>7.7 g (0.5582-0.5682 s)</p> <p>1.28 m</p> <p>1.00 m</p> <p>1.38 m</p> <p>Moderate</p>
--	---	--	--

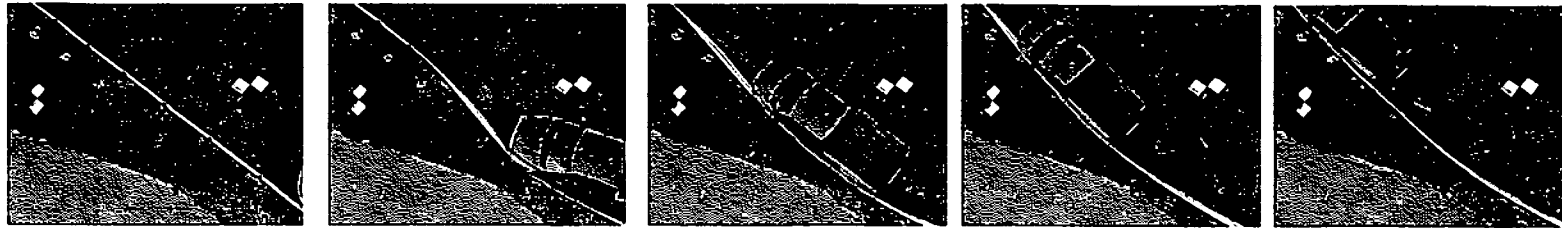

0.00 sec

0.17 sec

0.33 sec

0.50 sec

0.67 sec

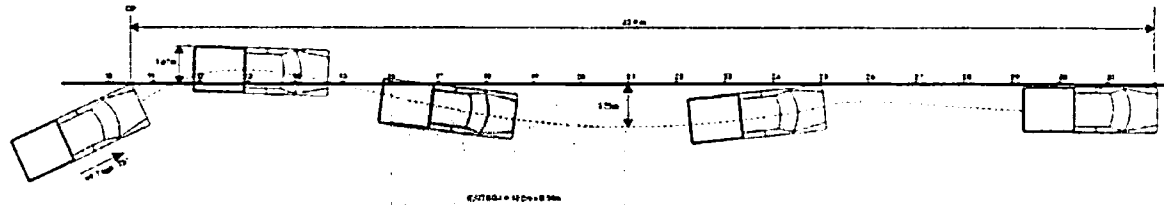

***TEST ARTICLE**

Ingal W-Beam longitudinal barrier with U-section post

Test Level NCHRP 350 Update
Test 3-11

Overall Length..... 90.5 m (297)
Length of Need..... 60.0 m (197)
Rail Height..... 790 mm (31") to top
Post Centres..... 2.0 m (78")

Soil Type..... AASHTO M147-65
Standard soil

***TEST VEHICLE**

Designation..... 2270P Pick-up Truck
Make/Model..... Dodge Ram 1500
Dimensions (lwh).... 5770 x 2015 x 1915 mm
Test Inertial Weight 2258 kg

***CIP**

1.48 m (58") upstream of line post 11

***IMPACT CONDITIONS**

Impact Speed 99.7 kph
Impact Angle 25 degrees
Exit Speed 60.0 kph
Exit Angle 6.5 degrees

***TEST ARTICLE DEFLECTIONS (METRES)**

Test Article Damage... Severe
Dynamic..... 1.67 m
Permanent..... 1.18 m
Working Width..... 1.67 m

***VEHICLE DAMAGE - EXTERIOR**

VDS..... 11-LFQ-3
CDC..... 11-FLEE-2
Max Deformation 150 mm (LF bumper)

***VEHICLE DAMAGE - INTERIOR**

OCDI..... AS 00000000
Max. Deformation 30 mm

***POST IMPACT BEHAVIOUR**

Vehicle Stability..... Satisfactory
Stopping Distance... 43.9 metres from CIP
Max. Roll angle..... 18.0 degrees at 3.468 sec
Max. Pitch angle..... 16.0 degrees at 3.076 sec
Max. Yaw angle..... 33.4 degrees at 0.488 sec

***OCCUPANT RISK VALUES**

IMPACT VELOCITY (M/S - RIGHT OF INTERIOR)

x-direction..... -1.3 m/s at 0.1331 sec
y-direction..... 4.9 m/s at 0.1331 sec
THIV 5.2 m/s at 0.1337 sec

RIDEDOWN DECELERATIONS (G)

x-direction..... 4.4 at 0.6265 - 0.6765 sec
y-direction..... -6.4 at 0.3062 - 0.3162 sec
PHD 6.8 at 0.2985 - 0.3085 sec
ASI 0.58 at 0.2110 - 0.2610 sec

MAX. 0.050 SECOND AVERAGE (G)

x-direction..... 2.5 at 0.0709 - 0.1209 sec
y-direction..... -5.1 at 0.2110 - 0.2610 sec
z-direction..... -2.4 at 0.3105 - 0.3605 sec

