



U.S. Department  
of Transportation  
**Federal Highway  
Administration**

May 26, 2020

1200 New Jersey Ave., SE  
Washington, D.C. 20590

In Reply Refer To:  
HSST-1/WZ-405

Mr. Felipe Almanza  
TrafFix Devices Inc.  
160 Avenida La Pata  
San Clemente California 92673

Dear Mr. Almanza:

This letter is in response to your January 28, 2020 request for the Federal Highway Administration (FHWA) to review a roadside safety device, hardware, or system for eligibility for reimbursement under the Federal-aid highway program. This FHWA letter of eligibility is assigned FHWA control number WZ-405 and is valid until a subsequent letter is issued by FHWA that expressly references this device.

### **Decision**

The following device is eligible within the length-of-need, with details provided in the form which is attached as an integral part of this letter:

- TrafFix Metal Leg Barricade

### **Scope of this Letter**

To be found eligible for Federal-aid funding, new roadside safety devices should meet the crash test and evaluation criteria contained in the American Association of State Highway and Transportation Officials' (AASHTO) Manual for Assessing Safety Hardware (MASH). However, the FHWA, the Department of Transportation, and the United States Government do not regulate the manufacture of roadside safety devices. Eligibility for reimbursement under the Federal-aid highway program does not establish approval, certification or endorsement of the device for any particular purpose or use.

This letter is not a determination by the FHWA, the Department of Transportation, or the United States Government that a vehicle crash involving the device will result in any particular outcome, nor is it a guarantee of the in-service performance of this device. Proper manufacturing, installation, and maintenance are required in order for this device to function as tested.

This finding of eligibility is limited to the crashworthiness of the system and does not cover other structural features, nor conformity with the Manual on Uniform Traffic Control Devices.

### **Eligibility for Reimbursement**

Based solely on a review of crash test results and certifications submitted by the manufacturer, and the crash test laboratory, FHWA agrees that the device described herein meets the crash test and evaluation criteria of the AASHTO's MASH. Therefore, the device is eligible for reimbursement under the Federal-aid highway program if installed under the range of tested conditions.

Name of system: TrafFix Metal Leg Barrier  
Type of system: Work Zone  
Test Level: MASH Test Level 3 (TL3)  
Testing conducted by: KARCO  
Date of request: January 28, 2020

FHWA concurs with the recommendation of the accredited crash testing laboratory on the attached form.

### **Full Description of the Eligible Device**

The device and supporting documentation, including reports of the crash tests or other testing done, videos of any crash testing, and/or drawings of the device, are described in the attached form.

### **Notice**

This eligibility letter is issued for the subject device as tested. Modifications made to the device are not covered by this letter. Any modifications to this device should be submitted to the user (i.e., state DOT) as per their requirements.

You are expected to supply potential users with sufficient information on design, installation and maintenance requirements to ensure proper performance.

You are expected to certify to potential users that the hardware furnished has the same chemistry, mechanical properties, and geometry as that submitted for review, and that it will meet the test and evaluation criteria of AASHTO's MASH.

Issuance of this letter does not convey property rights of any sort or any exclusive privilege. This letter is based on the premise that information and reports submitted by you are accurate and correct. We reserve the right to modify or revoke this letter if: (1) there are any inaccuracies in the information submitted in support of your request for this letter, (2) the qualification testing was flawed, (3) in-service performance or other information reveals safety problems, (4) the system is significantly different from the version that was crash tested, or (5) any other information indicates that the letter was issued in error or otherwise does not reflect full and complete information about the crashworthiness of the system.

### **Standard Provisions**

- To prevent misunderstanding by others, this letter of eligibility designated as FHWA control number WZ-405 shall not be reproduced except in full. This letter and the test documentation upon which it is based are public information. All such letters and documentation may be reviewed upon request.
- This letter shall not be construed as authorization or consent by the FHWA to use, manufacture, or sell any patented system for which the applicant is not the patent holder.
- This FHWA eligibility letter is not an expression of any Agency view, position, or determination of validity, scope, or ownership of any intellectual property rights to a specific device or design. Further, this letter does not impute any distribution or licensing rights to the requester. This FHWA eligibility letter determination is made based solely on the crash-testing information submitted by the requester. The FHWA reserves the right to review and revoke an earlier eligibility determination after receipt of subsequent information related to crash testing.

Sincerely,



Michael S. Griffith  
Director, Office of Safety Technologies  
Office of Safety

Enclosures

## Request for Federal Aid Reimbursement Eligibility of Highway Safety Hardware

|                  |  |   |   |
|------------------|--|---|---|
| <b>Submitter</b> | Date of Request:   | January 28, 2020                          | <input checked="" type="radio"/> New <input type="radio"/> Resubmission |
|                  | Name:  | Robby Ramirez                             |   |
|                  | Company:   | TrafFix Devices, Inc.                     |   |
|                  | Address:   | 160 Avenida LaPata San Clemente CA, 92673 |   |
|                  | Country:   | United States                             |   |
| To:              | Michael S. Griffith, Director<br>FHWA, Office of Safety Technologies |   |   |

I request the following devices be considered eligible for reimbursement under the Federal-aid highway program.

**Device & Testing Criterion** - Enter from right to left starting with Test Level

!-!-!

!-!-!

| System Type                 | Submission Type   | Device Name / Variant | Testing Criterion | Test Level |
|-----------------------------|---|-----------------------|-------------------|------------|
| 'WZ':Crash Worthy Work Zone | <input checked="" type="radio"/> Physical Crash Testing<br><input type="radio"/> Engineering Analysis | Metal Leg Barricade   | AASHTO MASH       | TL3        |

By submitting this request for review and evaluation by the Federal Highway Administration, I certify that the product(s) was (were) tested in conformity with the AASHTO Manual for Assessing Safety Hardware and that the evaluation results meet the appropriate evaluation criteria in the MASH.

**Individual or Organization responsible for the product:**

|               |  |   |
|---------------|--|---|
| Contact Name: | Robby Ramirez                            | Same as Submitter <input checked="" type="checkbox"/> |
| Company Name: | TrafFix Devices, Inc.                    | Same as Submitter <input checked="" type="checkbox"/> |
| Address:      | 160 Avenida LaPata San Clemente CA 92673 | Same as Submitter <input checked="" type="checkbox"/> |
| Country:      | United States                            | Same as Submitter <input checked="" type="checkbox"/> |

Enter below all disclosures of financial interests as required by the FHWA 'Federal-Aid Reimbursement Eligibility Process for Safety Hardware Devices' document.

TrafFix Devices Inc. and Applus IDIADA KARCO Engineering LLC share no financial interests between the two organizations. This includes no shared financial interest but not limited to:

- i. Compensation including wages, salaries, commissions, professional fees, or fees for business referrals
- ii. Consulting relationships
- iii. Research funding or other forms of research support;
- iv. Patents, copyrights, licenses, and other intellectual property interests;
- vi. Business ownership and investment interests.

## PRODUCT DESCRIPTION

Help

- New Hardware or Significant Modification
  Modification to Existing Hardware

The TrafFix Devices Metal Leg Barricade is a temporary work-zone traffic control device consisting of two (2) steel leg assemblies and four (4) impact resistant plastic panels.

The steel leg assemblies are composed of two (2) steel supports that are bolted together at the top. When the legs are in the deployed position the stand has a footprint of approximately 35 in. (889 mm) by 24 in. (610 mm). The panels are mounted to the leg assemblies by through bolting or riveting.

The plastic panels are 24.0 in (610 mm) wide and 0.5 in. (13 mm) thick. The panel's edges are raised to protect the reflective sheeting during transportation and stacking. The barricade uses 8.0 in. (203 mm) or 12.0 in. (305 mm) tall top panels with reflective sheeting. The bottom panels can be either 6.0 in. (152 mm) or 8.0 in. (203 mm) with or without reflective sheeting. The bottom 8.0 in. (203 mm) panel is available as a standard panel or a sand filled option that weighs approximately 15 lbs (6.8 kg) when filled. The barricade was tested with a sand bag and a sand filled panel. The barricade can be used with or without ballast.

The barricade in the deployed state holds the panels at a height to comply with the MUTCD. The barricade can be configured as a type 1 or a type 2 barricade. The as-tested device was configured as a Type 2 Barricade. A warning light was mounted to the device during crash testing. The barricade can be used with or without a warning light. The TrafFix Devices Metal Leg Barricade remained unchanged from the tested and passed NCHRP 350 version.

## CRASH TESTING

By signature below, the Engineer affiliated with the testing laboratory, agrees in support of this submission that all of the critical and relevant crash tests for this device listed above were conducted to meet the MASH test criteria. The Engineer has determined that no other crash tests are necessary to determine the device meets the MASH criteria.

|                     |                                     |   |
|---------------------|-------------------------------------|---|
| Engineer Name:      | Steven Matsusaka                    |   |
| Engineer Signature: | <b>Steven Matsusaka</b>             | Digitally signed by Steven Matsusaka<br>DN: cn=Steven Matsusaka, email=steven.matsusaka@idiada.com, c=US<br>Date: 2020.03.02 15:35:28 -08'00' |
| Address:            | 9270 Holly Road, Adelanto, CA 92301 | Same as Submitter <input type="checkbox"/>  |
| Country:            | United States                       | Same as Submitter <input type="checkbox"/>  |

A brief description of each crash test and its result: Help

| Required Test Number | Narrative Description  | Evaluation Results               |
|----------------------|--|----------------------------------|
| 3-70 (1100C)         | Designed to evaluate the ability of a small vehicle to activate any breakaway, fracture, or yielding mechanism. Per MASH Test 3-70 is considered optional for work-zone traffic control devices weighing less than 220 lbs (100 kg). The as-tested devices weighed approximately 33 lbs (15 kg) and therefore test 3-70 was not conducted. | Non-Relevant Test, not conducted |

| Required Test Number | Narrative Description   | Evaluation Results |
|----------------------|---|--------------------|
| 3-71 (1100C)         | <p>Test report number P39096-01, conducted on 04/05/19. Test 3-71 involves an 1100C test vehicle impacting the temporary work-zone traffic control device at a critical impact angle of 90° and 0°. The test is designed to evaluate occupant compartment penetration, vehicle stability, and occupant risk criteria. The test vehicle was a commercially available 2009 Kia Rio with a test inertial weight of 2,399.7 lbs (1088.5 kg).</p> <p>The test vehicle impacted the first barricade oriented at 90° at a speed of 62.03 mph (99.83 km/h). There was no penetration into the occupant compartment and no vehicle instability was induced. The vehicle cleared the device in a controlled manner and continued to impact the second barricade oriented at 0° at a speed of 59.79 mph (96.22 km/h). The barricade was activated in a predictable manner and did not penetrate the occupant compartment. The Traffix Metal Leg Barricade did not induce vehicle instability, block the driver's vision, and did not create a debris field that would present undue hazards to other traffic, pedestrians, or personnel in a work zone. The occupant compartment was not penetrated and the deformation limits were not exceeded. The Traffix Devices Metal Leg Barricade met all the requirements for MASH Test 3-71.</p> | PASS               |

|              |   |      |
|--------------|---|------|
| 3-72 (2270P) | <p>Test report number P39096-02, conducted on 04/05/19. Test 3-72 involves a 2270P test vehicle impacting the temporary work-zone traffic control device at a critical impact angle of 90° and 0°. The test is designed to evaluate occupant compartment penetration, vehicle stability, and occupant risk criteria. The test vehicle was a commercially available 2013 RAM 1500 with a test inertial weight of 5,025.4 lbs (2,279.5 kg).</p> <p>The test vehicle impacted the first barricade oriented at 90° at a speed of 60.42 mph (97.23 km/h). There was no penetration into the occupant compartment and no vehicle instability was induced. The vehicle cleared the device in a controlled manner and continued to impact the second barricade oriented at 0° at a speed of 59.53 mph (95.81 km/h). The barricade was activated in a predictable manner and did not penetrate the occupant compartment. The Traffix Metal Leg Barricade did not induce vehicle instability, block the drivers vision, and did not create a debris field that would present undue hazards to other traffic, pedestrians, or personnel in a work zone. The occupant compartment was not penetrated and the deformation limits were not exceeded. The Traffix Devices Metal Leg Barricade met all the requirements for MASH Test 3-72.</p> | PASS |
|--------------|---|------|

Full Scale Crash Testing was done in compliance with MASH by the following accredited crash test laboratory (cite the laboratory's accreditation status as noted in the crash test reports.):

|  |   |  |
|--|---|--|
| Laboratory Name:   | Applus IDIADA KARCO Engineering, LLC.   |  |
| Laboratory Signature:  |  | <small>DN: cn=Steven Matsusaka, email=steven.matsusaka@idiada.com, c=US<br/>Digitally signed by Steven Matsusaka<br/>Date: 2020.03.02 15:35:41 -08'00'</small> |
| Address:   | 9270 Holly Road, Adelanto, CA 92301   | Same as Submitter <input type="checkbox"/>   |
| Country:   | United States   | Same as Submitter <input type="checkbox"/>   |
| Accreditation Certificate Number and Dates of current Accreditation period : | TL-371: July 2019 - July 2022   |  |

Submitter Signature\*:  Robert Ramirez  
Digitally signed by Robert Ramirez  
Date: 2020.03.03 10:41:18 -08'00'

Submit Form

## ATTACHMENTS

Attach to this form:

- 1) Additional disclosures of related financial interest as indicated above.
- 2) A copy of the full test report, video, and a Test Data Summary Sheet for each test conducted in support of this request.
- 3) A drawing or drawings of the device(s) that conform to the Task Force-13 Drawing Specifications [[Hardware Guide Drawing Standards](#)]. For proprietary products, a single isometric line drawing is usually acceptable to illustrate the product, with detailed specifications, intended use, and contact information provided on the reverse. Additional drawings (not in TF-13 format) showing details that are relevant to understanding the dimensions and performance of the device should also be submitted to facilitate our review.

FHWA Official Business Only:

| Eligibility Letter |      |           |
|--------------------|------|-----------|
| Number             | Date | Key Words |
|                    |      |           |



# MASH 2016 Test 3-71 Summary

90° CIA

0° CIA

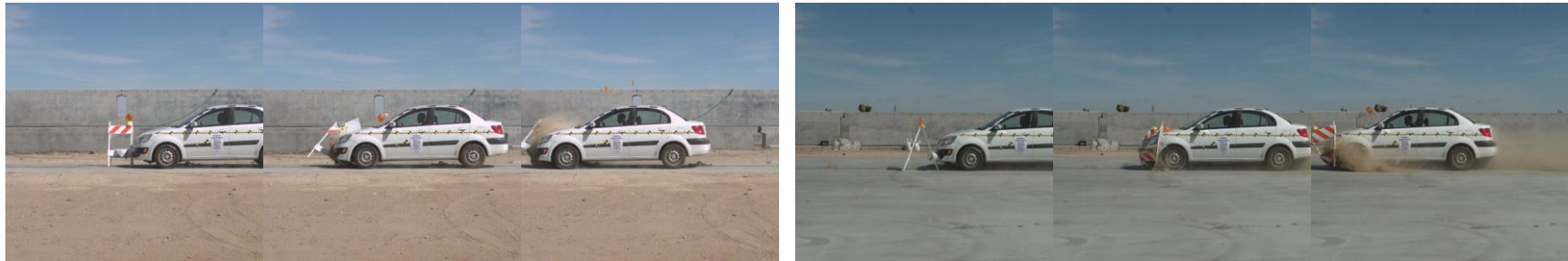

0.000 s

0.050 s

0.100 s

0.671 s

0.721 s

0.791 s

308.7 ft. [94.1 m]

4.4 ft. [1.3 m]



## GENERAL INFORMATION

Test Agency..... Applus IDIADA KARCO  
 Test No..... P39096-01  
 Test Designation..... 3-71  
 Test Date..... 4/5/19

## TEST ARTICLE

Name / Model..... Metal Leg Barricade  
 Type..... Work-Zone Device  
 Device Height ..... 3.5 ft. (1.1 m)  
 Key Elements..... Leg assembly, top and bottom panel  
 Road Surface..... Concrete

## TEST VEHICLE

Type / Designation..... 1100C  
 Year, Make, and Model..... 2009 Kia Rio  
 Curb Mass..... 2,335.7 lbs (1,059.5 kg)  
 Test Inertial Mass..... 2,399.7 lbs (1,088.5 kg)  
 Gross Static Mass..... 2,565.1 lbs (1,163.5 kg)

## Impact Conditions

Impact Velocity Device 1..... 62.03 mph (99.83 km/h)  
 Impact Velocity Device 2..... 59.79 mph (96.22 km/h)  
 Device 1 Angle..... 90.0°  
 Device 2 Angle..... 0.0°  
 Device 1 Kinetic Energy..... 308.7 kip-ft (418.5 kJ)  
 Device 2 Kinetic Energy..... 286.8 kip-ft (388.8 kJ)

## Exit Conditions

Device 1 Exit Velocity..... 60.9 mph (98.1 km/h)  
 Device 2 Exit Velocity..... 58.5 mph (94.2 km/h)  
 Vehicle Resting Position..... 308.7 ft. (94.1 m) Downstream  
 4.4 ft. (1.3 m) Left  
 Vehicle Stability ..... Satisfactory  
 Maximum Roll Angle..... N/A\*  
 Maximum Pitch Angle..... N/A\*  
 Maximum Yaw Angle..... N/A\*

\* Not Applicable, device weighs less than 220 lbs (100 kg)

## Occupant Risk

Longitudinal OIV..... N/A\*  
 Lateral OIV..... N/A\*  
 Longitudinal RA..... N/A\*  
 Lateral RA..... N/A\*  
 THIV..... N/A\*  
 PHD..... N/A\*  
 ASI..... N/A\*

## Test Article Deflections

Debris Field (longitudinal) ..... 209.3 ft. (63.8 m)  
 Debris Field (lateral)..... 31.0 ft. (9.4 m)

## Vehicle Damage

Vehicle Damage Scale..... 12-FC-1  
 CDC..... 12FCMW1  
 Maximum Intrusion..... 0.2 in. (5 mm) at floor pan

Figure 2 Summary of Test 3-71

# MASH 2016 Test 3-72 Summary

90° CIA

0° CIA

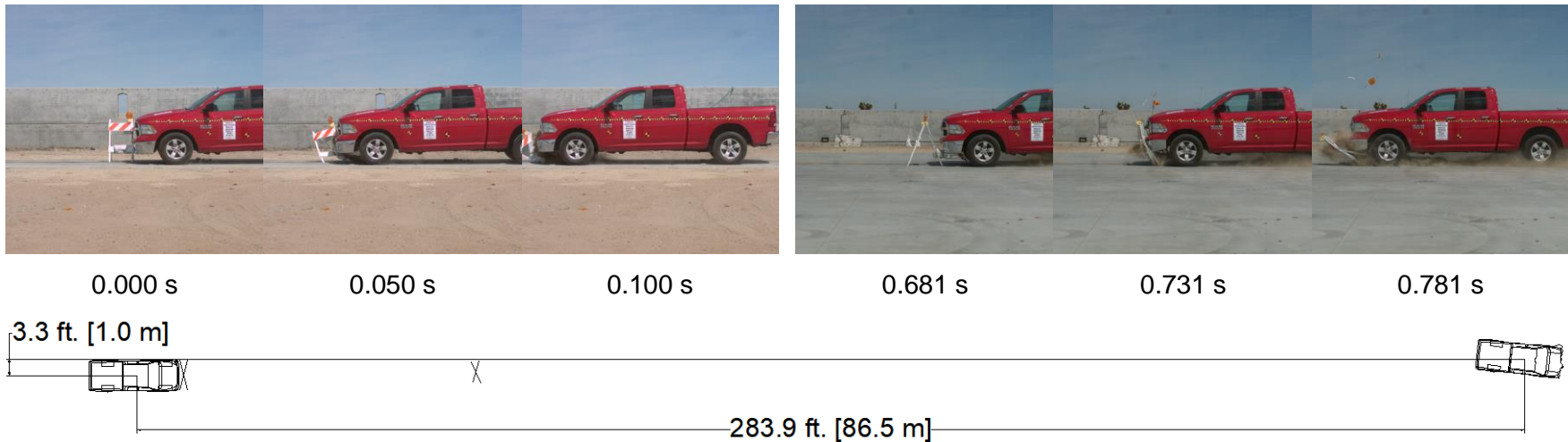

| <b>GENERAL INFORMATION</b> |                              |
|----------------------------|------------------------------|
| Test Agency.....           | Applus IDIADA KARCO          |
| Test No.....               | P39096-02                    |
| Test Designation.....      | 3-72                         |
| Test Date.....             | 4/5/19                       |
| <b>TEST ARTICLE</b>        |                              |
| Name / Model.....          | Metal Leg Barricade          |
| Type.....                  | Work-Zone Device             |
| Device Height .....        | 3.5 ft. (1.1 m)              |
| Key Elements.....          | Leg assembly, top and bottom |
| Road Surface.....          | Concrete                     |
| <b>TEST VEHICLE</b>        |                              |
| Type / Designation.....    | 2270P                        |
| Year, Make, and Model..... | 2013, RAM 1500               |
| Curb Mass.....             | 4,857.8 lbs (2,203.5 kg)     |
| Test Inertial Mass.....    | 5,025.4 lbs (2,279.5 kg)     |
| Gross Static Mass.....     | 5,025.3 lbs (2,279.5 kg)     |

| <b>Impact Conditions</b>      |   |
|-------------------------------|---|
| Impact Velocity Device 1..... | 60.42 mph (97.23 km/h)                              |
| Impact Velocity Device 2..... | 59.53 mph (95.81 km/h)                              |
| Device 1 Angle.....           | 90.0°   |
| Device 2 Angle.....           | 0.0°  |
| Device 1 Kinetic Energy.....  | 613.2 kip-ft (831.4 kJ)                             |
| Device 2 Kinetic Energy.....  | 595.4 kip-ft (807.3 kJ)                             |
| <b>Exit Conditions</b>        |   |
| Device 1 Exit Velocity.....   | 59.7 mph (96.1 km/h)                                |
| Device 2 Exit Velocity.....   | 58.2 mph (93.7 km/h)                                |
| Vehicle Resting Position..... | 283.9 ft. (86.5 m) Downstream<br>3.3 ft. (1 m) Left |
| Vehicle Stability .....       | Satisfactory  |
| Maximum Roll Angle.....       | N/A*  |
| Maximum Pitch Angle.....      | N/A*  |
| Maximum Yaw Angle.....        | N/A*  |

\* Not applicable, device weighs less than 220 lbs (100 kg)

| <b>Occupant Risk</b>              |                             |
|-----------------------------------|-----------------------------|
| Longitudinal OIV.....             | N/A*                        |
| Lateral OIV.....                  | N/A*                        |
| Longitudinal RA.....              | N/A*                        |
| Lateral RA.....                   | N/A*                        |
| THIV.....                         | N/A*                        |
| PHD.....                          | N/A*                        |
| ASI.....                          | N/A*                        |
| <b>Test Article Deflections</b>   |                             |
| Debris Field (longitudinal) ..... | 216.9 ft. (66.1 m)          |
| Debris Field (lateral).....       | 39.0 ft. (11.9 m)           |
| <b>Vehicle Damage</b>             |                             |
| Vehicle Damage Scale.....         | 12-FD-1                     |
| CDC.....                          | 12FDAW1                     |
| Maximum Intrusion.....            | 0.2 in. (5 mm) at floor pan |

Figure 2 Summary of Test 3-72

8 7 6 5 4 3 2 1

| ITEM NO. | DESCRIPTION      |
|----------|------------------|
| 1        | TOP PANEL        |
| 1A       | 12" X 24" PANEL  |
| 1B       | 8" X 24" PANEL   |
| 2        | BOTTOM PANEL     |
| 2A       | 6" X 24" PANEL   |
| 2B       | 8" X 24" PANEL   |
| 2C       | 8" X 24" SAN-FIL |

D

C

B

A

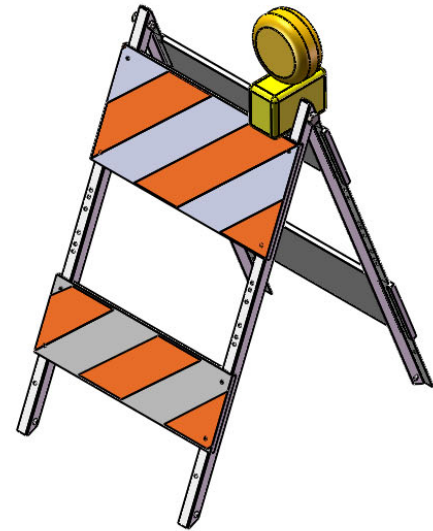
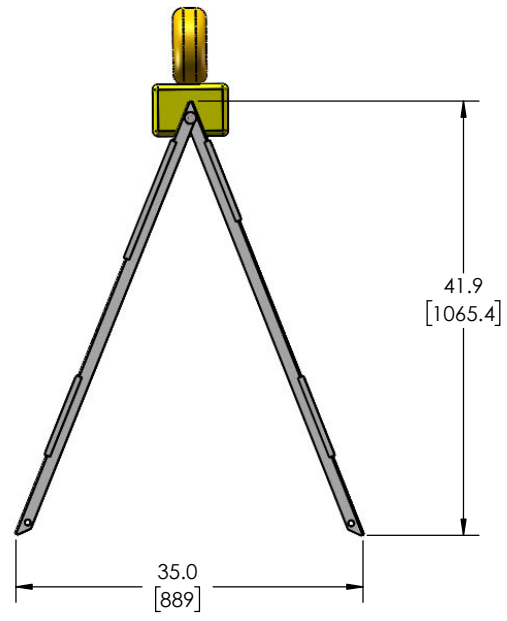
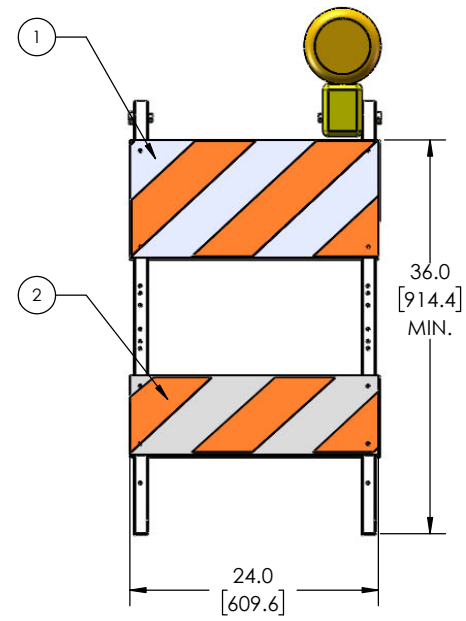

D

C

B

A

3. Units: Inches [mm]  
 2. Leg Material: Available in 12 Ga. or 14 Ga.  
 1. Finish: White or Galvanized  
**NOTES: Unless Otherwise Specified**

|   |                   |   |                        |
|---|-------------------|---|------------------------|
| <small>UNLESS OTHERWISE SPECIFIED:<br/>                 ALL DIMENSIONS ARE IN INCHES[mm].<br/>                 TOLERANCES:<br/>                 FRACTIONAL: X/X ±1/16" [1.6mm]<br/>                 DECIMAL: XX ±0.025"<br/>                 XXX ±0.02"<br/>                 XXXX ±0.015"<br/>                 DEGREES: ±0.5°</small> |                   | <b>Traffix Devices Inc.</b>  160 Avenida La Pata<br>San Clemente, CA 92673<br>(949) 361-5663<br>FAX (949) 361-9205<br>www.traffixdevices.com |                        |
| TITLE:<br><b>Traffix Metal Leg Barricade</b>  |                   |   |                        |
| DRAWN BY:<br>RLP  | DATE:<br>04/15/13 | SIZE<br><b>B</b>  | DRAWING NO.<br>500-214 |
| CHECKED BY:<br>GM   | DATE:<br>11/16/13 | REV<br><b>A</b>   | SHEET 1 OF 1           |
| APPROVED BY:<br>GM  | DATE:<br>11/16/13 |   |                        |

8 7 6 5 4 3 2 1