

ROUNDBABOUTS: AN INFORMATIONAL GUIDE



U.S. Department of Transportation
Federal Highway Administration

Publication No.
FHWA-RD-00-067

1. Report No. FHWA-RD-00-067		2. Government Accession No.		3. Recipient's Catalog No.	
4. Title and Subtitle ROUNDABOUTS: An Informational Guide				5. Report Date June 2000	
				6. Performing Organization Code	
7. Author(s) Principal Investigator: Bruce W. Robinson (brobinson@kittelton.com) Co-Investigators: Lee Rodegerdts, Wade Scarborough, Wayne Kittelson. Co-Authors: Rod Troutbeck, Werner Brilon, Lothar Bondzio, Ken Courage, Michael Kyte, John Mason, Aimee Flannery, Edward Myers, Jonathan Bunker, Georges Jacquemart.				8. Performing Organization Report No. Project 2425	
9. Performing Organization Name and Address Kittelton & Associates, Inc. http://roundabouts.kittelton.com 610 SW Alder Street, Suite 700 Portland, Oregon 97205 U.S.A. Subconsultants: Queensland University of Technology (Australia); Ruhr-University Bochum (Germany); University of Florida; University of Idaho; Pennsylvania State University; Hurst-Rosche Engineers; Eppell Olsen & Partners (Australia); Buckhurst Fish and Jacquemart.				10. Work Unit No. (TRAIS)	
				11. Contract or Grant No. DTFH61-97-R-00038	
12. Sponsoring Agency Name and Address Federal Highway Administration Turner-Fairbank Highway Research Center 6300 Georgetown Pike, HSR 20, Room No. T301 McLean, Virginia 22101				13. Type of Report and Period Covered Informational Guide Book September 1997 to December 1999	
				14. Sponsoring Agency Code	
15. Supplementary Notes Joe G. Bared (Joe.Bared@fhwa.dot.gov) at the Turner-Fairbank Highway Research Center (http://www.tfrc.gov) was the Technical Representative for the Federal Highway Administration.					
16. Abstract The guidance supplied in this document, <i>Roundabouts: An Informational Guide</i> , is based on established international and U.S. practices and is supplemented by recent research. The guide is comprehensive in recognition of the diverse needs of transportation professionals and the public for introductory material through design detail, as well as the wide range of potential applications of roundabout intersections. The following topics are addressed: definition of a roundabout and what distinguishes roundabouts from traffic circles; public acceptance and legal issues associated with roundabouts; consideration of all user modes, including heavy vehicles, buses, transit, bicycles, and pedestrians; a methodology for identifying appropriate sites for roundabouts and the range of conditions for which roundabouts offer optimal performance; methodologies for estimating roundabout capacity, delays, and queues with reference to the <i>Highway Capacity Manual</i> ; design principles and guidance on safety and geometric design, with reference to applicable national standards such as the <i>AASHTO Policy on Geometric Design of Highways and Streets</i> ; guidelines for control features such as signing and pavement markings, with reference to the <i>Manual on Uniform Traffic Control Devices</i> ; illumination; and landscaping.					
17. Key Word Roundabout(s), Traffic Circle(s), Intersection, Traffic Control, Intersection Design, Intersection Performance, Intersection Safety, Highway Capacity				18. Distribution Statement No restrictions. This document is available to the public through the National Technical Information Service, Springfield, Virginia 22181.	
19. Security Classif. (of this report) Unclassified		20. Security Classif. (of this page) Unclassified		21. No. of Pages 284	22. Price

Roundabouts

An Informational Guide

Kittelson & Associates, Inc.

Queensland University of Technology

Ruhr-University Bochum

University of Florida

University of Idaho

Pennsylvania State University

Hurst-Rosche Engineers

Eppell Olsen & Partners

Buckhurst Fish & Jacquemart

FHWA Project Manager:

Joe Bared

Joe.Bared@fhwa.dot.gov

202-493-3314

<http://www.tfrc.gov>



U.S. Department
of Transportation

**Federal Highway
Administration**

Publication No.

FHWA-RD-00-067

Foreword

Roundabouts are a form of intersection control in common use throughout the world. Until recently, many transportation professionals and agencies in the United States have been hesitant to recommend and install roundabouts, however, due to a lack of objective nationwide guidelines on planning, performance, and design of roundabouts. Prior to the development of this guide, transportation professionals who were interested in roundabouts had to rely on foreign roundabout design guides, consultants with roundabout experience, or in some States, statewide roundabout design guides. To facilitate safe, optimal operation and designs that are both consistent at a national level and consequential for driver expectation and safety, the Federal Highway Administration (FHWA) developed this informational guide on roundabouts.

The information supplied in this document, *Roundabouts: An Informational Guide*, is based on established international and U.S. practices and is supplemented by recent research. The guide is comprehensive in recognition of the diverse needs of transportation professionals and the public for introductory material through design detail, as well as the wide range of potential applications of roundabout intersections.

Roundabout operation and safety performance are particularly sensitive to geometric design elements. Uncertainty regarding evaluation procedures can result in over-design and less safety. The “design problem” is essentially one of determining a design that will accommodate the traffic demand while minimizing some combination of delay, crashes, and cost to all users, including motor vehicles, pedestrians, and bicyclists. Evaluation procedures are suggested, or information is provided, to quantify and cost how well a design achieves each of these aims.

Since there is no absolutely optimum design, this guide is not intended as an inflexible “rule book,” but rather attempts to explain some principles of good design and indicate potential tradeoffs. In this respect, the “design space” consists of performance evaluation models and design principles such as those provided in this guide, combined with the expert heuristic knowledge of a designer. Adherence to these principles still does not ensure good design, which remains the responsibility of the designer.



Michael F. Trentacoste
Director, Office of Safety Research and Development

NOTICE

This publication is disseminated under the sponsorship of the Department of Transportation in the interest of information exchange. The publication does not constitute a standard, specification, or regulation. Any trade or manufacturers' names that appear herein are included solely because they are considered essential to the object of the publication.

Table of Contents

List of Exhibits	viii
Photo Credits	xiv
Chapter 1 - Introduction	1
1.1 Scope of Guide	2
1.2 Organization of Guide	3
1.3 Defining Physical Features	5
1.4 Key Dimensions	5
1.5 Distinguishing Roundabouts from Other Circular Intersections	8
1.6 Roundabout Categories	12
1.7 References	20
Chapter 2 - Policy Considerations	21
2.1 Characteristics	23
2.2 Multimodal Considerations	32
2.3 Costs Associated with Roundabouts	36
2.4 Legal Considerations	37
2.5 Public Involvement	40
2.6 Education	43
2.7 References	48
Chapter 3 - Planning	49
3.1 Planning Steps	51
3.2 Considerations of Context	53
3.3 Number of Entry Lanes	55
3.4 Selection Categories	58
3.5 Comparing Operational Performance of Alternative Intersection Types	64
3.6 Space Requirements	69

3.7	Economic Evaluation	70
3.8	References	76
Chapter 4 - Operation		79
4.1	Traffic Operation at Roundabouts	82
4.2	Data Requirements	83
4.3	Capacity	86
4.4	Performance Analysis	91
4.5	Computer Software for Roundabouts	96
4.6	References	98
Chapter 5 - Safety		101
5.1	Introduction	103
5.2	Conflicts	104
5.3	Crash Statistics	111
5.4	Crash Prediction Models	122
5.5	References	125
Chapter 6 - Geometric Design		127
6.1	Introduction	130
6.2	General Design Principles	132
6.3	Geometric Elements	145
6.4	Double-Lane Roundabouts	172
6.5	Rural Roundabouts	176
6.6	Mini-Roundabouts	179
6.7	References	181

Chapter 7 - Traffic Design and Landscaping	183
7.1 Signing	185
7.2 Pavement Markings	197
7.3 Illumination	202
7.4 Work Zone Traffic Control	205
7.5 Landscaping	207
7.6 References	209
Chapter 8 - System Considerations	211
8.1 Traffic Signals at Roundabouts	213
8.2 At-Grade Rail Crossings	215
8.3 Closely Spaced Roundabouts	217
8.4 Roundabout Interchanges	219
8.5 Roundabouts in an Arterial Network	223
8.6 Microscopic Simulation	227
8.7 References	229
Glossary	231
Bibliography	240
Appendix A: Operations Analysis Formulas	251
Appendix B: Example Roundabout Designs	257
Appendix C: MUTCD Recommendations	265

List of Exhibits

Chapter 1 - Introduction

Exhibit 1-1.	Drawing of key roundabout features.	6
Exhibit 1-2.	Description of key roundabout features.	6
Exhibit 1-3.	Drawing of key roundabout dimensions.	7
Exhibit 1-4.	Description of key roundabout dimensions.	7
Exhibit 1-5.	Comparison of roundabouts with traffic circles.	8
Exhibit 1-6.	Common design elements at roundabouts.	10
Exhibit 1-7.	Basic design characteristics for each of the six roundabout categories.	13
Exhibit 1-8.	Typical mini-roundabout.	14
Exhibit 1-9.	Typical urban compact.	15
Exhibit 1-10.	Typical urban single-lane roundabout.	16
Exhibit 1-11.	Typical urban double-lane roundabout.	17
Exhibit 1-12.	Typical rural single-lane roundabout.	18
Exhibit 1-13.	Typical rural double-lane roundabout	19

Chapter 2 - Policy Considerations

Exhibit 2-1.	Average annual crash frequencies at 11 U.S. intersections converted to roundabouts.	23
Exhibit 2-2.	Pedestrian's chances of death if hit by a motor vehicle.	25
Exhibit 2-3.	Comparisons of vehicle-vehicle conflict points for intersections with four single-lane approaches.	26
Exhibit 2-4.	Fastest vehicle path through a double-lane roundabout.	27
Exhibit 2-5.	Examples of aesthetic treatments.	31
Exhibit 2-6.	Examples of informational brochures.	42
Exhibit 2-7.	Driving straight through a roundabout.	45
Exhibit 2-8.	Turning left at a roundabout.	46

Chapter 3 - Planning

Exhibit 3-1.	Maximum daily service volumes for a four-leg roundabout.	57
Exhibit 3-2.	Planning-level maximum daily service volumes for mini-roundabouts.	57

Exhibit 3-3.	Example of community enhancement roundabout.	59
Exhibit 3-4.	Example of traffic calming roundabouts.	60
Exhibit 3-5.	Comparison of predicted rural roundabout injury crashes with rural TWSC intersections.	61
Exhibit 3-6.	Comparisons of predicted injury crashes for single-lane and double-lane roundabouts with rural or urban signalized intersections.	61
Exhibit 3-7.	Average delay per vehicle at the MUTCD peak hour signal warrant threshold.	63
Exhibit 3-8.	Comparison of TWSC and single-lane roundabout capacity.	65
Exhibit 3-9.	Sample hourly distribution of traffic.	66
Exhibit 3-10.	Annual savings in delay of single-lane roundabout versus AWSC, 50 percent of volume on the major street.	67
Exhibit 3-11.	Annual savings in delay of single-lane roundabout versus AWSC, 65 percent of volume on the major street.	67
Exhibit 3-12.	Delay savings for roundabouts vs. signal, 50 percent volume on major street.	69
Exhibit 3-13.	Delay savings for roundabouts vs. signal, 65 percent volume on major street.	69
Exhibit 3-14.	Assumptions for spatial comparison of roundabouts and comparable conventional intersections.	70
Exhibit 3-15.	Area comparison: Urban compact roundabout vs. comparable signalized intersection.	71
Exhibit 3-16.	Area comparison: Urban single-lane roundabout vs. comparable signalized intersection.	71
Exhibit 3-17.	Area comparison: Urban double-lane roundabout vs. comparable signalized intersection.	72
Exhibit 3-18.	Area comparison: Urban flared roundabouts vs. comparable signalized intersection.	72
Exhibit 3-19.	Estimated costs for crashes of varying levels of severity.	74

Chapter 4 - Operation

Exhibit 4-1.	Conversion factors for passenger car equivalents (pce).	84
Exhibit 4-2.	Traffic flow parameters.	85
Exhibit 4-3.	Approach capacity of a single-lane roundabout.	87
Exhibit 4-4.	Approach capacity of a double-lane roundabout.	88

Exhibit 4-5.	Capacity reduction factors for short lanes.	89
Exhibit 4-6.	Capacity comparison of single-lane and double-lane roundabouts.	89
Exhibit 4-7.	Capacity reduction factor M for a single-lane roundabout assuming pedestrian priority.	90
Exhibit 4-8.	Capacity reduction factor M for a double-lane roundabout assuming pedestrian priority.	91
Exhibit 4-9.	Control delay as a function of capacity and circulating flow.	93
Exhibit 4-10.	95th-percentile queue length estimation.	95
Exhibit 4-11.	Summary of roundabout software products for operational analysis.	97

Chapter 5 - Safety

Exhibit 5-1.	Vehicle conflict points for "T" Intersections with single-lane approaches.	105
Exhibit 5-2.	Vehicle conflict point comparison for intersections with single-lane approaches.	106
Exhibit 5-3.	Improper lane-use conflicts in double-lane roundabouts.	107
Exhibit 5-4.	Improper turn conflicts in double-lane roundabouts.	108
Exhibit 5-5.	Pedestrian-vehicle conflicts at signalized intersections.	109
Exhibit 5-6.	Pedestrian-vehicle conflicts at single-lane roundabouts.	109
Exhibit 5-7.	Bicycle conflicts at conventional intersections.	110
Exhibit 5-8.	Bicycle conflicts at roundabouts.	111
Exhibit 5-9.	Average annual crash frequencies at 11 U.S. intersections converted to roundabouts.	112
Exhibit 5-10.	Mean crash reductions in various countries.	112
Exhibit 5-11.	Reported proportions of major crash types at roundabouts.	113
Exhibit 5-12.	Comparison of collision types at roundabouts.	114
Exhibit 5-13.	Graphical depiction of collision types at roundabouts.	115
Exhibit 5-14.	Accident percentage per type of user urban roundabouts in 15 towns in western France.	116
Exhibit 5-15.	British crash rates for pedestrians at roundabouts and signalized intersections.	117
Exhibit 5-16.	Percentage reduction in the number of accidents by mode at 181 converted Dutch roundabouts.	117

Exhibit 5-17.	British crash rates (crashes per million trips) for bicyclists and motorcyclists at roundabouts and signalized intersections.	120
Exhibit 5-18.	A comparison of crashes between signalized and roundabout intersections in 1998 in 15 French towns.	120

Chapter 6 - Geometric Design

Exhibit 6-1.	Basic geometric elements of a roundabout.	131
Exhibit 6-2.	Roundabout design process.	131
Exhibit 6-3.	Sample theoretical speed profile (urban compact roundabout).	133
Exhibit 6-4.	Recommended maximum entry design speeds.	133
Exhibit 6-5.	Fastest vehicle path through single-lane roundabout.	134
Exhibit 6-6.	Fastest vehicle path through double-lane roundabout.	135
Exhibit 6-7.	Example of critical right-turn movement.	135
Exhibit 6-8.	Side friction factors at various speeds (metric units).	137
Exhibit 6-9.	Side friction factors at various speeds (U.S. customary units).	137
Exhibit 6-10.	Speed-radius relationship (metric units).	138
Exhibit 6-11.	Speed-radius relationship (U.S. customary units).	138
Exhibit 6-12.	Vehicle path radii.	139
Exhibit 6-13.	Approximated R_d values and corresponding R_l values (metric units).	141
Exhibit 6-14.	Approximated R_d values and corresponding R_l values (U.S. customary units).	141
Exhibit 6-15.	Through-movement swept path of WB-15 (WB-50) vehicle.	143
Exhibit 6-16.	Left-turn and right-turn swept paths of WB-15 (WB-50) vehicle.	143
Exhibit 6-17.	Key dimensions of nonmotorized design users.	144
Exhibit 6-18.	Radial alignment of entries.	145
Exhibit 6-19.	Recommended inscribed circle diameter ranges.	146
Exhibit 6-20.	Approach widening by adding full lane.	148
Exhibit 6-21.	Approach widening by entry flaring.	148
Exhibit 6-22.	Minimum circulatory lane widths for two-lane roundabouts.	150

Exhibit 6-23.	Example of central island with a traversable apron.	151
Exhibit 6-24.	Single-lane roundabout entry design.	153
Exhibit 6-25.	Single-lane roundabout exit design.	154
Exhibit 6-26.	Minimum splitter island dimensions.	157
Exhibit 6-27.	Minimum splinter island nose radii and offsets.	158
Exhibit 6-28.	Design values for stopping sight distance.	159
Exhibit 6-29.	Approach sight distance.	160
Exhibit 6-30.	Sight distance on circulatory roadway.	160
Exhibit 6-31.	Sign distance to crosswalk on exit.	161
Exhibit 6-32.	Intersection sight distance.	162
Exhibit 6-33.	Computed length of conflicting leg of intersection sight triangle.	163
Exhibit 6-34.	Sample plan view.	164
Exhibit 6-35.	Sample approach profile.	165
Exhibit 6-36.	Sample central island profile.	165
Exhibit 6-37.	Typical circulatory roadway section.	166
Exhibit 6-38.	Typical section with a truck apron.	166
Exhibit 6-39.	Provisions for bicycles.	168
Exhibit 6-40.	Sidewalk treatments.	169
Exhibit 6-41.	Example of right-turn bypass lane.	170
Exhibit 6-42.	Configuration of right-turn bypass lane with acceleration lane.	171
Exhibit 6-43.	Configuration of right-turn bypass lane with yield at exit leg.	172
Exhibit 6-44.	Sketched natural paths through a double-lane roundabout.	173
Exhibit 6-45.	Path overlap at a double-lane roundabout.	174
Exhibit 6-46.	One method of entry design to avoid path overlap at double-lane roundabouts.	175
Exhibit 6-47.	Alternate method of entry design to avoid path overlap at double-lane roundabouts.	175
Exhibit 6-48.	Extended splitter island treatment.	178
Exhibit 6-49.	Use of successive curves on high-speed approaches.	179
Exhibit 6-50.	Example of mini-roundabout.	180

Chapter 7 - Traffic Design and Landscaping

Exhibit 7-1.	YIELD sign (R1-2).	186
Exhibit 7-2.	ONE WAY sign (R6-1R).	186
Exhibit 7-3.	KEEP RIGHT sign (R4-7).	186
Exhibit 7-4.	Lane-use control signing for roundabouts with double-lane entries.	188
Exhibit 7-5.	Lane-use control signing for roundabouts with heavy turning traffic.	188
Exhibit 7-6.	Circular Intersection sign (W2-6).	189
Exhibit 7-7.	Advisory speed plate (W13-1).	189
Exhibit 7-8.	Roundabout Ahead Sign.	189
Exhibit 7-9.	YIELD AHEAD sign (W3-2a).	189
Exhibit 7-10.	Large Arrow sign (W1-6).	190
Exhibit 7-11.	Chevron plate (W1-8a).	190
Exhibit 7-12.	Pedestrian Crossing sign (W11-2a).	190
Exhibit 7-13.	Examples of advance destination guide signs.	191
Exhibit 7-14.	Exit guide sign (D1-1).	192
Exhibit 7-15.	Sample signing plan for an urban roundabout.	193
Exhibit 7-16.	Sample signing plan for a rural roundabout.	194
Exhibit 7-17.	Examples of speed reduction treatments.	195
Exhibit 7-18.	Sample signing plan for a mini-roundabout.	196
Exhibit 7-19.	Examples of yield lines.	198
Exhibit 7-20.	Approach pavement markings.	199
Exhibit 7-21.	Sample pavement marking plan for a mini-roundabout.	201
Exhibit 7-22.	Illumination of a roundabout.	202
Exhibit 7-23.	Recommended street illumination levels.	204
Exhibit 7-24.	Landscaping of the central island.	208

Chapter 8 - System Considerations

Exhibit 8-1.	Rail crossing treatments at roundabouts.	216
Exhibit 8-2.	Methods for accommodating a rail crossing adjacent to a roundabout.	217
Exhibit 8.3.	Example of closely spaced offset T-intersections with roundabouts.	218
Exhibit 8-4.	Through bypass lanes at staggered T-intersections.	218
Exhibit 8-5.	Two-bridge roundabout interchange.	219
Exhibit 8-6.	Example of two-bridge roundabout interchanges.	220
Exhibit 8-7.	Examples of one-bridge roundabout interchanges with circular central islands.	221
Exhibit 8.8.	One-bridge roundabout interchange with raindrop-shaped central islands.	222
Exhibit 8-9.	Roundabouts in an arterial network.	223
Exhibit 8-10.	Wide nodes and narrow roads.	226
Exhibit 8-11.	Summary of simulation models for roundabout analysis.	228

Photo Credits

Barry Crown: Exhibits 8-6, 8-7

Ken Courage: Exhibit 1-5 (g, Portland)

Lee Rodegerdts: Exhibits 1-5 (all except g, Portland), 1-6 (all except Fort Pierce), 2-4 (all except Fort Pierce), 3-3, 3-4, 6-23, 6-42, 7-10 (all), 7-11 (all), 7-14 (all), 7-16 (all), 7-22, 8-7, 8-8, 8-9, C-3 (a, d-i, k-n)

Paul Ryus: Exhibits 1-6 (Fort Pierce), 2-4 (Fort Pierce), C-3 (b, c, j)

1

Introduction

1.1	Scope of the Guide	2
1.2	Organization of the Guide	3
1.3	Defining Physical Features	5
1.4	Key Dimensions	5
1.5	Distinguishing Roundabouts from Other Circular Intersections	8
1.6	Roundabout Categories	12
1.6.1	Comparison of roundabout categories	13
1.6.2	Mini-roundabouts	14
1.6.3	Urban compact roundabouts	15
1.6.4	Urban single-lane roundabouts	16
1.6.5	Urban double-lane roundabouts	17
1.6.6	Rural single-lane roundabouts	18
1.6.7	Rural double-lane roundabouts	19
1.7	References	20
Exhibit 1-1.	Drawing of key roundabout features.	6
Exhibit 1-2.	Description of key roundabout features.	6
Exhibit 1-3.	Drawing of key roundabout dimensions.	7
Exhibit 1-4.	Description of key roundabout dimensions.	7
Exhibit 1-5.	Comparison of roundabouts with traffic circles.	8
Exhibit 1-6.	Common design elements at roundabouts.	10
Exhibit 1-7.	Basic design characteristics for each of the six roundabout categories.	13
Exhibit 1-8.	Typical mini-roundabout.	14
Exhibit 1-9.	Typical urban compact roundabout.	15
Exhibit 1-10.	Typical urban single-lane roundabout.	16
Exhibit 1-11.	Typical urban double-lane roundabout.	17
Exhibit 1-12.	Typical rural single-lane roundabout.	18
Exhibit 1-13.	Typical rural double-lane roundabout.	19

Chapter 1 Introduction

Circular intersections were first introduced in the U.S. in 1905.

Traffic circles have been part of the transportation system in the United States since 1905, when the Columbus Circle designed by William Phelps Eno opened in New York City. Subsequently, many large circles or rotaries were built in the United States. The prevailing designs enabled high-speed merging and weaving of vehicles. Priority was given to entering vehicles, facilitating high-speed entries. High crash experience and congestion in the circles led to rotaries falling out of favor in America after the mid-1950's. Internationally, the experience with traffic circles was equally negative, with many countries experiencing circles that locked up as traffic volumes increased.

The modern roundabout was developed in the United Kingdom in the 1960's.

The modern roundabout was developed in the United Kingdom to rectify problems associated with these traffic circles. In 1966, the United Kingdom adopted a mandatory "give-way" rule at all circular intersections, which required entering traffic to give way, or yield, to circulating traffic. This rule prevented circular intersections from locking up, by not allowing vehicles to enter the intersection until there were sufficient gaps in circulating traffic. In addition, smaller circular intersections were proposed that required adequate horizontal curvature of vehicle paths to achieve slower entry and circulating speeds.

Modern roundabouts provide substantially better operational and safety characteristics than older traffic circles and rotaries.

These changes improved the safety characteristics of the circular intersections by reducing the number and particularly the severity of collisions. Thus, the resultant modern roundabout is significantly different from the older style traffic circle both in how it operates and in how it is designed. The modern roundabout represents a substantial improvement, in terms of operations and safety, when compared with older rotaries and traffic circles (1, 2, 3). Therefore, many countries have adopted them as a common intersection form and some have developed extensive design guides and methods to evaluate the operational performance of modern roundabouts.

1.1 Scope of the Guide

This guide provides information and guidance on roundabouts, resulting in designs that are suitable for a variety of typical conditions in the United States. The scope of this guide is to provide general information, planning techniques, evaluation procedures for assessing operational and safety performance, and design guidelines for roundabouts.

International consensus has not been achieved on some aspects of roundabout design.

This guide has been developed with the input from transportation practitioners and researchers from around the world. In many cases, items from national and international practice and research indicate considerable consensus, and these items have been included in this guide. However, other items have generated considerable differences of opinion (e.g., methods of estimating capacity), and some practices vary considerably from country to country (e.g., marking of the circulatory roadway in multilane roundabouts). Where international consensus is not apparent, a reasoned approach is presented that the authors believe is currently most appropriate for the United States. As more roundabouts are built, the opportunity to conduct research to refine—or develop better—methods will enable future editions of this guide to improve.

Despite the comprehensive nature of this document, it cannot discuss every issue related to roundabouts. In particular, it does not represent the following topics:

- *Nonmountable traffic calming circles.* These are small traffic circles with raised central islands. They are typically used on local streets for speed and volume control. They are typically not designed to accommodate large vehicles, and often left-turning traffic is required to turn left in front of the circle. Mini-roundabouts, which are presented, may be an appropriate substitute.
- *Specific legal or policy requirements and language.* The legal information that is provided in this guide is intended only to make the reader aware of potential issues. The reader is encouraged to consult with an attorney on specific legal issues before adopting any of the recommendations contained herein. Similarly, regarding policy information, the guide refers to or encompasses applicable policies, such as those of the American Association of State Highway and Transportation Officials (AASHTO) (4). It does not, however, establish any new policies.
- *Roundabouts with more than two entry lanes on an approach.* While acknowledging the existence and potential of such large roundabouts, the guide does not provide specific guidance on the analysis or design of such roundabouts. However, the design principles contained in this document are also applicable to larger roundabouts. The relative safety advantages of roundabout intersections diminish at high traffic flows, particularly with regard to pedestrians and bicyclists. The advantages of larger roundabouts are their higher capacities that may make them attractive alternatives at sites with high traffic volumes. More intricate design is required to ensure adequate operational and safety performance. Therefore, expert operations and design advice should be sought and roundabout analysis software should be utilized in such circumstances. As users and designers in the United States become more familiar with roundabouts, this experience may then be extended to such applications.

Topics not discussed in this guide.

1.2 Organization of the Guide

This guide has been structured to address the needs of a variety of readers including the general public, policy-makers, transportation planners, operations and safety analysts, conceptual and detailed designers. This chapter distinguishes roundabouts from other traffic circles and defines the types of roundabouts addressed in the remainder of the guide. The remaining chapters in this guide generally increase in the level of detail provided.

Chapter 2—Policy Considerations: This chapter provides a broad overview of the performance characteristics of roundabouts. The costs associated with roundabouts versus other forms of intersections, legal issues, and public involvement techniques are discussed.

Chapter 3—Planning: This chapter discusses general guidelines for identifying appropriate intersection control options, given daily traffic volumes, and procedures for evaluating the feasibility of a roundabout at a given location. Chapters 2 and 3 provide sufficient detail to enable a transportation planner to decide under which circumstances roundabouts are likely to be appropriate, and how they compare to alternatives at a specific location.

Chapter 4—Operational Analysis: Methods are presented for analyzing the operational performance of each category of roundabout in terms of capacity, delay, and queuing.

Chapter 5—Safety: This chapter discusses the expected safety performance of roundabouts.

Chapter 6—Geometric Design: Specific geometric design principles for roundabouts are presented. The chapter then discusses each design element in detail, along with appropriate parameters to use for each type of roundabout.

Chapter 7—Traffic Design and Landscaping: This chapter discusses a number of traffic design aspects once the basic geometric design has been established. These include signs, pavement markings, and illumination. In addition, the chapter provides discussion on traffic maintenance during construction and landscaping.

Chapter 8—System Considerations: This chapter discusses specific issues and treatments that may arise from the systems context of a roundabout. The material may be of interest to transportation planners as well as operations and design engineers. Signal control at roundabouts is discussed. The chapter then considers the issue of rail crossings through the roundabout or in close proximity. Roundabouts in series with other roundabouts are discussed, including those at freeway interchanges and those in signalized arterial networks. Finally, the chapter presents simulation models as supplementary operational tools capable of evaluating roundabout performance within an overall roadway system.

Appendices: Three appendices are provided to expand upon topics in certain chapters. Appendix A provides information on the capacity models in Chapter 4. Appendix B provides design templates for each of the categories of roundabout described in Chapter 1, assuming four perpendicular legs. Appendix C provides information on the alternative signing and pavement marking in Chapter 7.

Margin notes have been used to highlight important points.

Several typographical devices have been used to enhance the readability of the guide. Margin notes, such as the note next to this paragraph, highlight important points or identify cross-references to other chapters of the guide. References have been listed at the end of each chapter and have been indicated in the text using numbers in parentheses, such as: (3). New terms are presented in *italics* and are defined in the glossary at the end of the document.

1.3 Defining Physical Features

A roundabout is a type of circular intersection, but not all circular intersections can be classified as roundabouts. In fact, there are at least three distinct types of circular intersections:

- *Rotaries* are old-style circular intersections common to the United States prior to the 1960's. Rotaries are characterized by a large diameter, often in excess of 100 m (300 ft). This large diameter typically results in travel speeds within the circulatory roadway that exceed 50 km/h (30 mph). They typically provide little or no horizontal deflection of the paths of through traffic and may even operate according to the traditional "yield-to-the-right" rule, i.e., circulating traffic yields to entering traffic.
- *Neighborhood traffic circles* are typically built at the intersections of local streets for reasons of traffic calming and/or aesthetics. The intersection approaches may be uncontrolled or stop-controlled. They do not typically include raised channelization to guide the approaching driver onto the circulatory roadway. At some traffic circles, left-turning movements are allowed to occur to the left of (clockwise around) the central island, potentially conflicting with other circulating traffic.
- *Roundabouts* are circular intersections with specific design and traffic control features. These features include yield control of all entering traffic, channelized approaches, and appropriate geometric curvature to ensure that travel speeds on the circulatory roadway are typically less than 50 km/h (30 mph). Thus, roundabouts are a subset of a wide range of circular intersection forms.

To more clearly identify the defining characteristics of a roundabout, consistent definitions for each of the key features, dimensions, and terms are used throughout this guide. Exhibit 1-1 is a drawing of a typical roundabout, annotated to identify the key features. Exhibit 1-2 provides a description of each of the key features.

1.4 Key Dimensions

For operational analysis and design purposes, it is useful to define a number of key dimensions. Exhibit 1-3 shows a number of key dimensions that are described in Exhibit 1-4. Note that these exhibits do not present all of the dimensions needed in the detailed analysis and design of roundabouts; these will be presented and defined in later chapters as needed.

Types of circular intersections.

Key roundabout features include:

- **Yield control of entering traffic**
- **Channelized approaches**
- **Appropriate geometric curvature to slow speeds**

Exhibit 1-1. Drawing of key roundabout features.

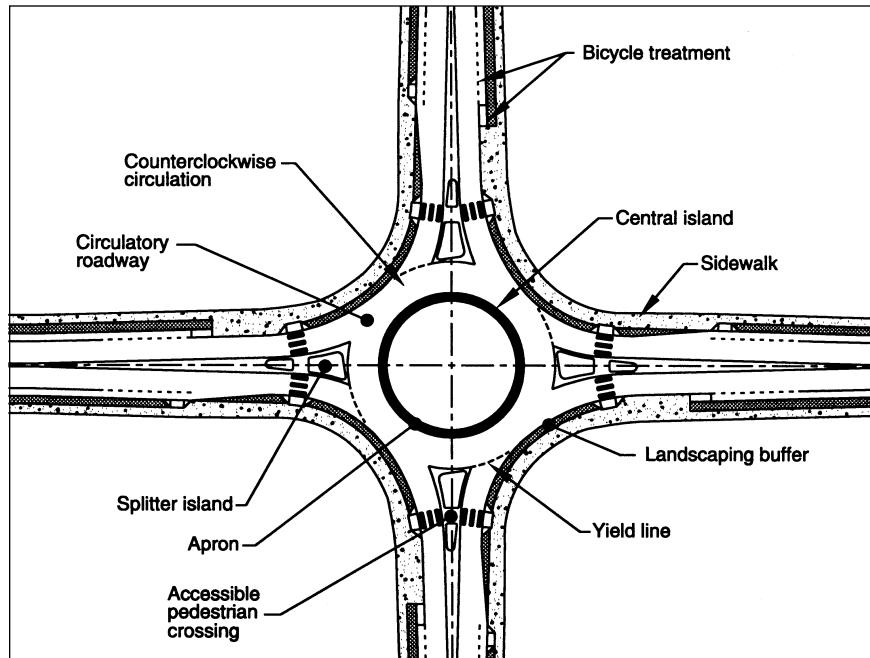

Splitter islands have multiple roles. They:

- Separate entering and exiting traffic
- Deflect and slow entering traffic
- Provide a pedestrian refuge

Exhibit 1-2. Description of key roundabout features.

Feature	Description
Central island	The <i>central island</i> is the raised area in the center of a roundabout around which traffic circulates.
Splitter island	A <i>splitter island</i> is a raised or painted area on an approach used to separate entering from exiting traffic, deflect and slow entering traffic, and provide storage space for pedestrians crossing the road in two stages.
Circulatory roadway	The <i>circulatory roadway</i> is the curved path used by vehicles to travel in a counter-clockwise fashion around the central island
Apron	If required on smaller roundabouts to accommodate the wheel tracking of large vehicles, an <i>apron</i> is the mountable portion of the central island adjacent to the circulatory roadway.
Yield line	A <i>yield line</i> is a pavement marking used to mark the point of entry from an approach into the circulatory roadway and is generally marked along the inscribed circle. Entering vehicles must yield to any circulating traffic coming from the left before crossing this line into the circulatory roadway.
Accessible pedestrian crossings	<i>Accessible pedestrian crossings</i> should be provided at all roundabouts. The crossing location is set back from the yield line, and the splitter island is cut to allow pedestrians, wheelchairs, strollers, and bicycles to pass through.
Bicycle treatments	<i>Bicycle treatments</i> at roundabouts provide bicyclists the option of traveling through the roundabout either as a vehicle or as a pedestrian, depending on the bicyclist's level of comfort.
Landscaping buffer	<i>Landscaping buffers</i> are provided at most roundabouts to separate vehicular and pedestrian traffic and to encourage pedestrians to cross only at the designated crossing locations. Landscaping buffers can also significantly improve the aesthetics of the intersection.

Exhibit 1-3. Drawing of key roundabout dimensions.

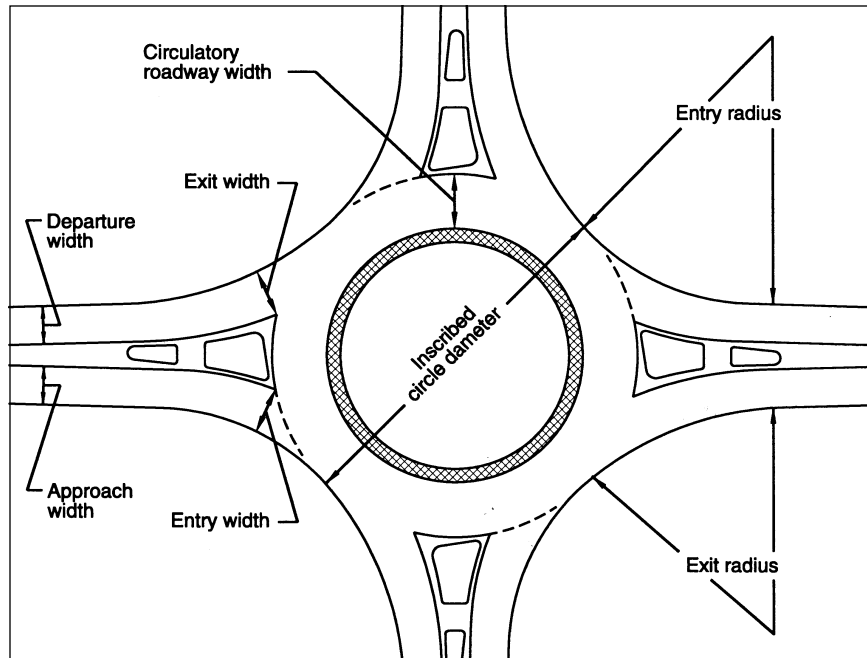

Exhibit 1-4. Description of key roundabout dimensions.

Dimension	Description
Inscribed circle diameter	The <i>inscribed circle diameter</i> is the basic parameter used to define the size of a roundabout. It is measured between the outer edges of the circulatory roadway.
Circulatory roadway width	The <i>circulatory roadway width</i> defines the roadway width for vehicle circulation around the central island. It is measured as the width between the outer edge of this roadway and the central island. It does not include the width of any mountable apron, which is defined to be part of the central island.
Approach width	The <i>approach width</i> is the width of the roadway used by approaching traffic upstream of any changes in width associated with the roundabout. The approach width is typically no more than half of the total width of the roadway.
Departure width	The <i>departure width</i> is the width of the roadway used by departing traffic downstream of any changes in width associated with the roundabout. The departure width is typically less than or equal to half of the total width of the roadway.
Entry width	The <i>entry width</i> defines the width of the entry where it meets the inscribed circle. It is measured perpendicularly from the right edge of the entry to the intersection point of the left edge line and the inscribed circle.
Exit width	The <i>exit width</i> defines the width of the exit where it meets the inscribed circle. It is measured perpendicularly from the right edge of the exit to the intersection point of the left edge line and the inscribed circle.
Entry radius	The <i>entry radius</i> is the minimum radius of curvature of the outside curb at the entry.
Exit radius	The <i>exit radius</i> is the minimum radius of curvature of the outside curb at the exit.

1.5 Distinguishing Roundabouts from Other Circular Intersections

Circular intersections that do not conform to the characteristics of modern roundabouts are called “traffic circles” in this guide.

Since the purpose of this guide is to assist in the planning, design, and performance evaluation of roundabouts, not other circular intersections, it is important to be able to distinguish between them. Since these distinctions may not always be obvious, the negative aspects of rotaries or neighborhood traffic circles (hereafter referred to as “*traffic circles*”) may be mistaken by the public for a roundabout. Therefore, the ability to carefully distinguish roundabouts from traffic circles is important in terms of public understanding.

How then does one distinguish a roundabout from other forms of circular intersection? Exhibit 1-5 identifies some of the major characteristics of roundabouts and contrasts them with other traffic circles. Note that some of the traffic circles shown have many of the features associated with roundabouts but are deficient in one or more critical areas. Note also that these characteristics apply to yield-controlled roundabouts; signalized roundabouts are a special case discussed in Chapter 8.

Exhibit 1-5. Comparison of roundabouts with traffic circles.

Roundabouts must have all of the characteristics listed in the left column.

Chapter 8 discusses signalization at roundabouts.

Roundabouts



(a) Traffic control

Yield control is used on all entries. The circulatory roadway has no control. *Santa Barbara, CA*

Traffic Circles



Some traffic circles use stop control, or no control, on one or more entries. *Hagerstown, MD*



(b) Priority to circulating vehicles

Circulating vehicles have the right-of-way. *Santa Barbara, CA*

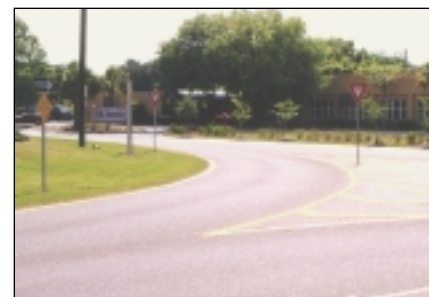

Some traffic circles require circulating traffic to yield to entering traffic. *Sarasota, FL*

Roundabouts

Traffic Circles

Exhibit 1-5. (continued).
Comparison of roundabouts
with traffic circles.



(c) Pedestrian access

Pedestrian access is allowed only across the legs of the roundabout, behind the yield line. *Santa Barbara, CA*



Some traffic circles allow pedestrian access to the central island. *Sarasota, FL*



(d) Parking

No parking is allowed within the circulatory roadway or at the entries. *Avon, CO*



Some traffic circles allow parking within the circulatory roadway. *Sarasota, FL*



(e) Direction of circulation

All vehicles circulate counter-clockwise and pass to the right of the central island. *Naples, FL*



Some neighborhood traffic circles allow left-turning vehicles to pass to the left of the central island. *Portland, OR*



All traffic circulates counter-clockwise around a roundabouts central island.

In addition to the design elements identified in Exhibit 1-5, roundabouts often include one or more additional design elements intended to enhance the safety and/or capacity of the intersection. However, their absence does not necessarily preclude an intersection from operating as a roundabout. These additional elements are identified in Exhibit 1-6.

Exhibit 1-6. Common design elements at roundabouts.

Roundabouts may have these additional design features.

Characteristic	Description
-----------------------	--------------------

(a) Adequate speed reduction	 <p>Good roundabout design requires entering vehicles to negotiate a small enough radius to slow speeds to no greater than 50 km/h (30 mph). Once within the circulatory roadway, vehicles' paths are further deflected by the central island. <i>West Boca Raton, FL</i></p>  <p>Some roundabouts allow high-speed entries for major movements. This increases the risk for more severe collisions for vehicles, bicycles, and pedestrians. <i>Bradenton Beach, FL</i></p>
-------------------------------------	--



Characteristic

Description

(b) Design vehicle



Good roundabout design makes accommodation for the appropriate design vehicle. For small roundabouts, this may require the use of an apron. *Lothian, MD*



Some roundabouts are too small to accommodate large vehicles that periodically approach the intersection. *Naples, FL*

(c) Entry flare



Flare on an entry to a roundabout is the widening of an approach to multiple lanes to provide additional capacity and storage at the yield line. *Long Beach, CA*

Exhibit 1-6 (continued).
Common design elements
at roundabouts.

Aprons can be used in small roundabouts to accommodate the occasional large vehicle that may use the intersection.

Exhibit 1-6 (continued).
Common design elements at
roundabouts.

Characteristic	Description
-----------------------	--------------------

(d) Splitter island	
----------------------------	--



All except mini-roundabouts have raised splitter islands. These are designed to separate traffic moving in opposite directions, deflect entering traffic, and to provide opportunities for pedestrians to cross in two stages. Mini-roundabouts may have splitter islands defined only by pavement markings. *Tavares, FL*

(e) Pedestrian crossing locations	
--	---



Pedestrian crossings are located at least one vehicle length upstream of the yield point. *Fort Pierce, FL*

1.6 Roundabout Categories

For the purposes of this guide, roundabouts have been categorized according to size and environment to facilitate discussion of specific performance or design issues. There are six basic categories based on environment, number of lanes, and size:

This guide uses six basic roundabout categories.

- Mini-roundabouts
- Urban compact roundabouts
- Urban single-lane roundabouts
- Urban double-lane roundabouts
- Rural single-lane roundabouts
- Rural double-lane roundabouts

Multilane roundabouts with more than two approach lanes are possible, but not explicitly covered in this guide.

Multilane roundabouts with more than two approach lanes are possible, but they are not covered explicitly by this guide, although many of the design principles contained in this guide would still apply. For example, the guide provides guidance on the

design of flaring approaches from one to two lanes. Although not explicitly discussed, this guidance could be extended to the design of larger roundabout entries.

Note that separate categories have not been explicitly identified for suburban environments. Suburban settings may combine higher approach speeds common in rural areas with multimodal activity that is more similar to urban settings. Therefore, they should generally be designed as urban roundabouts, but with the high-speed approach treatments recommended for rural roundabouts.

In most cases, designers should anticipate the needs of pedestrians, bicyclists, and large vehicles. Whenever a raised splitter island is provided, there should also be an at-grade pedestrian refuge. In this case, the pedestrian crossing facilitates two separate moves: curb-to-island and island-to-curb. The exit crossing will typically require more vigilance from the pedestrian and motorist than the entry crossing. Further, it is recommended that all urban crosswalks be marked. Under all urban design categories, special attention should be given to assist pedestrian users who are visually impaired or blind, through design elements. For example, these users typically attempt to maintain their approach alignment to continue across a street in the crosswalk, since the crosswalk is often a direct extension of the sidewalk. A roundabout requires deviation from that alignment, and attention needs to be given to providing appropriate informational cues to pedestrians regarding the location of the sidewalk and the crosswalk, even at mini-roundabouts. For example, appropriate landscaping is one method of providing some information. Another is to align the crosswalk ramps perpendicular to the pedestrian's line of travel through the pedestrian refuge.

Suburban roundabouts incorporate elements of both urban and rural roundabouts.

Roundabout design should generally accommodate pedestrian, bicycle, and large vehicle use.

1.6.1 Comparison of roundabout categories

Exhibit 1-7 summarizes and compares some fundamental design and operational elements for each of the six roundabout categories developed for this guide. The following sections provide a qualitative discussion of each category.

Exhibit 1-7. Basic design characteristics for each of the six roundabout categories.

Design Element	Mini-Roundabout	Urban Compact	Urban Single-Lane	Urban Double-Lane	Rural Single-Lane	Rural Double-Lane
Recommended maximum entry design speed	25 km/h (15 mph)	25 km/h (15 mph)	35 km/h (20 mph)	40 km/h (25 mph)	40 km/h (25 mph)	50 km/h (30 mph)
Maximum number of entering lanes per approach	1	1	1	2	1	2
Typical inscribed circle diameter ¹	13 m to 25 m (45 ft to 80 ft)	25 to 30 m (80 to 100 ft)	30 to 40 m (100 to 130 ft)	45 to 55 m (150 to 180 ft)	35 to 40 m (115 to 130 ft)	55 to 60 m (180 to 200 ft)
Splitter island treatment	Raised if possible, crosswalk cut if raised	Raised, with crosswalk cut	Raised, with crosswalk cut	Raised, with crosswalk cut	Raised and extended, with crosswalk cut	Raised and extended, with crosswalk cut
Typical daily service volumes on 4-leg roundabout (veh/day)	10,000	15,000	20,000	Refer to Chapter 4 procedures	20,000	Refer to Chapter 4 procedures

1. Assumes 90-degree entries and no more than four legs.

Mini-roundabouts can be useful in low-speed urban environments with right-of-way constraints.

1.6.2 Mini-roundabouts

Mini-roundabouts are small roundabouts used in low-speed urban environments, with average operating speeds of 60km/h (35mph) or less. Exhibit 1-8 provides an example of a typical mini-roundabout. They can be useful in low-speed urban environments in cases where conventional roundabout design is precluded by right-of-way constraints. In retrofit applications, mini-roundabouts are relatively inexpensive because they typically require minimal additional pavement at the intersecting roads—for example, minor widening at the corner curbs. They are mostly recommended when there is insufficient right-of-way for an urban compact roundabout. Because they are small, mini-roundabouts are perceived as pedestrian-friendly with short crossing distances and very low vehicle speeds on approaches and exits. The mini-roundabout is designed to accommodate passenger cars without requiring them to drive over the central island. To maintain its perceived compactness and low speed characteristics, the yield lines are positioned just outside of the swept path of the largest expected vehicle. However, the central island is mountable, and larger vehicles may cross over the central island, but not to the left of it. Speed control around the mountable central island should be provided in the design by requiring horizontal deflection. Capacity for this type of roundabout is expected to be similar to that of the compact urban roundabout. The recommended design of these roundabouts is based on the German method, with some influence from the United Kingdom.

Exhibit 1-8. Typical mini-roundabout.

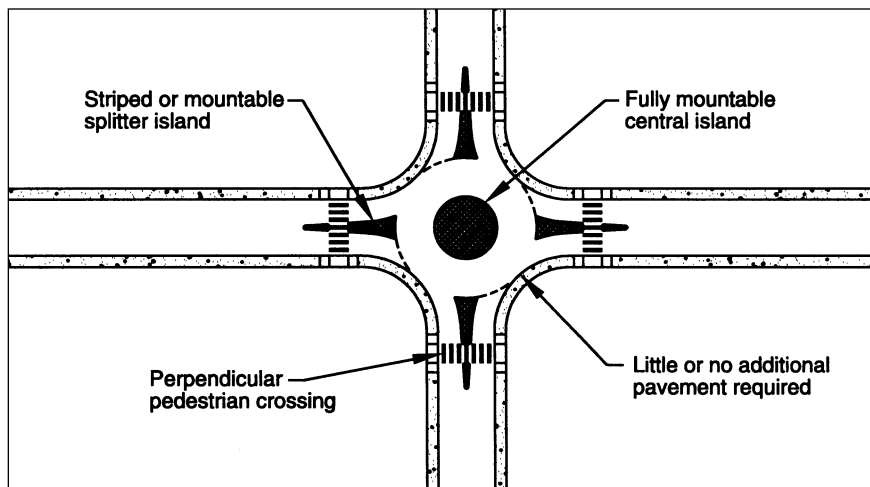

1.6.3 Urban compact roundabouts

Like mini-roundabouts, urban compact roundabouts are intended to be pedestrian- and bicyclist-friendly because their perpendicular approach legs require very low vehicle speeds to make a distinct right turn into and out of the circulatory roadway. All legs have single-lane entries. However, the urban compact treatment meets all the design requirements of effective roundabouts. The principal objective of this design is to enable pedestrians to have safe and effective use of the intersection. Capacity should not be a critical issue for this type of roundabout to be considered. The geometric design includes raised splitter islands that incorporate at-grade pedestrian storage areas, and a nonmountable central island. There is usually an apron surrounding the nonmountable part of the compact central island to accommodate large vehicles. The recommended design of these roundabouts is similar to those in Germany and other northern European countries. Exhibit 1-9 provides an example of a typical urban compact roundabout.

Urban compact roundabouts are intended to be pedestrian-friendly; capacity should not be a critical issue when considering this type.

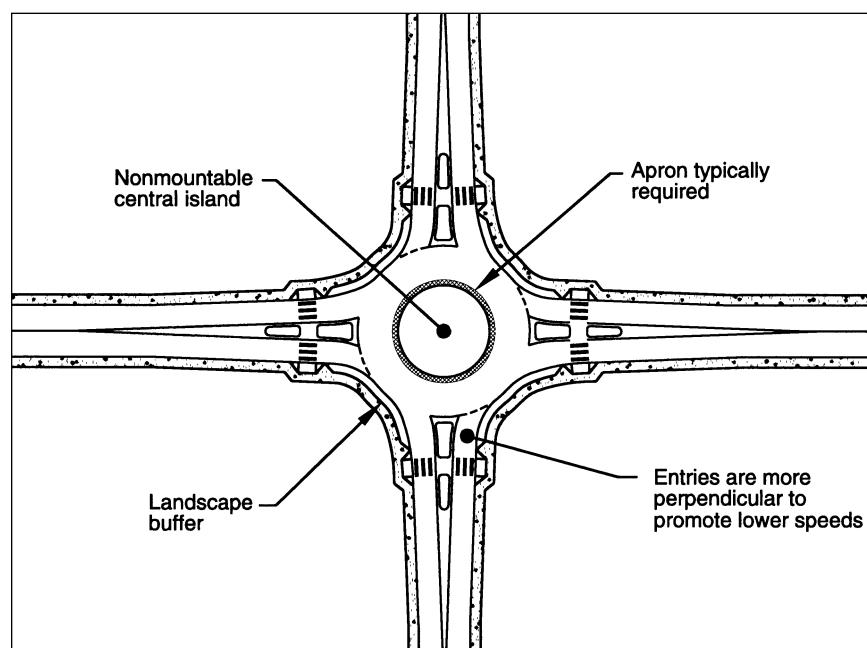

Exhibit 1-9. Typical urban compact roundabout.

1.6.4 Urban single-lane roundabouts

Urban single-lane roundabouts have slightly higher speeds and capacities than urban compact roundabouts.

The design focuses on consistent entering and exiting speeds.

This type of roundabout is characterized as having a single lane entry at all legs and one circulatory lane. Exhibit 1-10 provides an example of a typical urban single-lane roundabout. They are distinguished from urban compact roundabouts by their larger inscribed circle diameters and more tangential entries and exits, resulting in higher capacities. Their design allows slightly higher speeds at the entry, on the circulatory roadway, and at the exit. Notwithstanding the larger inscribed circle diameters than compact roundabouts, the speed ranges recommended in this guide are somewhat lower than those used in other countries, in order to enhance safety for bicycles and pedestrians. The roundabout design is focused on achieving consistent entering and circulating vehicle speeds. The geometric design includes raised splitter islands, a nonmountable central island, and preferably, no apron. The design of these roundabouts is similar to those in Australia, France, and the United Kingdom.

Exhibit 1-10. Typical urban single-lane roundabout.

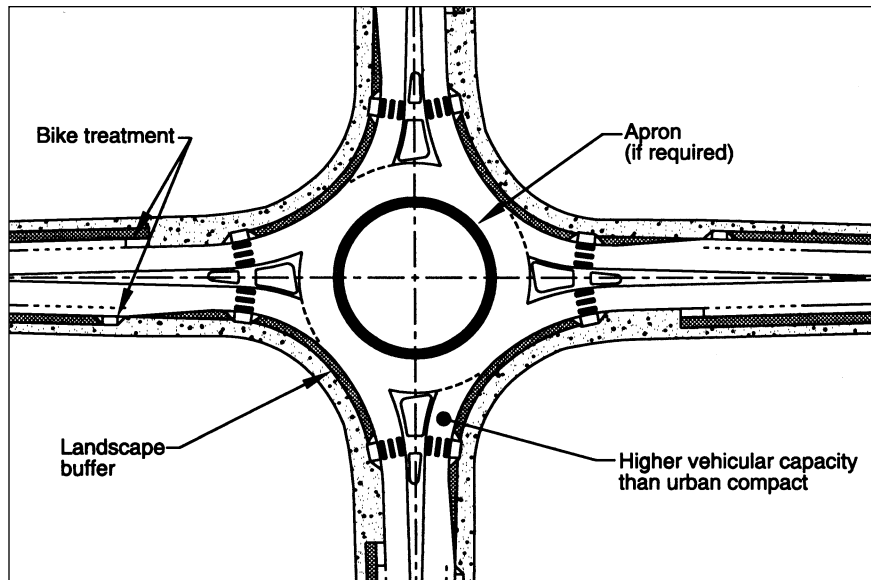

1.6.5 Urban double-lane roundabouts

Urban double-lane roundabouts include all roundabouts in urban areas that have at least one entry with two lanes. They include roundabouts with entries on one or more approaches that flare from one to two lanes. These require wider circulatory roadways to accommodate more than one vehicle traveling side by side. Exhibit 1-11 provides an example of a typical urban multilane roundabout. The speeds at the entry, on the circulatory roadway, and at the exit are similar to those for the urban single-lane roundabouts. Again, it is important that the vehicular speeds be consistent throughout the roundabout. The geometric design will include raised splitter islands, no truck apron, a nonmountable central island, and appropriate horizontal deflection.

Alternate routes may be provided for bicyclists who choose to bypass the roundabout. Bicycle and pedestrian pathways must be clearly delineated with sidewalk construction and landscaping to direct users to the appropriate crossing locations and alignment. Urban double-lane roundabouts located in areas with high pedestrian or bicycle volumes may have special design recommendations such as those provided in Chapters 6 and 7. The design of these roundabouts is based on the methods used in the United Kingdom, with influences from Australia and France.

The urban double-lane roundabout category includes roundabouts with one or more entries that flare from one to two lanes.

See Chapters 6 and 7 for special design considerations for pedestrians and bicycles.

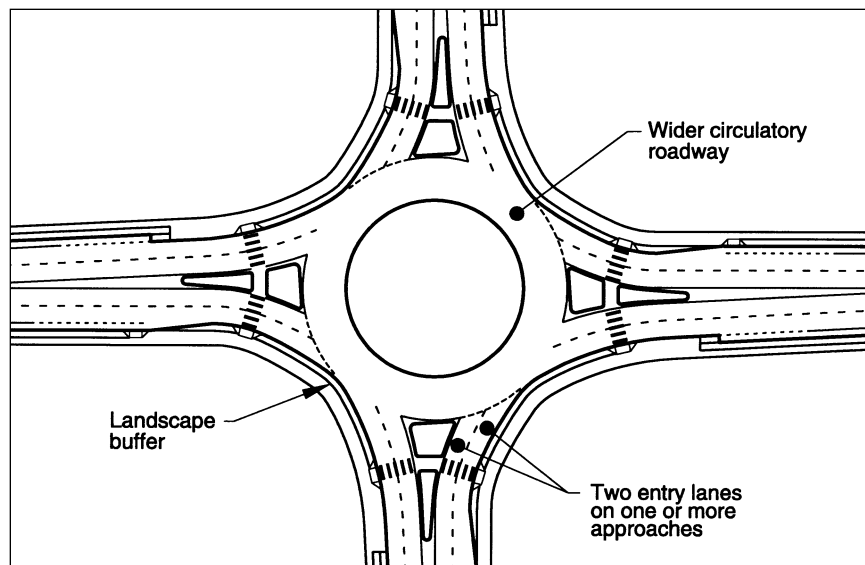

Exhibit 1-11. Typical urban double-lane roundabout.

1.6.6 Rural single-lane roundabouts

Because of their higher approach speeds, rural single-lane roundabouts require supplementary geometric and traffic control device treatments on the approaches.

Rural single-lane roundabouts generally have high average approach speeds in the range of 80 to 100 km/h (50 to 60 mph). They require supplementary geometric and traffic control device treatments on approaches to encourage drivers to slow to an appropriate speed before entering the roundabout. Rural roundabouts may have larger diameters than urban roundabouts to allow slightly higher speeds at the entries, on the circulatory roadway, and at the exits. This is possible if few pedestrians are expected at these intersections, currently and in future. There is preferably no apron because their larger diameters should accommodate larger vehicles. Supplemental geometric design elements include extended and raised splitter islands, a nonmountable central island, and adequate horizontal deflection. The design of these roundabouts is based primarily on the methods used by Australia, France, and the United Kingdom. Exhibit 1-12 provides an example of a typical rural single-lane roundabout.

Rural roundabouts that may become part of an urbanized area should include urban roundabout design features.

Rural roundabouts that may one day become part of an urbanized area should be designed as urban roundabouts, with slower speeds and pedestrian treatments. However, in the interim, they should be designed with supplementary approach and entry features to achieve safe speed reduction.

Exhibit 1-12. Typical rural single-lane roundabout.

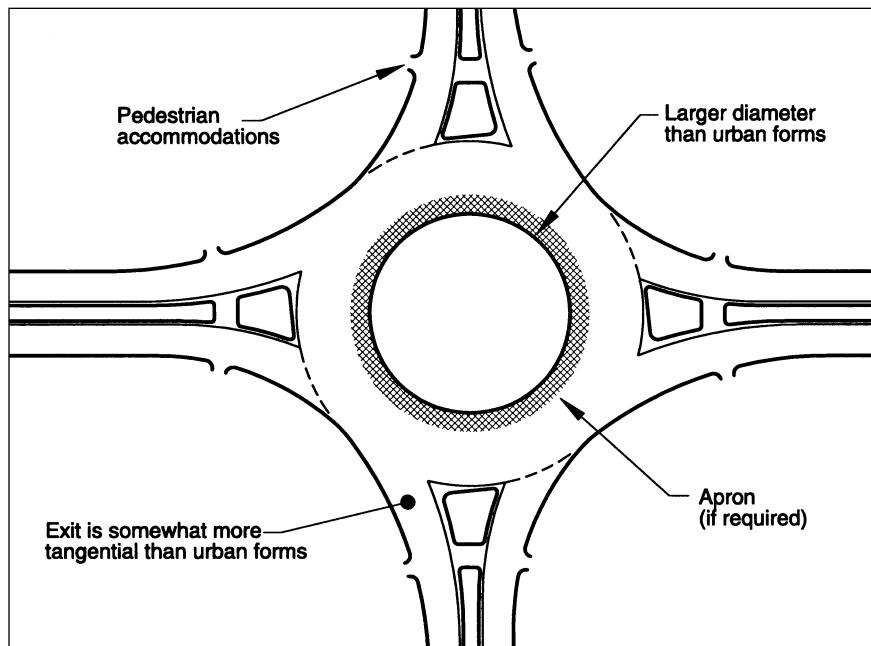

1.6.7 Rural double-lane roundabouts

Rural double-lane roundabouts have speed characteristics similar to rural single-lane roundabouts with average approach speeds in the range of 80 to 100 km/h (50 to 60 mph). They differ in having two entry lanes, or entries flared from one to two lanes, on one or more approaches. Consequently, many of the characteristics and design features of rural double-lane roundabouts mirror those of their urban counterparts. The main design differences are designs with higher entry speeds and larger diameters, and recommended supplementary approach treatments. The design of these roundabouts is based on the methods used by the United Kingdom, Australia, and France. Exhibit 1-13 provides an example of a typical rural double-lane roundabout. Rural roundabouts that may one day become part of an urbanized area should be designed for slower speeds, with design details that fully accommodate pedestrians and bicyclists. However, in the interim they should be designed with approach and entry features to achieve safe speed reduction.

Rural double-lane roundabouts have higher entry speeds and larger diameters than their urban counterparts.

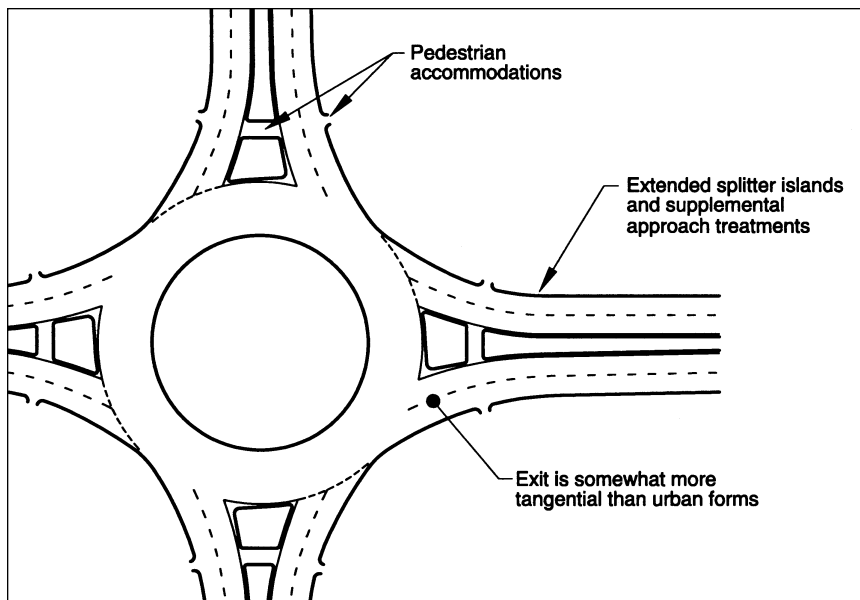

Exhibit 1-13. Typical rural double-lane roundabout.

1.7 References

1. Brown, M. *TRL State of the Art Review—The Design of Roundabouts*. London: HMSO, 1995.
2. Todd, K. "A history of roundabouts in Britain." *Transportation Quarterly*, Vol. 45, No. 1, January 1991.
3. Jacquemart, G. *Synthesis of Highway Practice 264: Modern Roundabout Practice in the United States*. National Cooperative Highway Research Program. Washington, D.C: National Academy Press, 1998.
4. American Association of State Highway and Transportation Officials (AASHTO). *A Policy on Geometric Design of Highways and Streets*. Washington, D.C.: AASHTO, 1994.



Policy Considerations

2.1	Characteristics	23
2.1.1	Safety	23
2.1.2	Vehicle delay and queue storage	28
2.1.3	Delay of major movements	28
2.1.4	Signal progression	29
2.1.5	Environmental factors	29
2.1.6	Spatial requirements	29
2.1.7	Operation and maintenance costs	30
2.1.8	Traffic calming	30
2.1.9	Aesthetics	30
2.1.10	Design for older drivers	31
2.2	Multimodal Considerations	32
2.2.1	Pedestrians	32
2.2.2	Bicycles	34
2.2.3	Large vehicles	34
2.2.4	Transit	35
2.2.5	Emergency vehicles	35
2.2.6	Rail crossings	35
2.3	Costs Associated with Roundabouts	36
2.4	Legal Considerations	37
2.4.1	Definition of “intersection”	37
2.4.2	Right-of-way between vehicles	38
2.4.3	Required lane position at intersections	38
2.4.4	Priority within the circulatory roadway	38
2.4.5	Pedestrian accessibility	39
2.4.6	Parking	40

2.5	Public Involvement	40
2.5.1	Public meetings	41
2.5.2	Informational brochures	41
2.5.3	Informational videos	43
2.5.4	Media announcements	43
2.6	Education	43
2.6.1	Driver education	43
2.6.2	Bicyclist education	47
2.6.3	Pedestrian education	47
2.7	References	48
Exhibit 2-1.	Average annual crash frequencies at 11 U.S. intersections converted to roundabouts.	23
Exhibit 2-2.	Pedestrian's chances of death if hit by a motor vehicle.	25
Exhibit 2-3.	Comparisons of vehicle-vehicle conflict points for intersections with four single-lane approaches.	26
Exhibit 2-4.	Fastest vehicle path through a double-lane roundabout.	27
Exhibit 2-5.	Examples of aesthetic treatments.	31
Exhibit 2-6.	Examples of informational brochures.	42
Exhibit 2-7.	Driving straight through a roundabout.	45
Exhibit 2-8.	Turning left at a roundabout.	46

Chapter 2 Policy Considerations

Roundabouts have unique characteristics that warrant consideration by developers and managers of the road system. This chapter provides a general overview of the characteristics of roundabouts and policy considerations pertaining to them. The information may be useful to policy makers and the general public. The reader is encouraged to refer to later chapters on the specifics associated with planning, operation, safety, and design of roundabouts.

2.1 Characteristics

The previous chapter described the physical features of a roundabout. This section describes performance characteristics that need to be considered, either at a policy level when introducing roundabouts into a region or at specific locations where a roundabout is one of the alternatives being considered.

2.1.1 Safety

This section provides an overview of the safety performance of roundabouts and then discusses the general characteristics that lead to this performance. It does not attempt to discuss all of the issues related to safety; the reader is encouraged to refer to Chapter 5 for a more detailed discussion.

Roundabouts are generally safer than other forms of intersection in terms of aggregate crash statistics for low and medium traffic capacity conditions (1). Injury crash rates for motor vehicle occupants are generally lower, although the proportion of single-vehicle crashes is typically higher. However, bicyclists and pedestrians are involved in a relatively higher proportion of injury accidents than they are at other intersections (2).

Roundabouts have been demonstrated to be generally safer for motor vehicles and pedestrians than other forms of at-grade intersections.

Exhibit 2-1 presents comparisons of before and after aggregate crash frequencies (average annual crashes per roundabout) involving users of eleven roundabouts constructed in the United States (3). The decrease in severe injury crashes is noteworthy. However, the “before” situation at these intersections required mitigation for safety. Therefore, some other feasible alternatives may also be expected to have resulted in a reduction in the crash frequencies. This study yielded insufficient data to draw conclusions regarding the safety of bicyclists and pedestrians.

Exhibit 2-1. Average annual crash frequencies at 11 U.S. intersections converted to roundabouts.

Type of roundabout	Sites	Before roundabout			Roundabout			Percent change		
		Total	Inj. ³	PDO ⁴	Total	Inj.	PDO	Total	Inj.	PDO
Single-Lane ¹	8	4.8	2.0	2.4	2.4	0.5	1.6	-51%	-73%	-32%
Multilane ²	3	21.5	5.8	15.7	15.3	4.0	11.3	-29%	-31%	-10%
Total	11	9.3	3.0	6.0	5.9	1.5	4.2	-37%	-51%	-29%

Notes:
 1. Mostly single-lane roundabouts with an inscribed circle diameter of 30 to 35 m (100 to 115 ft).
 2. Multilane roundabouts with an inscribed circle diameter greater than 50 m (165 ft).
 3. Inj. = Injury crashes.
 4. PDO = Property Damage Only crashes.
 Source: (3)

Good roundabout designs encourage speed reduction and speed consistency.

Good roundabout design places a high priority on speed reduction and speed consistency. Such designs require that vehicles negotiate the roundabout through a series of turning maneuvers at low speeds, generally less than 30 km/h (20 mph). Speed consistency refers to the design objective of slowing vehicles in stages down to the desired negotiating speed to be consistent with the expectations of drivers. Speed control is provided by geometric features, not only by traffic control devices or by the impedance of other traffic. Because of this, speed reduction can be achieved at all times of day. If achieved by good design, then in principle, lower vehicle speeds should provide the following safety benefits:

Potential safety benefits of low vehicle speeds.

- Reduce crash severity for pedestrians and bicyclists, including older pedestrians, children, and impaired persons;
- Provide more time for entering drivers to judge, adjust speed for, and enter a gap in circulating traffic;
- Allow safer merges into circulating traffic;
- Provide more time for all users to detect and correct for their mistakes or mistakes of others;
- Make collisions less frequent and less severe; and
- Make the intersection safer for novice users.

For example, Exhibit 2-2 shows that a pedestrian is about three times more likely to die when struck at 50 km/h (30 mph) than at 32 km/h (20 mph), across a range of only 18 km/h (10 mph) difference in speed (4). Typical commuter bicyclist speeds are in the range of 20 to 25 km/h (12 to 15 mph). Therefore, the difference in design speed is critical to all users who are not within the protective body of a motorized vehicle. The minor additional delay or inconvenience to drivers of lower-speed roundabout designs (as compared to higher-speed roundabout designs) is a tradeoff for the substantial safety benefit to pedestrians and bicyclists. Older drivers may benefit from the additional time to perceive, think, react, and correct for errors (as may all users). It should be clarified that there has been no specific research performed on older drivers, older pedestrians, and older bicyclists at roundabouts. It should also be noted that visually impaired pedestrians are not provided the audible cues from vehicle streams that are available at a signal controlled intersection. For example, at roundabout exits, it may be difficult to discern the sound of vehicles which will continue to circulate from those exiting the roundabout. Therefore, information needs to be provided to these users through various appropriate design features to assist them in safely locating and navigating the crossings at roundabouts.

Visually impaired pedestrians are not provided with audible cues from vehicle streams.

Lower circulating speeds can provide greater capacity.

Furthermore, the operational efficiency (capacity) of roundabouts is probably greater at lower circulating speed, because of these two phenomena:

- The faster the circulating traffic, the larger the gaps that entering traffic will comfortably accept. This translates to fewer acceptable gaps and therefore more instances of entering vehicles stopping at the yield line.
- Entering traffic, which is first stopped at the yield line, requires even larger gaps in the circulating traffic in order to accelerate and merge with the circulating traffic. The faster the circulating traffic, the larger this gap must be. This translates into even fewer acceptable gaps and therefore longer delays for entering traffic.

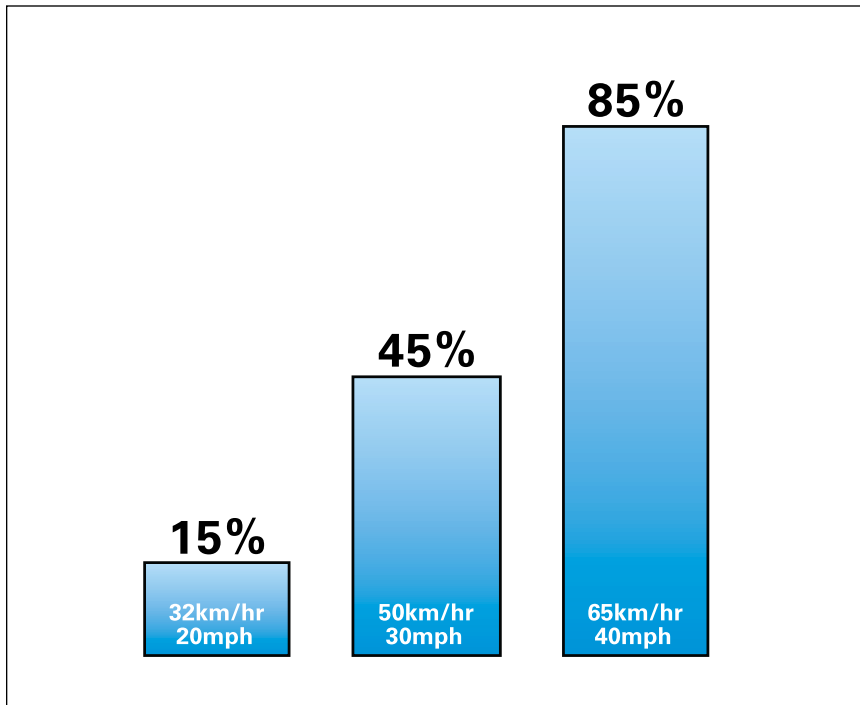

Source: United Kingdom (4)

Exhibit 2-2. Pedestrian's chances of death if hit by a motor vehicle.

2.1.1.1 Single-lane roundabouts

The safety characteristics of single-lane and multilane roundabouts are somewhat different and are discussed separately. Single-lane roundabouts are the simplest form of roundabout and thus are a good starting point for discussing the safety characteristics of roundabouts relative to other forms of intersections.

The *frequency* of crashes at an intersection is related to the number of *conflict points* at an intersection, as well as the magnitude of conflicting flows at each conflict point. A conflict point is a location where the paths of two vehicles, or a vehicle and a bicycle or pedestrian diverge, merge, or cross each other. For example, Exhibit 2-3 presents a diagram of vehicle-vehicle conflict points for a traditional four-leg intersection and a four-leg roundabout intersection of two-lane roads. The number of vehicle-vehicle conflict points for four-leg intersections drops from thirty-two to eight with roundabouts, a 75 percent decrease. Fewer conflict points means fewer opportunities for collisions. These are not the only conflict points at roundabouts or traditional intersections, but are illustrative of the differences between intersection types. Chapter 5 contains a more detailed comparison of conflicts at more complex intersections and for pedestrians and bicyclists.

The *severity* of a collision is determined largely by the speed of impact and the angle of impact. The higher the speed, the more severe the collision. The higher the angle of impact, the more severe the collision. Roundabouts reduce in severity or eliminate many severe conflicts that are present in traditional intersections.

Roundabouts bring the simplicity of a "T" intersection to intersections with more than three legs.

A four-leg intersection has 75 percent fewer conflicts between vehicles and pedestrians and other vehicles, compared to a conventional four-leg intersection.

See Chapter 5 for a comparison of intersection conflicts.

Exhibit 2-3. Comparisons of vehicle-vehicle conflict points for intersections with four single-lane approaches.

Types of intersection conflicts.

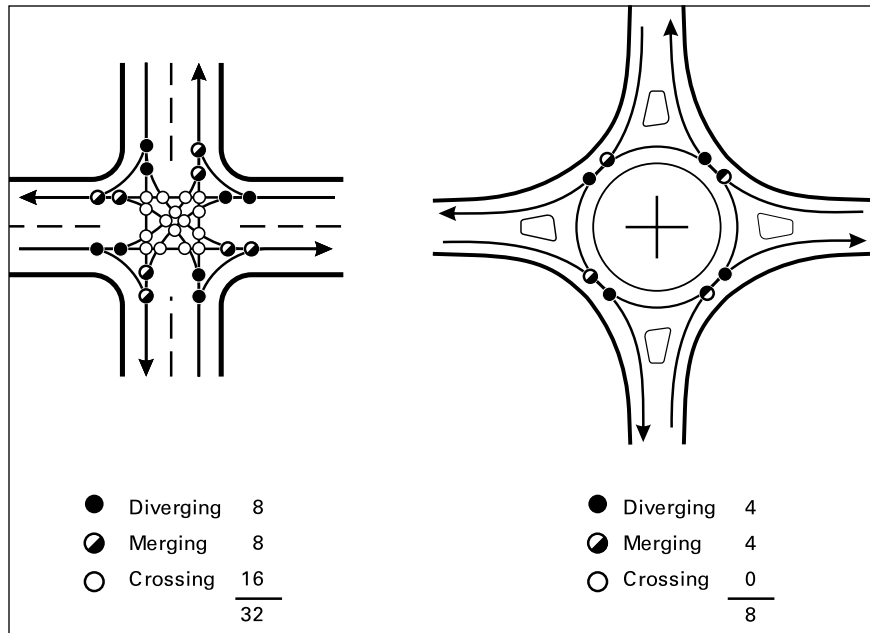

Roundabouts eliminate crossing conflicts by converting all movements to right turns.

As Exhibit 2-3 shows, a roundabout eliminates vehicle-vehicle crossing conflicts by converting all movements to right turns. Separate turn lanes and traffic control (stop signs or signalization) can often reduce but not eliminate the number of crossing conflicts at a traditional intersection by separating conflicts in space and/or time. However, the most severe crashes at signalized intersections occur when there is a violation of the traffic control device designed to separate conflicts by time (e.g., a right-angle collision due to a motorist running a red light, or vehicle-pedestrian collisions). The ability of roundabouts to reduce conflicts through physical, geometric features has been demonstrated to be more effective than the reliance on driver obedience to traffic control devices. At intersections with more than four legs, a roundabout or pair of roundabouts may sometimes be the most practical alternative to minimize the number of conflicts.

Drivers approaching a single-lane roundabout have five basic decisions regarding other users. First, drivers must be mindful of any bicyclists merging into motor vehicle traffic from the right side of the road or a bicycle lane or shoulder. Then they must yield to any pedestrians crossing at the entry. Third, they must choose an acceptable gap in which to enter the roundabout. Then they must choose the correct exit, and finally, they must yield to any pedestrians crossing the exit lane.

By contrast, a driver making a left turn from the minor leg of a two-way stop-controlled intersection has to yield to pedestrians and bicyclists, and judge gaps in both of the major street through movements from both directions, as well as the major street left and right turns and opposing minor through and right turns.

Signalized intersections have simplified the decision-making process for drivers, especially at locations where protected left-turn phasing is provided, by separating conflicts in time and space. However, the rules and driver decisions for negotiating signalized intersections are still quite complex when all the possible signal phasing schemes are accounted for. For signals with permitted left-turn phasing, the driver

must be cognizant of the opposing traffic including pedestrians, and the signal indication (to ensure a legal maneuver). At roundabouts, once at the yield line, the entering driver can focus attention entirely on the circulating traffic stream approaching from the left. A driver behind the entering driver can focus entirely on crossing pedestrians.

2.1.1.2 Double-lane roundabouts

As discussed in Chapter 1, double-lane roundabouts are those with at least one entry that has two lanes. In general, double-lane roundabouts have some of the same safety characteristics for vehicle occupants as their less complicated single-lane counterparts. However, due to the presence of multiple entry lanes and the accompanying need to provide wider circulatory and exit roadways, double-lane roundabouts have complications that result in poorer safety characteristics, particularly for bicyclists and pedestrians, than single-lane roundabouts serving similar traffic demands. This makes it important to use the minimum number of entry, circulating, and exit lanes, subject to capacity considerations.

Due to their typically larger size compared to single-lane roundabouts, double-lane roundabouts often cannot achieve the same levels of speed reduction as their single-lane counterparts. Wider entering, circulating, and exiting roadways enable a vehicle to select a path that crosses multiple lanes, as shown in Exhibit 2-4. Because of the higher-speed geometry, single-vehicle accidents can be more severe. However, design of double-lane roundabouts according to the procedures in Chapter 6, especially the approach and entry, can substantially reduce the speeds of entering vehicles and consequently reduce the severity of conflicts. Even so, speed control cannot occur to the extent possible with single-lane roundabouts.

Pedestrians crossing double-lane roundabouts are exposed for a longer time and to faster vehicles. They can also be obscured from, or not see, approaching vehicles in adjacent lanes if vehicles in the nearest lane yield to them. Children, wheel-

Increasing the number of lanes increases the number of conflict points.

The design of double-lane roundabouts to control the speed of the fastest vehicle path is covered in Chapter 6.

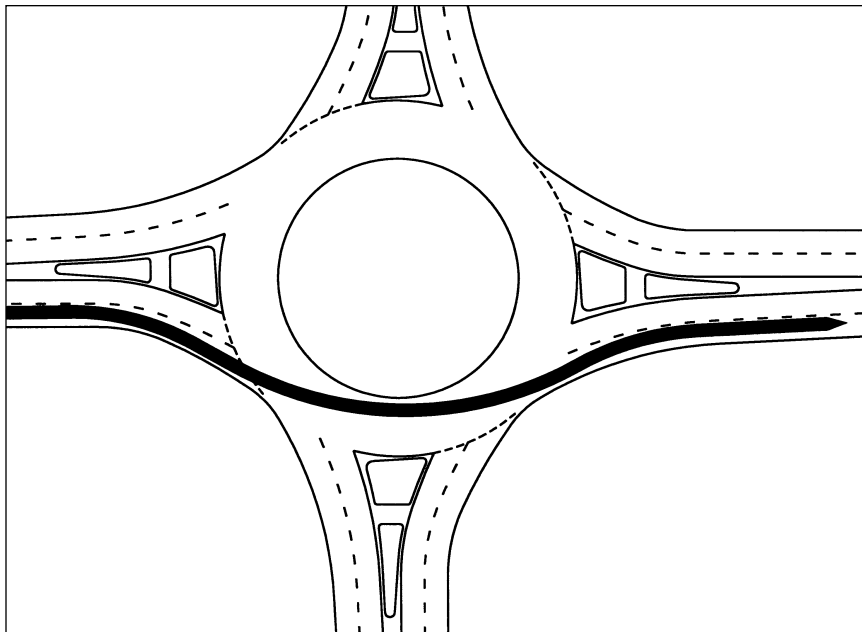

Exhibit 2-4. Fastest vehicle path through a double-lane roundabout.

chair users, and visually impaired pedestrians face particular risks. Bicycles are also more exposed to severe conflicts when choosing to circulate with motor vehicles.

Double-lane roundabouts can be confusing without proper engineering and user education.

Driver decisions are more complex at double-lane roundabouts. The requirement to yield to pedestrians still applies. The primary additional decisions are the choices of the proper lane for entering, lateral position for circulating, and proper lane for exiting the roundabout. Lane choice on approaching a double-lane roundabout is no different from approaching a signalized intersection: to turn left, stay left; to turn right, stay right. However, the decisions for circulating within and especially exiting a double-lane roundabout are unique.

Consider guide signs for roundabouts with skewed approaches or more than four legs.

Double-lane roundabouts with legs aligned at approximately 90-degree angles allow motorists to determine the appropriate lane choice for their path through the roundabout in a relatively easy manner. Double-lane roundabouts with more than four legs and/or with legs aligned at angles significantly different from 90 degrees make driver decisions more complicated. This occurs because it can be difficult on some legs to determine which movements are left, through, and right. For this reason, it is desirable that multilane roundabouts be limited to a maximum of four legs, with legs aligned at approximately 90-degree angles. If this is not possible, special advance guide signs showing appropriate lane choice should be considered.

Sections 2.5 and 2.6 cover user education topics.

When double-lane roundabouts are first introduced to an area, there is a need for adequate user education. Recommendations for user education material specifically related to this issue are presented later in this chapter.

Techniques for estimating delay are given in Chapter 4.

2.1.2 Vehicle delay and queue storage

When operating within their capacity, roundabout intersections typically operate with lower vehicle delays than other intersection forms and control types. With a roundabout, it is unnecessary for traffic to come to a complete stop when no conflicts present themselves, or else deceleration will avoid a conflict. When there are queues on one or more approaches, traffic within the queues usually continues to move, and this is typically more tolerable to drivers than a stopped or standing queue. The performance of roundabouts during off-peak periods is particularly good in contrast to other intersection forms, typically with very low average delays.

Since all intersection movements at a roundabout have equal priority, major street movements may be delayed more than desired.

2.1.3 Delay of major movements

Roundabouts tend to treat all movements at an intersection equally. Each approach is required to yield to circulating traffic, regardless of whether the approach is a local street or major arterial. In other words, all movements are given equal priority. This may result in more delay to the major movements than might otherwise be desired. This problem is most acute at the intersection of high-volume major streets with low- to medium-volume minor streets (e.g., major arterial streets with minor collectors or local streets). Therefore, the overall street classification system and hierarchy should be considered before selecting a roundabout (or stop-controlled) intersection. This limitation should be specifically considered on emergency response routes in comparison with other intersection types and control. The delays depend on the volume of turning movements and should be analyzed individually for each approach, according to the procedures in Chapter 4.

2.1.4 Signal progression

It is common practice to coordinate traffic signals on arterial roads to minimize stops and delay to through traffic on the major road. By requiring coordinated platoons to yield to traffic in the circulatory roadway, the introduction of a roundabout into a coordinated signal system may disperse and rearrange platoons of traffic if other conflicting flows are significant, thereby reducing progressive movement. To minimize overall system delay, it may be beneficial to divide the signal system into subsystems separated by the roundabout, assigning each subsystem its own cycle. The traffic performance of the combination roundabout-signal system should be tested in advance with signal systems and roundabout analysis tools. In some cases, total delay, stops, and queues will be reduced by the roundabout. The number of available gaps for midblock unsignalized intersections and driveways may also be reduced by the introduction of roundabouts, although this may be offset by the reduced speeds near roundabouts. In addition, roundabouts can enable safe and quick U-turns that can substitute for more difficult midblock left turns, especially where there is no left turn lane.

2.1.5 Environmental factors

Roundabouts may provide environmental benefits if they reduce vehicle delay and the number and duration of stops compared with an alternative. Even when there are heavy volumes, vehicles continue to advance slowly in moving queues rather than coming to a complete stop. This may reduce noise and air quality impacts and fuel consumption significantly by reducing the number of acceleration/deceleration cycles and the time spent idling.

In general, if stop or yield control is insufficient, traffic through roundabouts generates less pollution and consumes less fuel than traffic at fixed-time signalized intersections. However, vehicle-actuated signals typically cause less delay, less fuel consumption, and less emissions than roundabouts as long as traffic volumes are low. During busy hours, vehicle-actuated signals tend to operate like fixed-time signals, and the percentage of cars that must stop becomes high (5).

2.1.6 Spatial requirements

Roundabouts usually require more space for the circular roadway and central island than the rectangular space inside traditional intersections. Therefore, roundabouts often have a significant right-of-way impact on the corner properties at the intersection, especially when compared with other forms of unsignalized intersection. The dimensions of a traditional intersection are typically comparable to the envelope formed by the approaching roadways. However, to the extent that a comparable roundabout would outperform a signal in terms of reduced delay and thus shorter queues, it will require less queue storage space on the approach legs. If a signalized intersection requires long or multiple turn lanes to provide sufficient capacity or storage, a roundabout with similar capacity may require less space on the approaches. As a result, roundabouts may reduce the need for additional right-of-way on the links between intersections, at the expense of additional right-of-way requirements at the intersections themselves (refer to Chapters 3 and 8). The right-of-way savings between intersections may make it feasible to accommodate parking, wider sidewalks, planter strips, wider outside lanes, and/or bicycle lanes in order to better accommodate pedestrians and/or bicyclists. Another space-saving strategy is the use of flared approach lanes to provide additional capacity at the

intersection while maintaining the benefit of reduced spatial requirements upstream and downstream of an intersection.

At interchange ramp terminals, paired roundabouts have been used to reduce the number of lanes in freeway over- and underpasses. In compact urban areas, there are typically signalized intersections at both ends of overpass bridges, necessitating two additional overpass lanes to provide capacity and storage at the signalized intersections.

2.1.7 Operation and maintenance costs

Compared to signalized intersections, a roundabout does not have signal equipment that requires constant power, periodic light bulb and detection maintenance, and regular signal timing updates. Roundabouts, however, can have higher landscape maintenance costs, depending on the degree of landscaping provided on the central island, splitter islands, and perimeter. Illumination costs for roundabouts and signalized intersections are similar. Drivers sometimes face a confusing situation when they approach a signalized intersection during a power failure, but such failures have minimal temporary effect on roundabouts or any other unsignalized intersections, other than the possible loss of illumination. The service life of a roundabout is significantly longer, approximately 25 years, compared with 10 years for a typical signal (6).

2.1.8 Traffic calming

Series of roundabouts can have secondary, traffic calming effects on streets by reducing vehicle speeds. As discussed previously, speed reduction at roundabouts is caused by geometry rather than by traffic control devices or traffic volume. Consequently, speed reduction can be realized at all times of day and on streets of any traffic volume. It is difficult to speed through an appropriately designed roundabout with raised channelization that forces vehicles to physically change direction. In this way, roundabouts can complement other traffic calming measures.

By reducing speeds, roundabouts complement other traffic calming measures.

Roundabouts have also been used successfully at the interface between rural and urban areas where speed limits change. In these applications, the traffic calming effects of roundabouts force drivers to slow and reinforce the notion of a significant change in the driving environment.

2.1.9 Aesthetics

Landscaping issues are discussed in detail in Chapter 7.

Roundabouts offer the opportunity to provide attractive entries or centerpieces to communities. However, hard objects in the central island directly facing the entries are a safety hazard. The portions of the central island and, to a lesser degree, the splitter islands that are not subject to sight-distance requirements offer opportunities for aesthetic landscaping. Pavement textures can be varied on the aprons as well. Exhibit 2-5 presents examples of the aesthetic treatments that have been applied to roundabouts. They can also be used in tourist or shopping areas to facilitate safe U-turns and to demarcate commercial uses from residential areas. They have been justified as a spur to economic development, conveying to developers that the area is favorable for investment in redevelopment. Some are exhibited as a "signature" feature on community postcards, advertisements, and travelogues.



(a) West Boca Raton, FL



(b) Santa Barbara, CA

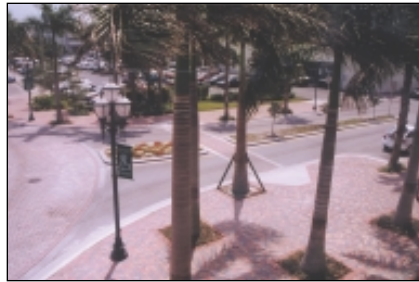

(c) Fort Pierce, FL



(d) Vail, CO

Exhibit 2-5. Examples of aesthetic treatments.

2.1.10 Design for older drivers

In the United States, there is a trend toward an aging population, as well as individuals, continuing to drive until an older age. This trend has implications for all roadway design, including roundabout design, ranging from operations through geometric and sign design. In this regard, designers should consult available documents such as the Federal Highway Administration (FHWA) *Older Driver Highway Design Handbook* (7):

- The single greatest concern in accommodating older road users, both drivers and pedestrians, is the ability of these persons to safely maneuver through intersections.
- Driving situations involving complex speed-distance judgments under time constraints are more problematic for older drivers and pedestrians than for their younger counterparts.
- Older drivers are much more likely to be involved in crashes where the drivers were driving too fast for the curve or, more significantly, were surprised by the curved alignment.
- Many studies have shown that loss-of-control crashes result from an inability to maintain lateral position through the curve because of excessive speed, with inadequate deceleration in the approach zone. These problems in turn stem from a combination of factors, including poor anticipation of vehicle control requirements, induced by the driver's prior speed, and inadequate perception of the demands of the curve.
- Older drivers have difficulties in allocating attention to the most relevant aspects of novel driving situations.
- Older drivers generally need more time than average drivers to react to events.

While the *Handbook* is not specific to roundabouts, and since no age-related research has been conducted with U.S. roundabouts to date, these findings may apply to older persons encountering roundabouts, as well. The excerpts above all imply that lower, more conservative design speeds are appropriate. Roundabouts designed for low, consistent speeds cater to the preferences of older drivers: slower speeds; time to make decisions, act, and react; uncomplicated situations to interpret; simple decision-making; a reduced need to look over one's shoulder; a reduced need to judge closing speeds of fast traffic accurately; and a reduced need to judge gaps in fast traffic accurately. For example, two-way stop-controlled intersections may be appropriate for replacement with a roundabout when a crash analysis indicates that age-related collisions are prevalent.

2.2 Multimodal Considerations

As with any intersection design, each transportation mode present requires careful consideration. This section presents some of the general issues associated with each mode; additional detail on mode-specific safety and design issues is provided in subsequent chapters.

2.2.1 Pedestrians

Pedestrian crossings should be set back from the yield line by one or more vehicle lengths.

Pedestrians are accommodated by crossings around the perimeter of the roundabout. By providing space to pause on the splitter island, pedestrians can consider one direction of conflicting traffic at a time, which simplifies the task of crossing the street. The roundabout should be designed to discourage pedestrians from crossing to the central island, e.g., with landscape buffers on the corners. Pedestrian crossings are set back from the yield line by one or more vehicle lengths to:

- Shorten the crossing distance compared to locations adjacent to the inscribed circle;
- Separate vehicle-vehicle and vehicle-pedestrian conflict points; and
- Allow the second entering driver to devote full attention to crossing pedestrians while waiting for the driver ahead to enter the circulatory roadway.

If sidewalks on the intersecting roads are adjacent to the curbs, this setback may require the sidewalks to deviate from a straight path. This is not the case if sidewalks are separated from the curbs by a generous landscape buffer.

Most intersections are two-way stop-controlled, or uncontrolled. Compared to two-way stop-controlled intersections, roundabouts may make it easier and safer for pedestrians to cross the major street. At both roundabouts and two-way stop-controlled intersections, pedestrians have to judge gaps in the major (uncontrolled) stream of traffic. By reducing stopping distance, the low vehicular speeds through a roundabout generally reduce the frequency and severity of incidents involving pedestrians. In addition, when crossing an exit lane on the minor road, the sight angle is smaller than when watching for left-turning vehicles at a conventional intersection.

The comparison between roundabouts and all-way stop-controlled intersections is less clear. All-way stop control is virtually nonexistent in foreign countries that have

roundabouts, and so there is little international experience with which to compare. All-way stop-controlled intersections may be preferred by pedestrians with visual impairment because vehicles are required to stop before they enter the intersection. However, crossing the exit leg of an all-way stop-controlled intersection can be intimidating for a pedestrian since traffic may be turning onto the exit from multiple directions. Roundabouts, on the other hand, allow pedestrians to cross one direction of traffic at a time; however, traffic may be moving (albeit at a slow speed), thus making it more challenging to judge gaps, especially for visually impaired users, children, and the elderly.

The biggest difference may be that all-way stop-controlled intersections, like two-way stops, do not provide positive geometric features to slow vehicles and instead rely entirely on the authority of the traffic control device. The roundabout geometry physically slows and deflects vehicles, reducing the likelihood of a high-speed collision due to a traffic control device violation.

Signalized intersections offer positive guidance to pedestrians by providing visual and occasionally audible pedestrian signal indications. In this respect, the decision process for pedestrians requires less judgment at signalized intersections than at roundabouts, particularly for visually impaired and elderly pedestrians. However, pedestrians are still vulnerable at signalized intersections to right-turn and left-turn movements unprotected by a green arrow. In addition, high-speed collisions are still possible if a vehicle runs through a red indication. In this respect, the roundabout provides a speed-constrained environment for through traffic. At two-way and all-way stop intersections, right-turning motorists often look only to the left in order to check for vehicular conflicts, endangering or inconveniencing pedestrians crossing from the right or on the right. This situation is exacerbated by the fact that many of these drivers do not come to a complete stop if they do not perceive any conflicts. With crosswalks located back from the circulatory roadway, roundabouts place pedestrians in a more visible location.

The two populations at opposite ends of the age continuum—children and the elderly—and people with disabilities are particularly at risk at intersections. Children (owing to their lack of traffic experience, impulsiveness, and small size) and the elderly (owing to their age-related physical limitations) present challenges to the designer. In recognition of pedestrians with disabilities, intersections must comply with Americans with Disabilities Act (ADA) mandated accessibility standards discussed in Section 2.4.5 and Chapter 5.

Elderly pedestrians, children, and the disabled find it more difficult to cross unprotected road crossings. These types of pedestrians generally prefer larger gaps in the traffic stream, and walk at slower speeds than other pedestrians. Multilane roadways entering and exiting double-lane roundabouts require additional skills to cross, since pedestrians need assurance that they have been seen by drivers in each lane they are crossing.

When crossing a roundabout, there are several areas of difficulty for the blind and or visually impaired pedestrian. It is expected that a visually impaired pedestrian with good travel skills must be able to arrive at an unfamiliar intersection and cross it with pre-existing skills and without special, intersection-specific training. Roundabouts pose problems at several points of the crossing experience, from the perspective of information access.

When crossing a roundabout, there are several areas of difficulty for the blind and or visually impaired pedestrian.

Unless these issues are addressed by a design, the intersection is “inaccessible” and may not be permissible under the ADA. Chapters 5, 6, and 7 provide specific suggestions to assist in providing the above information. However, more research is required to develop the information jurisdictions need to determine where roundabouts may be appropriate and what design features may be appropriate for the disabled, such as audible signalized crossings. Until specific standards are adopted, engineers and jurisdictions must rely on existing related research and professional judgment to design pedestrian features so that they are usable by pedestrians with disabilities.

2.2.2 Bicycles

Roundabouts may not provide safety benefits to bicyclists (1). Nevertheless, the recommended roundabout designs discourage erratic or undesirable driver behavior. They slow drivers to speeds more compatible with bicycle speeds, while reducing high-speed conflicts and simplifying turn movements for bicyclists. Typical commuter bicyclist speeds are around 25 km/h (15 mph), so entering a roundabout designed for circulating traffic to flow at similar speeds should be safer compared with larger and faster roundabout designs. Bicyclists require particular attention in two-lane roundabout design, especially in areas with moderate to heavy bicycle traffic.

As with pedestrians, one of the difficulties in accommodating bicyclists is their wide range of skills and comfort levels in mixed traffic. On single-lane roundabouts, bicyclists have the option of either mixing with traffic or using the roundabout like a pedestrian. The former option will likely be reasonably comfortable for experienced cyclists; however, less-experienced cyclists (including children) may have difficulty and discomfort mixing with vehicles and are more safely accommodated as pedestrians.

Bike lanes through roundabouts should never be used.

The complexity of vehicle interactions within a roundabout leaves a cyclist vulnerable, and for this reason, bike lanes within the circulatory roadway should never be used. On double-lane roundabouts, a bicycle path separate and distinct from the circulatory roadway is preferable, such as a shared bicycle-pedestrian path of sufficient width and appropriately marked to accommodate both types of users around the perimeter of the roundabout. While this will likely be more comfortable for the casual cyclist, the experienced commuter cyclist will be significantly slowed down by having to cross as a pedestrian at each approach crossing and may choose to continue to traverse a double-lane roundabout as a vehicle. It may sometimes be possible to provide cyclists with an alternative route along another street or path that avoids the roundabout, which should be considered as part of overall network planning. The provision of alternative routes should not be used to justify compromising the safety of bicycle traffic through the roundabout because experienced cyclists and those with immediately adjacent destinations will use it.

2.2.3 Large vehicles

Design roundabouts to accommodate the largest vehicle that can reasonably be expected.

Roundabouts should always be designed for the largest vehicle that can be reasonably anticipated (the “design vehicle”). For single-lane roundabouts, this may require the use of a mountable apron around the perimeter of the central island to provide the additional width needed for tracking the trailer wheels. At double-lane roundabouts, large vehicles may track across the whole width of the circulatory roadway to negotiate the roundabout. In some cases, roundabouts have been

designed with aprons or gated roadways through the central island to accommodate oversized trucks, emergency vehicles, or trains.

2.2.4 Transit

Transit considerations at a roundabout are similar to those at a conventional intersection. If the roundabout has been designed using the appropriate design vehicle, a bus should have no physical difficulty negotiating the intersection. To minimize passenger discomfort, if the roundabout is on a bus route, it is preferable that scheduled buses are not required to use a truck apron if present. Bus stops should be located carefully to minimize the probability of vehicle queues spilling back into the circulatory roadway. This typically means that bus stops located on the far side of the intersection need to have pullouts or be further downstream than the splitter island. Pedestrian access routes to transit should be designed for safety, comfort, and convenience. If demand is significant, such as near a station or terminus, pedestrian crossing capacity should be accounted for.

Roundabouts may provide opportunities for giving transit (including rail) and emergency vehicles priority as can be done at signalized intersections. This may be provided using geometry, or signals. For example, these could include an exclusive right-turn bypass lane or signals holding entering traffic while the transit vehicle enters its own right-of-way or mixed traffic. The roundabout can be supplemented by signals activated by a transit, emergency, or rail vehicle. Chapters 6, 7, and 8 provide more detail on transit treatments.

2.2.5 Emergency vehicles

The passage of large emergency vehicles through a roundabout is the same as for other large vehicles and may require use of a mountable apron. On emergency response routes, the delay for the relevant movements at a planned roundabout should be compared with alternative intersection types and control. Just as they are required to do at conventional intersections, drivers should be educated not to enter a roundabout when an emergency vehicle is approaching on another leg. Once having entered, they should clear out of the circulatory roadway if possible, facilitating queue clearance in front of the emergency vehicle.

Roundabouts provide emergency vehicles the benefit of lower vehicle speeds, which may make roundabouts safer for them to negotiate than signalized crossings. Unlike at signalized intersections, emergency vehicle drivers are not faced with through vehicles unexpectedly running the intersection and hitting them at high speed.

2.2.6 Rail crossings

Rail crossings through or near a roundabout may involve many of the same design challenges as at other intersections and should be avoided if better alternatives exist. In retrofit, the rail track may be designed to pass through the central island, or across one of the legs. Queues spilling back from a rail blockage into the roundabout can fill the circulatory roadway and temporarily prevent movement on any approach. However, to the extent that a roundabout approach capacity exceeds that of a signal at the same location, queues will dissipate faster. Therefore, a case-specific capacity and safety analysis is recommended. Section 8.2 addresses the design of at-grade rail crossings.

Public transit buses should not be forced to use a truck apron to negotiate a roundabout.

Chapters 6-8 provide more detail on transit treatments.

See Section 8.2 for information on designing roundabouts located near at-grade rail crossings.

2.3 Costs Associated with Roundabouts

Many factors influence the amount of economic investment justified for any type of intersection. Costs associated with roundabouts include construction costs, engineering and design fees, land acquisition, and maintenance costs. Benefits may include reduced crash rates and severity, reduced delay, stops, fuel consumption, and emissions. Benefit-cost analysis is discussed further in Chapter 3.

When comparing costs, it is often difficult to separate the actual intersection costs from an overall improvement project. Accordingly, the reported costs of installing roundabouts have been shown to vary significantly from site to site. A roundabout may cost more or less than a traffic signal, depending on the amount of new pavement area and the extent of other roadway work required. At some existing unsignalized intersections, a traffic signal can be installed without significant modifications to the pavement area or curbs. In these instances, a roundabout is likely to be more costly to install than a traffic signal, as the roundabout can rarely be constructed without significant pavement and curb modifications.

Roundabouts may require more pavement area at the intersection, compared to a traffic signal, but less on the approaches and exits.

However, at new sites, and at signalized intersections that require widening at one or more approaches to provide additional turn lanes, a roundabout can be a comparable or less expensive alternative. While roundabouts typically require more pavement area at the intersection, they may require less pavement width on the upstream approaches and downstream exits if multiple turn lanes associated with a signalized intersection can be avoided. The cost savings of reduced approach roadway widths is particularly advantageous at interchange ramp terminals and other intersections adjacent to grade separations where wider roads may result in larger bridge structures. In most cases, except potentially for a mini-roundabout, a roundabout is more expensive to construct than the two-way or all-way stop-controlled intersection alternatives.

Recent roundabout projects in the United States have shown a wide range in reported construction costs. Assuming “1998 U.S. Dollars” in the following examples, costs ranged from \$10,000 for a retrofit application of an existing traffic circle to \$500,000 for a new roundabout at the junction of two State highways. National Cooperative Highway Research Program (NCHRP) Synthesis 264 (3) reports that the average construction cost of 14 U.S. roundabouts, none being part of an interchange, was approximately \$250,000. This amount includes all construction elements, but does not include land acquisition.

The cost of maintaining traffic during construction of a roundabout retrofit can be relatively high.

Higher costs are typically incurred when a substantial amount of realignment, grading, or drainage work is required. The cost of maintaining traffic during construction tends to be relatively high for retrofitting roundabouts. This expense is due mainly to the measures required to maintain existing traffic flow through the intersection while rebuilding it in stages. Other factors contributing to high roundabout costs are large amounts of landscaping in the central and splitter islands, extensive signing and lighting, and the provision of curbs on all outside pavement edges.

Operating and maintenance costs of roundabouts are somewhat higher than for other unsignalized intersections, but less than those for signalized intersections. In addition, traffic signals consume electricity and require periodic service (e.g., bulb replacement, detector replacement, and periodic signal retiming). Operating costs for a roundabout are generally limited to the cost of illumination (similar to signalized alternatives, but typically more than is required for other unsignalized intersections).

Maintenance includes regular restriping and repaving as necessary, as well as snow removal and storage in cold climates (these costs are also incurred by conventional intersections). Landscaping may require regular maintenance as well, including such things as pruning, mowing, and irrigation system maintenance. To the extent that roundabouts reduce crashes compared with conventional intersections, they will reduce the number and severity of incidents that disrupt traffic flow and that may require emergency service.

2.4 Legal Considerations

The legal environment in which roundabouts operate is an important area for jurisdictions to consider when developing a roundabout program or set of guidelines. The rules of the road that govern the operation of motor vehicles in a given State can have a significant influence on the way a roundabout operates and on how legal issues such as crashes involving roundabouts are handled. Local jurisdictions that are interested in developing a roundabout program need to be aware of the governing State regulations in effect. The following sections discuss several of the important legal issues that should be considered. These have been based on the provisions of the 1992 Uniform Vehicle Code (UVC) (8), which has been adopted to varying degrees by each State, as well as the rules of the road, and commentaries thereof, from the United Kingdom (9) and Australia (10, 11). Note that the information in the following sections does not constitute specific legal opinion; each jurisdiction should consult with its attorneys on specific legal issues.

2.4.1 Definition of “intersection”

The central legal issue around which all other issues are derived is the fundamental relationship between a roundabout and the legal definition of an “intersection.” A roundabout could be legally defined one of two ways:

- As a single intersection; or
- As a series of T-intersections.

The UVC does not provide clear guidance on the appropriate definition of an intersection with respect to roundabouts. The UVC generally defines an “intersection” as the area bounded by the projection of the boundary lines of the approaching roadways (UVC §1-132a). It also specifies that where a highway includes two roadways 9.1 m (30 ft) or more apart, each crossing shall be regarded as a separate intersection (UVC §1-132b). This may imply that most circular intersections should be regarded as a series of T-intersections. This distinction has ramifications in the interpretation of the other elements identified in this section.

This guide recommends that a roundabout be specifically defined as a single intersection, regardless of the size of the roundabout. This intersection should be defined as the area bounded by the limits of the pedestrian crossing areas around the perimeter of a single central island. Closely spaced roundabouts with multiple central islands should be defined as separate intersections, as each roundabout is typically designed to operate independently.

It is recommended that roundabouts be defined as a single intersection: the area bounded by the limits of the pedestrian crossing areas.

Because of yield-to-the-right laws, yield signs and lines must be used on roundabout entries to assign right-of-way to the circulatory roadway.

2.4.2 Right-of-way between vehicles

The UVC specifies that “when two vehicles approach or enter an intersection from different highways at approximately the same time, the driver of the vehicle on the left shall yield the right-of-way to the vehicle on the right” (UVC §11-401). This runs contrary to the default operation of a roundabout, which assigns the right-of-way to the vehicle on the left and any vehicle in front. This requires the use of yield signs and yield lines at all approaches to a roundabout to clearly define right-of-way.

This guide recommends that right-of-way at a roundabout be legally defined such that an entering vehicle shall yield the right-of-way to the vehicle on the left (France passed such a law in 1984). This definition does not change the recommendation for appropriately placed yield signs and yield lines.

2.4.3 Required lane position at intersections

At a typical intersection with multilane approaches, vehicles are required by the UVC to use the right-most lane to turn right and the left-most lane to turn left, unless specifically signed or marked lanes allow otherwise (e.g., double left-turn lanes) (UVC §11-601). Because multilane roundabouts can be used at intersections with more than four legs, the concept of “left turns” and “right turns” becomes more difficult to legally define. The following language (10) is recommended:

**Recommended lane assignments:
Exit less than halfway, use the right lane. Exit more than halfway, use the left lane. Exit exactly halfway, use either lane.**

Unless official traffic control devices indicate otherwise, drivers must make lane choices according to the following rules:

- *If a driver intends to exit the roundabout less than halfway around it, the right lane must be used.*
- *If a driver intends to exit the roundabout more than halfway around it, the left lane must be used.*

The Australian Traffic Act (10) gives no guidance for straight through movements (movements leaving the roundabout exactly halfway), and the general Australian practice is to allow drivers to use either lane unless signed or marked otherwise. On multilane roundabouts where the intersecting roadways are not at 90-degree angles or there are more than four legs to the roundabout, special consideration should be given to assisting driver understanding through advance diagrammatic guide signs or lane markings on approaches showing the appropriate lane choices.

2.4.4 Priority within the circulatory roadway

For multilane roundabouts, the issue of priority within the circulatory roadway is important. Any vehicle on the inner track on the circulatory roadway (e.g., a vehicle making a left turn) will ultimately cross the outer track of the circulatory roadway to exit. This may cause conflicts with other vehicles in the circulatory roadway.

Consistent with its lack of treatment of roundabouts, the UVC does not provide clear guidance on priority within the circulatory roadway of a roundabout. In general, the UVC provides that all overtaking should take place on the left (UVC §11-303). However, the UVC also specifies the following with respect to passing on the right (UVC §11-304a):

The driver of a vehicle may overtake and pass upon the right of another vehicle only under the following conditions.

- 1. When the vehicle overtaken is making or about to make a left turn;*
- 2. Upon a roadway with unobstructed pavement of sufficient width for two or more lines of vehicles moving lawfully in the direction being traveled by the overtaking vehicle.*

A case could be made that this provision applies to conditions within a circulatory roadway of a multilane roundabout. Under the definition of a roundabout as a single intersection, a vehicle making a left turn could be overtaken on the right, even though the completion of the left turn requires exiting on the right.

International rules of the road vary considerably on this point. The United Kingdom, for example, requires drivers to “watch out for traffic crossing in front of you on the roundabout, especially vehicles intending to leave by the next exit. Show them consideration.” (9, §125) This is generally interpreted as meaning that a vehicle at the front of a bunch of vehicles within the circulatory roadway has the right-of-way, regardless of the track it is on, and following vehicles on any track must yield to the front vehicle as it exits. Australia, on the other hand, does not have a similar statement in its legal codes, and this was one of the factors that led Australians to favor striping of the circulatory roadway in recent years. Further research and legal exploration need to be performed to determine the effect of this legal interpretation on driver behavior and the safety and operation of multilane roundabouts.

For clarity, this guide makes the following recommendations:

- Overtaking within the circulatory roadway should be prohibited.
- Exiting vehicles should be given priority over circulating vehicles, provided that the exiting vehicle is in front of the circulating vehicle.

Recommendations: No overtaking within the circulatory roadway, and exiting vehicles in front of other circulating vehicles have priority when exiting.

2.4.5 Pedestrian accessibility

The legal definition of a roundabout as one intersection or a series of intersections also has implications for pedestrians, particularly with respect to marked and unmarked crosswalks. A portion of the UVC definition of a crosswalk is as follows: “. . . and in the absence of a sidewalk on one side of the roadway, that part of a roadway included within the extension of the lateral lines of the existing sidewalk at right angles to the centerline” (UVC §1-112(a)). Under the definition of a roundabout as a series of T-intersections, this portion of the definition could be interpreted to mean that there are unmarked crosswalks between the perimeter and the central island at every approach. The recommended definition of a roundabout as a single intersection simplifies this issue, for the marked or unmarked crosswalks around the perimeter as defined are sufficient and complete.

In all States, drivers are required to either yield or stop for pedestrians in a crosswalk (however, this requirement is often violated, and therefore it is prudent for pedestrians not to assume that this is the case). In addition, the provisions of the ADA also apply to roundabouts in all respects, including the design of sidewalks, crosswalks, and ramps. Under the ADA, accessible information is required to make the existing public right-of-way an accessible program provided by State and local governments (28 CFR 35.150). Any facility or part of a facility that is newly constructed by a State or local government must be designed and constructed so that

it is readily accessible to and usable by people with disabilities (28 CFR 35.151(a)). Alterations to existing facilities must include modifications to make altered areas accessible to individuals with disabilities (28 CFR 735.151 (b)).

Current guidelines do not specifically address ways to make roundabouts accessible. Nonetheless, these provisions mean providing information about safely crossing streets in an accessible format, including at roundabouts. At a minimum, design information should provide for:

- Locating the crosswalk;
- Determining the direction of the crosswalk;
- Determining a safe crossing time; and
- Locating the splitter island refuge.

2.4.6 Parking

Many States prohibit parking within a specified distance of an intersection; others allow parking right up to the crosswalk. The degree to which these laws are in place will govern the need to provide supplemental signs and/or curb markings showing parking restrictions. To provide the necessary sight distances for safe crossings to occur, this guide recommends that parking be restricted immediately upstream of the pedestrian crosswalks.

The legal need to mark parking restrictions within the circulatory roadway may be dependent on the definition of a roundabout as a single intersection or as a series of T-intersections. Using the recommended definition of a roundabout as a single intersection, the circulatory roadway would be completely contained within the intersection, and the UVC currently prohibits parking within an intersection (UVC §11-1003).

2.5 Public Involvement

Public acceptance of roundabouts has often been found to be one of the biggest challenges facing a jurisdiction that is planning to install its first roundabout. Without the benefit of explanation or first-hand experience and observation, the public is likely to incorrectly associate roundabouts with older, nonconforming traffic circles that they have either experienced or heard about. Equally likely, without adequate education, the public (and agencies alike) will often have a natural hesitation or resistance against changes in their driving behavior and driving environment.

In such a situation, a proposal to install a roundabout may initially experience a negative public reaction. However, the history of the first few roundabouts installed in the United States also indicates that public attitude toward roundabouts improves significantly after construction. A recent survey conducted of jurisdictions across the United States (3) reported a significant negative public attitude toward roundabouts prior to construction (68 percent of the responses were negative or very negative), but a positive attitude after construction (73 percent of the responses were positive or very positive).

A recent survey found negative public attitudes towards roundabouts before construction, but positive attitudes following construction.

A wide variety of techniques have been used successfully in the United States to inform and educate the public about new roundabouts. Some of these include public meetings, informational brochures and videos, and announcements in the newspaper or on television and radio. A public involvement process should be initiated as soon as practical, preferably early in the planning stages of a project while other intersection forms are also being considered.

Public meetings, videos and brochures, and media announcements are some of the ways to educate the public about new roundabouts.

2.5.1 Public meetings

Public meetings can be a good forum for bringing the public into the design process. This allows early identification of potential problems and helps to gain overall acceptance throughout the process. Public input may be useful at various stages in the planning process: data collection, problem definition, generation of design alternatives, selection of preferred alternatives, detailed design, go/no-go decision, construction/opening, and landscape maintenance. Many jurisdictions require or recommend public meetings with the affected neighborhood or businesses prior to approval of the project by elected officials. Even if such meetings are not required, they can be helpful in easing concerns about a new form of intersection for a community.

2.5.2 Informational brochures

A number of agencies, including the Maryland State Highway Administration and the City of Montpelier, Vermont, have used informational brochures to educate the public about roundabouts in their communities. Brochures have also been prepared for specific projects. Exhibit 2-6 shows examples from the brochures prepared for the I-70/Vail Road roundabouts in Vail, Colorado, and the Towson Roundabout in Towson, Maryland. These brochures include drawings or photographic simulations of the proposed roundabout. The brochures also typically include general information on roundabouts (what roundabouts are, where they can be found, and the types of benefits that can be expected). Sometimes they also include instructions on how to use the roundabout as a motorist, bicyclist, and pedestrian. The Towson brochure included additional information on the business association in the area, the streetscape policy of the county, and information on the construction phases of the roundabout.

Exhibit 2-6. Examples of informational brochures.

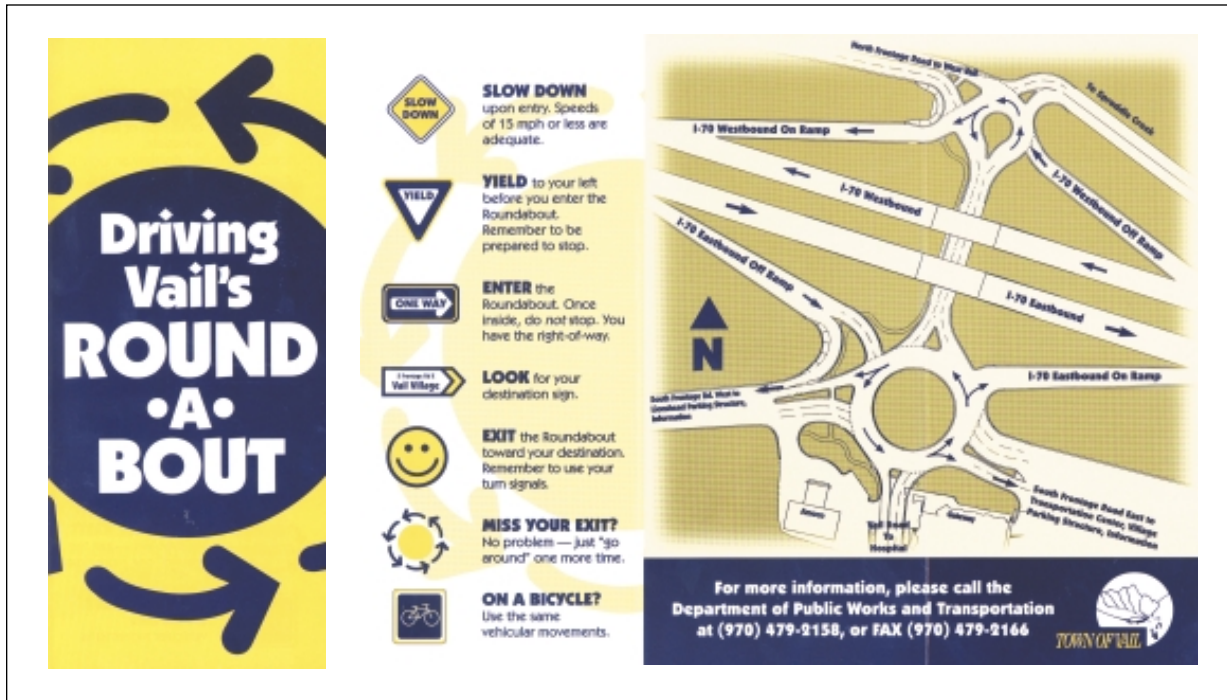

(a) Vail, CO

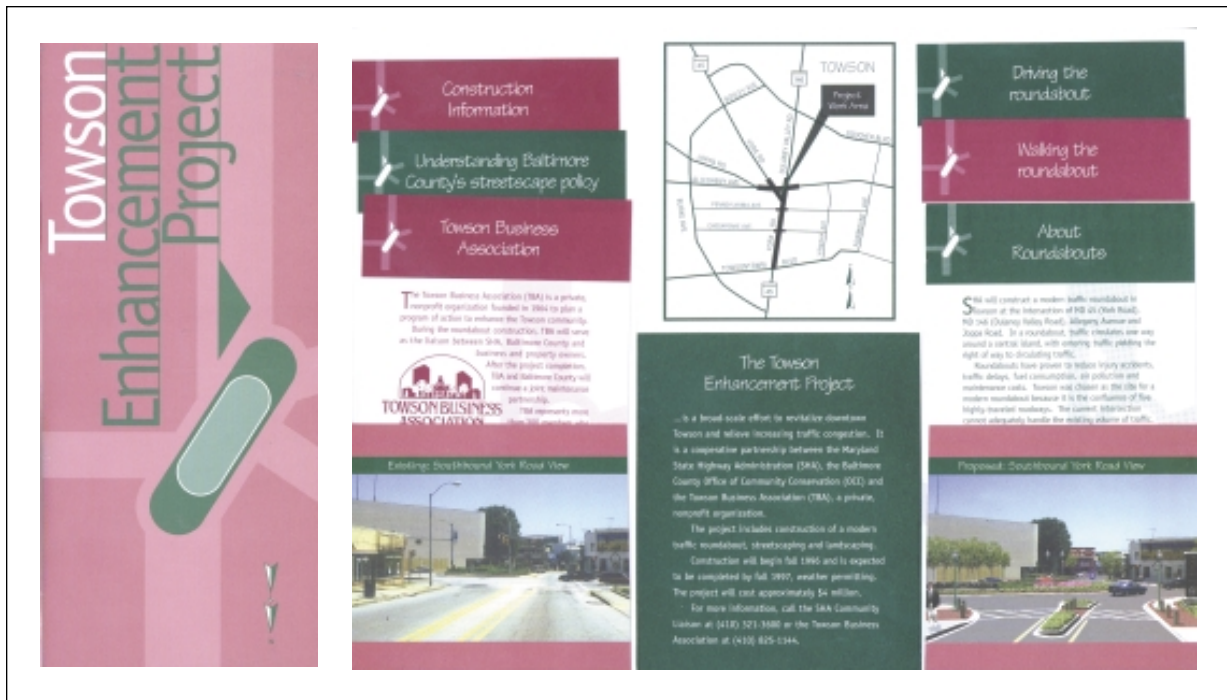

(b) Towson, MD

2.5.3 Informational videos

A number of agencies and consulting firms have prepared videos to inform the public about roundabouts. These videos are typically 10 to 15 minutes in length and include footage of existing roundabouts and narration about their operational and safety characteristics. These videos have been successfully used at public meetings as an effective means of introducing the public to roundabouts.

2.5.4 Media announcements

Given the new nature of a roundabout in many communities, the local media (newspaper, radio, and television) is likely to become involved. Such interest often occurs early in the process, and then again upon the opening of the roundabout. Radio reading services, telephone information services, and publications intended primarily for individuals with disabilities should be used to communicate with persons who are visually impaired when a roundabout is proposed and when it opens.

2.6 Education

One of the important issues facing a State considering the implementation of roundabouts is the need to provide adequate driver, cyclist, and pedestrian education. To clarify the following tips and instructions, user education should begin by using simple exhibits such as those in Chapter 1 to familiarize them with the basic physical features of a roundabout intersection. Users should also familiarize themselves with the instructions for all other modes so that they understand the expectations of each other. The following sections provide instructional material and model language for drivers, cyclists, and pedestrians that can be adapted to drivers manuals. These have been adapted from similar rules of the road and drivers manuals used for roundabouts in the United Kingdom (9), Australia (10), and the State of Victoria, Australia (11).

The following sample instructions assume that readers have already seen introductory material on roundabouts, such as the brochures depicted in the previous section.

2.6.1 Driver education

2.6.1.1 Approaching the roundabout

On approaching a roundabout, decide as early as possible which exit you need to take and get into the correct lane (refer to the section below on “Turning at roundabouts”). Reduce your speed. Bicyclists are vehicles and need to share the lane at intersections. Therefore, allow bicycles to enter the roadway from any bicycle lane. The law gives pedestrians the right-of-way in a crosswalk. Yield to pedestrians waiting to cross or crossing on the approach. Watch out for and be particularly considerate of people with disabilities, children, and elderly pedestrians. Always keep to the right of the splitter island (either painted or raised) on the approach to the roundabout.

2.6.1.2 Entering the roundabout

Upon reaching the roundabout yield line, yield to traffic circulating from the left unless signs or pavement markings indicate otherwise. Do not enter the roundabout beside a vehicle already circulating within the roundabout, as a vehicle near the central island may be exiting at the next exit. Watch out for traffic already on the roundabout, especially cyclists and motorcyclists. Do not enter a roundabout when an emergency vehicle is approaching on another leg; allow queues to clear in front of the emergency vehicle.

2.6.1.3 Within the roundabout

Within a roundabout, do not stop except to avoid a collision; you have the right-of-way over entering traffic. Always keep to the right of the central island and travel in a counterclockwise direction.

Where the circulatory roadway is wide enough to allow two or more vehicles to travel side-by-side, **do not overtake adjacent vehicles who are slightly ahead of yours as they may wish to exit next.** Watch out for traffic crossing in front of you on the roundabout, especially vehicles intending to leave by the next exit. Do not change lanes within the roundabout except to exit.

When an emergency vehicle is approaching, in order to provide it a clear path to turn through the roundabout, proceed past the splitter island of your exit before pulling over.

2.6.1.4 Exiting the roundabout

Maintain a slow speed upon exiting the roundabout. Always indicate your exit using your right-turn signal. For multilane roundabouts, watch for vehicles to your right, including bicycles that may cross your path while exiting, and ascertain if they intend to yield for you to exit. Watch for and yield to pedestrians waiting to cross, or crossing the exit leg. Watch out for and be particularly considerate of people with disabilities, children, and elderly pedestrians. Do not accelerate until you are beyond the pedestrian crossing point on the exit.

2.6.1.5 Turning at roundabouts

Unless signs or pavement markings indicate otherwise:

- **When turning right or exiting** at the first exit around the roundabout, use the following procedure:
 - Turn on your right-turn signal on the approach.
 - If there are multiple approach lanes, use only the right-hand lane.
 - Keep to the outside of the circulatory roadway within the roundabout and continue to use your right-turn signal through your exit.
 - When there are multiple exit lanes use the right-hand lane.
- **When going straight ahead** (i.e., exiting halfway around the roundabout), use the following procedure (see Exhibit 2-7):
 - **Do not use any turn signals on approach.**
 - If there are two approach lanes, you may use either the left- or right-hand approach lanes.
 - When on the circulatory roadway, turn on your right-turn signal once you have passed the exit before the one you want and continue to use your right-turn signal through your exit.
 - Maintain your inside (left) or outside (right) track throughout the roundabout if the circulatory roadway is wide. This means that if you entered using the inner (left) lane, circulate using the inside track of the circulatory roadway and exit from here by crossing the outside track. Likewise, if you entered using the outer (right) lane, circulate using the outside track of the circulatory roadway and exit directly from here. **Do not change lanes within the roundabout except when crossing the outer circulatory track in the act of exiting.**

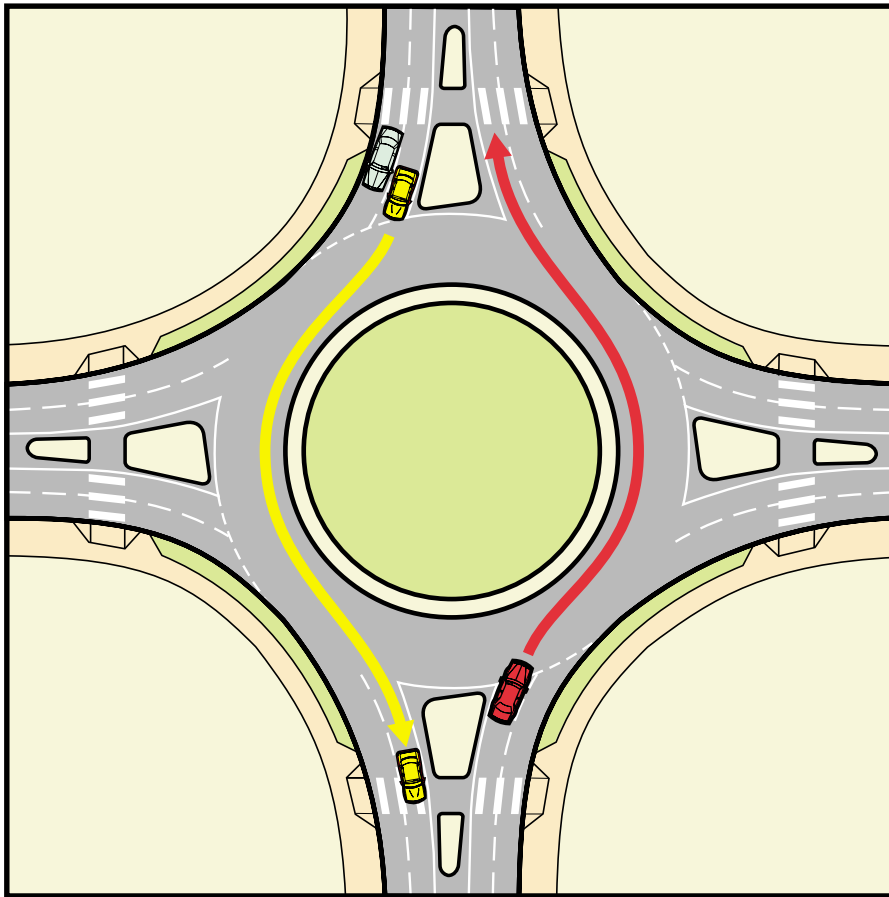
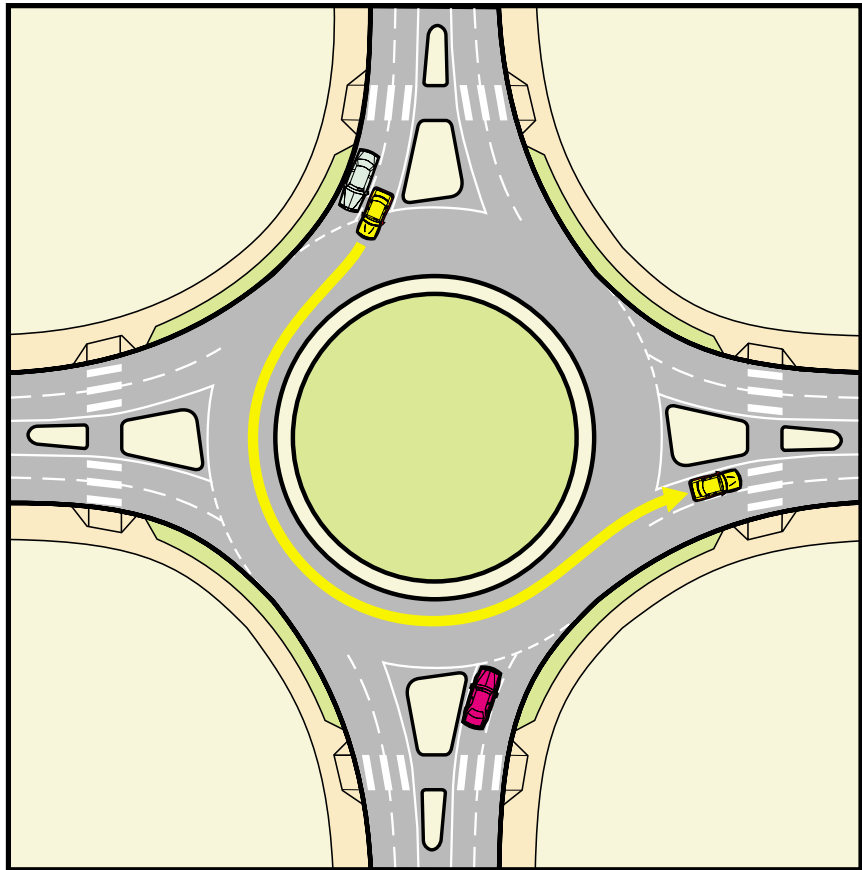

Exhibit 2-7. Driving straight through a roundabout.

Source: *The Highway Code (UK) (9)*, converted to right-hand drive

- When exiting the circulatory roadway from the inside track, watch out on the outside track for leading or adjacent vehicles that continue to circulate around the roundabout.
- When exiting the circulatory roadway from the outside track, yield to leading or adjacent vehicles that are exiting into the same lane.
- **When turning left or making a U-turn** (i.e., exiting more than halfway around the roundabout), use the following procedure (see Exhibit 2-8):
 - **Turn on your left turn signal.**
 - If there are multiple approach lanes, use only the left-hand lane.
 - Keep to the inner (left) side of the circulatory roadway (nearest the central island).
 - Continue to use your left-turn signal until you have passed the exit before the one you want, and then use your right-turn signal through your exit.
 - When exiting from a multilane roundabout from the inside part of the circulatory roadway, use only the inner lane on the exit (the lane nearest the splitter island). Watch out on the outside part of the circulatory roadway for leading or adjacent vehicles that continue to circulate around the roundabout.

Exhibit 2-8. Turning left at a roundabout.



Source: *The Highway Code* (UK) (9), converted to right-hand drive

- When in doubt about lane choice (especially for roundabouts with legs at angles other than $90\frac{1}{2}$), **use the following general rules to determine which lane you should be in** (unless signs or pavement markings indicate otherwise):
 - If you intend to exit the roundabout less than halfway around it, use the right lane.
 - If you intend to exit the roundabout more than halfway around it, use the left lane.

2.6.1.6 Motorcyclists and bicyclists

Watch out for motorcyclists and bicyclists. Give them plenty of room and show due consideration. Bicyclists may enter the approach roadway from a bicycle lane. Bicyclists will often keep to the right on the roundabout; they may also indicate left to show they are continuing around the roundabout. It is best to treat bicyclists as other vehicles and not pass them while on the circulatory roadway. Motorcyclists should not ride across the mountable truck apron next to the central island, if present.

2.6.1.7 Large vehicles

When car drivers approach a roundabout, do not overtake large vehicles. Large vehicles (for example, trucks and buses) may have to swing wide on the approach or within the roundabout. Watch for their turn signals and give them plenty of room, especially since they may obscure other conflicting users.

To negotiate a roundabout, drivers of large vehicles may need to use the full width of the roadway, including mountable aprons if provided. They should be careful of all other users of the roundabouts and, prior to entering the roundabout, satisfy themselves that other users are aware of them and will yield to them.

2.6.2 Bicyclist education

Bicyclists should likewise be educated about the operating characteristics of roundabouts. Well-designed, low-speed, single-lane roundabouts should not present much difficulty to bicyclists. They should enter these roundabouts just as they enter a stop sign or signal controlled intersection without auxiliary lanes (the bike lane terminates on the approach to these intersections, too). On the approach to the entry, a bicyclist should claim the lane. Right-turning cyclists should keep to the right side of the entry lane; others should be near the center of the lane.

Cyclists have three options upon approaching a roundabout:

- Travel on the circulatory roadway of the roundabout like motorists. When using a double-lane roundabout as a vehicle, obey all rules of the road for vehicles using roundabouts. However, you may feel safer approaching in the right-hand lane and keeping to the right in the roundabout (rather like making two through movements to turn left at a signalized intersection). If you do keep to the right, take extra care when crossing exits and signal left to show you are not leaving. Watch out for vehicles crossing your path to leave or join the roundabout. Watch out for large vehicles on the roundabout, as they need more space to maneuver. It may be safer to wait until they have cleared the roundabout. Or,
- If you are unsure about using the roundabout, dismount and exit the approach lane before the splitter island on the approach, and move to the sidewalk. Once on the sidewalk, walk your bicycle like a pedestrian. Or,
- Some roundabouts may have a ramp that leads to a widened sidewalk or a shared bicycle-pedestrian path that runs around the perimeter of the roundabout. If a ramp access is provided prior to the pedestrian crossing, you may choose to ramp up to curb level and traverse the sidewalk or path while acting courteously to pedestrians. A ramp may also be provided on the exit legs of a roundabout to reenter the roadway, after verifying that it is safe to do so.

2.6.3 Pedestrian education

Pedestrians have the right-of-way within crosswalks at a roundabout; however, pedestrians must not suddenly leave a curb or other safe waiting place and walk into the path of a vehicle if it is so close that it is an immediate hazard. This can be problematic if the design is such that a disabled pedestrian cannot accurately determine the gap. Specific education beyond these general instructions should be provided for disabled pedestrians to use any information provided for them.

- Do not cross the circulatory roadway to the central island. Walk around the perimeter of the roundabout.
- Use the crosswalks on the legs of the roundabout. If there is no crosswalk marked on a leg of the roundabout, cross the leg about one vehicle-length away (7.5 m [25 ft]) from the circulatory roadway of the roundabout. Locate the wheelchair ramps in the curbs. These are built in line with a grade-level opening in the median island. This opening is for pedestrians to wait before crossing the next roadway.

- Roundabouts are typically designed to enable pedestrians to cross one direction of traffic at a time. Look and listen for approaching traffic. Choose a safe time to cross from the curb ramp to the median opening (note that although you have the right-of-way, if approaching vehicles are present, it is prudent to first satisfy yourself that conflicting vehicles have recognized your presence and right to cross, through visual or audible cues such as vehicle deceleration or driver communication). If a vehicle slows for you to cross at a two-lane roundabout, be sure that conflicting vehicles in adjacent lanes have done likewise before accepting the crossing opportunity.
- Most roundabouts provide a raised median island halfway across the roadway; wait in the opening provided and choose a safe time to cross traffic approaching from the other direction.

2.7 References

1. Brown, M. *TRL State of the Art Review—The Design of Roundabouts*. London: HMSO, 1995.
2. Alphand, F, U. Noelle, and B. Guichet. "Roundabouts and Road Safety: State of the Art in France." In *Intersections without Traffic Signals II*, Springer-Verlag, Germany (W. Brilon, ed.), 1991, pp. 107–125.
3. Jacquemart, G. *Synthesis of Highway Practice 264: Modern Roundabout Practice in the United States*. National Cooperative Highway Research Program. Washington, D.C: National Academy Press, 1998.
4. Department of Transport (United Kingdom). "Killing Speed and Saving Lives." As reported in Oregon Department of Transportation, *Oregon Bicycle and Pedestrian Plan*, 1995.
5. Garder, P. *The Modern Roundabouts: The Sensible Alternative for Maine*. Maine Department of Transportation, Bureau of Planning, Research and Community Services, Transportation Research Division, 1998.
6. Niederhauser, M.E., B.A. Collins, and E.J. Myers. "The Use of Roundabouts: Comparison with Alternate Design Solution." *Compendium of Technical Papers*, 67th Annual Meeting, Institute of Transportation Engineers. August 1997.
7. Federal Highway Administration (FHWA). *Older Driver Highway Design Handbook*. Publication No. FHWA-RD-97-135. Washington, D.C.: FHWA, January 1998.
8. National Committee on Uniform Traffic Laws and Ordinances (NCUTLO). *Uniform Vehicle Code and Model Traffic Ordinance*. Evanston, Illinois: NCUTLO, 1992.
9. Department of Transport (United Kingdom). *The Highway Code*. Department of Transport and the Central Office of Information for Her Majesty's Stationery Office, 1996.
10. Australia. *Traffic Act*, Part 6A, 1962.
11. VicRoads. *Victorian Traffic Handbook*, Fourth Edition. Melbourne, Australia: Roads Corporation, 1998.



Planning

3.1	Planning Steps	51
3.2	Considerations of Context	53
3.2.1	Decision environments	53
3.2.2	Site-specific conditions	54
3.3	Number of Entry Lanes	55
3.3.1	Single- and double-lane roundabouts	56
3.3.2	Mini-roundabouts	56
3.4	Selection Categories	58
3.4.1	Community enhancement	58
3.4.2	Traffic calming	58
3.4.3	Safety improvement	59
3.4.4	Operational improvement	62
3.4.5	Special situations	63
3.5	Comparing Operational Performance of Alternative Intersection Types	64
3.5.1	Two-way stop-control alternative	64
3.5.2	All-way stop-control alternative	65
3.5.3	Signal control alternative	67
3.6	Space Requirements	69
3.7	Economic Evaluation	70
3.7.1	Methodology	73
3.7.2	Estimating benefits	73
3.7.3	Estimation of costs	75
3.8	References	76

Exhibit 3-1.	Maximum daily service volumes for a four-leg roundabout.	57
Exhibit 3-2.	Planning-level maximum daily service volumes for mini-roundabouts.	57
Exhibit 3-3.	Example of community enhancement roundabout.	59
Exhibit 3-4.	Example of traffic calming roundabouts.	60
Exhibit 3-5.	Comparison of predicted rural roundabout injury crashes with rural TWSC intersections.	61
Exhibit 3-6.	Model comparison of predicted injury crashes for single-lane and double-lane roundabouts with rural or urban signalized intersections.	61
Exhibit 3-7.	Average delay per vehicle at the MUTCD peak hour signal warrant threshold (excluding geometric delay).	63
Exhibit 3-8.	Comparison of TWSC and single-lane roundabout capacity.	65
Exhibit 3-9.	Sample hourly distribution of traffic.	66
Exhibit 3-10.	Annual savings in delay of single-lane roundabout versus AWSC, 50 percent of volume on the major street.	67
Exhibit 3-11.	Annual savings in delay of single-lane roundabout versus AWSC, 65 percent of volume on the major street.	67
Exhibit 3-12.	Delay savings for roundabout vs. signal, 50 percent volume on major street.	69
Exhibit 3-13.	Delay savings for roundabout vs. signal, 65 percent volume on major street.	69
Exhibit 3-14.	Assumptions for spatial comparison of roundabouts and comparable conventional intersections.	70
Exhibit 3-15.	Area comparison: Urban compact roundabout vs. comparable signalized intersection.	71
Exhibit 3-16.	Area comparison: Urban single-lane roundabout vs. comparable signalized intersection.	71
Exhibit 3-17.	Area comparison: Urban double-lane roundabout vs. comparable signalized intersection.	72
Exhibit 3-18.	Area comparison: Urban flared roundabout vs. comparable signalized intersection.	72
Exhibit 3-19.	Estimated costs for crashes of varying levels of severity.	74

Chapter 3 Planning

Chapter 1 presented a range of roundabout categories, and suggested typical daily service volume thresholds below which four-leg roundabouts may be expected to operate, without requiring a detailed capacity analysis. Chapter 2 introduced roundabout performance characteristics, including comparisons with other intersection forms and control, which will be expanded upon in this chapter. This chapter covers the next steps that lead up to the decision to construct a roundabout with an approximate configuration at a specific location, preceding the detailed analysis and design of a roundabout. By confirming that there is good reason to believe that roundabout construction is feasible and that a roundabout offers a sensible method of accommodating the traffic demand, these planning activities make unnecessary the expenditure of effort required in subsequent chapters.

Planning for roundabouts begins with specifying a preliminary configuration. The configuration is specified in terms of the minimum number of lanes required on each approach and, thus, which roundabout category is the most appropriate basis for design: urban or rural, single-lane or double-lane roundabout. Given sufficient space, roundabouts can be designed to accommodate high traffic volumes. There are many additional levels of detail required in the design and analysis of a high-capacity, multi-lane roundabout that are beyond the scope of a planning level procedure. Therefore, this chapter focuses on the more common questions that can be answered using reasonable assumptions and approximations.

Feasibility analysis requires an approximation of some of the design parameters and operational characteristics. Some changes in these approximations may be necessary as the design evolves. A more detailed methodology for performing the operational evaluation and geometric design tasks is presented later in Chapters 4 and 6 of this guide, respectively.

3.1 Planning Steps

The following steps may be followed when deciding whether to implement a roundabout at an intersection:

- Step 1: Consider the context. What are there regional policy constraints that must be addressed? Are there site-specific and community impact reasons why a roundabout of any particular size would not be a good choice? (Section 3.2)
- Step 2: Determine a preliminary lane configuration and roundabout category based on capacity requirements (Section 3.3). Exhibit 3-1 will be useful for making a basic decision on the required number of lanes. If Exhibit 3-1 indicates that more than one lane is required on any approach, refer to Chapters 4 and 6 for the more detailed analysis and design procedures. Otherwise, proceed with the planning procedure.
- Step 3: Identify the selection category (Section 3.4). This establishes why a roundabout may be the preferred choice and determines the need for specific information.

Planning determines whether a roundabout is even feasible, before expending the effort required in subsequent steps.

Some of the assumptions and approximations used in planning may change as the design evolves, but are sufficient at this stage to answer many common questions.

- Step 4: Perform the analysis appropriate to the selection category. If the selection is to be based on operational performance, use the appropriate comparisons with alternative intersections (Section 3.5).
- Step 5: Determine the space requirements. Refer to Section 3.6 and Appendix B for the right-of-way widths required to accommodate the inscribed circle diameter. Determine the space feasibility. Is there enough right-of-way to build it? This is a potential rejection point. There is no operational reason to reject a roundabout because of the need for additional right-of-way; however, right-of-way acquisition introduces administrative complications that many agencies would prefer to avoid.
- Step 6: If additional space must be acquired or alternative intersection forms are viable, an economic evaluation may be useful (Section 3.7).

The results of the steps above should be documented to some extent. The level of detail in the documentation will vary among agencies and will generally be influenced by the size and complexity of the roundabout. A roundabout selection study report may include the following elements:

Suggested contents of a roundabout selection study report.

- It may identify the selection category that specifies why a roundabout is the logical choice at this intersection;
- It may identify current or projected traffic control or safety problems at the intersection if the roundabout is proposed as a solution to these problems;
- It may propose a configuration, in terms of number of lanes on each approach;
- It may demonstrate that the proposed configuration can be implemented feasibly and that it will provide adequate capacity on all approaches; and
- It may identify all potential complicating factors, assess their relevance to the location, and identify any mitigation efforts that might be required.

Agencies that require a more complete or formal rationale may also include the following additional considerations:

- It may demonstrate institutional and community support indicating that key institutions (e.g., police, fire department, schools, etc.) and key community leaders have been consulted;
- It may give detailed performance comparisons of the roundabout with alternative control modes;
- It may include an economic analysis, indicating that a roundabout compares favorably with alternative control modes from a benefit-cost perspective; and
- It may include detailed appendices containing traffic volume data, signal, or all-way stop control (AWSC) warrant analysis, etc.

None of these elements should be construed as an absolute requirement for documentation. The above list is presented as a guide to agencies who choose to prepare a roundabout study report.

3.2 Considerations of Context

3.2.1 Decision environments

There are three somewhat different policy environments in which a decision may be made to construct a roundabout at a specific location. While the same basic analysis tools and concepts apply to all of the environments, the relative importance of the various aspects and observations may differ, as may prior constraints that are imposed at higher policy levels.

A new roadway system: Fewer constraints are generally imposed if the location under consideration is not a part of an existing roadway system. Right-of-way is usually easier to acquire or commit. Other intersection forms also offer viable alternatives to roundabouts. There are generally no field observations of site-specific problems that must be addressed. This situation is more likely to be faced by developers than by public agencies.

The first roundabout in an area: The first roundabout in any geographic area requires an implementing agency to perform due diligence on roundabouts regarding their operational and design aspects, community impacts, user needs, and public acceptability. On the other hand, a successfully implemented roundabout, especially one that solves a perceived problem, could be an important factor in gaining support for future roundabouts at locations that could take advantage of the potential benefits that roundabouts may offer. Some important considerations for this decision environment include:

- Effort should be directed toward gaining community and institutional support for the selection of a site for the first roundabout in an area. Public acceptance for roundabouts, like any new roadway facility, require agency staff to understand the potential issues and communicate these effectively with the impacted community;
- An extensive justification effort may be necessary to gain the required support;
- A cautious and conservative approach may be appropriate; careful consideration should be given to conditions that suggest that the benefits of a roundabout might not be fully realized. Collecting data on current users of the facility can provide important insights regarding potential issues and design needs;
- A single-lane roundabout in the near-term is more easily understood by most drivers and therefore may have a higher probability of acceptance by the motoring public;
- The choice of design and analysis procedures could set a precedent for future roundabout implementation; therefore, the full range of design and analysis alternatives should be explored in consultation with other operating agencies in the region; and
- After the roundabout is constructed, evaluating its operation and the public response could provide documentation to support future installations.

Retrofit to an existing intersection in an area where roundabouts have already gained acceptance: This environment is one in which a solution to a site-specific problem is being sought. Because drivers are familiar with roundabout operation, a less intensive process may suffice. Double-lane roundabouts could be considered, and the regional design and evaluation procedures should have already been agreed

Will the roundabout be...

- **Part of a new roadway?**
- **The first in an area?**
- **A retrofit of an existing intersection?**

The first roundabout in an area requires greater education and justification efforts. Single-lane roundabouts will be more easily understood initially than multilane roundabouts.

upon. The basic objectives of the selection process in this case are to demonstrate the community impacts and that a roundabout will function properly during the peak period within the capacity limits imposed by the space available; and to decide whether one is the preferred alternative. If the required configuration involves additional right-of-way, a more detailed analysis will probably be necessary, using the methodology described in Chapter 4.

Many agencies that are contemplating the construction of their first roundabout are naturally reluctant to introduce complications, such as double-lane, yield-controlled junctions, which are not used elsewhere in their jurisdiction. It is also a common desire to avoid intersection designs that require additional right-of-way, because of the effort and expense involved in right-of-way acquisition. Important questions to be addressed in the planning phase are therefore:

- Will a minimally configured roundabout (i.e., single-lane entrances and circulatory roadway) provide adequate capacity and performance for all users, or will additional lanes be required on some legs or at some future time?
- Can the roundabout be constructed within the existing right-of-way, or will it be necessary to acquire additional space beyond the property lines?
- Can a single-lane roundabout be upgraded in the future to accommodate growth?

If not, a roundabout alternative may require that more rigorous analysis and design be conducted before a decision is made.

3.2.2 Site-specific conditions

Some conditions may preclude a roundabout at a specific location. Certain site-related factors may significantly influence the design and require a more detailed investigation of some aspects of the design or operation. A number of these factors (many of which are valid for any intersection type) are listed below:

Site-specific factors that may significantly influence a roundabout's design.

- Physical or geometric complications that make it impossible or uneconomical to construct a roundabout. These could include right-of-way limitations, utility conflicts, drainage problems, etc.
- Proximity of generators of significant traffic that might have difficulty negotiating the roundabout, such as high volumes of oversized trucks.
- Proximity of other traffic control devices that would require preemption, such as railroad tracks, drawbridges, etc.
- Proximity of bottlenecks that would routinely back up traffic into the roundabout, such as over-capacity signals, freeway entrance ramps, etc. The successful operation of a roundabout depends on unimpeded flow on the circulatory roadway. If traffic on the circulatory roadway comes to a halt, momentary intersection gridlock can occur. In comparison, other control types may continue to serve some movements under these circumstances.
- Problems of grades or unfavorable topography that may limit visibility or complicate construction.
- Intersections of a major arterial and a minor arterial or local road where an unacceptable delay to the major road could be created. Roundabouts delay and deflect all traffic entering the intersection and could introduce excessive delay or speed inconsistencies to flow on the major arterial.

- Heavy pedestrian or bicycle movements in conflict with high traffic volumes. (These conflicts pose a problem for all types of traffic control. There is very little experience on this topic in the U.S., mostly due to a lack of existing roundabout sites with heavy intermodal conflicts).
- Intersections located on arterial streets within a coordinated signal network. In these situations, the level of service on the arterial might be better with a signalized intersection incorporated into the system. Chapter 8 deals with system considerations for roundabouts.

The existence of one or more of these conditions does not necessarily preclude the installation of a roundabout. Roundabouts have, in fact, been built at locations that exhibit nearly all of the conditions listed above. Such factors may be resolved in several ways:

- They may be determined to be insignificant at the specific site;
- They may be resolved by operational modeling or specific design features that indicate that no significant problems will be created;
- They may be resolved through coordination with and support from other agencies, such as the local fire department; and
- In some cases, specific mitigation actions may be required.

All complicating factors should be resolved prior to the choice of a roundabout as the preferred intersection alternative.

The effect of a particular factor will often depend on the degree to which roundabouts have been implemented in the region. Some conditions would not be expected to pose problems in areas where roundabouts are an established form of control that is accepted by the public. On the other hand, some conditions, such as heavy pedestrian volumes, might suggest that the installation of a roundabout be deferred until this control mode has demonstrated regional acceptance. Most agencies have an understandable reluctance to introduce complications at their first roundabout.

3.3 Number of Entry Lanes

A basic question that needs to be answered is how many entry lanes a roundabout would require to serve the traffic demand. The capacity of a roundabout is clearly a critical parameter and one that should be checked at the outset of any feasibility study. Chapter 4 offers a detailed capacity computation procedure, mostly based on experiences in other countries. Some assumptions and approximations have been necessary in this chapter to produce a planning-level approach for deciding whether or not capacity is sufficient.

Since this is the first of several planning procedures to be suggested in this chapter, some discussion of the assumptions and approximations is appropriate. First, traffic volumes are generally represented for planning purposes in terms of Average Daily Traffic (ADT), or Average Annual Daily Traffic (AADT). Traffic operational analyses must be carried out at the design hour level. This requires an assumption of a K factor and a D factor to indicate, respectively, the proportion of the AADT

assigned to the design hour, and the proportion of the two-way traffic that is assigned to the peak direction. All of the planning-level procedures offered in this chapter were based on reasonably typical assumed values for K of 0.1 and D of 0.58.

There are two site-specific parameters that must be taken into account in all computations. The first is the proportion of traffic on the major street. For roundabout planning purposes, this value was assumed to lie between 0.5 and 0.67. All analyses assumed a four-leg intersection. The proportion of left turns must also be considered, since left turns affect all traffic control modes adversely. For the purposes of this chapter, a reasonably typical range of left turns were examined. Right turns were assumed to be 10 percent in all cases. Right turns are included in approach volumes and require capacity, but are not included in the circulating volumes downstream because they exit before the next entrance.

The capacity evaluation is based on values of entering and circulating traffic volumes as described in Chapter 4. The AADT that can be accommodated is conservatively estimated as a function of the proportion of left turns, for cross-street volume proportions of 50 percent and 67 percent. For acceptable roundabout operation, many sources advise that the volume-to-capacity ratio on any leg of a roundabout not exceed 0.85 (1, 2). This assumption was used in deriving the AADT maximum service volume relationship.

The volume-to-capacity ratio of any roundabout leg is recommended not to exceed 0.85.

3.3.1 Single- and double-lane roundabouts

The resulting maximum service volumes are presented in Exhibit 3-1 for a range of left turns from 0 to 40 percent of the total volume. This range exceeds the normal expectation for left turn proportions. This procedure is offered as a simple, conservative method for estimating roundabout lane requirements. If the 24-hour volumes fall below the volumes indicated in Exhibit 3-1, a roundabout should have no operational problems at any time of the day. It is suggested that a reasonable approximation of lane requirements for a three-leg roundabout may be obtained using 75 percent of the service volumes shown on Exhibit 3-1.

If the volumes exceed the threshold suggested in Exhibit 3-1, a single-lane or double-lane roundabout may still function quite well, but a closer look at the actual turning movement volumes during the design hour is required. The procedures for such analysis are presented in Chapter 4.

3.3.2 Mini-roundabouts

Mini-roundabouts are distinguished from traditional roundabouts primarily by their smaller size and more compact geometry. They are typically designed for negotiation speeds of 25 km/h (15 mph). Inscribed circle diameters generally vary from 13 m to 25 m (45 ft to 80 ft). Mini-roundabouts are usually implemented with safety in mind, as opposed to capacity. Peak-period capacity is seldom an issue, and most mini-roundabouts operate on residential or collector streets at demand levels well below their capacity. It is important, however, to be able to assess the capacity of any proposed intersection design to ensure that the intersection would function properly if constructed.

At very small roundabouts, it is reasonable to assume that each quadrant of the circulatory roadway can accommodate only one vehicle at a time. In other words,

a vehicle may not enter the circulatory roadway unless the quadrant on both sides of the approach is empty. Given a set of demand volumes for each of the 12 standard movements at a four-leg roundabout, it is possible to simulate the roundabout to estimate the maximum service volumes and delay for each approach. By making assumptions about the proportion of left turns and the proportion of cross street traffic, a general estimate of the total entry maximum service volumes of the roundabout can be made, and is provided in Exhibit 3-2. AADT maximum service volumes are represented based on an assumed K value of 0.10. Note that these volumes range from slightly more than 12,000 to slightly less than 16,000 vehicles per day. The maximum throughput is achieved with an equal proportion of vehicles on the major and minor roads, and with low proportions of left turns.

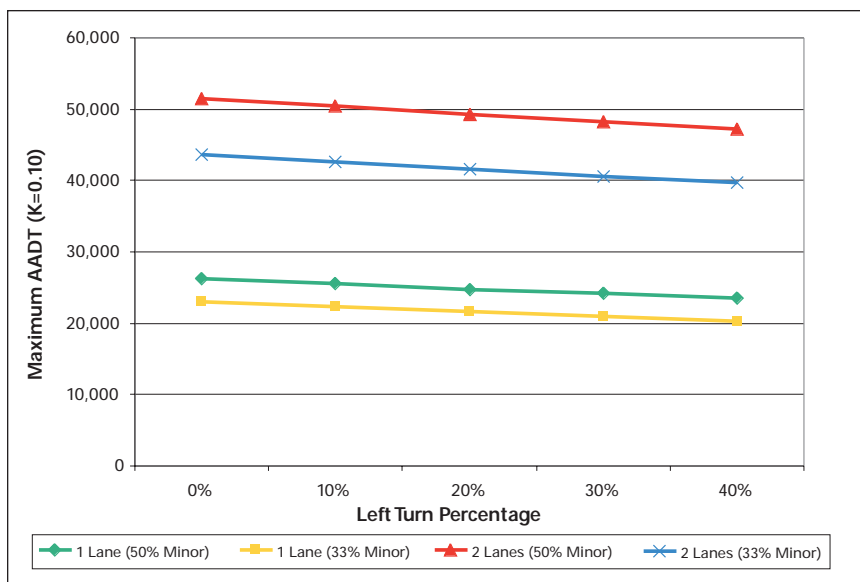

Exhibit 3-1. Maximum daily service volumes for a four-leg roundabout.

For three-leg roundabouts, use 75 percent of the maximum AADT volumes shown.

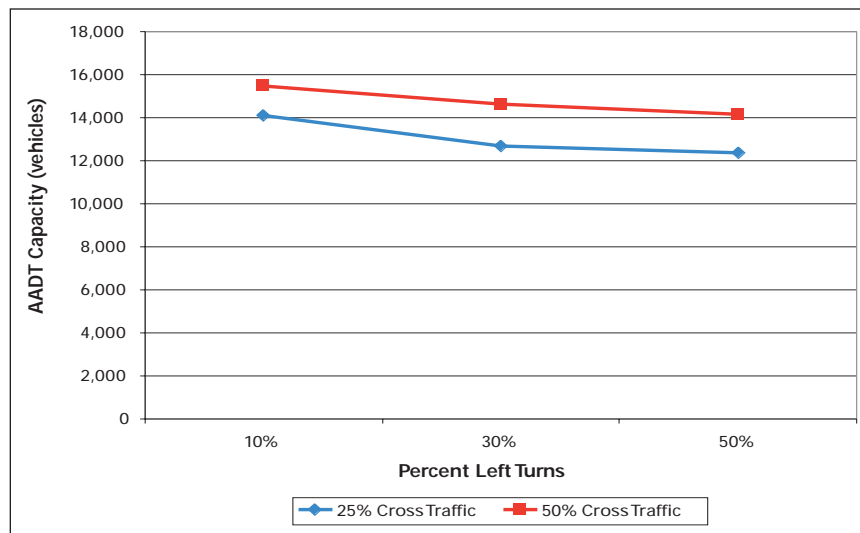

Exhibit 3-2. Planning-level maximum daily service volumes for mini-roundabouts.

3.4 Selection Categories

There are many locations at which a roundabout could be selected as the preferred traffic control mode. There are several reasons why this is so, and each reason creates a separate selection category. Each selection category, in turn, requires different information to demonstrate the desirability of a roundabout. The principal selection categories will be discussed in this section, along with their information requirements.

A wide range of roundabout policies and evaluation practices exists among operating agencies within the U.S. For example, the Florida Department of Transportation requires a formal “justification report” to document the selection of a roundabout as the most appropriate traffic control mode at any intersection on their State highway system. On the other hand, private developers may require no formal rationalization of any kind. It is interesting to note that the Maryland Department of Transportation requires consideration of a roundabout as an alternative at all intersections proposed for signalization.

It is reasonable that the decision to install a roundabout should require approximately the same level of effort as the alternative control mode. In other words, if a roundabout is proposed as an alternative to a traffic signal, then the analysis effort should be approximately the same as that required for a signal. If the alternative is stop sign control, then the requirements could be relaxed.

The following situations present an opportunity to demonstrate the desirability of installing a roundabout at a specific location.

3.4.1 Community enhancement

Roundabouts have been proposed as a part of a community enhancement project and not as a solution to capacity problems. Such projects are often located in commercial and civic districts, as a gateway treatment to convey a change of environment and to encourage traffic to slow down. Traffic volumes are typically well below the thresholds shown in Exhibit 3-1; otherwise, one of the more operationally oriented selection categories would normally be more appropriate.

Roundabouts proposed for community enhancement require minimal analysis as a traffic control device. The main focus of the planning procedure should be to demonstrate that they would not introduce traffic problems that do not exist currently. Particular attention should be given to any complications that would imply either operational or safety problems. The urban compact category may be the most appropriate roundabout for such applications. Exhibit 3-3 provides an example of a roundabout installed primarily for community enhancement.

3.4.2 Traffic calming

The decision to install a roundabout for traffic calming purposes should be supported by a demonstrated need for traffic calming along the intersecting roadways. Most of the roundabouts in this category will be located on local roads. Examples of conditions that might suggest a need for traffic calming include:

- Documented observations of speeding, high traffic volumes, or careless driving activities;

The planning focus for community enhancement roundabouts should be to demonstrate that they will not create traffic problems that do not now exist.

Conditions that traffic calming roundabouts may address.



Naples, FL

Exhibit 3-3. Example of community enhancement roundabout.

- Inadequate space for roadside activities, or a need to provide slower, safer conditions for non-automobile users; or
- New construction (road opening, traffic signal, new road, etc.) which would potentially increase the volumes of “cut-through” traffic.

Capacity should be an issue when roundabouts are installed for traffic calming purposes only because traffic volumes on local streets will usually be well below the level that would create congestion. If this is not the case, another primary selection category would probably be more suitable. The urban mini-roundabout or urban compact roundabout are most appropriate for traffic calming purposes. Exhibit 3-4 provides an example of roundabouts installed primarily for traffic calming.

3.4.3 Safety improvement

The decision to install a roundabout as a safety improvement should be based on a demonstrated safety problem of the type susceptible to correction by a roundabout. A review of crash reports and the type of accidents occurring is essential. Examples of safety problems include:

- High rates of crashes involving conflicts that would tend to be resolved by a roundabout (right angle, head-on, left/through, U-turns, etc.);
- High crash severity that could be reduced by the slower speeds associated with roundabouts;

Safety issues that roundabouts may help correct.

Exhibit 3-4. Example of traffic calming roundabouts.



Naples, FL

- Site visibility problems that reduce the effectiveness of stop sign control (in this case, landscaping of the roundabout needs to be carefully considered); and
- Inadequate separation of movements, especially on single-lane approaches.

Chapter 5 should be consulted for a more detailed analysis of the safety characteristics of roundabouts. There are currently a small number of roundabouts and therefore a relatively small crash record data base in the U.S. Therefore, it has not been possible to develop a national crash model for this intersection type. Roundabout crash prediction models have been developed for the United Kingdom (3). Crash models for conventional intersections in the United States are available (4, 5). Although crash data reporting may not be consistent between the U.K. and the U.S., comparison is plausible. The two sets of models have a key common measure of effectiveness in terms of injury and fatal crash frequency.

Therefore, for illustrative purposes, Exhibit 3-5 provides the results of injury crash prediction models for various ADT volumes of roundabouts versus rural TWSC intersections (6). The comparison shown is for a single-lane approach, four-leg roundabout with single-lane entries, and good geometric design. For the TWSC rural intersection model, the selected variables include rolling terrain, the main road as major collector, and a design speed of 80 km/h (50 mph). Rural roundabouts may experience approximately 66 percent fewer injury crashes than rural TWSC intersections for 10,000 entering ADT, and approximately 64 percent fewer crashes for 20,000 ADT. At urban roundabouts, the reduction will probably be smaller.

Also for illustration, Exhibit 3-6 provides the results of injury crash prediction models for various average daily traffic volumes at roundabouts versus rural and urban signalized intersections (6). The selected variables of the crash model for signalized (urban/suburban) intersections include multiphase fully-actuated signal, with a speed of 80 km/h (50 mph) on the major road. The 20,000 entering ADT is applied to single-lane roundabout approaches with four-legs. The 40,000 ADT is applied to double-lane roundabout approaches without flaring of the roundabout entries. In comparison to signalized intersections, roundabouts may experience approximately

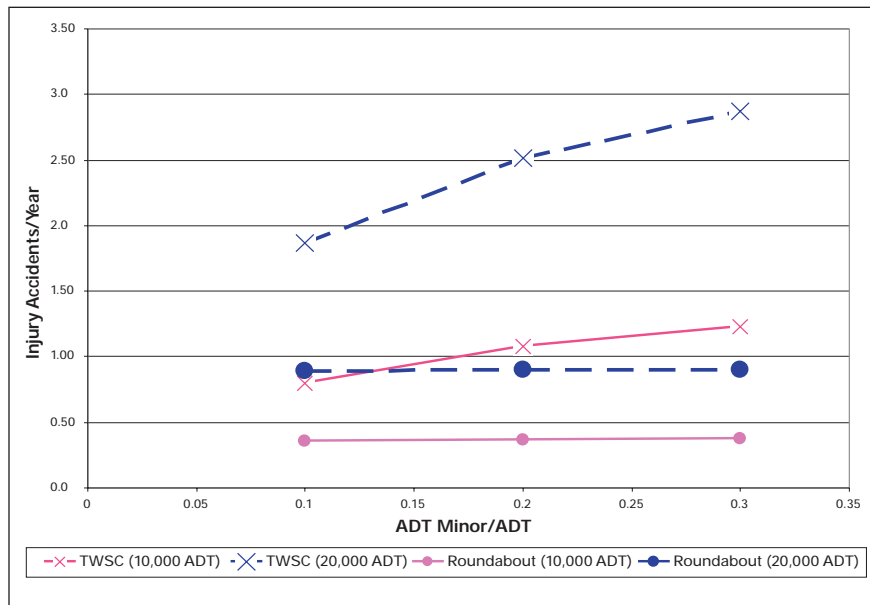

Exhibit 3-5. Comparison of predicted roundabout injury crashes with rural TWSC intersections.

Roundabouts have fewer annual injury crashes than rural two-way stop-controlled intersections, and the total number of crashes at roundabouts is relatively insensitive to minor street demand volumes.

Source: (6)

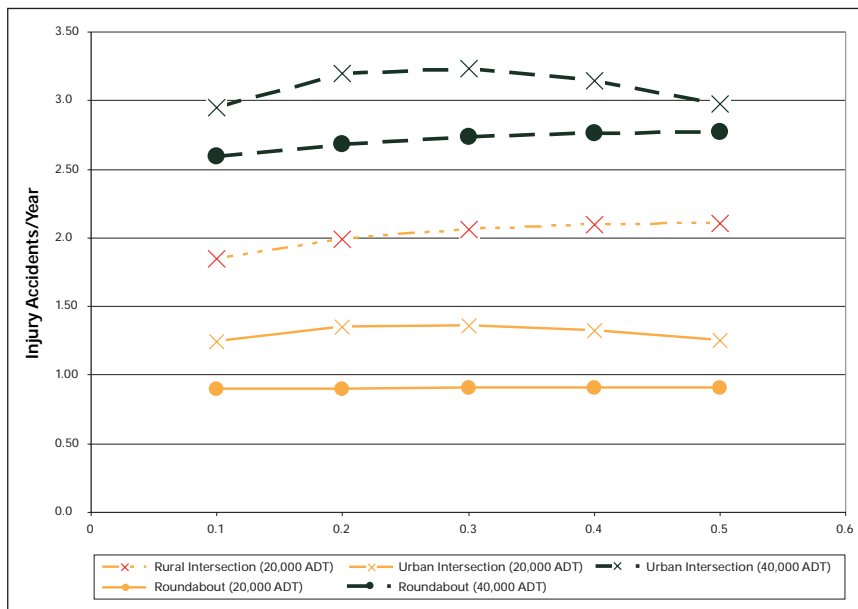

Exhibit 3-6. Comparison of predicted injury crashes for single-lane and double-lane roundabouts with rural or urban signalized intersections.

Roundabouts have fewer injury accidents per year than signalized intersections, particularly in rural areas. At volumes greater than 50,000 ADT, urban roundabout safety may be comparable to that of urban signalized intersections.

Source: (6)

33 percent fewer injury crashes in urban and suburban areas and 56 percent fewer crashes in rural areas for 20,000 entering ADT. For 40,000 entering ADT, this reduction may only be about 15 percent in urban areas. Therefore, it is likely that roundabout safety may be comparable to signalized intersections at higher ADT (greater than 50,000).

These model comparisons are an estimation of mean crash frequency or average safety performance from a random sample of four-leg intersections from different countries and should be supplemented by engineering judgment and attention to safe design for all road users.

General delay and capacity comparisons between roundabouts and other forms of intersection control.

3.4.4 Operational improvement

A roundabout may be considered as a logical choice if its estimated performance is better than alternative control modes, usually either stop or signal control. The performance evaluation models presented in the next chapter provide a sound basis for comparison, but their application may require more effort and resources than an agency is prepared to devote in the planning stage. To simplify the selection process, the following assumptions are proposed for a planning-level comparison of control modes:

1. A roundabout will always provide a higher capacity and lower delays than AWSC operating with the same traffic volumes and right-of-way limitations.
2. A roundabout is unlikely to offer better performance in terms of lower overall delays than TWSC at intersections with minor movements (including cross street entry and major street left turns) that are not experiencing, nor predicted to experience, operational problems under TWSC.
3. A single-lane roundabout may be assumed to operate within its capacity at any intersection that does not exceed the peak-hour volume warrant for signals.
4. A roundabout that operates within its capacity will generally produce lower delays than a signalized intersection operating with the same traffic volumes and right-of-way limitations.

The above assumptions are documented in the literature (7) or explained by the analyses in Section 3.5. Collectively, they provide a good starting point for further analysis using procedures in Chapter 4. Although a roundabout may be the optimal control type from a vehicular operation standpoint, the relative performance of this control alternative for other modes should also be taken into consideration, as explained in Chapter 4.

3.4.4.1 Roundabout performance at flow thresholds for peak hour signal warrants

There are no warrants for roundabouts included in the *Manual of Uniform Traffic Control Devices* (MUTCD) (8), and it may be that roundabouts are not amenable to a warranting procedure. In other words, each roundabout should be justified on its own merits as the most appropriate intersection treatment alternative. It is, however, useful to consider the case in which the traffic volumes just meet the MUTCD warrant thresholds for traffic signals. For purposes of this discussion, the MUTCD peak hour warrant will be applied with a peak hour factor (PHF) of 0.9. Thus, the evaluation will reflect the performance in the heaviest 15 minutes of the peak hour.

Roundabout delays were compared with the corresponding values for TWSC, AWSC, and signals. A single-lane roundabout was assumed because the capacity of a single lane roundabout was adequate for all cases at the MUTCD volume warrant thresholds. SIDRA analysis software was used to estimate the delay for the various control alternatives because SIDRA was the only program readily available at the time this guide was developed that modeled all of the control alternatives (9).

The MUTCD warrant thresholds are given in terms of the heaviest minor street volume and sum of the major street volumes. Individual movement volumes may be obtained from the thresholds by assuming a directional factor, *D*, and left turn proportions. A "D" factor of 0.58 was applied to this example. Left turns on all approaches were assumed to be 10 to 50 percent of the total approach volume. In

determining the MUTCD threshold volumes, two lanes were assumed on the major street and one lane on the minor street.

Based on these assumptions, the average delays per vehicle for signals and roundabouts are presented in Exhibit 3-7. These values represent the approach delay as perceived by the motorist. They do not include the geometric delay incurred within the roundabout. It is clear from this figure that roundabout control delays are substantially lower than signal delays, but in neither case are the delays excessive.

Similar comparisons are not presented for TWSC, because the capacity for minor street vehicles entering the major street was exceeded in all cases at the signal

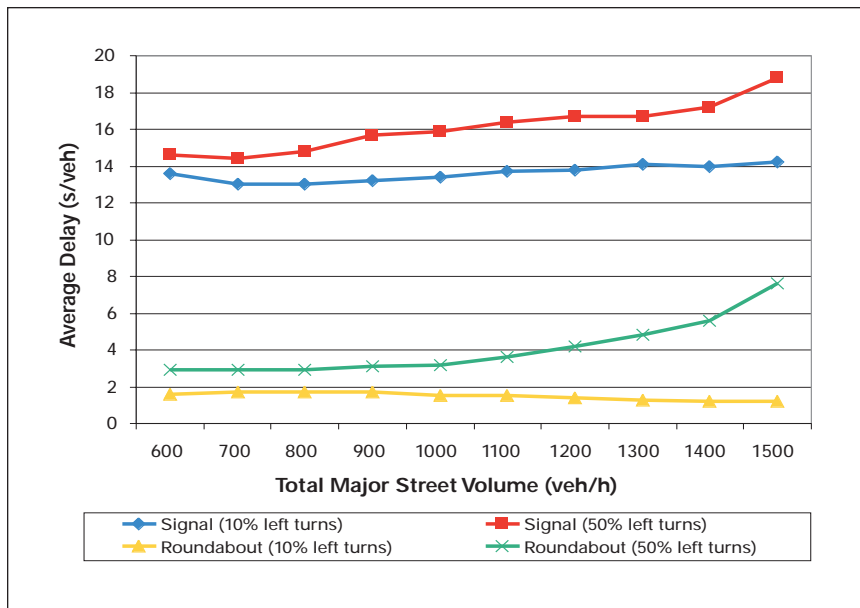

Exhibit 3-7. Average delay per vehicle at the MUTCD peak hour signal warrant threshold (excluding geometric delay).

Roundabout approach delay is relatively insensitive to total major street volume, but is sensitive to the left-turn percentage.

warrant thresholds. AWSC was found to be feasible only under a limited range of conditions: a maximum of 20 percent left turns can be accommodated when the major street volume is low and only 10 percent can be accommodated when the major street volume is high. Note that the minor street volume decreases as the major street volume increases at the signal warrant threshold.

This analysis of alternative intersection performance at the MUTCD peak hour volume signal warrant thresholds indicates that the single-lane roundabout is very competitive with all other forms of intersection control.

3.4.5 Special situations

It is important that the selection process not discourage the construction of a roundabout at any location where a roundabout would be a logical choice. Some flexibility must be built into the process by recognizing that the selection categories above are not all-inclusive. There may still be other situations that suggest that a roundabout would be a sensible control choice. Many of these situations are associated with unusual alignment or geometry where other solutions are intractable.

3.5 Comparing Operational Performance of Alternative Intersection Types

If a roundabout is being considered for operational reasons, then it may be compared with other feasible intersection control alternatives such as TWSC, AWSC, or signal control. This section provides approximate comparisons suitable for planning.

3.5.1 Two-way stop-control alternative

The majority of intersections in the U.S. operate under TWSC, and most of those intersections operate with minimal delay. The installation of a roundabout at a TWSC intersection that is operating satisfactorily will be difficult to justify on the basis of performance improvement alone, and one of the previously described selection categories is likely to be more appropriate.

The two most common problems at TWSC intersections are congestion on the minor street caused by a demand that exceeds capacity, and queues that form on the major street because of inadequate capacity for left turning vehicles yielding to opposing traffic. Roundabouts may offer an effective solution to traffic problems at TWSC intersections with heavy left turns from the major route because they provide more favorable treatment to left turns than other control modes. "T" intersections are especially good candidates in this category because they tend to have higher left turning volumes.

On the other hand, the problems experienced by low-volume cross street traffic at TWSC intersections with heavy through volumes on the major street are very difficult to solve by any traffic control measure. Roundabouts are generally not the solution to this type of problem because they create a significant impediment to the major movements. This situation is typical of a residential street intersection with a major arterial. The solution in most cases is to encourage the residential traffic to enter the arterial at a collector road with an intersection designed to accommodate higher entering volumes. The proportion of traffic on the major street is an important consideration in the comparison of a roundabout with a conventional four-leg intersection operating under TWSC. High proportions of minor street traffic tend to favor roundabouts, while low proportions favor TWSC.

An example of this may be seen in Exhibit 3-8, which shows the AADT capacity for planning purposes as a function of the proportion of traffic on the major street. The assumptions in this exhibit are the same as those that have been described previously in Section 3.3. Constant proportions of 10 percent right turns (which were ignored in roundabout analysis) and 20 percent left turns were used for all movements. As expected, the roundabout offers a much higher capacity at lower proportions of major street traffic. When the major and minor street volumes are equal, the roundabout capacity is approximately double that of the TWSC intersection. It is interesting to note that the two capacity values converge at the point where the minor street proportion becomes negligible. This effect confirms the expectation that a roundabout will have approximately the same capacity as a stop-controlled intersection when there is no cross street traffic.

Roundabouts may offer an effective solution at TWSC intersections with heavy left turns from the major street.

Roundabouts work better when the proportion of minor street traffic is higher.

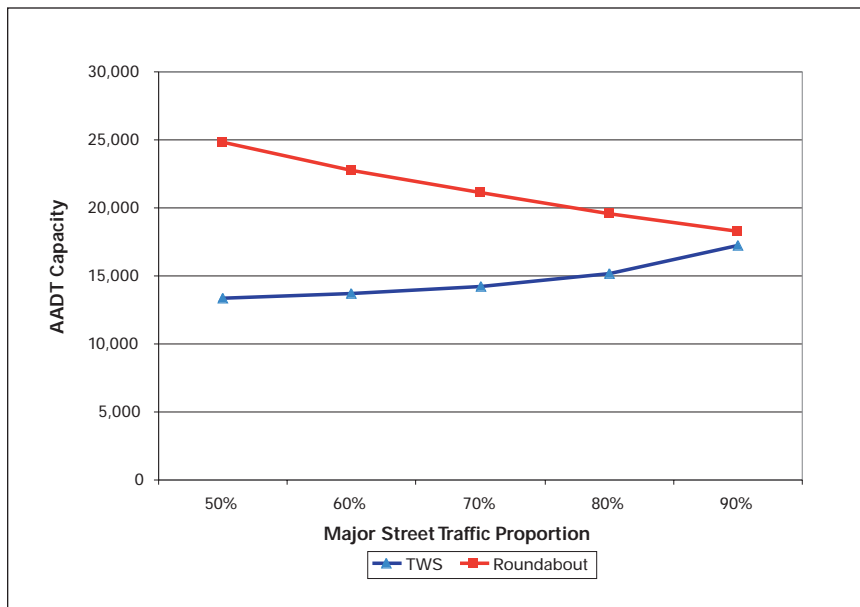

Exhibit 3-8. Comparison of TWSC and single-lane roundabout capacity.

Roundabout capacity decreases as the proportion of minor street entering traffic decreases. Roundabouts and TWSC intersections have about the same capacity when the minor street proportion is less than 10 percent.

3.5.2 All-way stop-control alternative

When cross street traffic volumes are heavy enough to meet the MUTCD warrants for AWSC control, roundabouts become an especially attractive solution because of their higher capacities and lower delays. The selection of a roundabout as an alternative to AWSC should emphasize cost and safety considerations, because roundabouts always offer better performance for vehicles than AWSC, given the same traffic conditions. Roundabouts that are proposed as alternatives to stop control would typically have single-lane approaches.

A substantial part of the benefit of a roundabout compared to an all-way stop intersection is obtained during the off-peak periods, because the restrictive stop control applies for the entire day. The MUTCD does not permit stop control on a part-time basis. The extent of the benefit will depend on the amount of traffic at the intersection and on the proportion of left turns. Left turns degrade the operation of all traffic control modes, but they have a smaller effect on roundabouts than on stop signs or signals.

A substantial part of the delay-reduction benefit of roundabouts, compared to AWSC intersections, comes during off-peak periods.

The planning level analysis that began earlier in this chapter may be extended to estimate the benefits of a roundabout compared to AWSC. Retaining the previous assumptions about the directional and temporal distribution factors for traffic volumes (i.e., $K=0.1$, $D=0.58$), it is possible to analyze both control modes throughout an entire 24-hour day. Only one additional set of assumptions is required. It is necessary to construct an assumed hourly distribution of traffic throughout the day that conforms to these two factors.

A reasonably typical sample distribution for this purpose is illustrated in Exhibit 3-9, which would generally represent inbound traffic to employment centers, because of the larger peak in the AM period, accompanied by smaller peaks in the noontime and PM periods. Daytime off-peak periods have 4 percent of the AADT per hour, and late-night off-peak periods (midnight to 6 AM) have 1 percent.

Exhibit 3-9. Sample hourly distribution of traffic.

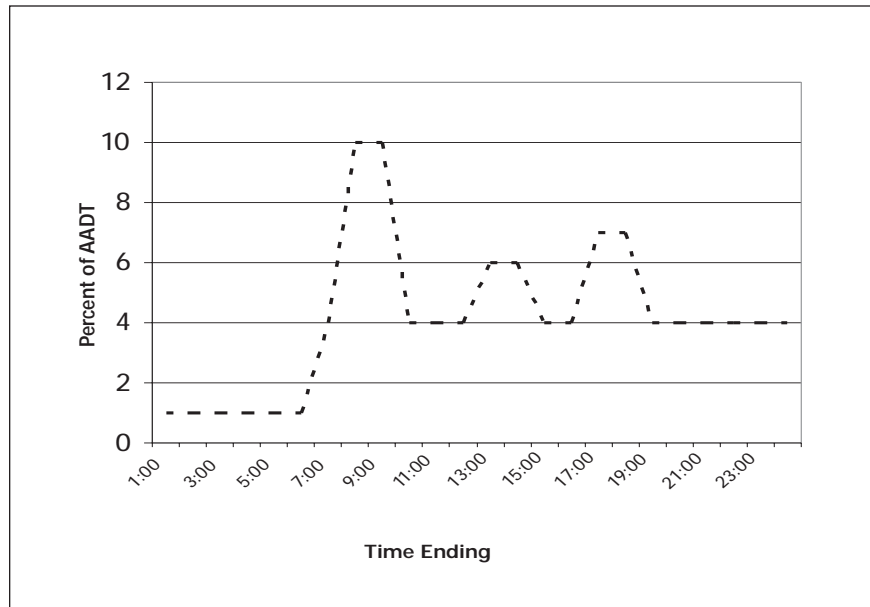

The outbound direction may be added as a mirror image of the inbound direction, keeping the volumes the same as the inbound during the off-peak periods and applying the D factor of 0.58 during the AM and PM peaks. This distribution was used in the estimation of the benefits of a roundabout compared to the AWSC mode. It was also used later for comparison with traffic signal operations. For purposes of estimating annual delay savings, a total of 250 days per year is assumed. This provides a conservative estimate by eliminating weekends and holidays.

The comparisons were performed using traffic operations models that are described in Chapter 4 of this guide. The SIDRA model was used to analyze both the roundabout and AWSC operation, because SIDRA was the only model readily available at the time this guide was developed that treated both of these types of control. SIDRA provides an option to either include or omit the geometric delay experienced within the intersection. The geometric delay was included for purposes of estimating annual benefits. It was excluded in Section 3.4.4.1 that dealt with driver-perceived approach delay.

The results of this comparison are presented in Exhibit 3-10 and Exhibit 3-11 in terms of potential annual savings in delay of a single-lane roundabout over an AWSC intersection with one lane on all approaches, as a function of the proportion of left turning traffic for single-lane approaches for volume distributions of 50 percent and 65 percent on the major street, respectively. Each exhibit has lines representing 10 percent, 25 percent, and 33 percent left turn proportions.

Note that the potential annual benefit is in the range of 5,000 to 50,000 vehicle-hours per year. The benefit increases substantially with increasing AADT and left turn proportions. The comparison terminates in each case when the capacity of the AWSC operation is exceeded. No comparisons were made beyond 18,000 AADT, because AWSC operation is not practical beyond that level.

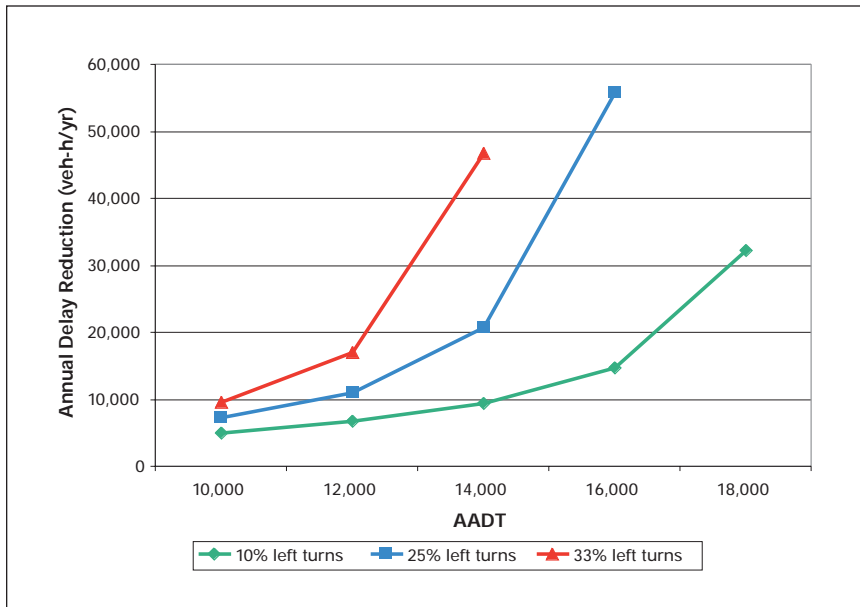

Exhibit 3-10. Annual savings in delay of single-lane roundabout versus AWSC, 50 percent of volume on the major street.

The delay-reduction benefit of roundabouts, compared to AWSC, increases as left-turn volumes, major street proportion, and AADT increase.

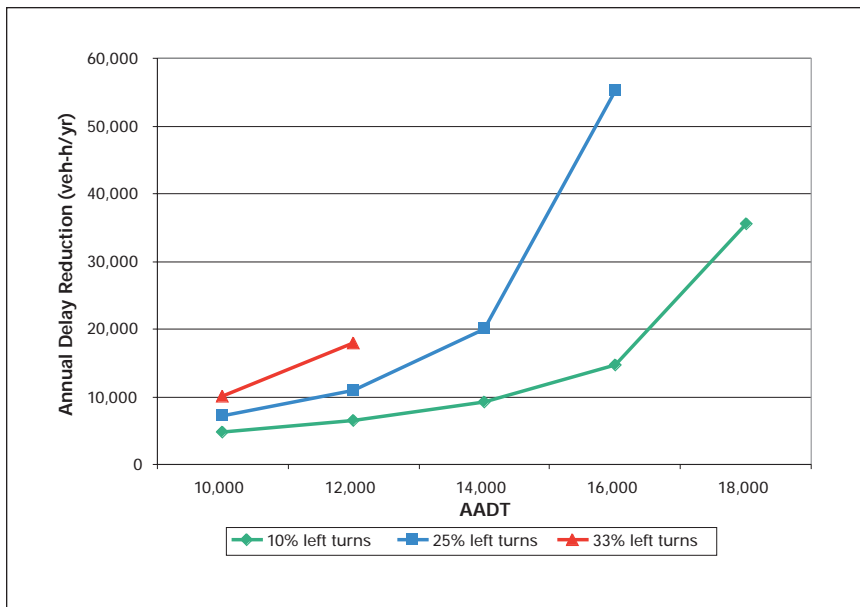

Exhibit 3-11. Annual savings in delay of single-lane roundabout versus AWSC, 65 percent of volume on the major street.

3.5.3 Signal control alternative

When traffic volumes are heavy enough to warrant signalization, the selection process becomes somewhat more rigorous. The usual basis for selection here is that a roundabout will provide better operational performance than a signal in terms of stops, delay, fuel consumption, and pollution emissions. For planning purposes, this may generally be assumed to be the case provided that the roundabout is operating within its capacity. The task then becomes to assess whether any roundabout configuration can be made to work satisfactorily. If not, then a signal or grade separation are remaining alternatives. As in the case of stop control, intersections with heavy left turns are especially good roundabout candidates.

The graphical approximation presented earlier for capacity estimation should be useful at this stage. The results should be considered purely as a planning level estimate, and it must be recognized that this estimate will probably change during the design phase. Users of this guide should also consult the most recent version of the *Highway Capacity Manual* (HCM) (10) as more U.S. data and consensus on modeling U.S. roundabout performance evolves.

As in the case of AWSC operations, some of the most important benefits of a roundabout compared to a traffic signal will accrue during the off-peak periods. The comparison of delay savings discussed previously has therefore been extended to deal with traffic signals as well as stop signs. The same temporal distribution of traffic volumes used for the roundabout-AWSC comparison was assumed.

The signal timing design was prepared for each of the conditions to accommodate traffic in the heaviest peak period. The traffic actuated controller was allowed to respond to fluctuations in demand during the rest of the day using its own logic. This strategy is consistent with common traffic engineering practice. All approaches were considered to be isolated and free of the influence of coordinated systems. Left turn protection was provided for the whole day for all approaches with a volume cross-product (i.e., the product of the left turn and opposing traffic volumes) of 60,000 or greater during the peak period. When left turn protection was provided, the left turns were also allowed to proceed on the solid green indication (i.e., protected-plus-permitted operation).

The results of this comparison are presented in Exhibit 3-12 for 50 percent major street traffic and Exhibit 3-13 for 65 percent major street traffic. Both cases include AADT values up to 34,000 vehicles per day. Single-lane approaches were used for both signals and roundabouts with AADTs below 25,000 vehicles per day. Two-lane approaches were assumed beyond that point. All signalized approaches were assumed to have left turn bays.

Benefits may continue to accrue beyond the 34,000 AADT level but the design parameters for both the signal and the roundabout are much more difficult to generalize for planning level analyses. When AADTs exceed 34,000 vehicles per day, performance evaluation should be carried out using the more detailed procedures presented in Chapter 4 of this guide.

The selection of a roundabout as an alternative to signal control will be much simpler if a single-lane roundabout is estimated to have adequate capacity. If, on the other hand, it is determined that one or more legs will require more than one entry lane, some preliminary design work beyond the normal planning level will generally be required to develop the roundabout configuration and determine the space requirements.

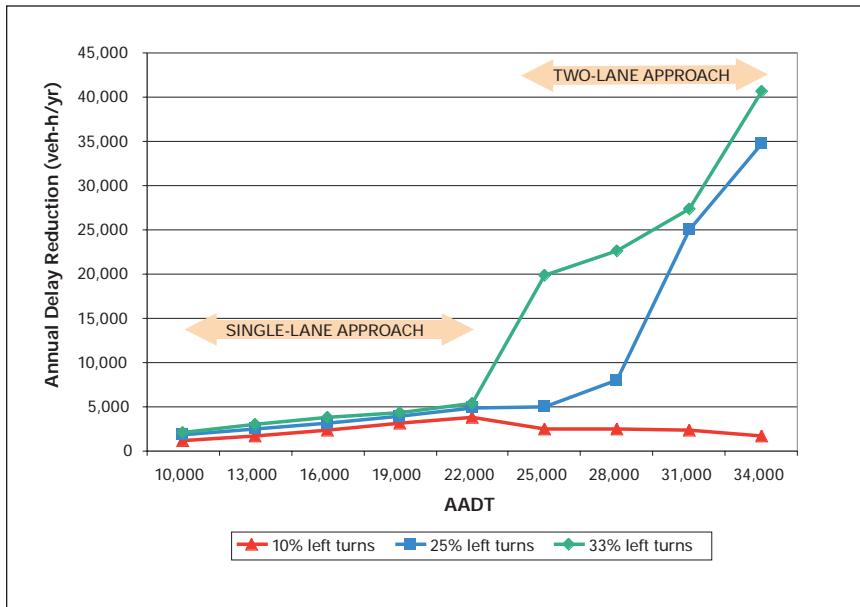

Exhibit 3-12. Delay savings for roundabout vs. signal, 50 percent volume on major street.

When volumes are evenly split between major and minor approaches, the delay savings of roundabouts versus signals are especially notable on two-lane approaches with high left turn proportions.

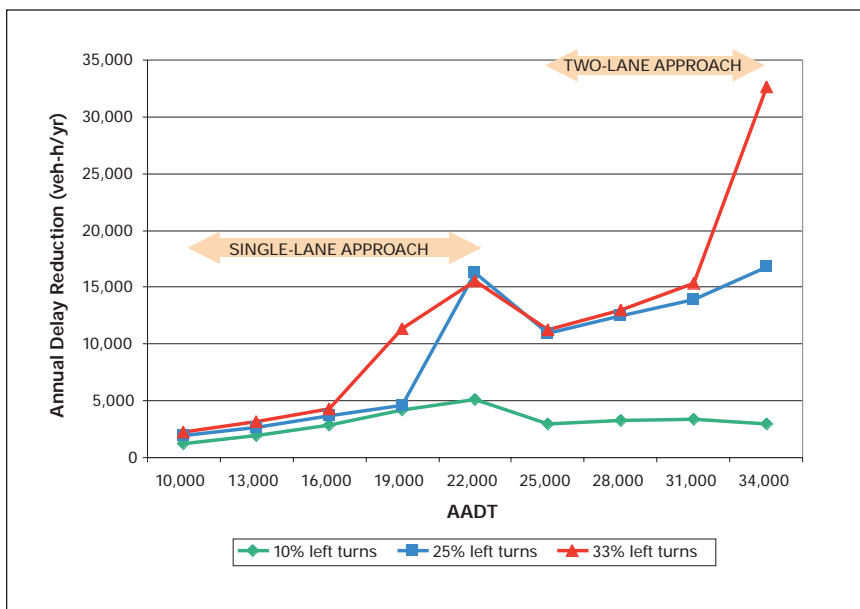

Exhibit 3-13. Delay savings for roundabout vs. signal, 65 percent volume on major street.

When the major street approaches dominate, roundabout delay is lower than signal delay, particularly at the upper volume limit for single-lane approaches and when there is a high proportion of left turns.

3.6 Space Requirements

Roundabouts that are designed to accommodate vehicles larger than passenger cars or small trucks typically require more space than conventional intersections. However, this may be more than offset by the space saved compared with turning lane requirements at alternative intersection forms. The key indicator of the required space is the inscribed circle diameter. A detailed design is required to determine the space requirements at a specific site, especially if more than one lane is needed to accommodate the entering and circulating traffic. This is, however, another case in which the use of assumptions and approximations can produce

The design templates in Appendix B may be used to determine initial space requirements for the appropriate roundabout category.

preliminary values that are adequate for planning purposes. For initial space requirements, the design templates in Appendix B for the most appropriate of the six roundabout categories for the specific site may be consulted.

One important question is whether or not the proposed roundabout will fit within the existing property lines, or whether additional right-of-way will be required. Four examples have been created to demonstrate the spatial effects of comparable intersection types, and the assumptions are summarized in Exhibit 3-14. Note that there are many combinations of turning volumes that would affect the actual lane configurations and design storage lengths. Therefore, these examples should not be used out of context.

Exhibit 3-14. Assumptions for spatial comparison of roundabouts and comparable conventional intersections.

Category	Roundabout Type		Conventional Intersection	
	Main Street Approach Lanes	Side Street Approach Lanes	Main Street Approach Lanes	Side Street Approach Lanes
Urban compact	1	1	1	1
Urban single-lane	1	1	1 + LT pocket	1
Urban double-lane	2	1	2 + LT pocket	1 + LT pocket
Urban double-lane with flaring	1 flared to 2	1	2 + LT pocket	1 + LT pocket

Note: LT = left turn

Although roundabouts typically require more area at the junction compared to conventional intersections, they may not need as much area on the approaches.

As can be seen in Exhibit 3-15 through Exhibit 3-18, roundabouts typically require more area at the junction than conventional intersections. However, as capacity needs increase the size of the roundabout and comparable conventional (signalized) intersection, the increase in space requirements are increasingly offset by a reduction in space requirements on the approaches. This is because the widening or flaring required for a roundabout can be accomplished in a shorter distance than is typically required to develop left turn lanes and transition tapers at conventional intersections.

As can be seen in Exhibit 3-18, flared roundabouts offer the most potential for reducing spatial requirements on the approaches as compared to conventional intersections. This effect of providing capacity at the intersections while reducing lane requirements between intersections, known as “wide nodes and narrow roads,” is discussed further in Chapter 8.

3.7 Economic Evaluation

Economic evaluation is an important part of any public works planning process. For roundabout applications, economic evaluation becomes important when compar-

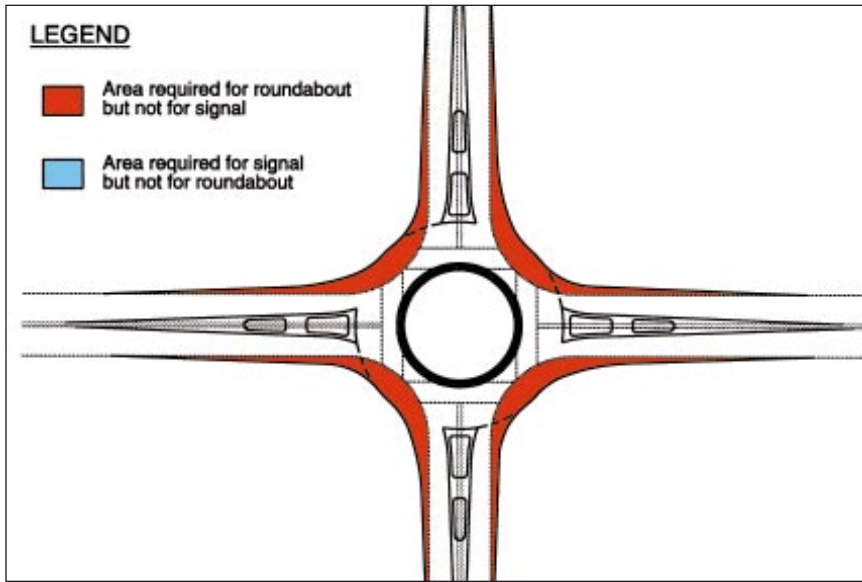

Exhibit 3-15. Area comparison: Urban compact roundabout vs. comparable signalized intersection.

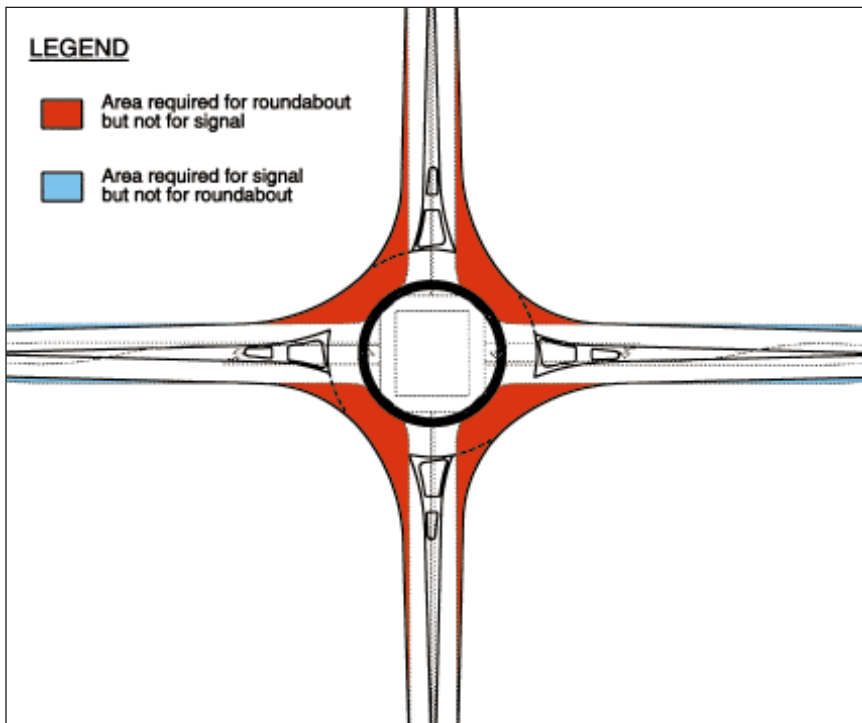

Exhibit 3-16. Area comparison: Urban single-lane roundabout vs. comparable signalized intersection.

Exhibit 3-17. Area comparison:
Urban double-lane roundabout
vs. comparable signalized
intersection.

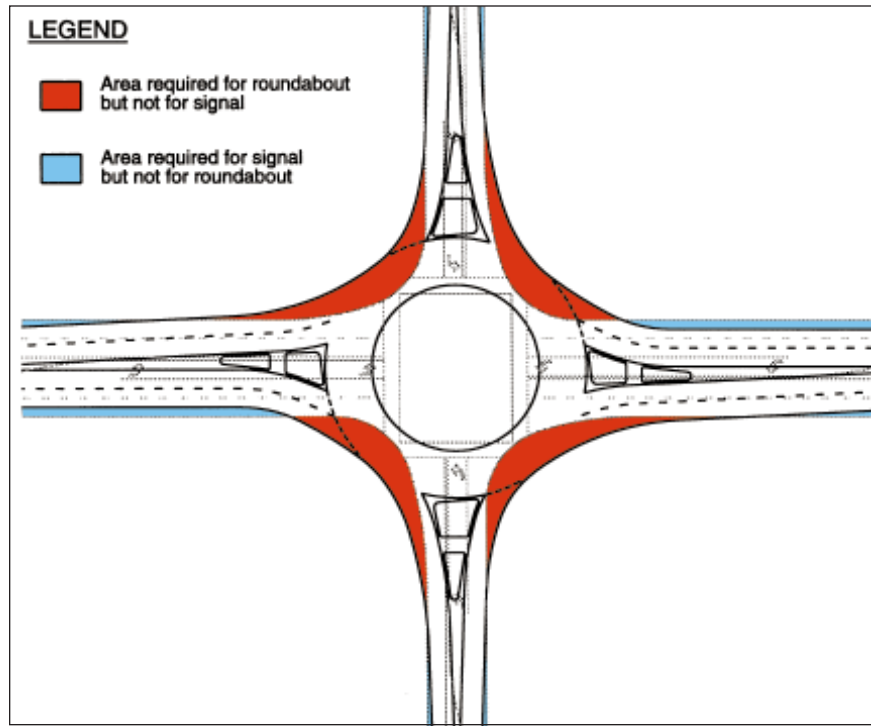
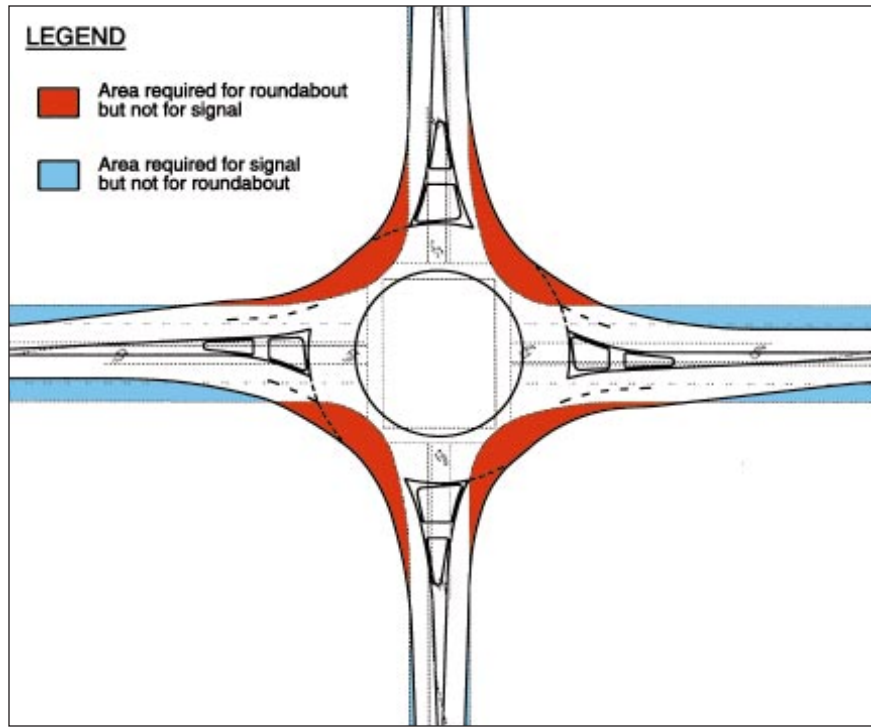

Exhibit 3-18. Area comparison:
Urban flared roundabout vs.
comparable signalized
intersection.



Urban flared roundabouts in particular illustrate the “wide nodes, narrow roads” concept discussed further in Chapter 8.

ing roundabouts against other forms of intersections and traffic control, such as comparing a roundabout with a signalized intersection.

The most appropriate method for evaluating public works projects of this type is usually the benefit-cost analysis method. The following sections discuss this method as it typically applies to roundabout evaluation, although it can be generalized for most transportation projects.

3.7.1 Methodology

The benefit-cost method is elaborated on in detail in a number of standard references, including the ITE *Transportation Planning Handbook* (11) and various American Association of State Highway and Transportation Officials (AASHTO) publications (12, 13). The basic premise of this method of evaluation is to compare the incremental benefit between two alternatives to the incremental costs between the same alternatives. Assuming Alternatives A and B, the equation for calculating the incremental benefit-cost ratio of Alternative B relative to Alternative A is given in Equation 3-1.

$$B/C_{BA} = \frac{Benefits_B - Benefits_A}{Costs_B - Costs_A} \quad (3-1)$$

Benefit-cost analysis typically takes two forms. For assessing the viability of a number of alternatives, each alternative is compared individually with a no-build alternative. If the analysis for Alternative A relative to the no-build alternative indicates a benefit-cost ratio exceeding 1.0, Alternative A has benefits that exceed its costs and is thus a viable project.

For ranking alternatives, the incremental benefit-cost ratio analysis is used to compare the relative benefits and costs between alternatives. Projects should not be ranked based on their benefit-cost ratio relative to the no-build alternative. After eliminating any alternatives that are not viable as compared to the no-build alternative, alternatives are compared in a pair-wise fashion to establish the priority between projects.

Since many of the input parameters may be estimated, a rigorous analysis should consider varying the parameter values of key assumptions to verify that the recommended alternative is robust, even under slightly varying assumptions, and under what circumstances it may no longer be preferred.

3.7.2 Estimating benefits

Benefits for a public works project are generally comprised of three elements: safety benefits, operational benefits, and environmental benefits. Each benefit is typically quantified on an annualized basis and so is readily usable in a benefit-cost analysis. The following sections discuss these in more detail.

Rank alternatives based on their incremental benefit-cost ratio, not on their ratio relative to the no-build alternative.

Benefits consist of:

- **Safety benefits**
- **Operational benefits**
- **Environmental benefits**

3.7.2.1 Safety benefits

Safety benefits are defined as the assumed savings to the public due to a reduction in crashes within the project area. The general procedure for determining safety benefits is as follows:

- Quantify the existing safety history in the study area in terms of a crash rate for each level of severity (fatal, injury, property damage). This rate, expressed in terms of crashes per million entering vehicles, is computed by dividing the number of crashes of a given severity that occurred during the “before” period by the number of vehicles that entered the intersection during the same period. This results in a “before” crash rate for each level of severity.
- Estimate the change in crashes of each level of severity that can be reasonably expected due to the proposed improvements. As documented elsewhere in this guide, roundabouts tend to have proportionately greater reductions in fatal and injury crashes than property damage crashes.
- Determine a new expected crash rate (an “after” crash rate) by multiplying the “before” crash rates by the expected reductions. It is best to use local data to determine appropriate crash reduction factors due to geometric or traffic control changes, as well as the assumed costs of various severity levels of crashes.
- Estimate the number of “after” crashes of each level of severity for the life of the project by multiplying the “after” crash rate by the expected number of entering vehicles over the life of the project.
- Estimate a safety benefit by multiplying the expected number of “after” crashes of each level of severity by the average cost of each crash and then annualizing the result. The values in Exhibit 3-19 can provide a starting point, although local data should be used where available.

Exhibit 3-19. Estimated costs for crashes of varying levels of severity.

Crash Severity	Economic Cost (1997 dollars)
Death (per death)	\$980,000
Injury (per injury)	\$34,100
Property Damage Only (per crash)	\$6,400

Source: National Safety Council (14)

3.7.2.2 Operational benefits

Quantify operational benefits in terms of vehicle-hours of delay.

The operational benefits of a project may be quantified in terms of the overall reduction in person-hours of delay to the public. Delay has a cost to the public in terms of lost productivity, and thus a value of time can typically be assigned to changes in estimated delay to quantify benefits associated with delay reduction.

The calculation of annual person-hours of delay can be performed with varying levels of detail, depending on the availability of data. For example, the vehicle-hours of delay may be computed as follows. The results should be converted to person-hours of delay using appropriate vehicle-occupancy factors (including transit), then adding pedestrian delay if significant.

- Estimate the delay per vehicle for each hour of the day. If turning movements are available for multiple hours, this estimate can be computed directly. If only the peak hour is available, the delay for an off-peak hour can be approximated by proportioning the peak hour turning movements by total entering vehicles.
- Determine the daily vehicle-hours of delay by multiplying the estimated delay per vehicle for a given hour by the total entering vehicles during that hour and then aggregating the results over the entire day. If data is available, these calculations can be separated by day of week or by weekday, Saturday, and Sunday.
- Determine annual vehicle-hours of delay by multiplying the daily vehicle-hours of delay by 365. If separate values have been calculated by day of week, first determine the weekday vehicle-hours of delay and then multiply by 52.1 (365 divided by 7). It may be appropriate to use fewer than 365 days per year because the operational benefits will not usually apply equally on all days.

3.7.2.3 Environmental benefits

The environmental benefits of a project are most readily quantified in terms of reduced fuel consumption and improved air quality. Of these, reductions in fuel consumption and the benefits associated with those reductions are typically the simplest to determine.

One way to determine fuel consumption is to use the same procedure for estimating delay, as described previously. Fuel consumption is an output of several of the models in use today, although the user is cautioned to ensure that the model is appropriately calibrated for current U.S. conditions. Alternatively, one can estimate fuel consumption by using the estimate of annual vehicle-hours of delay and then multiplying that by an assumed fuel consumption rate during idling, expressed as liters per hour (gallons per hour) of idling. The resulting estimate can then be converted to a cost by assuming an average cost of fuel, expressed in dollars per liter (dollars per gallon).

3.7.3 Estimation of costs

Costs for a public works project are generally comprised of two elements: capitalized construction costs and operations and maintenance (O&M) costs. Although O&M costs are typically determined on an annualized basis, construction costs are typically a near-term activity that must be annualized. The following sections discuss these in more detail.

3.7.3.1 Construction costs

Construction costs for each alternative should be calculated using normal preliminary engineering cost estimating techniques. These costs should include the costs of any necessary earthwork, paving, bridges and retaining walls, signing and striping, illumination, and signalization.

To convert construction costs into an annualized value for use in the benefit-cost analysis, a *capital recovery factor* (CRF) should be used, shown in Equation 3-2. This converts a present value cost into an annualized cost over a period of n years using an assumed discount rate of i percent.

$$CRF = \frac{i(1 + i)^n}{i(1 + i)^n - 1} \quad (3-2)$$

where: i = discount rate
 n = number of periods (years)

3.7.3.2 Operation and maintenance (O&M) costs

Operation and maintenance costs vary significantly between roundabouts and other forms of intersection control beyond the basic elements. Common elements include signing and pavement marking maintenance and power for illumination, if provided.

Roundabout O&M costs are typically slightly higher than signalized intersections for:

- Illumination
 - Signing
- Pavement marking
 - Landscaping

Roundabouts typically have a slightly higher illumination power and maintenance costs compared to signalized or sign-controlled intersections due to a larger number of illumination poles. Roundabouts have slightly higher signing and pavement marking maintenance costs due to a higher number of signs and pavement markings. Roundabouts also introduce additional cost associated with the maintenance of any landscaping in and around the roundabout.

Signalized intersections also have O&M costs for:

- Signal power
- Bulb replacement
- Detection maintenance

Signalized intersections have considerable additional cost associated with power for the traffic signal and maintenance costs such as bulb replacement, detection maintenance, etc. Power costs vary considerably from region to region and over time and should be verified locally. For general purposes, an annual cost of \$3,000 for providing power to a signalized intersection is a reasonable approximation.

3.8 References

1. Austroads. *Guide to Traffic Engineering Practice, Part 6—Roundabouts*. Sydney, Australia: Austroads, 1993.
2. Brilon, W., N. Wu, and L. Bondzio. "Unsignalized Intersections in Germany—A State of the Art 1997." In *Proceedings of the Third International Symposium on Intersections without Traffic Signals* (ed: M. Kyte), Portland, Oregon, U.S.A. University of Idaho, 1997.
3. Maycock, G., and R.D. Hall. *Crashes at four-arm roundabouts*. TRRL Laboratory Report LR 1120. Crowthorne, England: Transport and Road Research Laboratory, 1984.
4. Vogt, A. *Crash Models for Rural Intersections: 4-Lane by 2-Lane Stop-Controlled and 2-Lane by 2-Lane Signalized*. Washington, D.C.: Federal Highway Administration, 1999.
5. Bauer, K.M., and D.W. Harwood. *Statistical Models of At-Grade Intersection Crashes*. Report No. FHWA-RD-99-094. Washington, D.C.: Federal Highway Administration, 1999.

6. Bared, J.G., and K. Kennedy. "Safety Impacts of Roundabouts," Chapter 28, *The Traffic Safety Toolbox: A Primer on Traffic Safety*, Institute of Transportation Engineers, 2000.
7. Florida Department of Transportation. Florida Roundabout Guide. Florida Department of Transportation, March 1996.
8. Federal Highway Administration (FHWA). *Manual on Uniform Traffic Control Devices*. Washington, D.C.: FHWA, 1988.
9. Akçelik, R., and M. Besley. *SIDRA 5 User Guide*. Melbourne, Australia: Australian Road Research Board, January 1999.
10. Transportation Research Board. *Highway Capacity Manual*. Special Report 209. Washington, D.C.: Transportation Research Board, National Research Council, July 1999 (draft).
11. Institute of Transportation Engineers. *Transportation Planning Handbook* (J. Edwards, Jr., ed.). Englewood Cliffs, N.J.: Prentice Hall, 1992.
12. American Association of State Highway Officials (AASHO). *A Policy on Design of Urban Highways and Arterial Streets*. Washington, D.C.: AASHO, 1973.
13. American Association of State Highway & Transportation Officials (AASHTO). *A Manual on User Benefit Analysis of Highway and Bus Transit Improvements*. Washington, D.C.: AASHTO, 1977.
14. National Safety Council. *Accident Facts*, 1998 Edition.

4

Operation

4.1	Traffic Operation at Roundabouts	82
4.1.1	Driver behavior and geometric elements	82
4.1.2	Concept of roundabout capacity	83
4.2	Data Requirements	83
4.3	Capacity	86
4.3.1	Single-lane roundabout capacity	86
4.3.2	Double-lane roundabout capacity	88
4.3.3	Capacity effect of short lanes at flared entries	88
4.3.4	Comparison of single-lane and double-lane roundabouts	89
4.3.5	Pedestrian effects on entry capacity	90
4.3.6	Exit capacity	91
4.4	Performance Analysis	91
4.4.1	Degree of saturation	92
4.4.2	Delay	92
4.4.3	Queue length	94
4.4.4	Field observations	96
4.5	Computer Software for Roundabouts	96
4.6	References	98
Exhibit 4-1.	Conversion factors for passenger car equivalents (pce).	84
Exhibit 4-2.	Traffic flow parameters.	85
Exhibit 4-3.	Approach capacity of a single-lane roundabout.	87
Exhibit 4-4.	Approach capacity of a double-lane roundabout.	88

Exhibit 4-5.	Capacity reduction factors for short lanes.	89
Exhibit 4-6.	Capacity comparison of single-lane and double-lane roundabouts.	89
Exhibit 4-7.	Capacity reduction factor M for a single-lane roundabout assuming pedestrian priority.	90
Exhibit 4-8.	Capacity reduction factor M for a double-lane roundabout assuming pedestrian priority.	91
Exhibit 4-9.	Control delay as a function of capacity and entering flow.	93
Exhibit 4-10.	95th-percentile queue length estimation.	95
Exhibit 4-11.	Summary of roundabout software products for operational analysis.	97

Chapter 4 Operation

This chapter presents methods for analyzing the operation of an existing or planned roundabout. The methods allow a transportation analyst to assess the operational performance of a facility, given information about the usage of the facility and its geometric design elements. An operational analysis produces two kinds of estimates: (1) the capacity of a facility, i.e., the ability of the facility to accommodate various streams of users, and (2) the level of performance, often measured in terms of one or more measures of effectiveness, such as delay and queues.

The *Highway Capacity Manual* (1) (HCM) defines the *capacity* of a facility as “the maximum hourly rate at which persons or vehicles can reasonably be expected to traverse a point or uniform section of a lane or roadway during a given time period under prevailing roadway, traffic, and control conditions.” While capacity is a specific measure that can be defined and estimated, *level of service* (LOS) is a qualitative measure that “characterizes operational conditions within a traffic stream and their perception by motorists and passengers.” To quantify level of service, the HCM defines specific *measures of effectiveness* for each highway facility type. *Control delay* is the measure of effectiveness that is used to define level of service at intersections, as perceived by users. In addition to control delay, all intersections cause some drivers to also incur *geometric delays* when making turns. A systems analysis of a roadway network may include geometric delay because of the slower vehicle paths required for turning through intersections. An example speed profile is shown in Chapter 6 to demonstrate the speed reduction that results from geometric delay at a roundabout.

Roundabouts produce both control delay and geometric delay.

While an operational analysis can be used to evaluate the performance of an existing roundabout during a base or future year, its more common function in the U.S. may be to evaluate new roundabout designs.

This chapter:

- Describes traffic operations at roundabouts;
- Lists the data required to evaluate the performance of a roundabout;
- Presents a method to estimate the capacity of five of the six basic roundabout configurations presented in this guide;
- Describes the measures of effectiveness used to determine the performance of a roundabout and a method to estimate these measures; and
- Briefly describes the computer software packages available to implement the capacity and performance analysis procedures.

Appendix A provides background information on the various capacity relationships.

4.1 Traffic Operation at Roundabouts

4.1.1 Driver behavior and geometric elements

A roundabout brings together conflicting traffic streams, allows the streams to safely merge and traverse the roundabout, and exit the streams to their desired directions. The geometric elements of the roundabout provide guidance to drivers approaching, entering, and traveling through a roundabout.

Drivers approaching a roundabout must slow to a speed that will allow them to safely interact with other users of the roundabout, and to negotiate the roundabout. The width of the approach roadway, the curvature of the roadway, and the volume of traffic present on the approach govern this speed. As drivers approach the yield line, they must check for conflicting vehicles already on the circulating roadway and determine when it is safe and prudent to enter the circulating stream. The widths of the approach roadway and entry determine the number of vehicle streams that may form side by side at the yield line and govern the rate at which vehicles may enter the circulating roadway. The size of the inscribed circle affects the radius of the driver's path, which in turn determines the speed at which drivers travel on the roundabout. The width of the circulatory roadway determines the number of vehicles that may travel side by side on the roundabout.

Approach speed is governed by:

- **Approach roadway width**
- **Roadway curvature**
- **Approach volume**

The British (2), French (3), and German (4) analytical procedures are based on empirical relationships that directly relate capacity to both traffic characteristics and roundabout geometry. The British empirical relationships reveal that small sublane changes in the geometric parameters produce significant changes in capacity.

For instance, if some approaches are flared or have additional short lanes, these provide considerably more capacity for two reasons. First, wider entries require wider circulatory roadway widths. This provides for more opportunities for the circulatory traffic to bunch together, thus increasing the number of acceptable opportunities to enter, thereby increasing capacity. Second, the typical size of groups of drivers entering into acceptable opportunities in the circulatory traffic is quite small, so short lanes can be very effective in increasing group sizes, because the short lane is frequently able to be filled.

The British (2) use the inscribed circle diameter, the entry width, the approach (road) half width, the entry radius, and the sharpness of the flare to define the performance of a roundabout. The sharpness of the flare, S , is a measure of the rate at which the extra width is developed in the entry flare. Large values of S correspond to short, severe flares, and small values of S correspond to long, gradual flares (5).

Geometric elements that affect entry capacity include:

- **Approach half width**
 - **Entry width**
 - **Entry angle**
- **Average effective flare length**

The results of the extensive empirical British research indicate that approach half width, entry width, average effective flare length and entry angle have the most significant effect on entry capacity. Roundabouts fit into two general classes: those with a small inscribed circle diameter of less than 50 m (165 ft.) and those with a diameter above 50 m. The British relationships provide a means of including both of these roundabout types. The inscribed circle diameter has a relatively small effect for inscribed diameters of 50 m (165 ft) or less. The entry radius has little effect on capacity provided that it is 20 m (65 ft) or more. The use of perpendicular entries (70

degrees or more) and small entry radii (less than 15 m [50 ft]) will reduce capacity. The presence of the geometric parameters in the British and French models allow designers to manipulate elements of their design to determine both their operational and safety effects. German research has not been able to find the same influence of geometry, although this may be due to the relatively narrow range of geometries in Germany (4).

Thus, the geometric elements of a roundabout, together with the volume of traffic desiring to use a roundabout at a given time, may determine the efficiency with which a roundabout operates.

4.1.2 Concept of roundabout capacity

The capacity of each entry to a roundabout is the maximum rate at which vehicles can reasonably be expected to enter the roundabout from an approach during a given time period under prevailing traffic and roadway (geometric) conditions. An operational analysis considers a precise set of geometric conditions and traffic flow rates defined for a 15-minute analysis period for each roundabout entry. While consideration of Average Annual Daily Traffic volumes (AADT) across all approaches is useful for planning purposes as provided in Exhibit 1-13 and Chapter 3, analysis of this shorter time period is critical to assessing the level of performance of the roundabout and its individual components.

The capacity of the entire roundabout is not considered, as it depends on many terms. However, Exhibit 1-13 provides threshold average daily traffic volumes for the various categories of roundabouts, assuming four legs. Below these thresholds, a four-legged roundabout with roadways intersecting perpendicularly should have adequate capacity (provided the traffic volumes are reasonably balanced and the geometry does not deviate substantially from those shown on the design templates in Exhibits 1-7 through 1-12). The focus in this chapter on the roundabout entry is similar to the operational analysis methods used for other forms of unsignalized intersections and for signalized intersections. In each case, the capacity of the entry or approach is computed as a function of traffic on the other (conflicting) approaches, the interaction of these traffic streams, and the intersection geometry.

For a properly designed roundabout, the yield line is the relevant point for capacity analysis. The approach capacity is the capacity provided at the yield line. This is determined by a number of geometric parameters in addition to the entry width. On multilane roundabouts it is important to balance the use of each lane, because otherwise some lanes may be overloaded while others are underused. Poorly designed exits may influence driver behavior and cause lane imbalance and congestion at the opposite leg.

4.2 Data Requirements

The analysis method described in this chapter requires the specification of traffic volumes for each approach to the roundabout, including the flow rate for each directional movement. Volumes are typically expressed in passenger car vehicles per hour (vph), for a specified 15-minute analysis period. To convert other vehicle types to *passenger car equivalents* (pce), use the conversion factors given in Exhibit 4-1.

Perpendicular entries and small entry radii reduce capacity; inscribed circle diameters of 50 m (165 ft) or less have little effect on capacity.

Roundabout capacity defined.

Operational analyses consider 15-minute volumes, as opposed to the daily volumes used in planning analyses.

The approach capacity is the capacity provided at the yield line.

Different size vehicles have different capacity impacts; passenger cars are used as the basis for comparison.

Exhibit 4-1. Conversion factors for passenger car equivalents (pce).

Vehicle Type	Passenger Car Equivalent (pce)
Car	1.0
Single-unit truck or bus	1.5
Truck with trailer	2.0
Bicycle or motorcycle	0.5

Source: (6), (7)

Traffic volume data for an urban roundabout should be collected for each directional movement for at least the morning and evening peak periods, since the various movements, and thus approach and circulating volumes, may peak at different times. At rural roundabouts, the analyst should check the requirements of the agency with the jurisdiction of the site. The reader is referred to the *Manual of Transportation Engineering Studies* (8) for a complete discussion of traffic volume data collection methods. Typically, intersection volume counts are made at the intersection stop bar, with an observer noting the number of cars that pass that point over a specified time period. However, particularly with respect to cases in which demand exceeds capacity (when queues do not dissipate within the analysis period), it is important to note that the stop bar counts reflect only the volume that is served, not the demand volume. In this case, care must be taken to collect data upstream of the end of a queue so that true demand volumes are available for analysis.

Entry flow and circulating flow for each approach are the volumes of interest for roundabout capacity analysis, rather than turning movement volumes.

The relationship between the standard origin-to-destination turning movements at an intersection and the circulating and entry flows at a roundabout is important, yet is often complicated to compute, particularly if an intersection has more than four approaches. For conventional intersections, traffic flow data are accumulated by directional turning movement, such as for the northbound left turn. For roundabouts, however, the data of interest for each approach are the entry flow and the circulating flow. Entry flow is simply the sum of the through, left, and right turn movements on an approach. Circulating flow is the sum of the vehicles from different movements passing in front of the adjacent upstream splitter island. At existing roundabouts, these flows can simply be measured in the field. Right turns are included in approach volumes and require capacity, but are not included in the circulating volumes downstream because they exit before the next entrance.

For proposed or planned four-legged roundabouts, Equations 4-1 through 4-4 can be applied to determine conflicting (circulating) flow rates, as shown graphically in Exhibit 4-2.

Determining circulating volumes as a function of turning movement volumes.

$$V_{EB,circ} = V_{WB,LT} + V_{SB,LT} + V_{SB,TH} + V_{NB,U-turn} + V_{WB,U-turn} + V_{SB,U-turn} \quad (4-1)$$

$$V_{WB,circ} = V_{EB,LT} + V_{NB,LT} + V_{NB,TH} + V_{SB,U-turn} + V_{EB,U-turn} + V_{NB,U-turn} \quad (4-2)$$

$$V_{NB,circ} = V_{EB,LT} + V_{EB,TH} + V_{SB,LT} + V_{WB,U-turn} + V_{SB,U-turn} + V_{EB,U-turn} \quad (4-3)$$

$$V_{SB,circ} = V_{WB,LT} + V_{WB,TH} + V_{NB,LT} + V_{EB,U-turn} + V_{NB,U-turn} + V_{WB,U-turn} \quad (4-4)$$

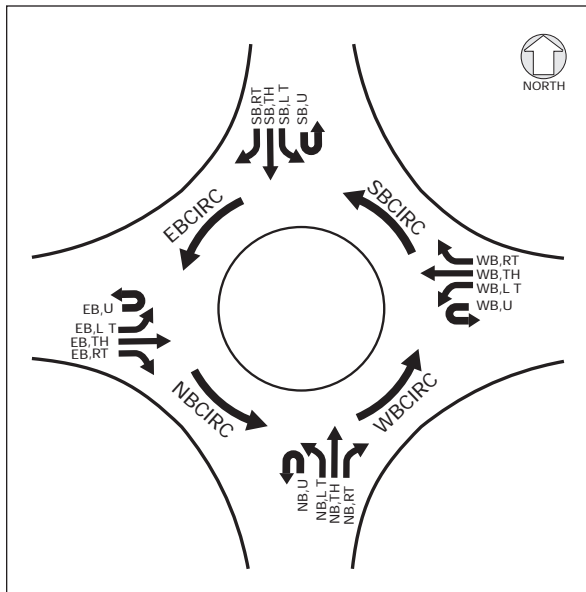

Exhibit 4-2. Traffic flow parameters.

For existing roundabouts, when approach, right-turn, circulating, and exit flows are counted, directional turning movements can be computed as shown in the following example. Equation 4-5 shows the through movement flow rate for the eastbound approach as a function of the entry flow rate for that approach, the exit flow rate for the opposing approach, the right turn flow rate for the subject approach, the right turn flow rate for the approach on the right, and the circulating flow rate for the approach on the right. Other through movement flow rates can be estimated using a similar relationship.

$$V_{EB,TH} = V_{EB,entry} + V_{WB,exit} - V_{EB,RT} - V_{NB,RT} - V_{NB,circ} \quad (4-5)$$

The left turn flow rate for an approach is a function of the entry flow rate, the through flow rate, and the right turn flow rate for that same approach, as shown in Equation 4-6. Again, other movements' flows are estimated using similar equations.

$$V_{EB,LT} = V_{EB,entry} - V_{EB,TH} - V_{EB,RT} \quad (4-6)$$

While this method is mathematically correct, it is somewhat sensitive to errors and inconsistencies in the input data. It is important that the counts at all of the locations in the roundabout be made simultaneously. Inconsistencies in the data from counts taken on different days can produce meaningless results, including negative volumes. At a minimum, the sum of the entering and exiting volumes should be checked and adjustments should be made if necessary to ensure that the same amount of traffic enters and leaves the roundabout.

Roundabout approach capacity is dependent on the conflicting circulating flow and the roundabout's geometric elements.

Roundabouts should be designed to operate at no more than 85 percent of their estimated capacity. Beyond this threshold, delays and queues vary significantly from their mean values.

4.3 Capacity

The maximum flow rate that can be accommodated at a roundabout entry depends on two factors: the circulating flow on the roundabout that conflicts with the entry flow, and the geometric elements of the roundabout.

When the circulating flow is low, drivers at the entry are able to enter the roundabout without significant delay. The larger gaps in the circulating flow are more useful to the entering drivers and more than one vehicle may enter each gap. As the circulating flow increases, the size of the gaps in the circulating flow decrease, and the rate at which vehicles can enter also decreases. Note that when computing the capacity of a particular leg, the actual circulating flow to use may be less than demand flows, if the entry capacity of one leg contributing to the circulating flow is less than demand on that leg.

The geometric elements of the roundabout also affect the rate of entry flow. The most important geometric element is the width of the entry and circulatory roadways, or the number of lanes at the entry and on the roundabout. Two entry lanes permit nearly twice the rate of entry flow as does one lane. Wider circulatory roadways allow vehicles to travel alongside, or follow, each other in tighter bunches and so provide longer gaps between bunches of vehicles. The flare length also affects the capacity. The inscribed circle diameter and the entry angle have minor effects on capacity.

As at other forms of unsignalized intersection, when traffic flows on an approach exceed approximately 85 percent of capacity, delays and queue lengths vary significantly about their mean values (with standard deviations of similar magnitude as the means). For this reason, the analysis procedures in some countries (Australia, Germany, and the United Kingdom), and this guide, recommend that roundabouts be designed to operate at no more than 85 percent of their estimated capacity.

As performance data become available for roundabouts designed according to the procedures in this guide in the United States, they will provide a basis for development of operational performance procedures specifically calibrated for U.S. conditions. Therefore, analysts should consult future editions of the *Highway Capacity Manual*.

4.3.1 Single-lane roundabout capacity

Exhibit 4-3 shows the expected capacity for a single-lane roundabout for both the urban compact and urban/rural single-lane designs. The exhibit shows the variation of maximum entry flow as a function of the circulating flow on the roundabout. The calculation of the circulating flow was described previously. The capacity forecast shown in the chart is valid for single-lane roundabouts with inscribed circle diameters of 25 m to 55 m (80 ft to 180 ft). The capacity forecast is based on simplified British regression relationships in Appendix A, which may also be derived with a gap-acceptance model by incorporating limited priority behavior.

Note that in any case, the flow rate downstream of the merge point (between the entry and the next exit) should not be allowed to exceed 1,800 veh/h. Exceeding this threshold may indicate the need for a double-lane entry.

The urban compact design is expected to have a reduced capacity, but has significant benefits of reduced vehicle speeds through the roundabout (per the German equations in Appendix A). This increases safety for pedestrians and bicyclists compared with the larger single lane roundabouts. Mini-roundabout capacities may be approximated using the daily maximum service volumes provided for them in Chapter 3, but in any case should not exceed the capacity of the urban compact design.

Circulating flow should not exceed 1,800 veh/h at any point in a single-lane roundabout. Exit flows exceeding 1,200 veh/h may indicate the need for a double-lane exit.

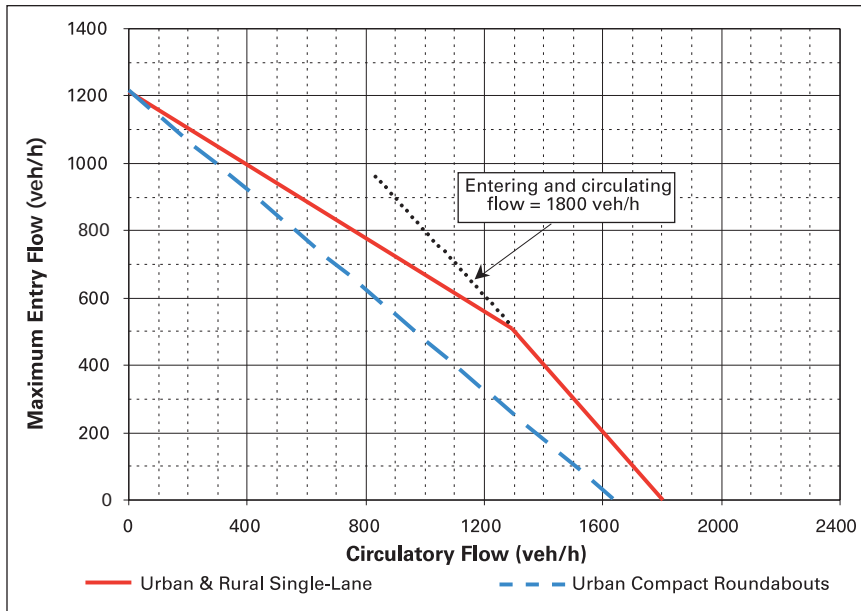

Exhibit 4-3. Approach capacity of a single-lane roundabout.

The slope of the upper line changes because circulating flow downstream from a roundabout entry should not exceed 1,800 veh/h.

4.3.2 Double-lane roundabout capacity

Exhibit 4-4 shows the expected capacity of a double-lane roundabout that is based on the design templates for the urban/rural double-lane roundabouts. The capacity forecast shown in the chart is valid for double-lane roundabouts with inscribed circle diameters of 40 m to 60 m (130 ft to 200 ft). The capacity forecast is based on simplified British regression relationships in Appendix A, which may also be derived with a gap-acceptance model by incorporating limited priority behavior. Larger inscribed diameter roundabouts are expected to have slightly higher capacities at moderate to high circulating flows.

Exhibit 4-4. Approach capacity of a double-lane roundabout.

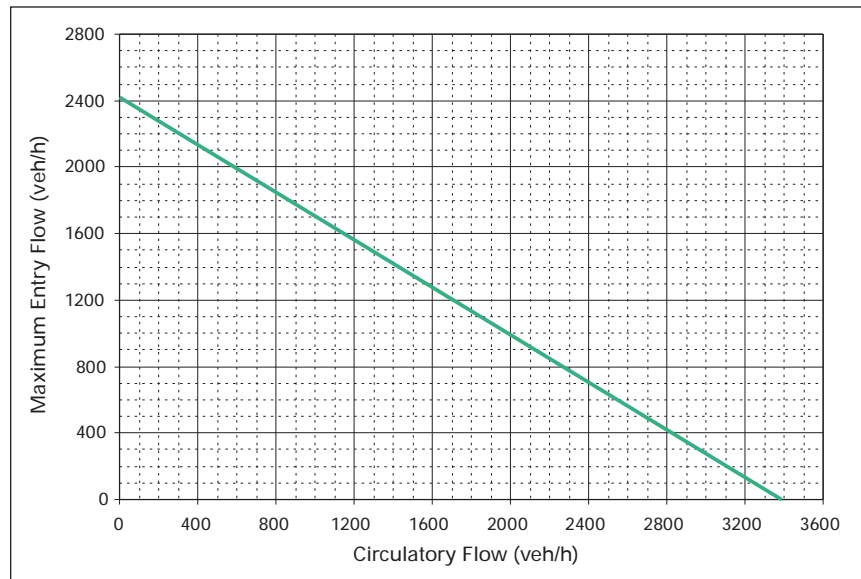

When flared approaches are used, the circulatory road width must be widened.

See Appendix A for further information on the effects of short lanes at flared entries.

4.3.3 Capacity effect of short lanes at flared entries

By flaring an approach, short lanes may be added at the entry to improve the performance. If an additional short lane is used, it is assumed that the circulatory road width is also increased accordingly. The capacity of the entry is based on the assumption that all entry lanes will be effectively used. The capacity is given by the product of the appropriate factor in Exhibit 4-5 and the capacity of a two-lane roundabout in Exhibit 4-4. Refer to Appendix A for a derivation of these factors (9).

Number of vehicle spaces in the short lane, n_s	Factor (applied to double-lane approach capacity)
0 *	0.500
1	0.707
2	0.794
4	0.871
6	0.906
8	0.926
10	0.939

*Used for the case of a single lane entry to a double-lane roundabout.

4.3.4 Comparison of single-lane and double-lane roundabouts

Exhibit 4-6 shows a comparison of the expected capacity for both the single-lane and double-lane roundabouts. Again, it is evident that the number of lanes, or the size of the entry and circulating roadways, has a significant effect on the entry capacity.

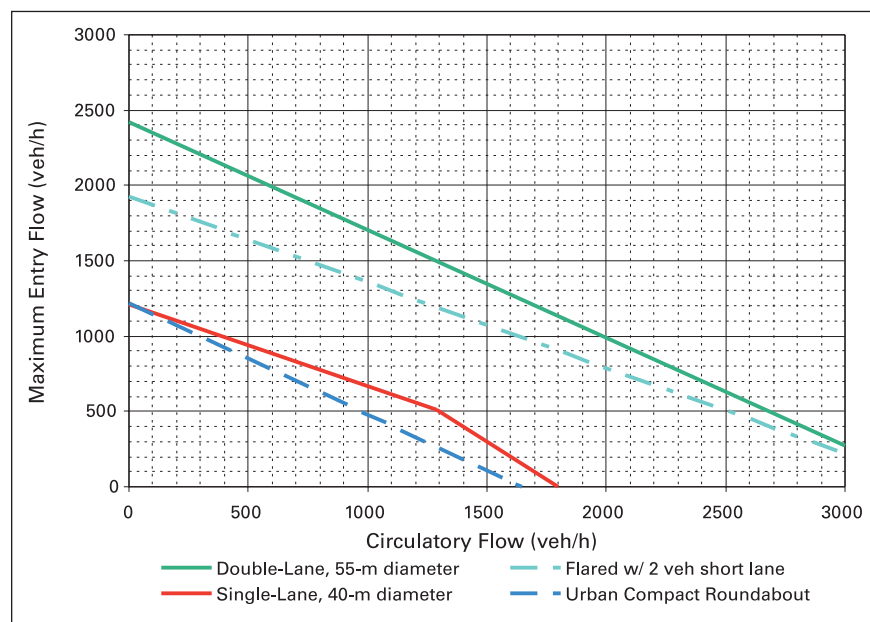

Source (10)

Exhibit 4-5. Capacity reduction factors for short lanes.

The use of short lanes can nearly double approach capacity, without requiring a two-lane roadway prior to the roundabout.

Exhibit 4-6. Capacity comparison of single-lane and double-lane roundabouts.

4.3.5 Pedestrian effects on entry capacity

Pedestrians crossing at a marked crosswalk that gives them priority over entering motor vehicles can have a significant effect on the entry capacity. In such cases, if the pedestrian crossing volume and circulating volume are known, the vehicular capacity should be factored (multiply by M) according to the relationship shown in Exhibit 4-7 or Exhibit 4-8 for single-lane and double-lane roundabouts, respectively. Note that the pedestrian impedance decreases as the conflicting vehicle flow increases. The *Highway Capacity Manual* (1) provides additional guidance on the capacity of pedestrian crossings and should be consulted if the capacity of the crosswalk itself is an issue.

Exhibit 4-7. Capacity reduction factor M for a single-lane roundabout assuming pedestrian priority.

The effects of conflicting pedestrians on approach capacity decrease as conflicting vehicular volumes increase, as entering vehicles become more likely to have to stop regardless of whether pedestrians are present.

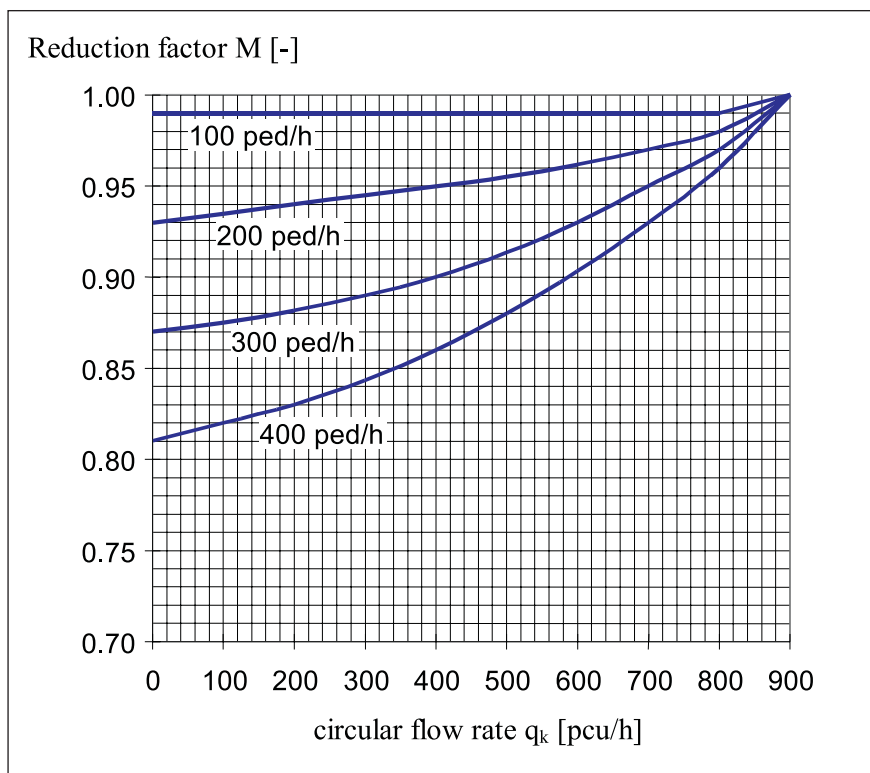

Source: (10)

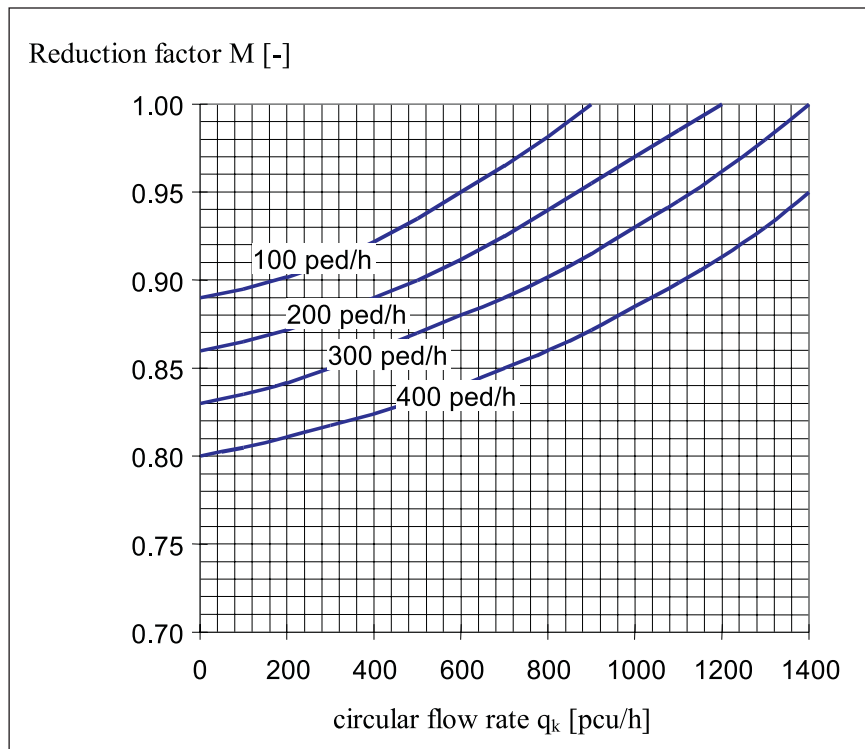

Exhibit 4-8. Capacity reduction factor M for a double-lane roundabout assuming pedestrian priority.

Source: (10)

4.3.6 Exit capacity

An exit flow on a single lane of more than 1,400 veh/h, even under good operating conditions for vehicles (i.e., tangential alignment, and no pedestrians and bicyclists) is difficult to achieve. Under normal urban conditions, the exit lane capacity is in the range of 1,200 to 1,300 veh/h. Therefore, exit flows exceeding 1,200 veh/h may indicate the need for a double-lane exit (11).

4.4 Performance Analysis

Three performance measures are typically used to estimate the performance of a given roundabout design: degree of saturation, delay, and queue length. Each measure provides a unique perspective on the quality of service at which a roundabout will perform under a given set of traffic and geometric conditions. Whenever possible, the analyst should estimate as many of these parameters as possible to obtain the broadest possible evaluation of the performance of a given roundabout design. In all cases, a capacity estimate must be obtained for an entry to the roundabout before a specific performance measure can be computed.

Key performance measures for roundabouts:

- Degree of saturation
- Delay
- Queue length

4.4.1 Degree of saturation

Degree of saturation is the ratio of the demand at the roundabout entry to the capacity of the entry. It provides a direct assessment of the sufficiency of a given design. While there are no absolute standards for degree of saturation, the Australian design procedure suggests that the degree of saturation for an entry lane should be less than 0.85 for satisfactory operation. When the degree of saturation exceeds this range, the operation of the roundabout will likely deteriorate rapidly, particularly over short periods of time. Queues may form and delay begins to increase exponentially.

4.4.2 Delay

Delay is a standard parameter used to measure the performance of an intersection. The *Highway Capacity Manual* (1) identifies delay as the primary measure of effectiveness for both signalized and unsignalized intersections, with level of service determined from the delay estimate. Currently, however, the *Highway Capacity Manual* only includes control delay, the delay attributable to the control device. Control delay is the time that a driver spends queuing and then waiting for an acceptable gap in the circulating flow while at the front of the queue. The formula for computing this delay is given in Equation 4-7 (12, based on 13; see also 14). Exhibit 4-9 shows how control delay at an entry varies with entry capacity and circulating flow. Each curve for control delay ends at a volume-to-capacity ratio of 1.0, with the curve projected beyond that point as a dashed line.

$$d = \frac{3600}{c_{m,x}} + 900T \times \left[\frac{v_x}{c_{m,x}} - 1 + \sqrt{\left(\frac{v_x}{c_{m,x}} - 1 \right)^2 + \frac{\left(\frac{3600}{c_{m,x}} \right) \left(\frac{v_x}{c_{m,x}} \right)}{450T}} \right] \quad (4-7)$$

where: d = average control delay, sec/veh;
 v_x = flow rate for movement x , veh/h;
 $c_{m,x}$ = capacity of movement x , veh/h; and
 T = analysis time period, h ($T = 0.25$ for a 15-minute period).

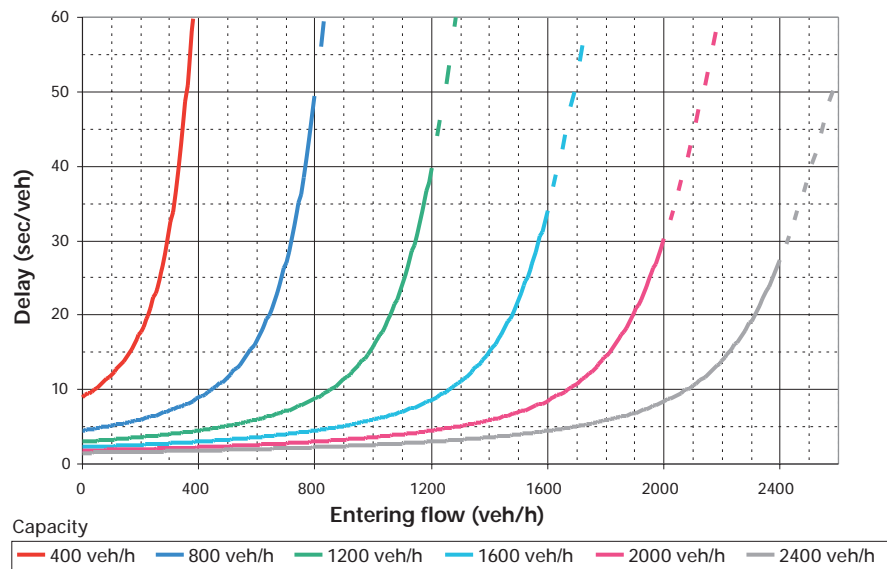

Exhibit 4-9. Control delay as a function of capacity and entering flow.

Note that as volumes approach capacity, control delay increases exponentially, with small changes in volume having large effects on delay. An accurate analysis of delay under conditions near or over saturation requires consideration of the following factors:

- *The effect of residual queues.* Roundabout entries operating near or over capacity can generate significant residual queues that must be accounted for between consecutive time periods. The method presented above does not account for these residual queues. These factors are accounted for in the delay formulae developed by Kimber and Hollis (15); however, these formulae are difficult to use manually.
- *The metering effect of upstream oversaturated entries.* When an upstream entry is operating over capacity, the circulating volume in front of a downstream entry is less than the true demand. As a result, the capacity of the downstream entry is higher than what would be predicted from analyzing actual demand.

For most design applications where target degrees of saturation are no more than 0.85, the procedures presented in this section are sufficient. In cases where it is desired to more accurately estimate performance in conditions near or over capacity, the use of software that accounts for the above factors is recommended.

Geometric delay is the additional time that a single vehicle with no conflicting flows spends slowing down to the negotiation speed, proceeding through the intersection, and accelerating back to normal operating speed. Geometric delay may

be an important consideration in network planning (possibly affecting route travel times and choices) or when comparing operations of alternative intersection types. While geometric delay is often negligible for through movements at a signalized or stop-controlled intersection, it can be more significant for turning movements such as those through a roundabout. Calculation of geometric delay requires an estimate of the proportion of vehicles that must stop at the yield line, as well as knowledge of the roundabout geometry as it affects vehicle speeds during entry, negotiation, and exit. Procedures for calculating the number of stops and geometric delay are given in the Australian design guide (16).

4.4.3 Queue length

Queue length is important when assessing the adequacy of the geometric design of the roundabout approaches.

The average queue length (L vehicles) can be calculated by Little's rule, as shown in Equation 4-8 (17):

$$L = v \cdot d / 3600 \quad (4-8)$$

where: v = entry flow, veh/h
 d = average delay, seconds/veh

Average queue length is equivalent to the vehicle-hours of delay per hour on an approach. It is useful for comparing roundabout performance with other intersection forms, and other planning procedures that use intersection delay as an input.

For design purposes, Exhibit 4-10 shows how the 95th-percentile queue length varies with the degree of saturation of an approach (18, 19). The x-axis of the graph is the degree of saturation, or the ratio of the entry flow to the entry capacity. Individual lines are shown for the product of T and entry capacity. To determine the 95th-percentile queue length during time T , enter the graph at the computed degree of saturation. Move vertically until the computed curve line is reached. Then move horizontally to the left to determine the 95th-percentile queue length. Alternatively, Equation 4-8 can be used to approximate the 95th-percentile queue. Note that the graph and equation are only valid where the volume-to-capacity ratio immediately before and immediately after the study period is no greater than 0.85 (in other words, the residual queues are negligible).

$$Q_{95} \approx 900T \left[\frac{v_x}{c_{m,x}} - 1 + \sqrt{\left(1 - \frac{v_x}{c_{m,x}}\right)^2 + \frac{\left(\frac{3600}{c_{m,x}}\right)\left(\frac{v_x}{c_{m,x}}\right)}{150T}} \right] \left(\frac{c_{m,x}}{3600}\right) \quad (4-9)$$

where: Q_{95} = 95th percentile queue, veh,
 v_x = flow rate for movement x, veh/h,
 $c_{m,x}$ = capacity of movement x, veh/h, and
 T = analysis time period, h (0.25 for 15-minute period).

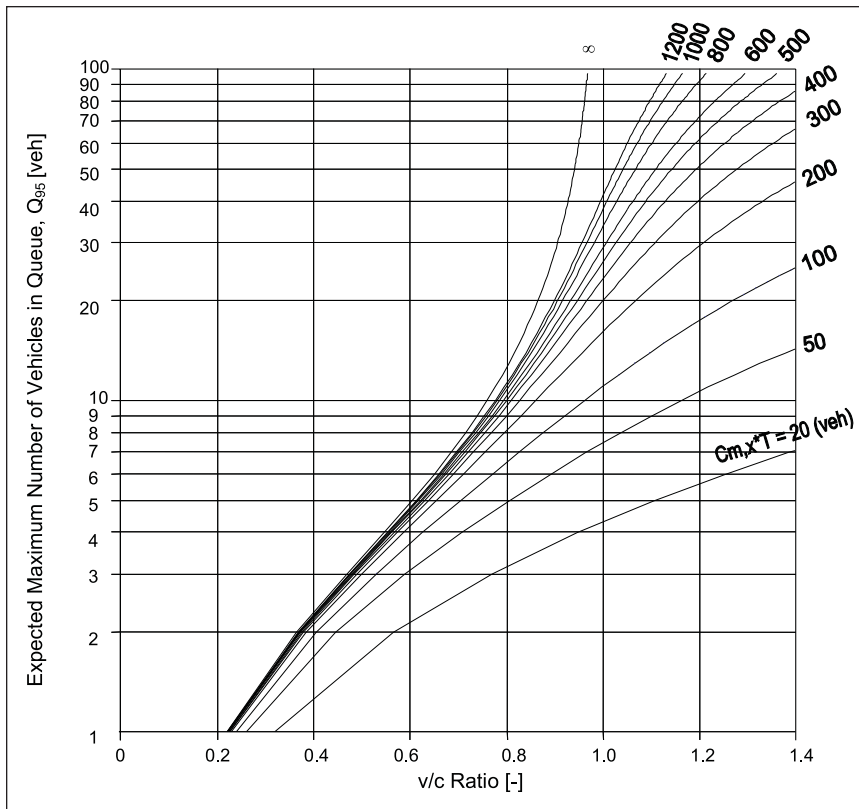

Source: (19)

Exhibit 4-10. 95th-percentile queue length estimation.

Points to consider for a qualitative assessment of roundabout performance.

4.4.4 Field observations

The analyst may evaluate an existing roundabout to determine its performance and whether changes to its design are needed. Measurements of vehicle delay and queuing can be made using standard traffic engineering techniques. In addition, the analyst can perform a qualitative assessment of the roundabout performance. The following list indicates conditions for which corrective design measures should be taken (20). If the answers to these questions are negative, no corrective actions need be taken.

- Do drivers stop unnecessarily at the yield point?
- Do drivers stop unnecessarily within the circulating roadway?
- Do any vehicles pass on the wrong side of the central island?
- Do queues from an external bottleneck back up into the roundabout from an exit road?
- Does the actual number of entry lanes differ from those intended by the design?
- Do smaller vehicles encroach on the truck apron?
- Is there evidence of damage to any of the signs in the roundabout?
- Is there any pedestrian activity on the central island?
- Do pedestrians and cyclists fail to use the roundabout as intended?
- Are there tire marks on any of the curb surfaces to indicate vehicle contact?
- Is there any evidence of minor accidents, such as broken glass, pieces of rim, etc., on the approaches or the circulating roadway?
- Is there any gravel or other debris collected in nontraveled areas that could be a hazard to bicycles or motorcyclists?
- Are the vehicle speeds appropriate?

4.5 Computer Software for Roundabouts

While the analytical procedures of different countries are not very complex, they are repetitive and time consuming, so most of these procedures have been implemented in software. A summary of current (as of 1999) software products and the analytical procedures that they implement is presented in Exhibit 4-11. The reader is also advised to consult the latest version of the U.S. *Highway Capacity Manual*. While the procedures provided in this chapter are recommended for most applications covered by this guide, models such as ARCADY, RODEL, SIDRA, KREISEL, or GIRABASE may be consulted to determine the effects of geometric parameters, particularly for multilane roundabouts outside the realm of this guide, or for fine-tuning designs to improve performance. Note that many of these models represent different underlying data or theories and will thus produce different results. Chapter 8 provides some information on microscopic simulation modeling which may be useful alternatives analysis in systems context.

Name	Scope	Application and Qualities (1999 versions)
ARCADY	All configurations	British method (50 percent confidence limits). Capacity, delay, and queuing. Includes projected number of crashes per year. Data were collected at extensive field studies and from experiments involving drivers at temporary roundabouts. Empirical relationships were developed from the data and incorporated into ARCADY. This model reflects British driving behavior and British roundabout designs. A prime attribute is that the capacities it predicts have been measured.
RODEL	All configurations including multiple roundabout interactions	British method (user-specified confidence limits). Capacity, delay, and queuing. Includes both an evaluation mode (geometric parameters specified) and a design mode (performance targets specified). Includes a crash prediction model. RODEL uses the British empirical equations. It also assists the user in developing an appropriate roundabout for the traffic conditions.
SIDRA	All configurations and other control types	Australian method, with analytical extensions. Capacity, delay, queue, fuel, and environmental measures. Also evaluates two-way stop-controlled, all-way stop controlled, and signalized intersections. It also gives roundabout capacities from U.S. HCM 1997 and German procedures. SIDRA is based on gap acceptance processes. It uses field data for the gap acceptance parameters to calibrate the model. There has been limited field evaluation of the results although experience has shown that the results fit Australian and U.S. single-lane (21) roundabout conditions satisfactorily. An important attribute is that the user can alter parameters to easily reflect local driving.
HCS-3	Single-lane roundabouts with a limited range of volumes	U.S. HCM 1997 method. Limited to capacity estimation based on entering and circulating volume. Optional gap acceptance parameter values provide both a liberal and conservative estimate of capacity. The data used to calibrate the models were recorded in the U.S. The two curves given reflect the uncertainty from the results. The upper-bound average capacities are anticipated at most roundabouts. The lower bound results reflect the operation that might be expected until roundabouts become more common.
KREISEL	All configurations	Developed in Germany. Offers many user-specified options to implement the full range of procedures found in the literature from U.S. (including this chapter), Europe, Britain, and Australia. KREISEL gives the average capacity from a number of different procedures. It provides a means to compare these procedures.
GIRABASE	All configurations	French method. Capacity, delay, and queuing projections based on regression. Sensitive to geometric parameters. Gives average values.

Exhibit 4-11.
Summary of
roundabout
software products
for operational
analysis.

4.6 References

1. Transportation Research Board. *Highway Capacity Manual*. Special Report 209. Washington, D.C.: Transportation Research Board, National Research Council, July 1999 (draft).
2. Kimber, R.M. *The traffic capacity of roundabouts*. TRRL Laboratory Report LR 942. Crowthorne, England: Transport and Road Research Laboratory, 1980.
3. Guichet, B. "Roundabouts In France: Development, Safety, Design, and Capacity." In *Proceedings of the Third International Symposium on Intersections Without Traffic Signals* (M. Kyte, ed.), Portland, Oregon, U.S.A. University of Idaho, 1997.
4. Brilon, W., N. Wu, and L. Bondzio. "Unsignalized Intersections in Germany—A State of the Art 1997." In *Proceedings of the Third International Symposium on Intersections without Traffic Signals* (ed: M. Kyte), Portland, Oregon, U.S.A. University of Idaho, 1997.
5. Ourston & Doctors, Inc. *Roundabout Design Guidelines*. 1995.
6. Jessen, G.D. *Ein Richtlinienvorschlag für die Behandlung der Leistungsfähigkeit von Knotenpunkten ohne Signalregelung* (A guideline suggested for capacity calculations for unsignalized intersections). *Strassenverkehrstechnik*, Nr. 7/8, 1968.
7. Harders, J. *Grenz- und Folgezeitlücken als Grundlage für die Berechnung der Leistungsfähigkeit von Landstrassen* (Critical gaps and follow-up times or capacity calculations at rural roads). *Schriftenreihe Strassenbau und Strassenverkehrstechnik*, Vol. 216, 1976.
8. Institute of Transportation Engineers. *Manual of Transportation Engineering Studies* (H.D. Robertson, J.E. Hummer, and D.C. Nelson, ed.). Englewood Cliffs, N.J.: Prentice-Hall, 1994.
9. Wu, N. "Capacity of Shared/Short Lanes at Unsignalized Intersections." In *Proceedings of the Third International Symposium on Intersections without Traffic Signals* (ed: M. Kyte), Portland, Oregon, U.S.A. University of Idaho, 1997.
10. Brilon, W., B. Stuwe, and O. Drews. *Sicherheit und Leistungsfähigkeit von Kreisverkehrsplätzen* (Safety and Capacity of Roundabouts). Research Report. Ruhr-University Bochum, 1993.
11. Brilon, W. Letter to Principal Investigator. September 18, 1999.
12. Transportation Research Board. *Highway Capacity Manual*. Special Report 209. Washington, D.C.: Transportation Research Board, National Research Council, 1994.
13. Akçelic, R., and R.J. Troutbeck. "Implementation of the Australian roundabout analysis method in SIDRA." In *Highway Capacity and Level of Service: Proceedings of the International Symposium on Highway Capacity* (U. Brannolte, ed.), Karlsruhe, Germany. Rotterdam, Germany: Balkema Publisher, 1991, pp. 17–34.

14. Transportation Research Board. *Review of International Practices Used to Evaluate Unsignalized Intersections*. Transportation Research Circular 468. Washington, D.C.: Transportation Research Board, National Research Council, April 1997.
15. Kimber, R.M. and E.M. Hollis. *Traffic queues and delays at road junctions*. TRRL Laboratory Report LR 909. Crowthorne, England: Transport and Road Research Laboratory, 1979.
16. Austroads. *Guide to Traffic Engineering Practice, Part 6—Roundabouts*. Sydney, Australia: Austroads, 1993.
17. Little, J.D.C. *A Proof of the Queueing Formula $L = W \cdot \lambda$* . Operations Research 9, S. 383–387, 1961.
18. Heidemann, D. "Queue lengths and waiting-time distributions at priority intersections." In *Transportation Research B*, Vol 25B, (4) pp. 163–174, 1991.
19. Wu, N. "An Approximation for the Distribution of Queue Lengths at Unsignalized Intersections." In *Proceedings of the Second International Symposium on Highway Capacity* (ed. R. Akçelik), Sydney, Australia. Australian Road Research Board, 1994.
20. Florida Department of Transportation. *Florida Roundabout Guide*. Florida Department of Transportation, March 1996.
21. Flannery, A., L. Elefteriadou, P. Koza, and J. McFadden. "Safety, delay and capacity of single-lane roundabouts in the United States." In *Transportation Research Record 1646*. Washington, D.C.: Transportation Research Board, National Research Council, 1998, pp. 63–70.



Safety

5.1	Introduction	103
5.2	Conflicts	104
5.2.1	Vehicle conflicts	105
5.2.2	Pedestrian conflicts	108
5.2.3	Bicycle conflicts	110
5.3	Crash Statistics	111
5.3.1	Comparisons to previous intersection treatment	111
5.3.2	Collision types	113
5.3.3	Pedestrians	117
5.3.4	Bicyclists	120
5.4	Crash Prediction Models	122
5.5	References	125
Exhibit 5-1.	Vehicle conflict points for “T” Intersections with single-lane approaches.	105
Exhibit 5-2.	Vehicle conflict point comparison for intersections with single-lane approaches.	106
Exhibit 5-3.	Improper lane-use conflicts in double-lane roundabouts.	107
Exhibit 5-4.	Improper turn conflicts in double-lane roundabouts.	108
Exhibit 5-5.	Vehicle-pedestrian conflicts at signalized intersections.	109
Exhibit 5-6.	Vehicle-pedestrian conflicts at single-lane roundabouts.	109
Exhibit 5-7.	Bicycle conflicts at conventional intersections (showing two left-turn options).	110

Exhibit 5-8.	Bicycle conflicts at roundabouts.	111
Exhibit 5-9.	Average annual crash frequencies at 11 U.S. intersections converted to roundabouts.	112
Exhibit 5-10.	Mean crash reductions in various countries.	112
Exhibit 5-11.	Reported proportions of major crash types at roundabouts.	113
Exhibit 5-12.	Comparison of collision types at roundabouts.	114
Exhibit 5-13.	Graphical depiction of collision types at roundabouts.	115
Exhibit 5-14.	Crash percentage per type of user for urban roundabouts in 15 towns in western France.	116
Exhibit 5-15.	British crash rates for pedestrians at roundabouts and signalized intersections.	117
Exhibit 5-16.	Percentage reduction in the number of crashes by mode at 181 converted Dutch roundabouts.	117
Exhibit 5-17.	British crash rates (crashes per million trips) for bicyclists and motorcyclists at roundabouts and signalized intersections.	120
Exhibit 5-18.	A comparison of crashes between signalized and roundabout intersections in 1998 in 15 French towns.	120

Chapter 5 Safety

Roundabouts may improve the safety of intersections by eliminating or altering conflict types, by reducing speed differentials at intersections, and by forcing drivers to decrease speeds as they proceed into and through the intersection. Though roundabout crash records in the United States are limited, the experiences of other countries can be used to help design roundabouts in this country. Understanding the sensitivity of geometric element parameters, along with the crash experience, will assist the designer in optimizing the safety of all vehicle occupants, pedestrians, and bicyclists.

5.1 Introduction

Many studies have found that one of the benefits of roundabout installation is the improvement in overall safety performance. Several studies in the U.S., Europe, and Australia have found that roundabouts perform better in terms of safety than other intersection forms (1, 2, 3, 4). In particular, single-lane roundabouts have been found to perform better than two-way stop-controlled (TWSC) intersections in the U.S. (5). Although the frequency of reported crashes is not always lower at roundabouts, the reduced injury rates are usually reported (6). Safety is better at small and medium capacity roundabouts than at large or multilane roundabouts (1, 7). While overall crash frequencies have been reduced, the crash reductions are most pronounced for motor vehicles, less pronounced for pedestrians, and equivocal for bicyclists, depending on the study and bicycle design treatments (4, 6, 7). Crash statistics for various user groups are reported in Section 5.3.

The reasons for the increased safety level at roundabouts are:

- Roundabouts have fewer conflict points in comparison to conventional intersections. The potential for hazardous conflicts, such as right angle and left turn head-on crashes is eliminated with roundabout use. Single-lane approach roundabouts produce greater safety benefits than multilane approaches because of fewer potential conflicts between road users, and because pedestrian crossing distances are short.
- Low absolute speeds associated with roundabouts allow drivers more time to react to potential conflicts, also helping to improve the safety performance of roundabouts.
- Since most road users travel at similar speeds through roundabouts, i.e., have low relative speeds, crash severity can be reduced compared to some traditionally controlled intersections.
- Pedestrians need only cross one direction of traffic at a time at each approach as they traverse roundabouts, as compared with unsignalized intersections. The conflict locations between vehicles and pedestrians are generally not affected by the presence of a roundabout, although conflicting vehicles come from a more defined path at roundabouts (and thus pedestrians have fewer places to check for conflicting vehicles). In addition, the speeds of motorists entering and exiting a roundabout are reduced with good design. As with other crossings

Roundabouts may improve intersection safety by:

- **Eliminating or altering conflicts**
- **Decreasing speeds into and through the intersection**
- **Decreasing speed differentials**

requiring acceptance of gaps, roundabouts still present visually impaired pedestrians with unique challenges, as described in Chapter 2.

For the design of a new roundabout, safety can be optimized not only by relying on recorded past performance of roundabouts in general, but primarily by applying all design knowledge proven to impact safety. For optimum roundabout safety and operational performance the following should be noted:

- Minimizing the number of potential conflicts at any geometric feature should reduce the multiple vehicle crash rate and severity.
- Minimizing the potential relative speed between two vehicles at the point of conflict will minimize the multiple vehicle crash rate and severity (it may also optimize capacity). To reduce the potential relative speed between vehicles, either the absolute speeds of both vehicles need to be reduced or the angle between the vehicle paths needs to be reduced. Commuter bicyclist speeds can range from 20 to 25 km/h (12 to 15 mph) and designs that constrain the speeds of motor vehicles to similar values will minimize the relative speeds and improve safety. Lower absolute speeds will also assist pedestrian safety.
- Limiting the maximum change in speed between successive horizontal geometric elements will minimize the single vehicle crash rate and severity.

5.2 Conflicts

Conflict points occur where one vehicle path crosses, merges or diverges with, or queues behind the path of another vehicle, pedestrian, or bicycle.

The frequency of crashes at an intersection is related to the number of *conflict points* at an intersection, as well as the magnitude of conflicting flows at each conflict point. A conflict point is a location where the paths of two motor vehicles, or a vehicle and a bicycle or pedestrian queue, diverge, merge, or cross each other.

Besides conflicts with other road users, the central island of a roundabout presents a particular hazard that may result in over-representation of single-vehicle crashes that tend to occur during periods of low traffic volumes. At cross intersections, many such violations may go unrecorded unless a collision with another vehicle occurs.

Conflicts can arise from both legal and illegal maneuvers; many of the most serious crashes are caused by failure to observe traffic control devices.

The following sections present a variety of conflicts among vehicles, bicycles, and pedestrians. Both legal conflicts (queuing at an intersection, merging into a traffic stream) and conflicts prohibited by law or by traffic control devices (failure to yield to pedestrians, running a stop sign) have been included for completeness. Even though traffic control devices can significantly reduce many conflicts, they can not eliminate them entirely due to violations of those devices. Many of the most serious crashes are caused by such violations.

As with crash analyses, conflict analyses are more than the simple enumeration of the number of conflicts. A conflict analysis should account for the following factors:

- Existence of conflict point;

- Exposure, measured by the product of the two conflicting stream volumes at a given conflict point;
- Severity, based on the relative velocities of the conflicting streams (speed and angle); and
- Vulnerability, based on the ability for a member of each conflicting stream to survive a crash.

5.2.1 Vehicle conflicts

5.2.1.1 Single-lane roundabouts

Exhibit 5-1 presents a diagram of vehicle-vehicle conflict points for a traditional three-leg (“T”) intersection and a three-leg roundabout. As the figure shows, the number of vehicle-vehicle conflict points for roundabouts decreases from nine to six for three-leg intersections. Note that these diagrams do not take into account the ability to separate conflicts in space (through the use of separate left or right turning lanes) or time (through the use of traffic control devices such as stop signs or traffic signals).

Roundabouts bring the simplicity of a “T” intersection to intersections with more than three legs.

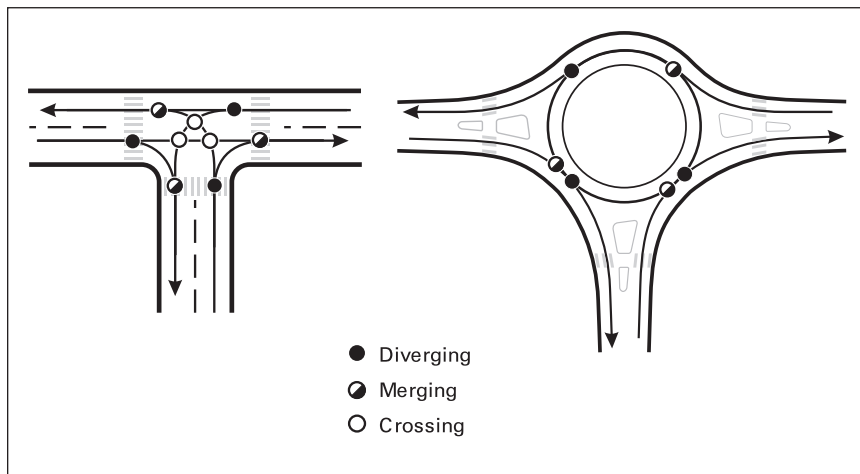
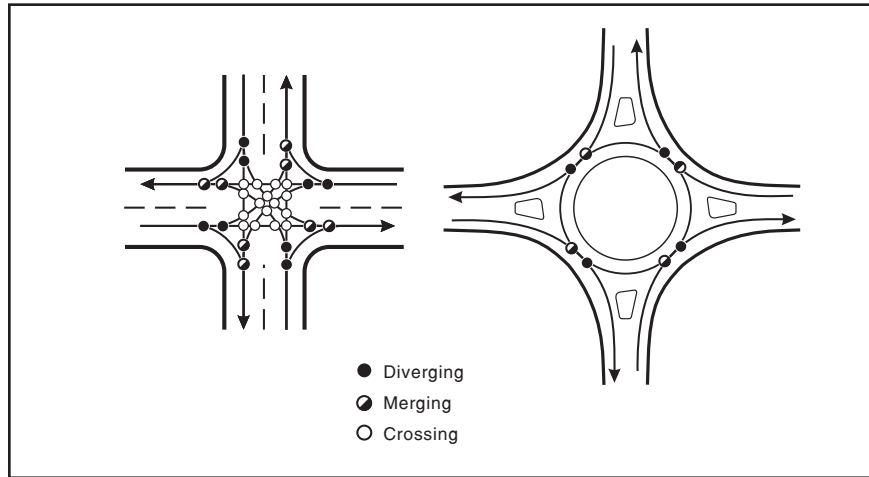

Exhibit 5-1. Vehicle conflict points for “T” Intersections with single-lane approaches.

Exhibit 5-2 presents similar diagrams for a traditional four-leg (“X” or “cross”) intersection and a four-leg roundabout. As the figure shows, the number of vehicle-vehicle conflict points for roundabouts decreases from 32 to 8 for four-leg intersections.

Exhibit 5-2. Vehicle conflict point comparison for intersections with single-lane approaches.

A four-leg single-lane roundabout has 75% fewer vehicle conflict points—compared to a conventional intersection.



Conflicts can be divided into three basic categories, in which the degree of severity varies, as follows:

- *Queuing conflicts.* These conflicts are caused by a vehicle running into the back of a vehicle queue on an approach. These types of conflicts can occur at the back of a through-movement queue or where left-turning vehicles are queued waiting for gaps. These conflicts are typically the least severe of all conflicts because the collisions involve the most protected parts of the vehicle and the relative speed difference between vehicles is less than in other conflicts.
- *Merge and diverge conflicts.* These conflicts are caused by the joining or separating of two traffic streams. The most common types of crashes due to merge conflicts are sideswipes and rear-end crashes. Merge conflicts can be more severe than diverge conflicts due to the more likely possibility of collisions to the side of the vehicle, which is typically less protected than the front and rear of the vehicle.
- *Crossing conflicts.* These conflicts are caused by the intersection of two traffic streams. These are the most severe of all conflicts and the most likely to involve injuries or fatalities. Typical crash types are right-angle crashes and head-on crashes.

Crossing conflicts are the most severe and carry the highest public cost.

As Exhibit 5-1 and Exhibit 5-2 show, a roundabout reduces vehicular crossing conflicts for both three- and four-leg intersections by converting all movements to right turns. Again, separate turn lanes and traffic control (stop signs or signalization) can often reduce but not eliminate the number of crossing conflicts at a traditional intersection by separating conflicts in space and/or time. However, the most severe crashes at signalized intersections occur when there is a violation of the traffic control device designed to separate conflicts by time (e.g., a right-angle collision due to running a red light, and vehicle-pedestrian collisions). Therefore, the ability of single-lane roundabouts to reduce conflicts through physical, geometric features has been demonstrated to be more effective than the reliance on driver obedience of traffic control devices.

5.2.1.2 Double-lane roundabouts

In general, double-lane roundabouts have some of the same safety performance characteristics as their simpler single-lane counterparts. However, due to the presence of additional entry lanes and the accompanying need to provide wider circulatory and exit roadways, double lane roundabouts introduce additional conflicts not present in single-lane roundabouts. This makes it important to use the minimum required number of entry, circulating and exit lanes, subject to capacity considerations. For example, according to United Kingdom roundabout crash models, for a 10,000 entering Average Daily Traffic (ADT), flaring the entry width from one to two lanes is likely to increase injury crashes by 25 percent (8).

The number of vehicular and pedestrian conflicts points in both conventional intersections and roundabouts increases considerably when they have additional approach lanes. The designer is encouraged to graphically determine conflicts for a particular location, as this information can raise awareness of design issues and may be useful in public presentations.

The types of conflicts present in multilane roundabouts that do not exist in single-lane roundabouts occur when drivers use the incorrect lane or make an improper turn. These types of conflicts are depicted in Exhibit 5-3 and Exhibit 5-4, respectively. While these types of conflicts can also be present in other intersection forms, they can be prevalent with drivers who are unfamiliar with roundabout operation. The conflicts depicted in Exhibit 5-4, in particular, can be created by not providing a proper design geometry that allows vehicles to travel side-by-side throughout the entire roundabout (see Chapter 6). Crashes resulting from both types of conflicts can also be reduced through proper driver education.

Double-lane roundabouts have some of the same safety performance characteristics as single-lane roundabouts, but introduce additional conflicts.

Incorrect lane use and incorrect turns are multilane roundabout conflicts that do not exist in single-lane roundabouts.

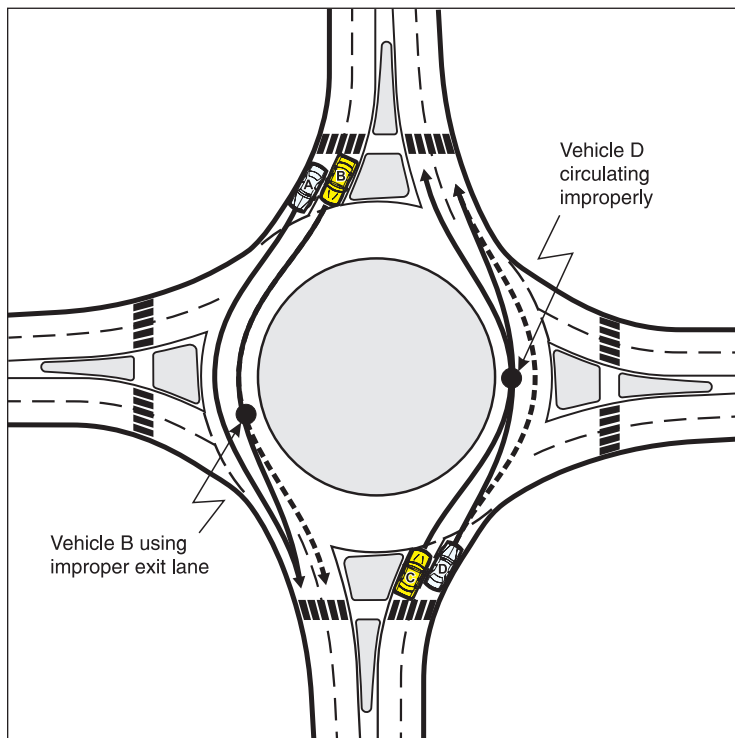
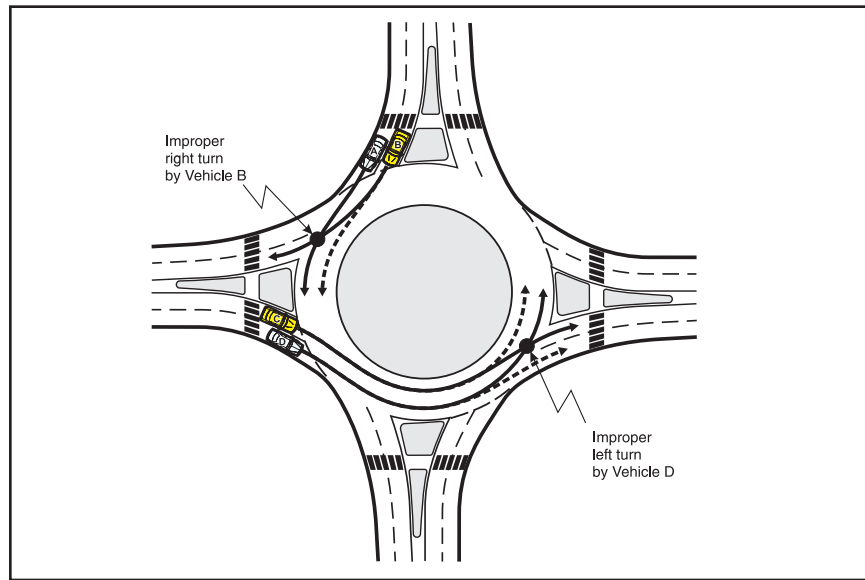

Exhibit 5-3. Improper lane-use conflicts in double-lane roundabouts.

Exhibit 5-4. Improper turn conflicts in double-lane roundabouts.



As with single-lane roundabouts, the most severe vehicular crossing conflicts are eliminated and replaced by less severe merging conflicts. The additional conflicts unique to multilane roundabouts are generally low-speed sideswipe conflicts that typically have low severity. Therefore, although the number of conflict points increases at multilane roundabouts when compared to a single lane roundabouts, the overall severity of conflicts is generally less than alternative intersection control.

5.2.2 Pedestrian conflicts

Vehicle-pedestrian conflicts can be present at every intersection, even those with minimal pedestrian volume. The following sections examine pedestrian conflicts at signalized intersections and at roundabouts.

Signalized intersections offer the opportunity to reduce the likelihood of pedestrian-vehicle conflicts through the use of signal phasing that allows only a few movements to move legally at any given time. Exhibit 5-5 summarizes the typical pedestrian conflicts present on one approach to a signalized intersection. As the exhibit shows, a pedestrian crossing at a typical signalized intersection (permitted or protected-permitted left turns, right turns on red allowed) faces four potential vehicular conflicts, each coming from a different direction:

- Crossing movements on red (typically high-speed, illegal)
- Right turns on green (legal)
- Left turns on green (legal for protected-permitted or permitted left turn phasing)
- Right turns on red (typically legal)

Types of pedestrian crossing conflicts present at signalized intersections.

In terms of exposure, the illegal movements should be accorded a lower weight than legal conflicts. However, they may be accorded an offsetting higher weight in terms of severity. For an intersection with four single-lane approaches, this results in a total of 16 pedestrian-vehicle conflicts.

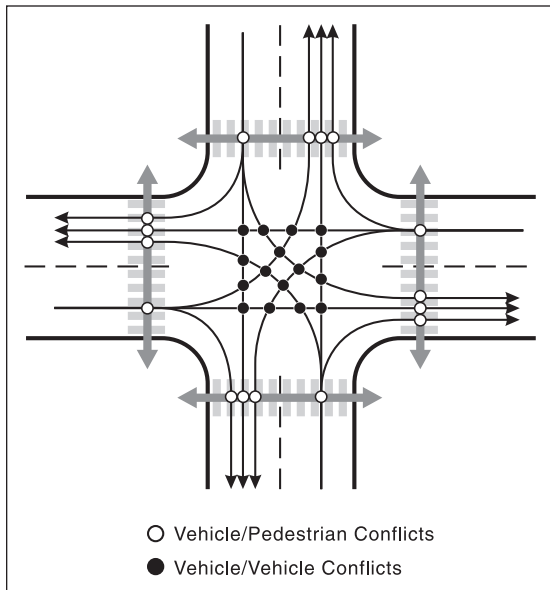

Exhibit 5-5. Vehicle-pedestrian conflicts at signalized intersections.

Pedestrians at roundabouts, on the other hand, face two conflicting vehicular movements on each approach, as depicted in Exhibit 5-6:

- Conflict with entering vehicles; and
- Conflict with exiting vehicles.

The direction conflicting vehicles will arrive from is more predictable for pedestrians at roundabouts.

At conventional and roundabout intersections with multiple approach lanes, an additional conflict is added with each additional lane that a pedestrian must cross.

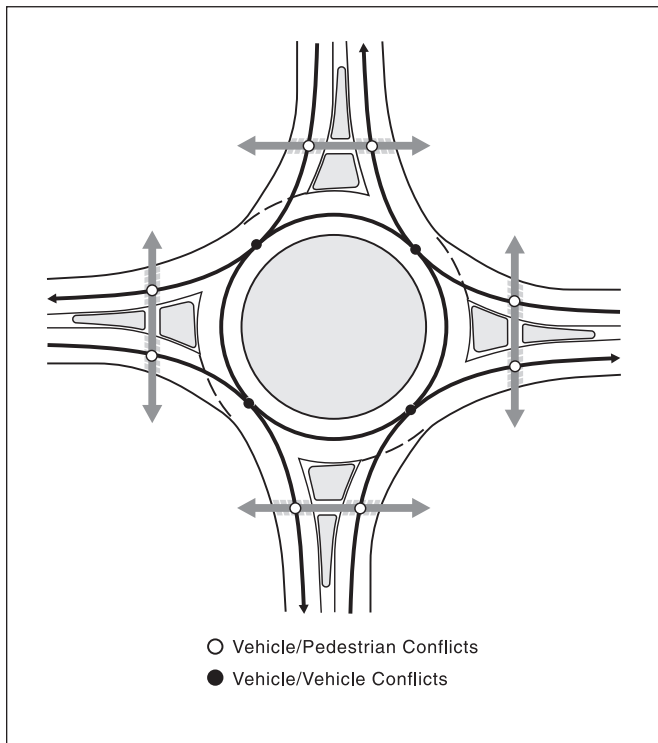
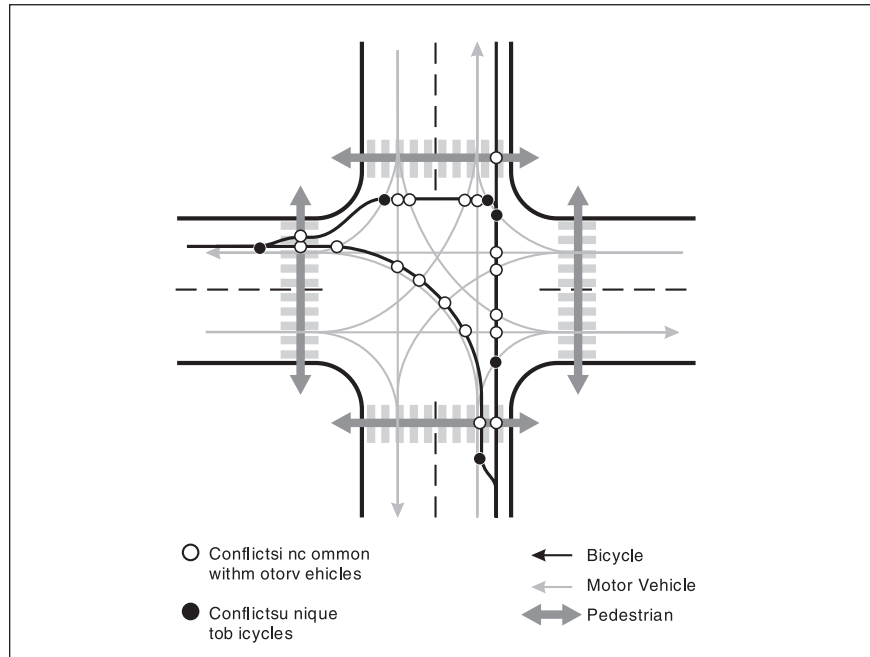

Exhibit 5-6. Vehicle-pedestrian conflicts at single-lane roundabouts.

5.2.3 Bicycle conflicts

Bicycles face similar conflicts as motor vehicles at both signalized intersections and roundabouts. However, because bicyclists typically ride on the right side of the road between intersections, they face additional conflicts due to overlapping paths with motor vehicles. Conflicts unique to bicyclists occur on each approach to conventional four-leg intersections, as depicted in Exhibit 5-7 (showing left turns like motor vehicles or left turns like pedestrians).

Exhibit 5-7. Bicycle conflicts at conventional intersections (showing two left-turn options).



Bicycles can be provided with the option of traveling as either a vehicle or a pedestrian through a roundabout.

At roundabouts, bicycles may be provided the option of traveling as a vehicle or as a pedestrian. As a result, the conflicts experienced by bicyclists are dependent on how they choose to negotiate the roundabout, as shown in Exhibit 5-8. When traveling as a vehicle at a single-lane roundabout, an additional conflict occurs at the point where the bicyclist merges into the traffic stream; the remainder are similar to those for motor vehicles. At double-lane and larger roundabouts where bicycles are typically traveling on the outside part of the circulatory roadway, bicyclists face a potential conflict with exiting vehicles where the bicyclist is continuing to circulate around the roundabout. Bicyclists may feel compelled to "negotiate" the circle (e.g., by indicating their intentions to drivers with their arms) while avoiding conflicts where possible. Bicyclists are less visible and therefore more vulnerable to the merging and exiting conflicts that happen at double-lane roundabouts.

When traveling as a pedestrian, an additional conflict for bicyclists occurs at the point where the bicyclist gets onto the sidewalk, at which point the bicyclist continues around the roundabout like a pedestrian. On shared bicycle-pedestrian paths or on sidewalks, if bicyclists continue to ride, additional bicycle-pedestrian conflicts occur wherever bicycle and pedestrian movements cross (not shown on the exhibit).

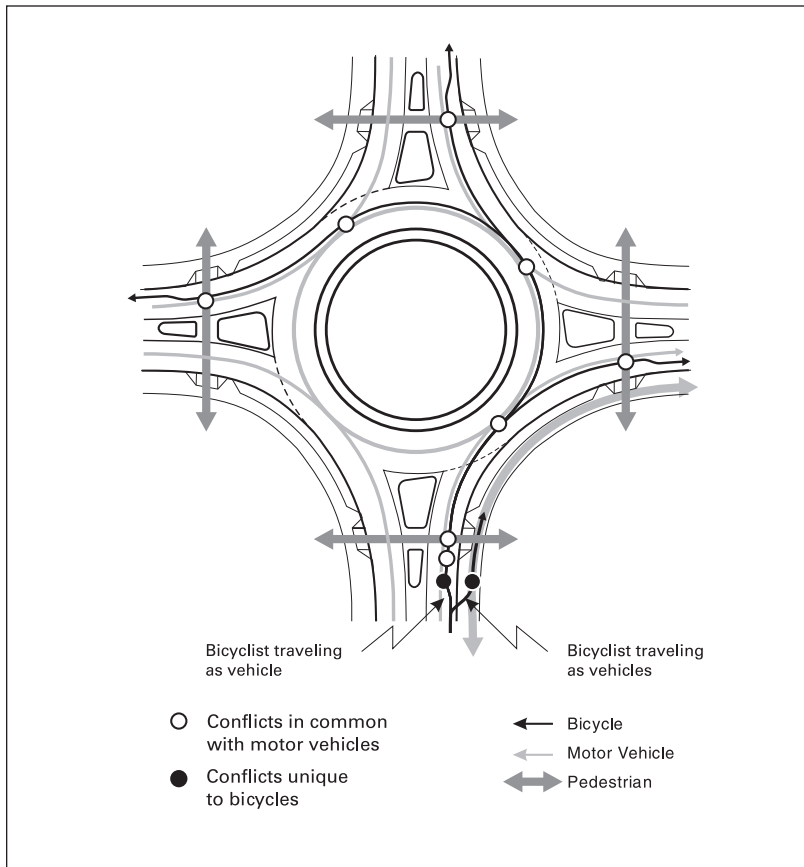

Exhibit 5-8. Bicycle conflicts at roundabouts (showing two left-turn options).

Bicycle-pedestrian conflicts can also occur on shared pathways adjacent to the roundabout.

5.3 Crash Statistics

This section summarizes the overall safety performance of roundabouts in various countries (including the U.S.) and then examines the detailed collision types experienced in France and Queensland, Australia. Pedestrian and bicycle crash statistics are discussed separately, including design issues for visually impaired pedestrians.

5.3.1 Comparisons to previous intersection treatment

Exhibit 5-9 shows the crash frequencies (average annual crashes per roundabout) experienced at eleven intersections in the U.S. that were converted to roundabouts. As the exhibit shows, both types of roundabouts showed a reduction in both injury and property-damage crashes after installation of a roundabout. It should be noted that due to the small size of the data sample, the only result that is statistically significant is the injury crash reduction for small and moderate roundabouts.

Exhibit 5-9. Average annual crash frequencies at 11 U.S. intersections converted to roundabouts.

Type of Roundabout	Sites	Before Roundabout			Roundabout			Percent Change ⁵		
		Total Inj. ³	PDO ⁴	PDO ⁴	Total Inj.	PDO	PDO	Total Inj.	PDO	PDO
Small/Moderate ¹	8	4.8	2.0	2.4	2.4	0.5	1.6	-51%	73%	-32%
Large ²	3	21.5	5.8	15.7	15.3	4.0	11.3	-29%	-31%	-10%
Total	11	9.3	3.0	6.0	5.9	1.5	4.2	-37%	-51%	-29%

Notes:

1. Mostly single-lane roundabouts with an inscribed circle diameter of 30 to 35 m (100 to 115 ft).

2. Multilane roundabouts with an inscribed circle diameter greater than 50 m (165 ft).

3. Inj. = Injury crashes

4. PDO = Property Damage Only crashes

5. Only injury crash reductions for small/moderate roundabouts were statistically significant.

Source: (9)

Compared to results from Australia, France, and the United Kingdom, these crash frequencies are quite high. Annual crash frequencies in France, Australia, and United Kingdom of 0.15, 0.6, and 3.31 injury crashes per roundabout, respectively, have been reported (1, 10). The reader should note that the UK has many high-volume, multilane roundabouts.

In spite of the higher frequencies, injury crash *rates*, which account for traffic volume exposure, are significantly lower at U.S. roundabout sites. In a recent study of eight single-lane roundabouts in Maryland and Florida, the injury crash rate was found to be 0.08 crashes per million entering vehicles (5). By comparison, the injury crash rate was reported to be 0.045 crashes per million entering vehicles in France and 0.275 crashes per million entering vehicles in the United Kingdom (1, 10).

Experiences in the United States show a reduction in crashes after building a roundabout of about 37 percent for all crashes and 51 percent for injury crashes. These values correspond with international studies with much larger sample sizes, as shown in Exhibit 5-10.

Exhibit 5-10. Mean crash reductions in various countries.

Country	Mean Reduction (%)	
	All Crashes	Injury Crashes
Australia	41 - 61%	45 - 87%
France		57 - 78%
Germany	36%	
Netherlands	47%	
United Kingdom		25 - 39%
United States	37%	51%

Source: (2), France: (11)

The findings of these studies show that injury crashes are reduced more dramatically than crashes involving property damage only. This again is in part due to the configuration of roundabouts, which eliminates severe crashes such as left turn, head-on, and right angle collisions. Most of these studies also show that crash reduction in rural areas is much higher than in urban areas.

Note that the geometry of many studied sites may not necessarily conform to good roundabout design. Improved design principles, such as an emphasis on achieving consistent speeds, may result in better safety performance. It should also be noted that these crash reductions are generally for sites where roundabouts were selected to replace problem intersections. Therefore, they do not necessarily represent a universal safety comparison with all other intersection types.

Collisions at roundabouts tend to be less severe than at conventional intersections. Most crashes reported at roundabouts are a result of drivers failing to yield on entry, referred to as entering-circulating crashes. In addition, rear-end collisions and single vehicle crashes have been reported in many studies. Exhibit 5-11 shows the percentage of the three main crash types reported in different countries.

Caveats for comparing the results of crash studies.

Country	Crash Description	Type of Roundabout	Type of Crash ¹		
			Entering-circulating	Rear-end	Single Vehicle
Australia	All crashes	Single and multilane	51%	22%	18%
France	Injury crashes	Single and multilane	37%	13%	28%
Germany	All crashes	Single lane	30%	28%	17%
Switzerland	All crashes	Single and multilane	46%	13%	35%
United Kingdom	Injury crashes	Single and multilane	20 - 71%	7 - 25%	8 - 30%

Exhibit 5-11. Reported proportions of major crash types at roundabouts.

1. Percentages do not necessarily sum to 100% because only three major crash categories are shown. Source: (10)

5.3.2 Collision types

It is instructive for designers to examine details of collision types and location at roundabouts. Statistics are available for roundabouts designed according to local practices in France, Queensland (Australia), and the United Kingdom. It should be noted that the reported frequencies are to some extent related to the specific design standards and reporting processes used in these countries.

Exhibit 5-12 presents a summary of the percentage of crashes by collision type. The numbered items in the list correspond to the numbers indicated on the diagrams given in Exhibit 5-13 as reported in France. The French data illustrate collision types for a sample of 202 injury crashes from 179 urban and suburban roundabouts in France for the period 1984–1988 (12). For comparison purposes, data

from Queensland, Australia (13) and the United Kingdom (1) have been superimposed onto the same classification system.

The results in Exhibit 5-12 are instructive for a number of reasons:

- A variety of collision types can take place at roundabouts. A designer should be aware of these collision types when making decisions about alignment and location of fixed objects. It is recommended that these collision types be adopted as conflict types in the U.S. to conduct traffic conflict analysis and report crashes at roundabouts.
- Although reporting methodologies may vary somewhat, crash experience varies from country to country. This may be due to a combination of differences in driver behavior, and design features.

Exhibit 5-12. Comparison of collision types at roundabouts.

Collision Type	France	Queensland (Australia)	United Kingdom ¹
1. Failure to yield at entry (entering-circulating)	36.6%	50.8%	71.1%
2. Single-vehicle run off the circulatory roadway	16.3%	10.4%	8.2% ²
3. Single vehicle loss of control at entry	11.4%	5.2%	²
4. Rear-end at entry	7.4%	16.9%	7.0% ³
5. Circulating-exiting	5.9%	6.5%	
6. Pedestrian on crosswalk	5.9%		3.5% ⁴
7. Single vehicle loss of control at exit	2.5%	2.6%	²
8. Exiting-entering	2.5%		
9. Rear-end in circulatory roadway	0.5%	1.2%	
10. Rear-end at exit	1.0%	0.2%	
11. Passing a bicycle at entry	1.0%		
12. Passing a bicycle at exit	1.0%		
13. Weaving in circulatory roadway	2.5%	2.0%	
14. Wrong direction in circulatory roadway	1.0%		
15. Pedestrian on circulatory roadway	3.5%		⁴
16. Pedestrian at approach outside crosswalk	1.0%		⁴
Other collision types		2.4%	10.2%
Other sideswipe crashes		1.6%	

Notes:

1. Data are for "small" roundabouts (curbed central islands > 4 m [13 ft] diameter, relatively large ratio of inscribed circle diameter to central island size)

2. Reported findings do not distinguish among single-vehicle crashes.

3. Reported findings do not distinguish among approaching crashes.

4. Reported findings do not distinguish among pedestrian crashes.

Sources: France (12), Australia (13), United Kingdom (1)

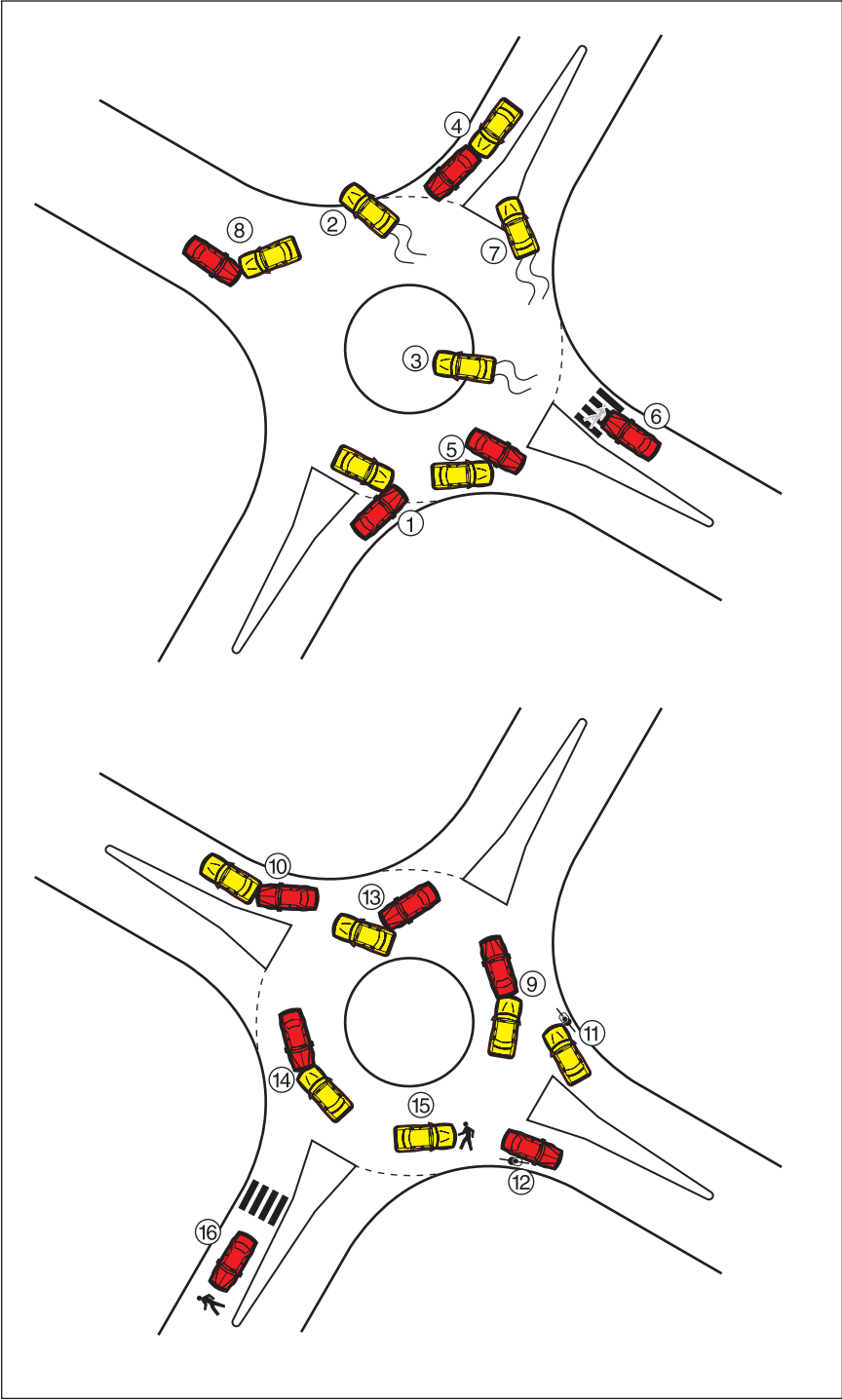

Exhibit 5-13. Graphical depiction of collision types at roundabouts.

Source (8)

Three of the predominant types of collision are: (1) failures to yield at entry to circulating vehicles, (2) single vehicle run-off the circulatory roadway, and (3) single vehicle run-into the central island. A more recent crash study (14) confirmed a high proportion of single vehicle crashes: 49 percent in rural areas, versus 21 percent in urban areas. According to crash models from the United Kingdom, single vehicle crashes range between 20 and 40 percent depending on traffic and design characteristics of sites. In the United Kingdom models, separation by urban and rural areas is not provided.

To reduce the severity of single vehicle crashes, special attention should be accorded to improving visibility and avoiding or removing any hard obstacles on the central island and splitter islands in both urban and rural environments. A French study (14) identified a number of major obstacles that caused fatalities and injuries: trees, guardrail, concrete barriers, fences, walls, piers, sign or light poles, landscaping pots or hard decorative objects, and steep cross-slopes on the central island.

In rural areas, the benefit of lighting has not yet been quantified. In France, only 36 percent of the rural sites are lighted. At these sites, 46 percent of all crashes, and 49 percent of single vehicle crashes occur at night (14).

The French study (7) in 15 towns of 202 urban roundabout crashes compared with all crossroads reported the percentage of crashes by user type, as shown in Exhibit 5-14. The percentage of crashes concerning pedestrians was similar to all crossroads. However, the percentage of crashes involving bicycles and mopeds was larger—15.4 percent for urban crossroads overall versus 24.2 percent for roundabouts, i.e., almost 60 percent more.

Exhibit 5-14. Crash percentage per type of user for urban roundabouts in 15 towns in western France.

User	All Crossroads	Roundabouts
Pedestrians	6.3%	5.6%
Bicycles	3.7%	7.3%
Mopeds	11.7%	16.9%
Motor cycles	7.4%	4.8%
Cars	65.7%	61.2%
Utility vehicles	2.0%	0.6%
Heavy goods vehicles	2.0%	3.0%
Bus/coach	0.8%	0.6%
Miscellaneous	0.4%	0.0%
Total	100.0%	100.0%

Source: (7)

5.3.3 Pedestrians

As was described previously, vehicular injury crashes normally decrease when roundabouts are installed at an existing intersection. The safety benefits of roundabouts have been found to generally carry over to pedestrians as well, as shown in British statistics of Exhibit 5-15. This may be due to the reduced speeds at roundabouts as compared with the previous intersection forms.

Intersection Type	Pedestrian Crashes per Million Trips
Mini-roundabout	0.31
Conventional roundabout	0.45
Flared roundabout	0.33
Signals	0.67

Source: (1, 15)

Exhibit 5-15. British crash rates for pedestrians at roundabouts and signalized intersections.

For pedestrians, the risk of being involved in a severe collision is lower at roundabouts than at other forms of intersections, due to the slower vehicle speeds. Likewise, the number of conflict points for pedestrians is lower at roundabouts than at other intersections, which can lower the frequency of collisions. The splitter island between entry and exit allows pedestrians to resolve conflicts with entering and exiting vehicles separately.

A Dutch study of 181 intersections converted to roundabouts (4) found reductions (percentage) in all pedestrian crashes of 73 percent and in pedestrian injury crashes of 89 percent. In this study, all modes shared in the safety benefits to greater (passenger cars) or lesser extents (bicycles), as shown in Exhibit 5-16.

Mode	All Crashes	Injury Crashes
Passenger car	63%	95%
Moped	34%	63%
Bicycle	8%	30%
Pedestrian	73%	89%
Total	51%	72%

Source: (4)

Exhibit 5-16. Percentage reduction in the number of crashes by mode at 181 converted Dutch roundabouts.

Zebra-stripe markings are recommended at most roundabouts to indicate pedestrian crossings.

A risk analysis of 59 roundabouts and 124 signalized intersections was carried out on crash data in Norway between 1985 and 1989. Altogether, 33 crashes involving personal injury were recorded at the 59 roundabouts. Only 1 of these crashes involved a pedestrian, compared with the signalized intersections, where pedestrians were involved in 20 percent of the personal injury crashes (57 of 287 injury crashes) (16).

Further, there is no quantitative evidence of increased safety for pedestrians at roundabouts with striped (zebra) crossings, where pedestrians have priority. Therefore, striped crossings have generally not been used in other countries. However, in the U.S., it is recommended that all crosswalks be striped except at rural locations with low pedestrian volumes. Although this is not their intended function, striped crosswalks may further alert approaching drivers to a change in their appropriate speed near the yield point.

Safety of visually impaired pedestrians at roundabouts requires further research.

Crash data have not been collected to indicate whether a pedestrian has a disability, and no studies have focused specifically on the safety of visually impaired pedestrians at roundabouts. This is an area requiring further research.

Challenges that roundabouts pose to visually impaired pedestrians.

5.3.3.1 Information access for blind or visually impaired pedestrians

Roundabout crossing skills may be difficult for disabled pedestrians to perform without assistance. For example, audible pedestrian-activated signals may be considered on an approach, although this treatment is not typical. Any leg of any roundabout could be equipped with a pedestrian-activated signal at the pedestrian crossing, if a balanced design requires providing assistance to pedestrians at that location. For example, motorized volume that is too heavy at times to provide a sufficient number of gaps acceptable for pedestrians may warrant a pedestrian signal equipped with audible devices to assist people with visual disabilities.

When crossing a roundabout, there are several areas of difficulty for pedestrians who are blind or visually impaired. It is desirable that a visually impaired pedestrian with good travel skills should be able to arrive at an unfamiliar intersection and cross it with pre-existing skills and without special, intersection-specific training. Roundabouts pose problems at several points of the crossing experience, from the perspective of their access to information:

- The first task of the visually impaired pedestrian is to locate the crosswalk. This can be difficult if the roundabout is not properly landscaped and if the curb edge of the ramp is not marked with a detectable warning surface (see Chapter 6). The crosswalk direction must also be unambiguous.
- Depending upon whether the visually impaired pedestrian is crossing the roundabout in a clockwise or counterclockwise direction, they must listen for a safe gap to cross either the entrance or exit lane(s). The primary problem is the sound of traffic on the roundabout, which may mask the sound of cars approaching the

crosswalk. While crossing the exit lane poses the greater hazard to the pedestrian who is visually impaired because of the higher speed of the vehicles, crossing the entrance may also pose significant problems. Entering traffic, while slower, may also be intimidating as it may not be possible to determine by sound alone whether a vehicle has actually stopped or intends to stop. Sighted pedestrians often rely upon communication through eye contact in these situations; however, that is not a useful or reliable technique for the pedestrian who is visually impaired. Both these problems are further exacerbated at roundabouts with multilane entrances and exits. In these roundabouts, a stopped car in the near lane may mask the sounds of other traffic. It may also block the view of the driver in the far lane of the cane or guide dog of a person who is visually impaired who begins to cross (this is also a problem for children and people using wheelchairs on any crossing of a multilane road).

- The third task is locating the splitter island pedestrian refuge. If this refuge is not ramped, curbed, or equipped with detectable warnings, it is not detectable by a pedestrian who is visually impaired.
- Crossing the remaining half of the crossing (see the second bullet above).
- Locating the correct walkway to either continue their path or locate the adjacent crosswalk to cross the next leg of the roundabout.

Unless these issues are addressed by a design, the intersection is “inaccessible” and may not be permissible under the ADA. Chapters 6 and 7 provide specific suggestions to assist in providing the above information. However, more research is required to develop the information jurisdictions need to determine where roundabouts may be appropriate and what design features are required for people with disabilities. Until specific standards are adopted, engineers and jurisdictions must rely on existing related research and professional judgment to design pedestrian features so that they are usable by pedestrians with disabilities.

Possible design remedies for the difficulties faced by pedestrians include tight entries, raised speed tables with detectable warnings, treatments for visually impaired pedestrians to locate crosswalks, raised pavement markers with yellow flashing lights to alert drivers of crossing pedestrians, pedestrian crossings with actuated signals set sufficiently upstream of the yield line to minimize the possibility of exiting vehicle queues spilling back into the circulatory roadway (6). However, the safety of these treatments at roundabouts has not been tested in the United States.

Chapters 6 and 7 provide suggestions on designing roundabouts to accommodate persons with disabilities.

5.3.4 Bicyclists

As shown in Exhibit 5-17, at British roundabouts bicyclists fare worse in terms of crashes at roundabouts than at signalized intersections.

Exhibit 5-17. British crash rates (crashes per million trips) for bicyclists and motorcyclists at roundabouts and signalized intersections.

Intersection Type	Bicyclists	Motorcyclists
Mini-roundabout	3.11	2.37
Conventional roundabout	2.91	2.67
Flared roundabout	7.85	2.37
Signals	1.75	2.40

Source: (1, 15)

A French study (7) compared the crashes in 1988 in 15 towns in the west of France at both signalized intersections and roundabouts, as shown in Exhibit 5-18. The conclusions from the analysis were:

- There were twice as many injury crashes per year at signalized intersections than at roundabouts;
- Two-wheel vehicles were involved in injury crashes more often (+77 percent) at signalized intersections than on roundabouts;
- People were more frequently killed and seriously injured per crash (+25 percent) on roundabouts than at signalized intersections;
- Proportionally, two-wheel vehicle users were more often involved in crashes (16 percent) on roundabouts than at signalized intersections. Furthermore, the consequences of such crashes were more serious.

Exhibit 5-18. A comparison of crashes between signalized and roundabout intersections in 1998 in 15 French towns.

	Signalized Crossroads	Roundabouts
Number of crossroads	1,238	179
Number of personal injuries	794	59
Number of crashes involving 2-wheel vehicles	278	28
Personal injury crashes/year/crossroad	0.64	0.33
2-wheel vehicle crashes/year/crossroad	0.23	0.13
Crashes to 2-wheel vehicles per 100 crashes	35.0	40.7
Serious crashes/year/crossroad	0.14	0.089
Serious crashes to 2-wheel vehicles/year/crossroad	0.06	0.045
Serious crashes/100 crashes	21.9	27.1
Serious crashes to 2-wheel vehicles/100 crashes to a 2-wheel vehicle	27.0	33.3

Source: (7)

All European countries report that a more careful design is necessary to enhance bicyclists' safety. The type of bicycle crashes depends on the bicycle facilities provided at the roundabout. If there are no bicycle facilities, or if there is a bike lane on the outer area of the circulatory roadway, crashes typically occur between entering cars and circulating bicyclists as well as between cars heading into an exit and circulating bicyclists. Improperly placed signs on the splitter island may also be a contributing factor.

Typical European practice is to provide separated bicycle facilities outside the circulatory roadway when vehicular and bicycle volumes are high.

As a result, most European countries have the following policies:

- Avoid bike lanes on the outer edge of the circulatory roadway.
- Allow bicyclists to mix with vehicle traffic without any separate facility in the circulatory roadway when traffic volumes are low, on single lane roundabouts operating at lower speeds (e.g., up to 8,000 vehicles per day in the Netherlands (4)).
- Introduce separated bicycle facilities outside the circulatory roadway when vehicular and bicycle volumes are high. These separated bicycle facilities cross the exits and entries at least one car length from the edge of the circulatory roadway lane, adjacent to the pedestrian crossings. In some countries, bicyclists have priority over entering and exiting cars, especially in urban areas (e.g., Germany). Other countries prefer to give priority to car traffic showing a yield sign to bicyclists (e.g., Netherlands). The latter solution (i.e., separate bicycle facilities with vehicular traffic priority at the crossing points) is the standard solution for rural areas in most European countries.

Speed is a fundamental risk factor in the safety of bicyclists and pedestrians. Typical bicyclist speeds are in the range of 20 to 25 km/h (12 to 15 mph), and designs that constrain the speeds of vehicles to similar values will minimize the relative speeds and thereby improve safety. Design features that slow traffic such as tightening entry curvature and entry width, and radial alignment of the legs of a roundabout, such as with the urban compact design, are considered safe treatments for bicyclists (17).

In the Netherlands, a 90 percent decrease in injury crashes was experienced with separate bicycle paths around roundabouts where bicyclists do not have right-of-way at the crossings (17).

A bicycle crash prediction model from Sweden has been validated against data for Swedish, Danish, and Dutch roundabouts (18). The model provides reasonable results for roundabouts with up to 12,000 vehicles per day and 4,000 bicycles per day. The model tends to over-predict crashes (i.e., is conservative) for roundabouts carrying more than 12,000 vehicles per day that are also designed with separate bicycle paths with crossings on the approach legs. It is calibrated for crossroad intersections as well as roundabouts. To obtain the expected cycling crashes per year at roundabouts, the value derived from the general junction model is factored by 0.71, implying that bicycle crashes at roundabouts are 71 percent less frequent than at junctions in general. However, the reader is cautioned when extrapolating European bicycling experience to the U.S., as drivers in Europe are more accustomed to interacting with bicyclists.

5.4 Crash Prediction Models

Crash prediction models have not been developed for U.S. roundabouts.

Crash prediction models have been developed for signalized intersections in the U.S., as discussed previously in Chapter 3. However, no crash prediction models exist yet for U.S. roundabouts and driver behavior. Given the relatively recent introduction of roundabouts to the U.S. and driver unfamiliarity with them, crash prediction models from other countries should be used cautiously. As reported earlier in Section 5.3, crash statistics vary from country to country, both in terms of magnitude and in terms of collision types. Consequently, the application of a crash prediction model from another country may not accurately predict crash frequencies at U.S. locations. Nonetheless, these crash prediction models from other countries can be useful in understanding the *relative* effects of various geometric features on the number of crashes that might be expected. The user is thus cautioned to use these models only for comparative purposes and for obtaining insights into the refinement of individual geometric elements, not to use them for predicting *absolute* numbers of crashes under U.S. conditions.

Crash models relating crash frequency to roundabout characteristics are available from the United Kingdom. The sample consisted of 84 four-leg roundabouts of all sizes, small to large and with various number of approach lanes and entry lanes (flared or parallel entries) (1). Approach speeds were also evenly represented between 48 to 64 km/h (30 to 40 mph) and 80 to 113 km/h (50 to 70 mph). Crash data were collected for periods of 4 to 6 years, a total of 1,427 fatal, serious, and slight injuries only. The proportion of crashes with one casualty was 83.7 percent, and those with two casualties was 12.5 percent. The models are based on generalized linear regression of the exponential form, which assumes a Poisson distribution. Their goodness of fit is expressed in terms of scaled deviations that are moderately reliable. No additional variables, other than those listed below, could further improve the models significantly (see also (8)).

The British crash prediction equations (1), for each type of crash are listed in Equations 5-1 through 5-5. Note that these equations are only valid for roundabouts with four legs. However, the use of these models for relative comparisons may still be reasonable.

Entry-Circulating: (5-1)

$$A = 0.052Q_e^{0.7}Q_c^{0.4} \exp(-40C_e + 0.14e - 0.007ev - \frac{1}{1 + \exp(4R - 7)} + 0.2P_m - 0.01\theta)$$

where: A = personal injury crashes (including fatalities) per year per roundabout approach;

Q_e = entering flow (1,000s of vehicles/day)

Q_c = circulating flow (1,000s of vehicles/day)

C_e = entry curvature = $1/R_e$

e = entry width (m)

v = approach width (m)

R = ratio of inscribed circle diameter/central island diameter

P_m = proportion of motorcycles (%)

θ = angle to next leg, measured centerline to centerline (degrees)

$$\text{Approaching: } A = 0.0057Q_e^{1.7} \exp(20C_e - 0.1e) \quad (5-2)$$

where: A = personal injury crashes (including fatalities) per year at roundabout approach or leg;

Q_e = entering flow (1,000s of vehicles/day)

C_e = entry curvature = $1/R_e$

R_e = entry path radius for the shortest vehicle path (m)

e = entry width (m)

$$\text{Single Vehicle: } A = 0.0064Q_e^{0.8} \exp(25C_e + 0.2v - 45C_a) \quad (5-3)$$

where: A = personal injury crashes (including fatalities) per year at roundabout approach or leg

Q_e = entering flow (1,000s of vehicles/day)

C_e = entry curvature = $1/R_e$

R_e = entry path radius for the shortest vehicle path (m)

V = approach width (m)

C_a = approach curvature = $1/R_a$

R_a = approach radius (m), defined as the radius of a curve between 50 m (164 ft) and 500 m (1,640 ft) of the yield line

$$\text{Other (Vehicle): } A = 0.0064Q_e^{0.8} \exp(25C_e + 0.2v - 45C_a) \quad (5-4)$$

where: A = personal injury crashes (including fatalities) per year at roundabout approach or leg

Q_{ec} = product $Q_e \cdot Q_c$

Q_e = entering flow (1,000s of vehicles/day)

Q_c = circulating flow (1,000s of vehicles/day)

P_m = proportion of motorcycles

$$\text{Pedestrian: } A = 0.029Q_{ep}^{0.5} \quad (5-5)$$

where: A = personal injury crashes (including fatalities) per year at roundabout approach or leg

Q_{ep} = product $(Q_e + Q_{ex}) \cdot Q_p$

Q_e = entering flow (1,000s of vehicles/day)

Q_{ex} = exiting flow (1,000s of vehicles/day)

Q_p = pedestrian crossing flow (1,000s of pedestrians/day)

According to the U.K. crash models, the major physical factors that were statistically significant are entry width, circulatory width, entry path radius, approach curvature, and angle between entries. Some of the effects of these parameters are as follows:

- **Entry width:** For a total entry flow of 20,000 vehicles per day, widening an entry from one lane to two lanes is expected to cause 30 percent more injury crashes. At 40,000 vehicles per day, widening an entry from two lanes to three lanes will cause a 15 percent rise in injury crashes. Moreover, the models could not take into account the added hazard to bicyclists and pedestrians who will have to travel longer exposed distances. (8)

Maximize angles between entries.

- *Circulatory width:* Widening the circulatory roadway has less impact on crashes than entry width. Crashes are expected to rise about 5 percent for a widening of two meters. (8)
- *Entry path radius:* Entry-circulating collision type increases with entry path radius (for the fastest path), while single vehicle and approach collision types decrease. For a double-lane approach, an optimum entry path radius is 50 to 70 m (165 to 230 ft). (8)
- *Approach curvature:* Approach curvature is safer when the approach curve is to the right and less so when the curve is to the left. This implies that a design is slightly safer when reverse curves are provided to gradually slow drivers before entry. For a double-lane approach roundabout with entering flow of 50,000 vehicles per day, changing a straight approach to a right-turning curve of 200 m (650 ft) radius reduces crash frequency by 5 percent. (8)
- *Angle between entries:* As the angle between entries decreases, the frequency of crashes increases. For example, an approach with an angle of 60 degrees to the next leg of the roundabout increases crash frequency by approximately 35 percent over approaches at 90-degree angles. Therefore, the angle between entries should be maximized to improve safety.

An approach suggested in Australia (13) differs from the British approach in that the independent variables are based on measures related to driver behavior. For instance, the collision rate for single vehicle crashes was found to be:

$$A_{sp} = 1.64 \times 10^{-12} \times Q^{1.17} \times L \times (S + \Delta S)^{4.12} / R^{1.91} \quad (5-6)$$

and

$$A_{sa} = 1.79 \times 10^{-9} \times Q^{0.91} \times L \times (S + \Delta S)^{1.93} / R^{0.65} \quad (5-7)$$

where: A_{sp} = the number of single vehicle crashes per year per leg for vehicle path segments prior to the yield line.

A_{sa} = the number of single vehicle crashes per year per leg for vehicle path segments after the yield line.

Q = the average annual daily traffic in the direction considered—one way traffic only (veh/d)

L = the length of the driver's path on the horizontal geometric element (m).

S = the 85th-percentile speed on the horizontal geometric element (km/h).

ΔS = the decrease in the 85th-percentile speed at the start on the horizontal geometric element (km/h). This indicates the speed change from the previous geometric element.

R = the vehicle path radius on the geometric element (m).

These equations demonstrate a direct relationship between the number of crashes, overall speed magnitudes, and the change in speed between elements. Therefore, this equation can be used to estimate the *relative* differences in safety benefits between various geometric configurations by estimating vehicle speeds through the various parts of a roundabout.

5.5 References

1. Maycock, G., and R.D. Hall. *Crashes at four-arm roundabouts*. TRRL Laboratory Report LR 1120. Crowthorne, England: Transport and Road Research Laboratory, 1984.
2. Garder, P. *The Modern Roundabouts: The Sensible Alternative for Maine*. Maine Department of Transportation, Bureau of Planning, Research and Community Services, Transportation Research Division, 1998.
3. Brilon, W. and B. Stuwé. "Capacity and Design of Traffic Circles in Germany." In *Transportation Research Record 1398*. Washington, D.C.: Transportation Research Board, National Research Council, 1993.
4. Schoon, C.C., and J. van Minnen. *Accidents on Roundabouts: II. Second study into the road hazard presented by roundabouts, particularly with regard to cyclists and moped riders*. R-93-16. The Netherlands: SWOV Institute for Road Safety Research, 1993.
5. Flannery, A. and T.K. Datta. "Modern Roundabouts and Traffic Crash Experience in the United States." In *Transportation Research Record 1553*. Washington, D.C.: Transportation Research Board, National Research Council, 1996.
6. Brown, M. *TRL State of the Art Review—The Design of Roundabouts*. London: HMSO, 1995.
7. Alphand, F., U. Noelle, and B. Guichet. "Roundabouts and Road Safety: State of the Art in France." In *Intersections without Traffic Signals II*, Springer-Verlag, Germany (W. Brilon, ed.), 1991, pp. 107–125.
8. Bared, J.G., and K. Kennedy. "Safety Impacts of Modern Roundabouts," Chapter 28, *The Traffic Safety Toolbox: A Primer on Traffic Safety*, Institute of Transportation Engineers, 2000.
9. Jacquemart, G. *Synthesis of Highway Practice 264: Modern Roundabout Practice in the United States*. National Cooperative Highway Research Program. Washington, D.C: National Academy Press, 1998.
10. Brilon, W. and L. Bondzio. White Paper: Summary of International Statistics on Roundabout Safety (unpublished), July 1998.
11. Guichet, B. "Roundabouts In France: Development, Safety, Design, and Capacity." In *Proceedings of the Third International Symposium on Intersections Without Traffic Signals* (M. Kyte, ed.), Portland, Oregon, U.S.A. University of Idaho, 1997.
12. Centre d'Etude des Transports Urbains (CETUR). "Safety of Roundabouts in Urban and Suburban Areas." Paris, 1992.
13. Arndt, O. "Road Design Incorporating Three Fundamental Safety Parameters." Technology Transfer Forum 5 and 6, Transport Technology Division, Main Roads Department, Queensland, Australia, August 1998.
14. SETRA/CETE de l'Ouest. "Safety Concerns on Roundabouts." 1998.

15. Crown, B. "An Introduction to Some Basic Principles of U.K. Roundabout Design." Presented at the ITE District 6 Conference on Roundabouts, Loveland, Colorado, October 1998.
16. Seim, K. "Use, Design and Safety of Small Roundabouts in Norway." In "Intersections Without Traffic Signals II", Springer-Verlag, Germany (W. Brilon, ed.), 1991, pp.270–281.
17. Van Minnen, J. "Safety of Bicyclists on Roundabouts Deserves Special Attention." SWOV Institute of Road Safety Research in the Netherlands, Research Activities 5, March 1996.
18. Brude, U., and J. Larsson. *The Safety of Cyclists at Roundabouts—A Comparison Between Swedish, Danish and Dutch Results*. Swedish National Road and Transport Research Institute (VTI), Nordic Road & Transport Research No. 1, 1997.



Geometric Design

6.1	Introduction	130
6.1.1	Geometric elements	130
6.1.2	Design process	130
6.2	General Design Principles	132
6.2.1	Speeds through the roundabout	132
6.2.2	Design vehicle	142
6.2.3	Nonmotorized design users	144
6.2.4	Alignment of approaches and entries	144
6.3	Geometric Elements	145
6.3.1	Inscribed circle diameter	145
6.3.2	Entry width	147
6.3.3	Circulatory roadway width	149
6.3.4	Central island	150
6.3.5	Entry curves	152
6.3.6	Exit curves	154
6.3.7	Pedestrian crossing location and treatments	155
6.3.8	Splitter islands	157
6.3.9	Stopping sight distance	159
6.3.10	Intersection sight distance	161
6.3.11	Vertical considerations	164
6.3.12	Bicycle provisions	167

6.3.13	Sidewalk treatments	168
6.3.14	Parking considerations and bus stop locations	169
6.3.15	Right-turn bypass lanes	170
6.4	Double-Lane Roundabouts	172
6.4.1	The natural vehicle path	172
6.4.2	Vehicle path overlap	174
6.4.3	Design method to avoid path overlap	174
6.5	Rural Roundabouts	176
6.5.1	Visibility	177
6.5.2	Curbing	177
6.5.3	Splitter islands	177
6.5.4	Approach curves	178
6.6	Mini-Roundabouts	179
6.7	References	181
Exhibit 6-1.	Basic geometric elements of a roundabout.	131
Exhibit 6-2.	Roundabout design process.	131
Exhibit 6-3.	Sample theoretical speed profile (urban compact roundabout).	133
Exhibit 6-4.	Recommended maximum entry design speeds.	133
Exhibit 6-5.	Fastest vehicle path through single-lane roundabout.	134
Exhibit 6-6.	Fastest vehicle path through double-lane roundabout.	135
Exhibit 6-7.	Example of critical right-turn movement.	135
Exhibit 6-8.	Side friction factors at various speeds (metric units).	137
Exhibit 6-9.	Side friction factors at various speeds (U.S. customary units).	137
Exhibit 6-10.	Speed-radius relationship (metric units).	138
Exhibit 6-11.	Speed-radius relationship (U.S. customary units).	138
Exhibit 6-12.	Vehicle path radii.	139
Exhibit 6-13.	Approximated R_4 values and corresponding R_1 values (metric units).	141
Exhibit 6-14.	Approximated R_4 values and corresponding R_1 values (U.S. customary units).	141
Exhibit 6-15.	Through-movement swept path of WB-15 (WB-50) vehicle.	143
Exhibit 6-16.	Left-turn and right-turn swept paths of WB-15 (WB-50) vehicle.	143
Exhibit 6-17.	Key dimensions of nonmotorized design users.	144
Exhibit 6-18.	Radial alignment of entries.	145
Exhibit 6-19.	Recommended inscribed circle diameter ranges.	146
Exhibit 6-20.	Approach widening by adding full lane.	148

Exhibit 6-21.	Approach widening by entry flaring.	148
Exhibit 6-22.	Minimum circulatory lane widths for two-lane roundabouts.	150
Exhibit 6-23.	Example of central island with a traversable apron.	151
Exhibit 6-24.	Single-lane roundabout entry design.	153
Exhibit 6-25.	Single-lane roundabout exit design.	154
Exhibit 6-26.	Minimum splitter island dimensions.	157
Exhibit 6-27.	Minimum splitter island nose radii and offsets.	158
Exhibit 6-28.	Design values for stopping sight distances.	159
Exhibit 6-29.	Approach sight distance.	160
Exhibit 6-30.	Sight distance on circulatory roadway.	160
Exhibit 6-31.	Sight distance to crosswalk on exit.	161
Exhibit 6-32.	Intersection sight distance.	162
Exhibit 6-33.	Computed length of conflicting leg of intersection sight triangle.	163
Exhibit 6-34.	Sample plan view.	164
Exhibit 6-35.	Sample approach profile.	165
Exhibit 6-36.	Sample central island profile.	165
Exhibit 6-37.	Typical circulatory roadway section.	166
Exhibit 6-38.	Typical section with a truck apron.	166
Exhibit 6-39.	Possible provisions for bicycles.	168
Exhibit 6-40.	Sidewalk treatments.	169
Exhibit 6-41.	Example of right-turn bypass lane.	170
Exhibit 6-42.	Configuration of right-turn bypass lane with acceleration lane.	171
Exhibit 6-43.	Configuration of right-turn bypass lane with yield at exit leg.	172
Exhibit 6-44.	Sketched natural paths through a double-lane roundabout.	173
Exhibit 6-45.	Path overlap at a double-lane roundabout.	174
Exhibit 6-46.	One method of entry design to avoid path overlap at double-lane roundabouts.	175
Exhibit 6-47.	Alternate method of entry design to avoid path overlap at double-lane roundabouts.	175
Exhibit 6-48.	Extended splitter island treatment.	178
Exhibit 6-49.	Use of successive curves on high speed approaches.	179
Exhibit 6-50.	Example of mini-roundabout.	180

Chapter 6 Geometric Design

6.1 Introduction

Roundabout design involves trade-offs among safety, operations, and accommodating large vehicles.

Designing the geometry of a roundabout involves choosing between trade-offs of safety and capacity. Roundabouts operate most safely when their geometry forces traffic to enter and circulate at slow speeds. Horizontal curvature and narrow pavement widths are used to produce this reduced-speed environment. Conversely, the capacity of roundabouts is negatively affected by these low-speed design elements. As the widths and radii of entry and circulatory roadways are reduced, so also the capacity of the roundabout is reduced. Furthermore, many of the geometric parameters are governed by the maneuvering requirements of the largest vehicles expected to travel through the intersection. Thus, designing a roundabout is a process of determining the optimal balance between safety provisions, operational performance, and large vehicle accommodation.

Some roundabout features are uniform, while others vary depending on the location and size of the roundabout.

While the basic form and features of roundabouts are uniform regardless of their location, many of the design techniques and parameters are different, depending on the speed environment and desired capacity at individual sites. In rural environments where approach speeds are high and bicycle and pedestrian use may be minimal, the design objectives are significantly different from roundabouts in urban environments where bicycle and pedestrian safety are a primary concern. Additionally, many of the design techniques are substantially different for single-lane roundabouts than for roundabouts with multiple entry lanes.

This chapter is organized so that the fundamental design principles common among all roundabout types are presented first. More detailed design considerations specific to multilane roundabouts, rural roundabouts, and mini-roundabouts are given in subsequent sections of the chapter.

6.1.1 Geometric elements

Exhibit 6-1 provides a review of the basic geometric features and dimensions of a roundabout. Chapter 1 provided the definitions of these elements.

6.1.2 Design process

Roundabout design is an iterative process.

The process of designing roundabouts, more so than other forms of intersections, requires a considerable amount of iteration among geometric layout, operational analysis, and safety evaluation. As described in Chapters 4 and 5, minor adjustments in geometry can result in significant changes in the safety and/or operational performance. Thus, the designer often needs to revise and refine the initial layout attempt to enhance its capacity and safety. It is rare to produce an optimal geometric design on the first attempt. Exhibit 6-2 provides a graphical flowchart for the process of designing and evaluating a roundabout.

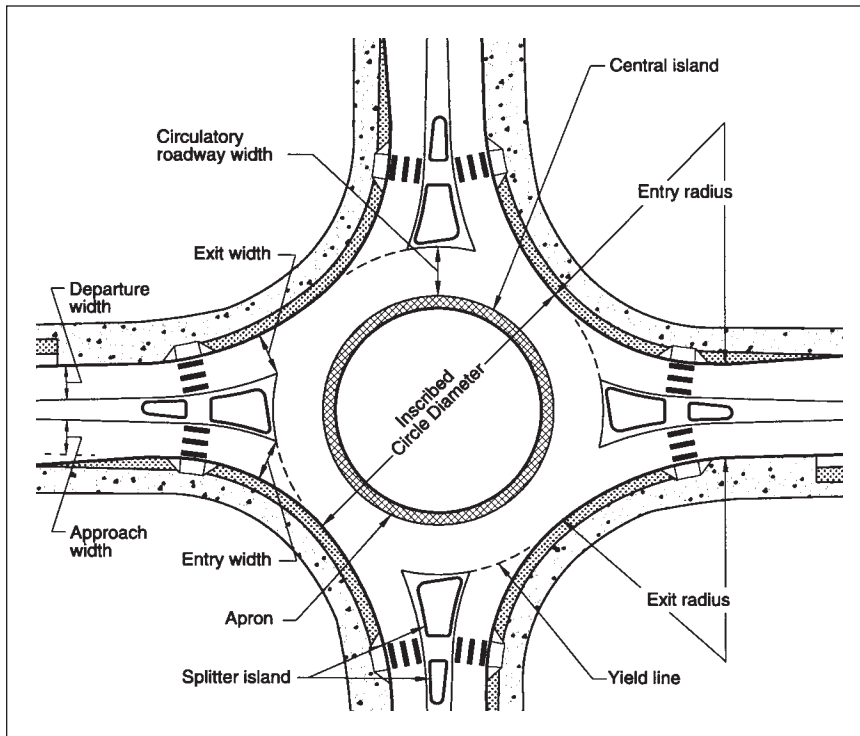

Exhibit 6-1. Basic geometric elements of a roundabout.

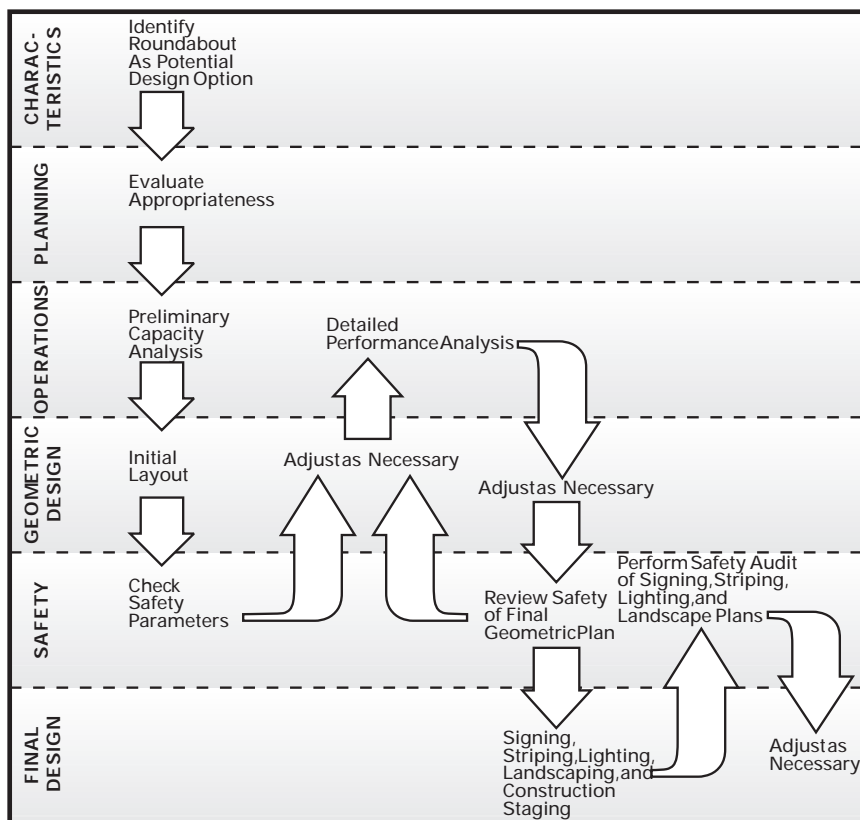

Exhibit 6-2. Roundabout design process.

Because roundabout design is such an iterative process, in which small changes in geometry can result in substantial changes to operational and safety performance, it may be advisable to prepare the initial layout drawings at a sketch level of detail. Although it is easy to get caught into the desire to design each of the individual components of the geometry such that it complies with the specifications provided in this chapter, it is much more important that the individual components are compatible with each other so that the roundabout will meet its overall performance objectives. Before the details of the geometry are defined, three fundamental elements must be determined in the preliminary design stage:

1. The optimal roundabout size;
2. The optimal position; and
3. The optimal alignment and arrangement of approach legs.

6.2 General Design Principles

This section describes the fundamental design principles common among all categories of roundabouts. Guidelines for the design of each geometric element are provided in the following section. Further guidelines specific to double-lane roundabouts, rural roundabouts, and mini-roundabouts are given in subsequent sections. Note that double-lane roundabout design is significantly different from single-lane roundabout design, and many of the techniques used in single-lane roundabout design do not directly transfer to double-lane design.

6.2.1 Speeds through the roundabout

Because it has profound impacts on safety, achieving appropriate vehicular speeds through the roundabout is the most critical design objective. A well-designed roundabout reduces the relative speeds between conflicting traffic streams by requiring vehicles to negotiate the roundabout along a curved path.

6.2.1.1 Speed profiles

Exhibit 6-3 shows the operating speeds of typical vehicles approaching and negotiating a roundabout. Approach speeds of 40, 55, and 70 km/h (25, 35, and 45 mph, respectively) about 100 m (325 ft) from the center of the roundabout are shown. Deceleration begins before this time, with circulating drivers operating at approximately the same speed on the roundabout. The relatively uniform negotiation speed of all drivers on the roundabout means that drivers are able to more easily choose their desired paths in a safe and efficient manner.

6.2.1.2 Design speed

International studies have shown that increasing the vehicle path curvature decreases the relative speed between entering and circulating vehicles and thus usually results in decreases in the entering-circulating and exiting-circulating vehicle crash rates. However, at multilane roundabouts, increasing vehicle path curvature creates greater side friction between adjacent traffic streams and can result in more vehicles cutting across lanes and higher potential for sideswipe crashes (2). Thus, for each roundabout, there exists an optimum design speed to minimize crashes.

The most critical design objective is achieving appropriate vehicular speeds through the roundabout.

Increasing vehicle path curvature decreases relative speeds between entering and circulating vehicles, but also increases side friction between adjacent traffic streams in multilane roundabouts.

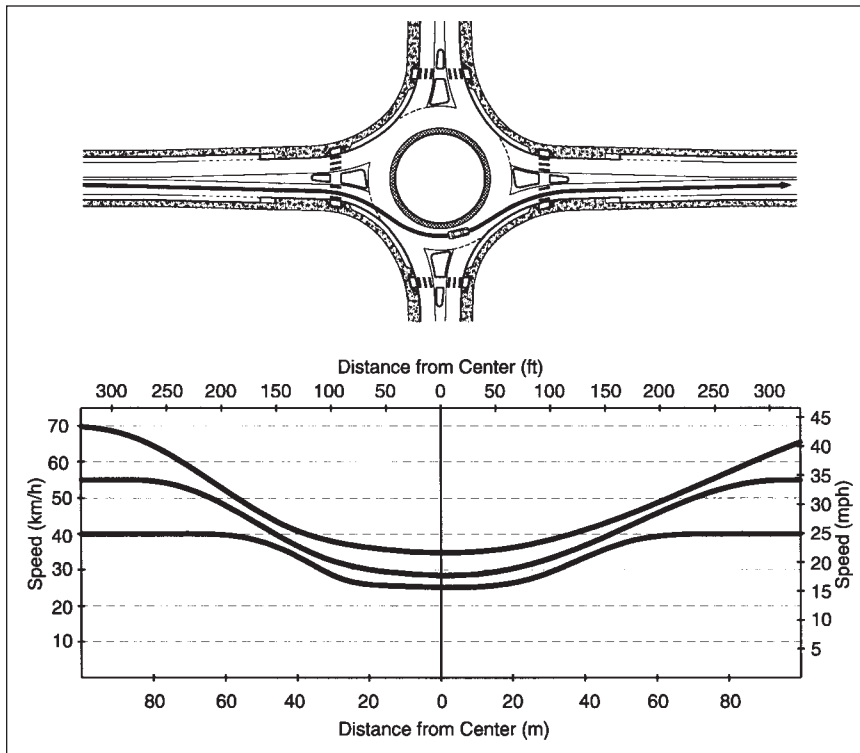

Exhibit 6-3. Sample theoretical speed profile (urban compact roundabout).

Recommended maximum entry design speeds for roundabouts at various intersection site categories are provided in Exhibit 6-4.

Site Category	Recommended Maximum Entry Design Speed
Mini-Roundabout	25 km/h (15 mph)
Urban Compact	25 km/h (15 mph)
Urban Single Lane	35 km/h (20 mph)
Urban Double Lane	40 km/h (25 mph)
Rural Single Lane	40 km/h (25 mph)
Rural Double Lane	50 km/h (30 mph)

Exhibit 6-4. Recommended maximum entry design speeds.

6.2.1.3 Vehicle paths

Roundabout speed is determined by the fastest path allowed by the geometry.

To determine the speed of a roundabout, the fastest path allowed by the geometry is drawn. This is the smoothest, flattest path possible for a single vehicle, in the absence of other traffic and ignoring all lane markings, traversing through the entry, around the central island, and out the exit. Usually the fastest possible path is the through movement, but in some cases it may be a right turn movement.

A vehicle is assumed to be 2 m (6 ft) wide and to maintain a minimum clearance of 0.5 m (2 ft) from a roadway centerline or concrete curb and flush with a painted edge line (2). Thus the centerline of the vehicle path is drawn with the following distances to the particular geometric features:

- 1.5 m (5 ft) from a concrete curb,
- 1.5 m (5 ft) from a roadway centerline, and
- 1.0 m (3 ft) from a painted edge line.

Through movements are usually the fastest path, but sometimes right turn paths are more critical.

Exhibits 6-5 and 6-6 illustrate the construction of the fastest vehicle paths at a single-lane roundabout and at a double-lane roundabout, respectively. Exhibit 6-7 provides an example of an approach at which the right-turn path is more critical than the through movement.

Exhibit 6-5. Fastest vehicle path through single-lane roundabout.

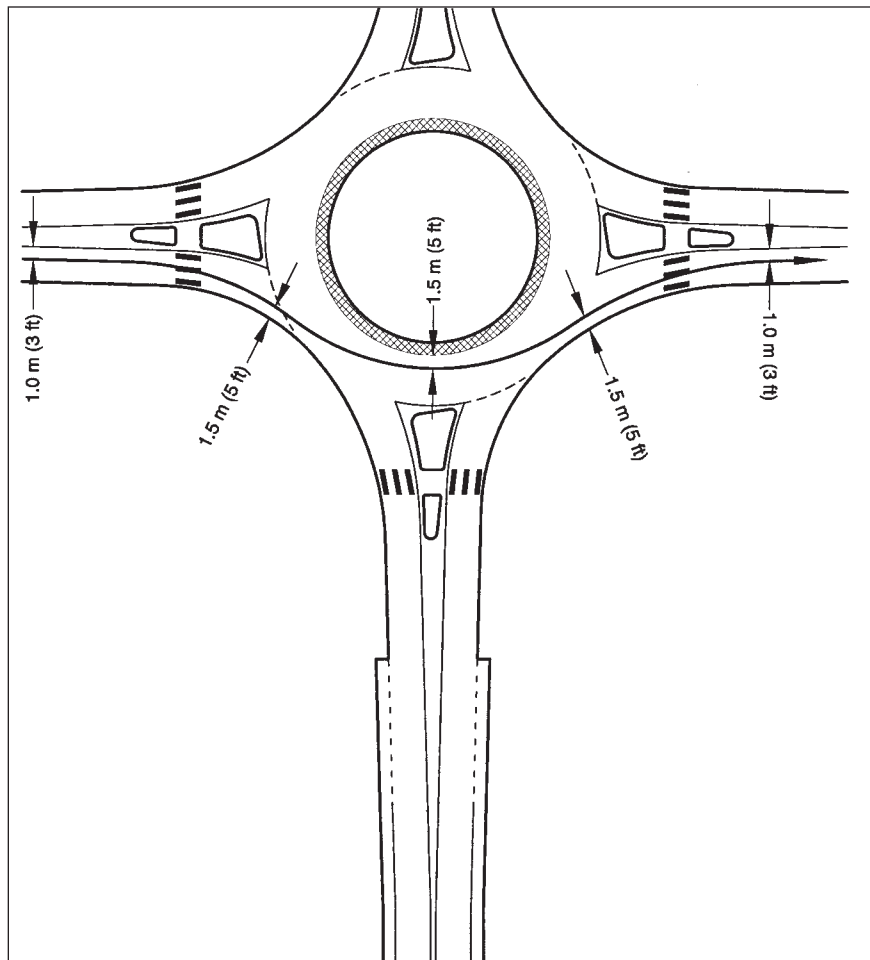

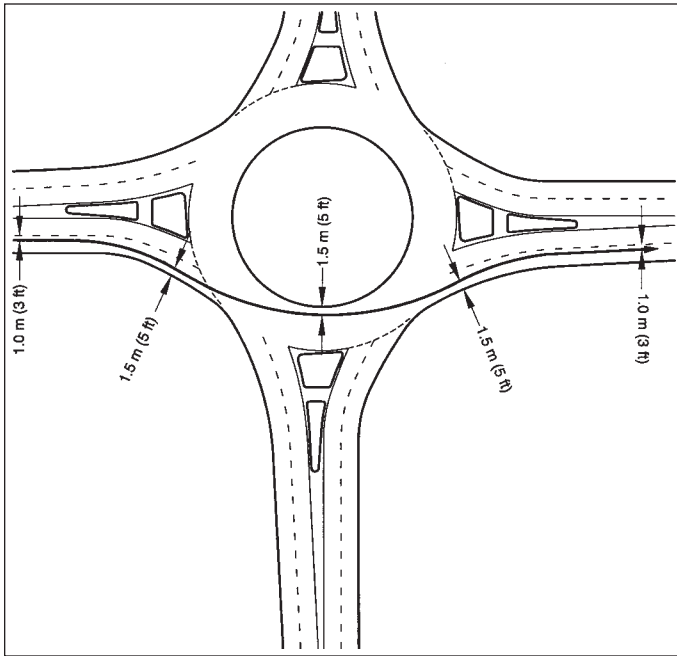

Exhibit 6-6. Fastest vehicle path through double-lane roundabout.

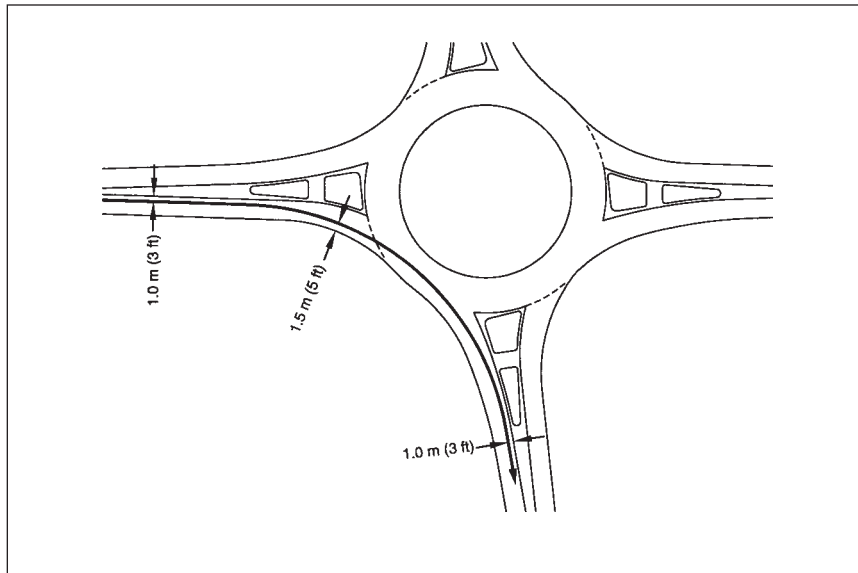

Exhibit 6-7. Example of critical right-turn movement.

As shown in Exhibits 6-5 and 6-6, the fastest path for the through movement is a series of reverse curves (i.e., a curve to the right, followed by a curve to the left, followed by a curve to the right). When drawing the path, a short length of tangent should be drawn between consecutive curves to account for the time it takes for a driver to turn the steering wheel. It may be initially better to draw the path free-hand, rather than using drafting templates or a computer-aided design (CAD) program. The freehand technique may provide a more natural representation of the way a driver negotiates the roundabout, with smooth transitions connecting curves and tangents. Having sketched the fastest path, the designer can then measure the minimum radii using suitable curve templates or by replicating the path in CAD and using it to determine the radii.

The entry path radius should not be significantly larger than the circulatory radius.

The design speed of the roundabout is determined from the smallest radius along the fastest allowable path. The smallest radius usually occurs on the circulatory roadway as the vehicle curves to the left around the central island. However, it is important when designing the roundabout geometry that the radius of the entry path (i.e., as the vehicle curves to the right through entry geometry) not be significantly larger than the circulatory path radius.

Draw the fastest path for all roundabout approaches.

The fastest path should be drawn for all approaches of the roundabout. Because the construction of the fastest path is a subjective process requiring a certain amount of personal judgment, it may be advisable to obtain a second opinion.

6.2.1.4 Speed-curve relationship

The relationship between travel speed and horizontal curvature is documented in the American Association of State Highway and Transportation Officials' document, A Policy on Geometric Design of Highways and Streets, commonly known as the Green Book (4). Equation 6-1 can be used to calculate the design speed for a given travel path radius.

$$V = \sqrt{127R(e+f)} \quad (6-1a, \text{ metric}) \qquad V = \sqrt{15R(e+f)} \quad (6-1b, \text{ U.S. customary})$$

where: V = Design speed, km/h
 R = Radius, m
 e = superelevation, m/m
 f = side friction factor

where: V = Design speed, mph
 R = Radius, ft
 e = superelevation, ft/ft
 f = side friction factor

Superelevation values are usually assumed to be +0.02 for entry and exit curves and -0.02 for curves around the central island. For more details related to superelevation design, see Section 6.3.11.

Values for side friction factor can be determined in accordance with the AASHTO relation for curves at intersections (see 1994 AASHTO Figure III-19 (4)). The coefficient of friction between a vehicle's tires and the pavement varies with the vehicle's speed, as shown in Exhibits 6-8 and 6-9 for metric and U.S. customary units, respectively.

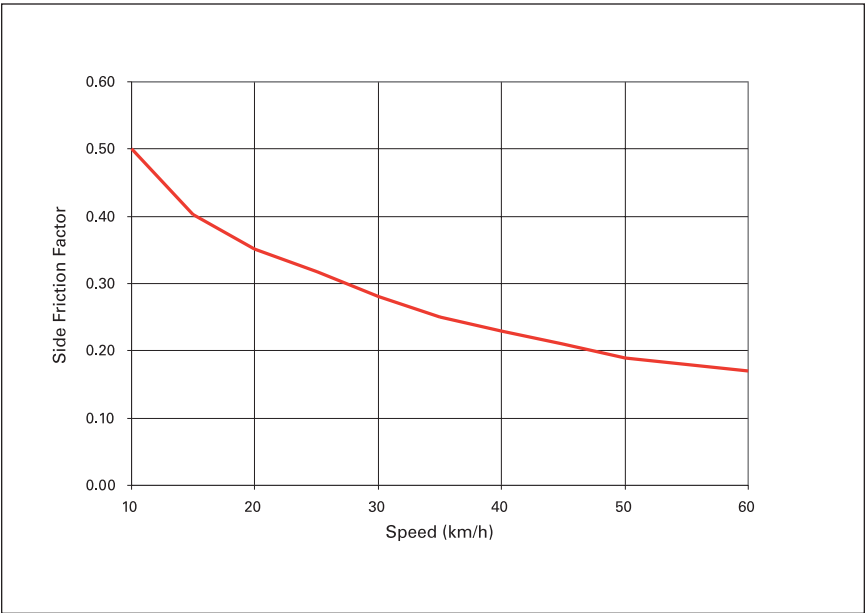

Exhibit 6-8. Side friction factors at various speeds (metric units).

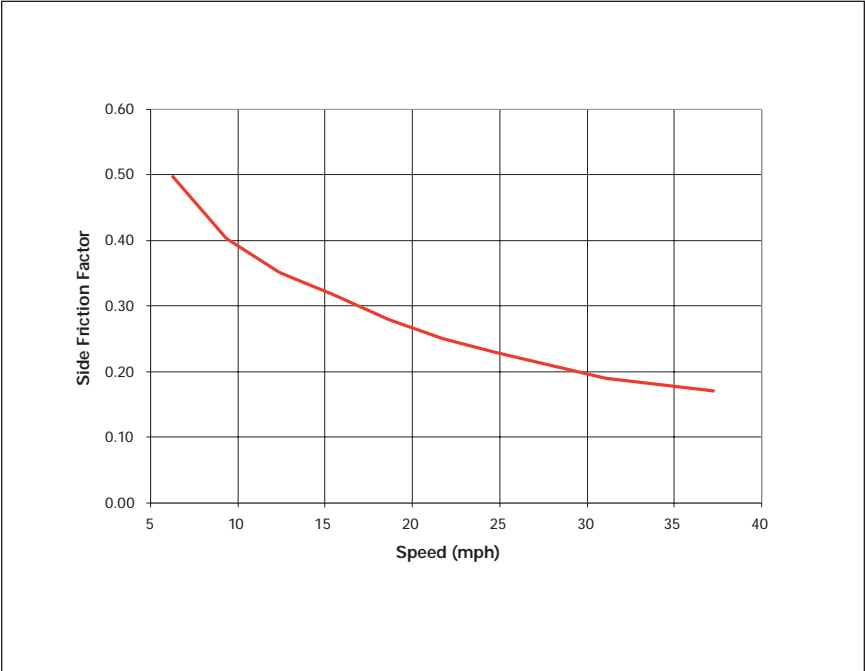

Exhibit 6-9. Side friction factors at various speeds (U.S. customary units).

Using the appropriate friction factors corresponding to each speed, Exhibits 6-10 and 6-11 present charts in metric and U.S. customary units, respectively, showing the speed-radius relationship for curves for both a +0.02 superelevation and -0.02 superelevation.

Exhibit 6-10. Speed-radius relationship (metric units).

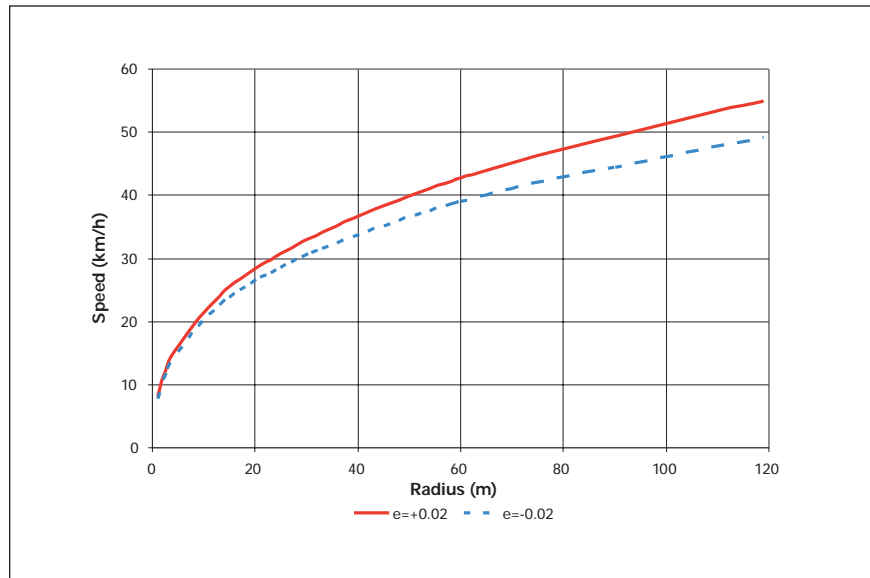
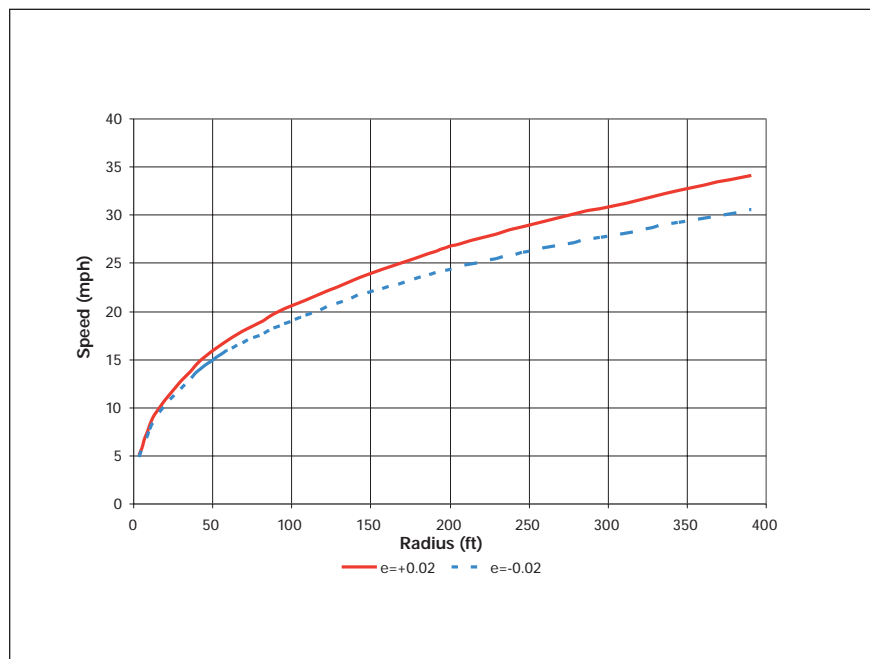

Exhibit 6-11. Speed-radius relationship (U.S. customary units.)



6.2.15 Speed consistency

In addition to achieving an appropriate design speed for the fastest movements, another important objective is to achieve consistent speeds for all movements. Along with overall reductions in speed, speed consistency can help to minimize the crash rate and severity between conflicting streams of vehicles. It also simplifies the task of merging into the conflicting traffic stream, minimizing critical gaps, thus optimizing entry capacity. This principle has two implications:

1. The relative speeds between consecutive geometric elements should be minimized; and
2. The relative speeds between conflicting traffic streams should be minimized.

As shown in Exhibit 6-12, five critical path radii must be checked for each approach. R_1 , the *entry path radius*, is the minimum radius on the fastest through path prior to the yield line. R_2 , the *circulating path radius*, is the minimum radius on the fastest through path around the central island. R_3 , the *exit path radius*, is the minimum radius on the fastest through path into the exit. R_4 , the *left-turn path radius*, is the minimum radius on the path of the conflicting left-turn movement. R_5 , the *right-turn path radius*, is the minimum radius on the fastest path of a right-turning vehicle. It is important to note that these vehicular path radii are not the same as the curb radii. First the basic curb geometry is laid out, and then the vehicle paths are drawn in accordance with the procedures described in Section 6.2.1.3.

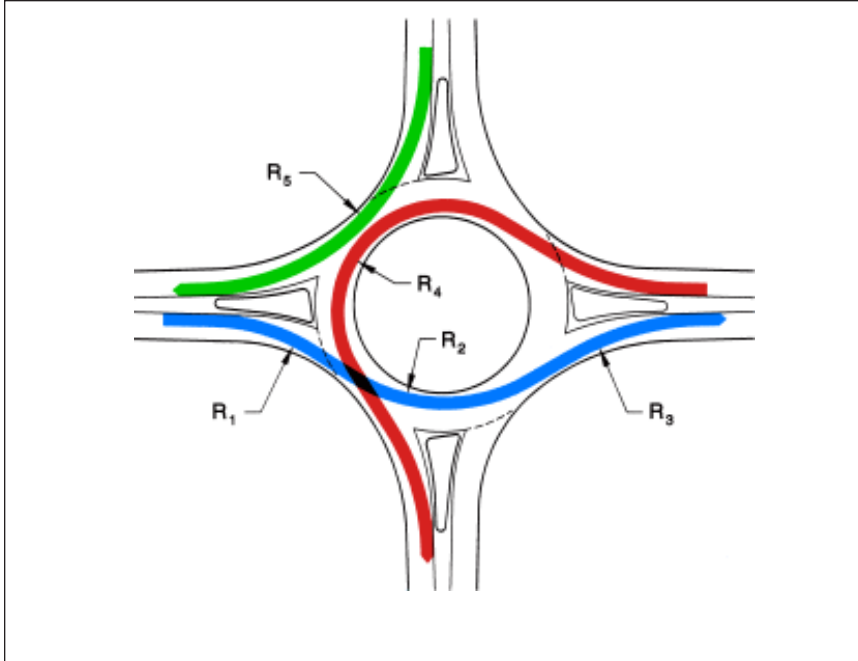

Exhibit 6-12. Vehicle path radii.

On the fastest path, it is desirable for R_1 to be smaller than R_2 , which in turn should be smaller than R_3 . This ensures that speeds will be reduced to their lowest level at the roundabout entry and will thereby reduce the likelihood of loss-of-control crashes. It also helps to reduce the speed differential between entering and circulating traffic, thereby reducing the entering-circulating vehicle crash rate. However, in some cases it may not be possible to achieve an R_1 value less than R_2 within given right-of-way or topographic constraints. In such cases, it is acceptable for R_1 to be greater than R_2 , provided the relative difference in speeds is less than 20 km/h (12 mph) and preferably less than 10 km/h (6 mph).

The *natural path* of a vehicle is the path that a driver would take in the absence of other conflicting vehicles.

At single-lane roundabouts, it is relatively simple to reduce the value of R_1 . The curb radius at the entry can be reduced or the alignment of the approach can be shifted further to the left to achieve a slower entry speed (with the potential for higher exit speeds that may put pedestrians at risk). However, at double-lane roundabouts, it is generally more difficult as overly small entry curves can cause the *natural path* of adjacent traffic streams to overlap. Path overlap happens when the geometry leads a vehicle in the left approach lane to naturally sweep across the right approach lane just before the approach line to avoid the central island. It may also happen within the circulatory roadway when a vehicle entering from the right-hand lane naturally cuts across the left side of the circulatory roadway close to the central island. When path overlap occurs at double-lane roundabouts, it may reduce capacity and increase crash risk. Therefore, care must be taken when designing double-lane roundabouts to achieve ideal values for R_1 , R_2 , and R_3 . Section 6.4 provides further guidance on eliminating path overlap at double-lane roundabouts.

The exit radius, R_3 , should not be less than R_1 or R_2 in order to minimize loss-of-control crashes. At single-lane roundabouts with pedestrian activity, exit radii may still be small (the same or slightly larger than R_2) in order to minimize exit speeds. However, at double-lane roundabouts, additional care must be taken to minimize the likelihood of exiting path overlap. Exit path overlap can occur at the exit when a vehicle on the left side of the circulatory roadway (next to the central island) exits into the right-hand exit lane. Where no pedestrians are expected, the exit radii should be just large enough to minimize the likelihood of exiting path overlap. Where pedestrians are present, tighter exit curvature may be necessary to ensure sufficiently low speeds at the downstream pedestrian crossing.

The radius of the conflicting left-turn movement, R_4 , must be evaluated in order to ensure that the maximum speed differential between entering and circulating traffic is no more than 20 km/h (12 mph). The left-turn movement is the critical traffic stream because it has the lowest circulating speed. Large differentials between entry and circulating speeds may result in an increase in single-vehicle crashes due to loss of control. Generally, R_4 can be determined by adding 1.5 m (5 ft) to the central island radius. Based on this assumption, Exhibits 6-13 and 6-14 show approximate R_4 values and corresponding maximum R_1 values for various inscribed circle diameters in metric and U.S. customary units, respectively.

Finally, the radius of the fastest possible right-turn path, R_5 , is evaluated. Like R_1 , the right-turn radius should have a design speed at or below the maximum design speed of the roundabout and no more than 20 km/h (12 mph) above the conflicting R_4 design speed.

Inscribed Circle Diameter (m)	Approximate R_4 Value		Maximum R_1 Value	
	Radius (m)	Speed (km/h)	Radius (m)	Speed (km/h)
Single-Lane Roundabout				
30	11	21	54	41
35	13	23	61	43
40	16	25	69	45
45	19	26	73	46
Double-Lane Roundabout				
45	15	24	65	44
50	17	25	69	45
55	20	27	78	47
60	23	28	83	48
65	25	29	88	49
70	28	30	93	50

Exhibit 6-13. Approximated R_4 values and corresponding R_1 values (metric units).

Inscribed Circle Diameter (m)	Approximate R_4 Value		Maximum R_1 Value	
	Radius (ft)	Speed (mph)	Radius (ft)	Speed (mph)
Single-Lane Roundabout				
100	35	13	165	25
115	45	14	185	26
130	55	15	205	27
150	65	15	225	28
Double-Lane Roundabout				
150	50	15	205	27
165	60	16	225	28
180	65	16	225	28
200	75	17	250	29
215	85	18	275	30
230	90	18	275	30

Exhibit 6-14. Approximated R_4 values and corresponding R_1 values (U.S. customary units).

The design vehicle dictates many of the roundabout's dimensions.

6.2.2 Design vehicle

Another important factor determining a roundabout's layout is the need to accommodate the largest motorized vehicle likely to use the intersection. The turning path requirements of this vehicle, termed hereafter the *design vehicle*, will dictate many of the roundabout's dimensions. Before beginning the design process, the designer must be conscious of the design vehicle and possess the appropriate vehicle turning templates or a CAD-based vehicle turning path program to determine the vehicle's swept path.

The choice of design vehicle will vary depending upon the approaching roadway types and the surrounding land use characteristics. The local or State agency with jurisdiction of the associated roadways should usually be consulted to identify the design vehicle at each site. The AASHTO *A Policy on Geometric Design of Highways and Streets* provides the dimensions and turning path requirements for a variety of common highway vehicles (4). Commonly, WB-15 (WB-50) vehicles are the largest vehicles along collectors and arterials. Larger trucks, such as WB-20 (WB-67) vehicles, may need to be addressed at intersections on interstate freeways or State highway systems. Smaller design vehicles may often be chosen for local street intersections.

In general, larger roundabouts need to be used to accommodate large vehicles while maintaining low speeds for passenger vehicles. However, in some cases, land constraints may limit the ability to accommodate large semi-trailer combinations while achieving adequate deflection for small vehicles. At such times, a truck apron may be used to provide additional traversable area around the central island for large semi-trailers. Truck aprons, though, provide a lower level of operation than standard nonmountable islands and should be used only when there is no other means of providing adequate deflection while accommodating the design vehicle.

Exhibits 6-15 and 6-16 demonstrate the use of a CAD-based computer program to determine the vehicle's swept path through the critical turning movements.

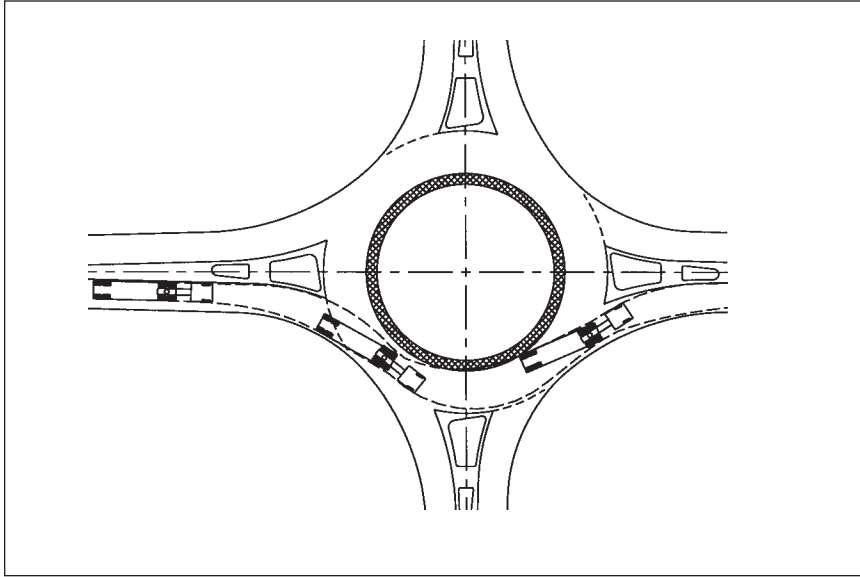

Exhibit 6-15. Through-movement swept path of WB-15 (WB-50) vehicle.

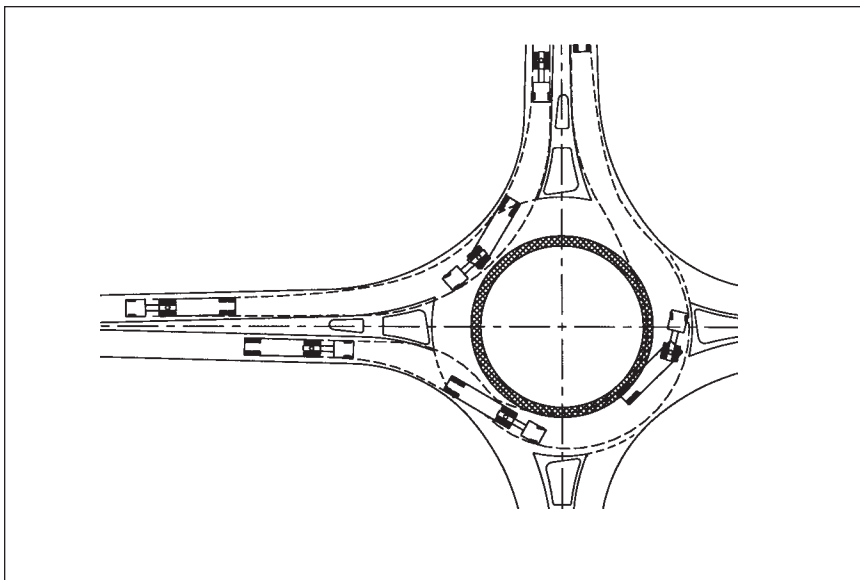

Exhibit 6-16. Left-turn and right-turn swept paths of WB-15 (WB-50) vehicle.

6.2.3 Nonmotorized design users

Like the motorized design vehicle, the design criteria of nonmotorized potential roundabout users (bicyclists, pedestrians, skaters, wheelchair users, strollers, etc.) should be considered when developing many of the geometric elements of a roundabout design. These users span a wide range of ages and abilities that can have a significant effect on the design of a facility.

The basic design dimensions for various design users are given in Exhibit 6-17 (5).

Exhibit 6-17. Key dimensions of nonmotorized design users.

User	Dimension	Affected Roundabout Features
Bicycles		
Length	1.8 m (5.9 ft)	Splitter island width at crosswalk
Minimum operating width	1.5 m (4.9 ft)	Bike lane width
Lateral clearance on each side	0.6 m (2.0 ft); 1.0 m (3.3 ft) to obstructions	Shared bicycle-pedestrian path width
Pedestrian (walking)		
Width	0.5 m (1.6 ft)	Sidewalk width, crosswalk width
Wheelchair		
Minimum width	0.75 m (2.5 ft)	Sidewalk width, crosswalk width
Operating width	0.90 m (3.0 ft)	Sidewalk width, crosswalk width
Person pushing stroller		
Length	1.70 m (5.6 ft)	Splitter island width at crosswalk
Skaters		
Typical operating width	1.8 m (6 ft)	Sidewalk width

Source: (5)

6.2.4 Alignment of approaches and entries

In general, the roundabout is optimally located when the centerlines of all approach legs pass through the center of the inscribed circle. This location usually allows the geometry to be adequately designed so that vehicles will maintain slow speeds through both the entries and the exits. The radial alignment also makes the central island more conspicuous to approaching drivers.

If it is not possible to align the legs through the center point, a slight offset to the left (i.e., the centerline passes to the left of the roundabout's center point) is acceptable. This alignment will still allow sufficient curvature to be achieved at the entry, which is of supreme importance. In some cases (particularly when the inscribed circle is relatively small), it may be beneficial to introduce a slight offset of the approaches to the left in order to enhance the entry curvature. However, care must be taken to ensure that such an approach offset does not produce an excessively tangential exit. Especially in urban environments, it is important that the exit

Roundabouts are optimally located when all approach centerlines pass through the center of the inscribed circle.

geometry produce a sufficiently curved exit path in order to keep vehicle speeds low and reduce the risk for pedestrians.

It is almost never acceptable for an approach alignment to be offset to the right of the roundabout's center point. This alignment brings the approach in at a more tangential angle and reduces the opportunity to provide sufficient entry curvature. Vehicles will be able to enter the roundabout too fast, resulting in more loss-of-control crashes and higher crash rates between entering and circulating vehicles. Exhibit 6-18 illustrates the preferred radial alignment of entries.

Approach alignment should not be offset to the right of the roundabout's center point.

In addition, it is desirable to equally space the angles between entries. This provides optimal separation between successive entries and exits. This results in optimal angles of 90 degrees for four-leg roundabouts, 72 degrees for five-leg roundabouts, and so on. This is consistent with findings of the British accident prediction models described in Chapter 5.

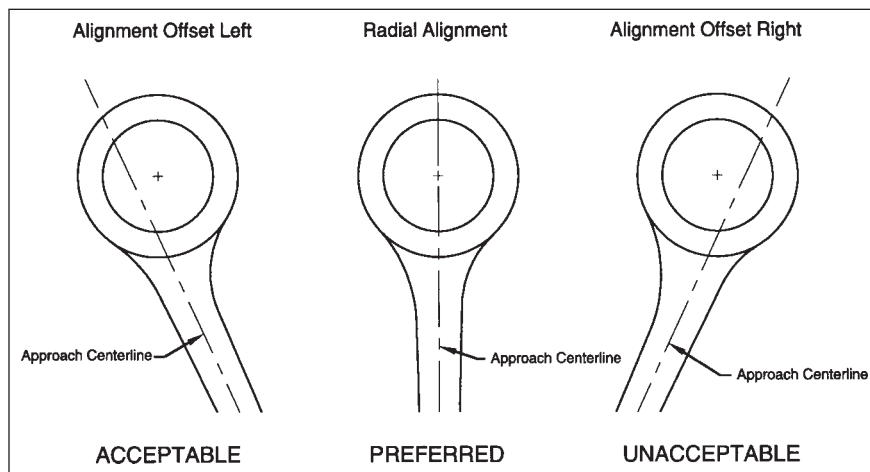

Exhibit 6-18. Radial alignment of entries.

6.3 Geometric Elements

This section presents specific parameters and guidelines for the design of each geometric element of a roundabout. The designer must keep in mind, however, that these components are not independent of each other. The interaction between the components of the geometry is far more important than the individual pieces. Care must be taken to ensure that the geometric elements are all compatible with each other so that the overall safety and capacity objectives are met.

6.3.1 Inscribed circle diameter

The inscribed circle diameter is the distance across the circle inscribed by the outer curb (or edge) of the circulatory roadway. As illustrated in Exhibit 6-1, it is the sum of the central island diameter (which includes the apron, if present) and twice the circulatory roadway. The inscribed circle diameter is determined by a number of design objectives. The designer often has to experiment with varying diameters before determining the optimal size at a given location.

For a single-lane roundabout, the minimum inscribed circle diameter is 30 m (100 ft) to accommodate a WB-15 (WB-50) vehicle.

At single-lane roundabouts, the size of the inscribed circle is largely dependent upon the turning requirements of the design vehicle. The diameter must be large enough to accommodate the design vehicle while maintaining adequate deflection curvature to ensure safe travel speeds for smaller vehicles. However, the circulatory roadway width, entry and exit widths, entry and exit radii, and entry and exit angles also play a significant role in accommodating the design vehicle and providing deflection. Careful selection of these geometric elements may allow a smaller inscribed circle diameter to be used in constrained locations. In general, the inscribed circle diameter should be a *minimum* of 30 m (100 ft) to accommodate a WB-15 (WB-50) design vehicle. Smaller roundabouts can be used for some local street or collector street intersections, where the design vehicle may be a bus or single-unit truck.

For a double-lane roundabout, the minimum inscribed circle diameter is 45 m (150 ft).

At double-lane roundabouts, accommodating the design vehicle is usually not a constraint. The size of the roundabout is usually determined either by the need to achieve deflection or by the need to fit the entries and exits around the circumference with reasonable entry and exit radii between them. Generally, the inscribed circle diameter of a double-lane roundabout should be a *minimum* of 45 m (150 ft).

In general, smaller inscribed diameters are better for overall safety because they help to maintain lower speeds. In high-speed environments, however, the design of the approach geometry is more critical than in low-speed environments. Larger inscribed diameters generally allow for the provision of better approach geometry, which leads to a decrease in vehicle approach speeds. Larger inscribed diameters also reduce the angle formed between entering and circulating vehicle paths, thereby reducing the relative speed between these vehicles and leading to reduced entering-circulating crash rates (2). Therefore, roundabouts in high-speed environments may require diameters that are somewhat larger than those recommended for low-speed environments. Very large diameters (greater than 60 m [200 ft]), however, should generally not be used because they will have high circulating speeds and more crashes with greater severity. Exhibit 6-19 provides recommended ranges of inscribed circle diameters for various site locations.

Exhibit 6-19. Recommended inscribed circle diameter ranges.

Site Category	Typical Design Vehicle	Inscribed Circle Diameter Range*
Mini-Roundabout	Single-Unit Truck	13–25m (45–80 ft)
Urban Compact	Single-Unit Truck/Bus	25–30m (80–100 ft)
Urban Single Lane	WB-15 (WB-50)	30–40m (100–130 ft)
Urban Double Lane	WB-15 (WB-50)	45–55m (150–180 ft)
Rural Single Lane	WB-20 (WB-67)	35–40m (115–130 ft)
Rural Double Lane	WB-20 (WB-67)	55–60m (180–200 ft)

* Assumes 90-degree angles between entries and no more than four legs.

6.3.2 Entry width

Entry width is the largest determinant of a roundabout's capacity. The capacity of an approach is not dependent merely on the number of entering lanes, but on the total width of the entry. In other words, the entry capacity increases steadily with incremental increases to the entry width. Therefore, the basic sizes of entries and circulatory roadways are generally described in terms of *width*, not number of lanes. Entries that are of sufficient width to accommodate multiple traffic streams (at least 6.0 m [20 ft]) are striped to designate separate lanes. However, the circulatory roadway is usually not striped, even when more than one lane of traffic is expected to circulate (for more details related to roadway markings, see Chapter 7).

As shown in Exhibit 6-1, entry width is measured from the point where the yield line intersects the left edge of the traveled-way to the right edge of the traveled-way, along a line perpendicular to the right curb line. The width of each entry is dictated by the needs of the entering traffic stream. It is based on design traffic volumes and can be determined in terms of the number of entry lanes by using Chapter 4 of this guide. The circulatory roadway must be at least as wide as the widest entry and must maintain a constant width throughout.

To maximize the roundabout's safety, entry widths should be kept to a minimum. The capacity requirements and performance objectives will dictate that each entry be a certain width, with a number of entry lanes. In addition, the turning requirements of the design vehicle may require that the entry be wider still. However, larger entry and circulatory widths increase crash frequency. Therefore, determining the entry width and circulatory roadway width involves a trade-off between capacity and safety. The design should provide the minimum width necessary for capacity and accommodation of the design vehicle in order to maintain the highest level of safety. Typical entry widths for single-lane entrances range from 4.3 to 4.9 m (14 to 16 ft); however, values higher or lower than this range may be required for site-specific design vehicle and speed requirements for critical vehicle paths.

When the capacity requirements can only be met by increasing the entry width, this can be done in two ways:

1. By adding a full lane upstream of the roundabout and maintaining parallel lanes through the entry geometry; or
2. By widening the approach gradually (flaring) through the entry geometry.

Exhibit 6-20 and Exhibit 6-21 illustrate these two widening options.

Entry width is the largest determinant of a roundabout's capacity.

Entry widths should be kept to a minimum to maximize safety while achieving capacity and performance objectives.

Exhibit 6-20. Approach widening by adding full lane.

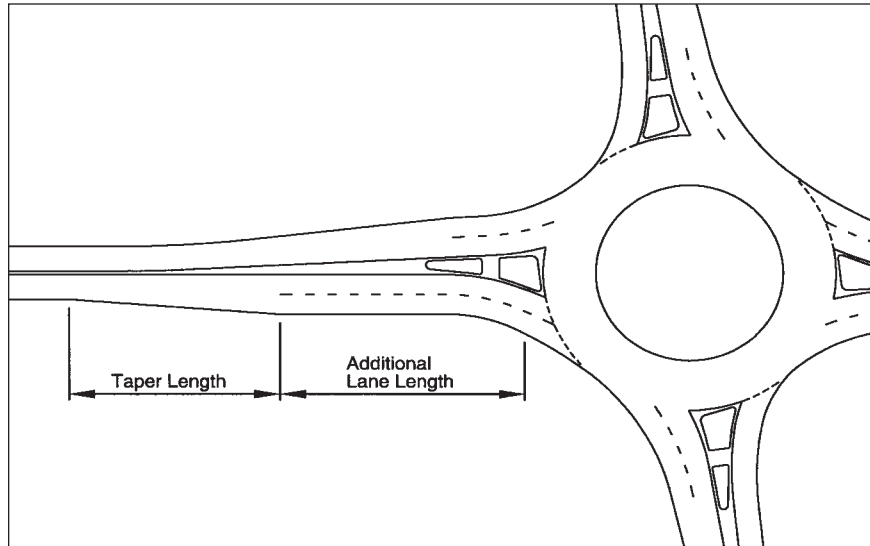
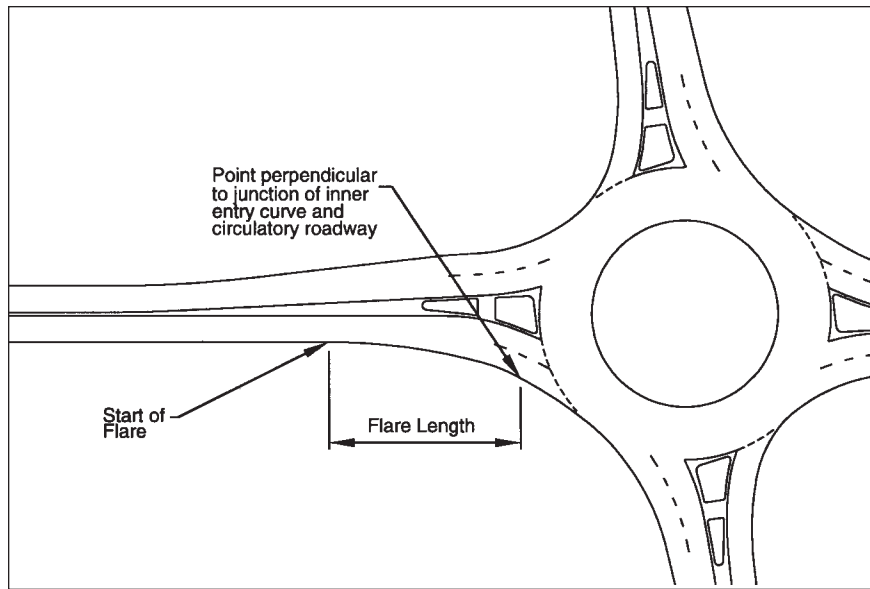

Exhibit 6-21. Approach widening by entry flaring.



Flare lengths should be at least 25 m in urban areas and 40 m in rural areas.

As discussed in Chapter 4, flaring is an effective means of increasing capacity without requiring as much right-of-way as a full lane addition. While increasing the length of flare increases capacity, it does not increase crash frequency. Consequently, the crash frequency for two approaches with the same entry width will be essentially the same, whether they have parallel entry lanes or flared entry designs. Entry widths should therefore be minimized and flare lengths maximized to achieve the desired capacity with minimal effect on crashes. Generally, flare lengths should be a minimum of 25 m (80 ft) in urban areas and 40 m (130 ft) in rural areas. However, if right-of-way is constrained, shorter lengths can be used with noticeable effects on capacity (see Chapter 4).

In some cases, a roundabout designed to accommodate design year traffic volumes, typically projected 20 years from the present, can result in substantially wider entries and circulatory roadway than needed in the earlier years of operation. Because safety will be significantly reduced by the increase in entry width, the designer may wish to consider a two-phase design solution. In this case, the first-phase design would provide the entry width requirements for near-term traffic volumes with the ability to easily expand the entries and circulatory roadway to accommodate future traffic volumes. The interim solution should be accomplished by first laying out the ultimate plan, then designing the first phase within the ultimate curb lines. The interim roundabout is often constructed with the ultimate inscribed circle diameter, but with a larger central island and splitter islands. At the time additional capacity is needed, the splitter and central islands can be reduced in size to provide additional widths at the entries, exits, and circulatory roadway.

Two-phase designs allow for small initial entry widths that can be easily expanded in the future when needed to accommodate greater traffic volumes.

6.3.3 Circulatory roadway width

The required width of the circulatory roadway is determined from the width of the entries and the turning requirements of the design vehicle. In general, it should always be at least as wide as the maximum entry width (up to 120 percent of the maximum entry width) and should remain constant throughout the roundabout (3).

6.3.3.1 Single-lane roundabouts

At single-lane roundabouts, the circulatory roadway should just accommodate the design vehicle. Appropriate vehicle-turning templates or a CAD-based computer program should be used to determine the swept path of the design vehicle through each of the turning movements. Usually the left-turn movement is the critical path for determining circulatory roadway width. In accordance with AASHTO policy, a minimum clearance of 0.6 m (2 ft) should be provided between the outside edge of the vehicle's tire track and the curb line. AASHTO Table III-19 (1994 edition) provides derived widths required for various radii for each standard design vehicle.

In some cases (particularly where the inscribed diameter is small or the design vehicle is large) the turning requirements of the design vehicle may dictate that the circulatory roadway be so wide that the amount of deflection necessary to slow passenger vehicles is compromised. In such cases, the circulatory roadway width can be reduced and a truck apron, placed behind a mountable curb on the central island, can be used to accommodate larger vehicles. However, truck aprons generally provide a lower level of operation than standard nonmountable islands. They are sometimes driven over by four-wheel drive automobiles, may surprise inattentive motorcyclists, and can cause load shifting on trucks. They should, therefore, be used only when there is no other means of providing adequate deflection while accommodating the design vehicle.

Truck aprons generally provide a lower level of operations, but may be needed to provide adequate deflection while still accommodating the design vehicle.

6.3.3.2 Double-lane roundabouts

At double-lane roundabouts, the circulatory roadway width is usually not governed by the design vehicle. The width required for one, two, or three vehicles, depending on the number of lanes at the widest entry, to travel simultaneously through the roundabout should be used to establish the circulatory roadway width. The

combination of vehicle types to be accommodated side-by-side is dependent upon the specific traffic conditions at each site. If the entering traffic is predominantly passenger cars and single-unit trucks (AASHTO P and SU vehicles), where semi-trailer traffic is infrequent, it may be appropriate to design the width for two passenger vehicles or a passenger car and a single-unit truck side-by-side. If semi-trailer traffic is relatively frequent (greater than 10 percent), it may be necessary to provide sufficient width for the simultaneous passage of a semi-trailer in combination with a P or SU vehicle.

Exhibit 6-22 provides minimum recommended circulatory roadway widths for two-lane roundabouts where semi-trailer traffic is relatively infrequent.

Exhibit 6-22. Minimum circulatory lane widths for two-lane roundabouts.

Inscribed Circle Diameter	Minimum Circulatory Lane Width*	Central Island Diameter
45 m (150 ft)	9.8 m (32 ft)	25.4 m (86 ft)
50 m (165 ft)	9.3 m (31 ft)	31.4 m (103 ft)
55 m (180 ft)	9.1 m (30 ft)	36.8 m (120 ft)
60 m (200 ft)	9.1 m (30 ft)	41.8 m (140 ft)
65 m (215 ft)	8.7 m (29 ft)	47.6 m (157 ft)
70 m (230 ft)	8.7 m (29 ft)	52.6 m (172 ft)

* Based on 1994 AASHTO Table III-20, Case III(A) (4). Assumes infrequent semi-trailer use (typically less than 5 percent of the total traffic). Refer to AASHTO for cases with higher truck percentages.

6.3.4 Central island

The central island of a roundabout is the raised, nontraversable area encompassed by the circulatory roadway; this area may also include a traversable apron. The island is typically landscaped for aesthetic reasons and to enhance driver recognition of the roundabout upon approach. Central islands should always be raised, not depressed, as depressed islands are difficult for approaching drivers to recognize.

In general, the central island should be circular in shape. A circular-shaped central island with a constant-radius circulatory roadway helps promote constant speeds around the central island. Oval or irregular shapes, on the other hand, are more difficult to drive and can promote higher speeds on the straight sections and reduced speeds on the arcs of the oval. This speed differential may make it harder for entering vehicles to judge the speed and acceptability of gaps in the circulatory traffic stream. It can also be deceptive to circulating drivers, leading to more loss-of-control crashes. Noncircular central islands have the above disadvantages to a rapidly increasing degree as they get larger because circulating speeds are higher. Oval shapes are generally not such a problem if they are relatively small and speeds are low. Raindrop-shaped islands may be used in areas where certain movements do not exist, such as interchanges (see Chapter 8), or at locations where certain turning movements cannot be safely accommodated, such as roundabouts with one approach on a relatively steep grade.

As described in Section 6.2.1, the size of the central island plays a key role in determining the amount of deflection imposed on the through vehicle's path. However, its diameter is entirely dependent upon the inscribed circle diameter and the required circulatory roadway width (see Sections 6.3.1 and 6.3.3, respectively). Therefore, once the inscribed diameter, circulatory roadway width, and initial entry geometry have been established, the fastest vehicle path must be drawn through the layout, as described in Section 6.2.1.3, to determine if the central island size is adequate. If the fastest path exceeds the design speed, the central island size may need to be increased, thus increasing the overall inscribed circle diameter. There may be other methods for increasing deflection without increasing the inscribed diameter, such as offsetting the approach alignment to the left, reducing the entry width, or reducing the entry radius. These treatments, however, may preclude the ability to accommodate the design vehicle.

In cases where right-of-way, topography, or other constraints preclude the ability to expand the inscribed circle diameter, a mountable apron may be added to the outer edge of the central island. This provides additional paved area to allow the over-tracking of large semi-trailer vehicles on the central island without compromising the deflection for smaller vehicles. Exhibit 6-23 shows a typical central island with a traversable apron.

Where aprons are used, they should be designed so that they are traversable by trucks, but discourage passenger vehicles from using them. They should generally be 1 to 4 m (3 to 13 ft) wide and have a cross slope of 3 to 4 percent away from the central island. To discourage use by passenger vehicles, the outer edge of the apron should be raised a minimum of 30 mm (1.2 in) above the circulatory roadway surface (6). The apron should be constructed of colored and/or textured paving



Leeds, MD

Exhibit 6-23. Example of central island with a traversable apron.

materials to differentiate it from the circulatory roadway. Care must be taken to ensure that delivery trucks will not experience load shifting as their rear trailer wheels track across the apron.

Issues regarding landscaping and other treatments within the central island are discussed in Chapter 7.

In general, roundabouts in rural environments typically need larger central islands than urban roundabouts in order to enhance their visibility and to enable the design of better approach geometry (2).

6.3.5 Entry curves

As shown in Exhibit 6-1, the entry curves are the set of one or more curves along the right curb (or edge of pavement) of the entry roadway leading into the circulatory roadway. It should not be confused with the *entry path curve*, defined by the radius of the fastest vehicular travel path through the entry geometry (R_1 , on Exhibit 6-12).

The entry radius is an important factor in determining the operation of a roundabout as it has significant impacts on both capacity and safety. The entry radius, in conjunction with the entry width, the circulatory roadway width, and the central island geometry, controls the amount of deflection imposed on a vehicle's entry path. Larger entry radii produce faster entry speeds and generally result in higher crash rates between entering and circulating vehicles. In contrast, the operational performance of roundabouts benefits from larger entry radii. As described in Chapter 4, British research has found that the capacity of an entry increases as its entry radius is increased (up to 20 m [65 ft], beyond which entry radius has little effect on capacity).

The entry curve is designed curvilinearly tangential to the outside edge of the circulatory roadway. Likewise, the projection of the inside (left) edge of the entry roadway should be curvilinearly tangential to the central island. Exhibit 6-24 shows a typical roundabout entrance geometry.

The primary objective in selecting a radius for the entry curve is to achieve the speed objectives, as described in Section 6.2.1. The entry radius should first produce an appropriate design speed on the fastest vehicular path. Second, it should desirably result in an entry path radius (R_1) equal to or less than the circulating path radius (R_2) (see Section 6.2.1.5).

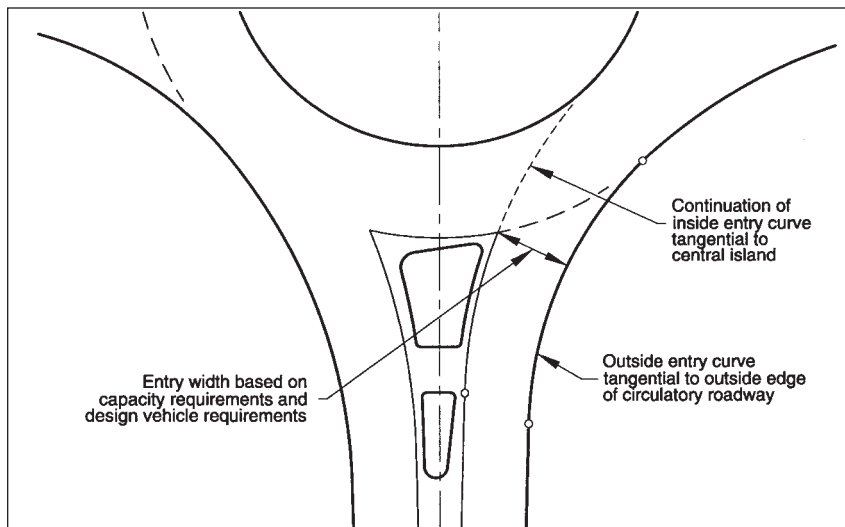

Exhibit 6-24. Single-lane roundabout entry design.

6.3.5.1 Entry curves at single-lane roundabouts

For single-lane roundabouts, it is relatively simple to achieve the entry speed objectives. With a single traffic stream entering and circulating, there is no conflict between traffic in adjacent lanes. Thus, the entry radius can be reduced or increased as necessary to produce the desired entry path radius. Provided sufficient clearance is given for the design vehicle, approaching vehicles will adjust their path accordingly and negotiate through the entry geometry into the circulatory roadway.

Entry radii at urban single-lane roundabouts typically range from 10 to 30 m (33 to 98 ft). Larger radii may be used, but it is important that the radii not be so large as to result in excessive entry speeds. At local street roundabouts, entry radii may be below 10 m (33 ft) if the design vehicle is small.

At rural and suburban locations, consideration should be given to the speed differential between the approaches and entries. If the difference is greater than 20 km/h (12 mph), it is desirable to introduce approach curves or some other speed reduction measures to reduce the speed of approaching traffic prior to the entry curvature. Further details on rural roundabout design are provided in Section 6.5.

6.3.5.2 Entry curves at double-lane roundabouts

At double-lane roundabouts, the design of the entry curvature is more complicated. Overly small entry radii can result in conflicts between adjacent traffic streams. This conflict usually results in poor lane utilization of one or more lanes and significantly reduces the capacity of the approach. It can also degrade the safety performance as sideswipe crashes may increase. Techniques and guidelines for avoiding conflicts between adjacent entry lanes at double-lane roundabouts are provided in Section 6.4.

6.3.6 Exit curves

Exit curves usually have larger radii than entry curves to minimize the likelihood of congestion at the exits. This, however, is balanced by the need to maintain low speeds at the pedestrian crossing on exit. The exit curve should produce an *exit path radius* (R_3 in Exhibit 6-12) no smaller than the circulating path radius (R_2). If the exit path radius is smaller than the circulating path radius, vehicles will be traveling too fast to negotiate the exit geometry and may crash into the splitter island or into oncoming traffic in the adjacent approach lane. Likewise, the exit path radius should not be significantly greater than the circulating path radius to ensure low speeds at the downstream pedestrian crossing.

The exit curve is designed to be curvilinearly tangential to the outside edge of the circulatory roadway. Likewise, the projection of the inside (left) edge of the exit roadway should be curvilinearly tangential to the central island. Exhibit 6-25 shows a typical exit layout for a single-lane roundabout.

Exhibit 6-25. Single-lane roundabout exit design.

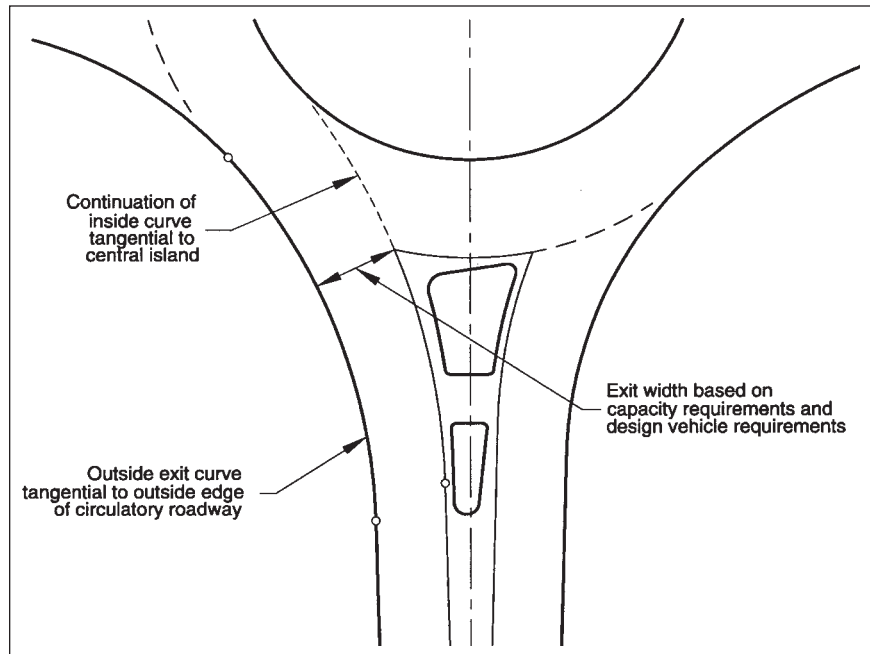

6.3.6.1 Exit curves at single-lane roundabouts

At single-lane roundabouts in urban environments, exits should be designed to enforce a curved exit path with a design speed below 40 km/h (25 mph) in order to maximize safety for pedestrians crossing the exiting traffic stream. Generally, exit radii should be no less than 15 m (50 ft). However, at locations with pedestrian activity and no large semi-trailer traffic, exit radii may be as low as 10 to 12 m (33 to 39 ft). This produces a very slow design speed to maximize safety and comfort for pedestrians. Such low exit radii should only be used in conjunction with similar or smaller entry radii on urban compact roundabouts with inscribed circle diameters below 35 m (115 ft).

In rural locations where there are few pedestrians, exit curvature may be designed with large radii, allowing vehicles to exit quickly and accelerate back to traveling speed. This, however, should not result in a straight path tangential to the central island because many locations that are rural today become urban in the future. Therefore, it is recommended that pedestrian activity be considered at all exits except where separate pedestrian facilities (paths, etc.) or other restrictions eliminate the likelihood of pedestrian activity in the foreseeable future.

6.3.6.2 Exit curves at double-lane roundabouts

As with the entries, the design of the exit curvature at double-lane roundabouts is more complicated than at single-lane roundabouts. Techniques and guidelines for avoiding conflicts between adjacent exit lanes at double-lane roundabouts are provided in Section 6.4.

6.3.7 Pedestrian crossing location and treatments

Pedestrian crossing locations at roundabouts are a balance among pedestrian convenience, pedestrian safety, and roundabout operations:

- *Pedestrian convenience:* Pedestrians want crossing locations as close to the intersection as possible to minimize out-of-direction travel. The further the crossing is from the roundabout, the more likely that pedestrians will choose a shorter route that may put them in greater danger.
- *Pedestrian safety:* Both crossing location and crossing distance are important. Crossing distance should be minimized to reduce exposure of pedestrian-vehicle conflicts. Pedestrian safety may also be compromised at a yield-line crosswalk because driver attention is directed to the left to look for gaps in the circulating traffic stream. Crosswalks should be located to take advantage of the splitter island; crosswalks located too far from the yield line require longer splitter islands. Crossings should also be located at distances away from the yield line measured in increments of approximate vehicle length to reduce the chance that vehicles will be queued across the crosswalk.

Pedestrian crossing locations must balance pedestrian convenience, pedestrian safety, and roundabout operations.

- *Roundabout operations:* Roundabout operations (primarily vehicular) can also be affected by crosswalk locations, particularly on the exit. A queuing analysis at the exit crosswalk may determine that a crosswalk location of more than one vehicle length away may be required to reduce to an acceptable level the risk of queuing into the circulatory roadway. Pedestrians may be able to distinguish exiting vehicles from circulating vehicles (both visually and audibly) at crosswalk locations further away from the roundabout, although this has not been confirmed by research.

With these issues in mind, pedestrian crossings should be designed as follows:

- The pedestrian refuge should be a minimum width of 1.8 m (6 ft) to adequately provide shelter for persons pushing a stroller or walking a bicycle (see Section 6.2.3).
- At single-lane roundabouts, the pedestrian crossing should be located one vehicle-length (7.5 m [25 ft]) away from the yield line. At double-lane roundabouts, the pedestrian crossing should be located one, two, or three car lengths (approximately 7.5 m, 15 m, or 22.5 m [25 ft, 50 ft, or 75 ft]) away from the yield line.
- The pedestrian refuge should be designed at street level, rather than elevated to the height of the splitter island. This eliminates the need for ramps within the refuge area, which can be cumbersome for wheelchairs.
- Ramps should be provided on each end of the crosswalk to connect the crosswalk to other crosswalks around the roundabout and to the sidewalk network.
- It is recommended that a detectable warning surface, as recommended in the Americans with Disabilities Act Accessibility Guidelines (ADAAG) §4.29 (Detectable Warnings), be applied to the surface of the refuge within the splitter island as shown in Exhibit 6-26. Note that the specific provision of the ADAAG requiring detectable warning surface at locations such as ramps and splitter islands (defined in the ADAAG as “hazardous vehicle areas”) has been suspended until July 26, 2001 (ADAAG §4.29.5). Where used, a detectable warning surface shall meet the following requirements (7):
 - The detectable warning surface shall consist of raised truncated domes with a nominal diameter of 23 mm (0.9 in), a nominal height of 5 mm (0.2 in), and a nominal center-to-center spacing of 60 mm (2.35 in).
 - The detectable warning surface shall contrast visually with adjoining surfaces, either light-on-dark or dark-on-light. The material used to provide contrast shall be an integral part of the walking surface.
 - The detectable warning surface shall begin at the curb line and extend into the pedestrian refuge area a distance of 600 mm (24 in). This creates a minimum 600-mm (24-in) clear space between detectable warning surfaces for a minimum splitter island width of 1.8 m (6 ft) at the pedestrian crossing. This is a deviation from the requirements of (suspended) ADAAG §4.29.5, which requires a 915-mm (36-in) surface width. However, this deviation is necessary to enable visually impaired pedestrians to distinguish the two interfaces with vehicular traffic.

Detectable warning surfaces should be applied within the pedestrian refuge.

In urban areas, speed tables (flat-top road humps) could be considered for wheelchair users, provided that good geometric design has reduced absolute vehicle

speeds to less than 20 km/h (12 mph) near the crossing. Pedestrian crossings across speed tables must have detectable warning material as described above to clearly delineate the edge of the street. Speed tables should generally be used only on streets with approach speeds of 55 km/h (35 mph) or less, as the introduction of a raised speed table in higher speed environments may increase the likelihood of single-vehicle crashes and is not consistent with the speed consistency philosophy presented in this document.

6.3.8 Splitter islands

Splitter islands (also called *separator islands* or *median islands*) should be provided on all roundabouts, except those with very small diameters at which the splitter island would obstruct the visibility of the central island. Their purpose is to provide shelter for pedestrians (including wheelchairs, bicycles, and baby strollers), assist in controlling speeds, guide traffic into the roundabout, physically separate entering and exiting traffic streams, and deter wrong-way movements. Additionally, splitter islands can be used as a place for mounting signs (see Chapter 7).

The splitter island envelope is formed by the entry and exit curves on a leg, as shown previously in Exhibits 6-24 and 6-25. The total length of the island should generally be at least 15 m (50 ft) to provide sufficient protection for pedestrians and to alert approaching drivers to the roundabout geometry. Additionally, the splitter island should extend beyond the end of the exit curve to prevent exiting traffic from accidentally crossing into the path of approaching traffic.

Exhibit 6-26 shows the minimum dimensions for a splitter island at a single-lane roundabout, including the location of the pedestrian crossing as discussed in Section 6.3.7.

Splitter islands perform multiple functions and should generally be provided.

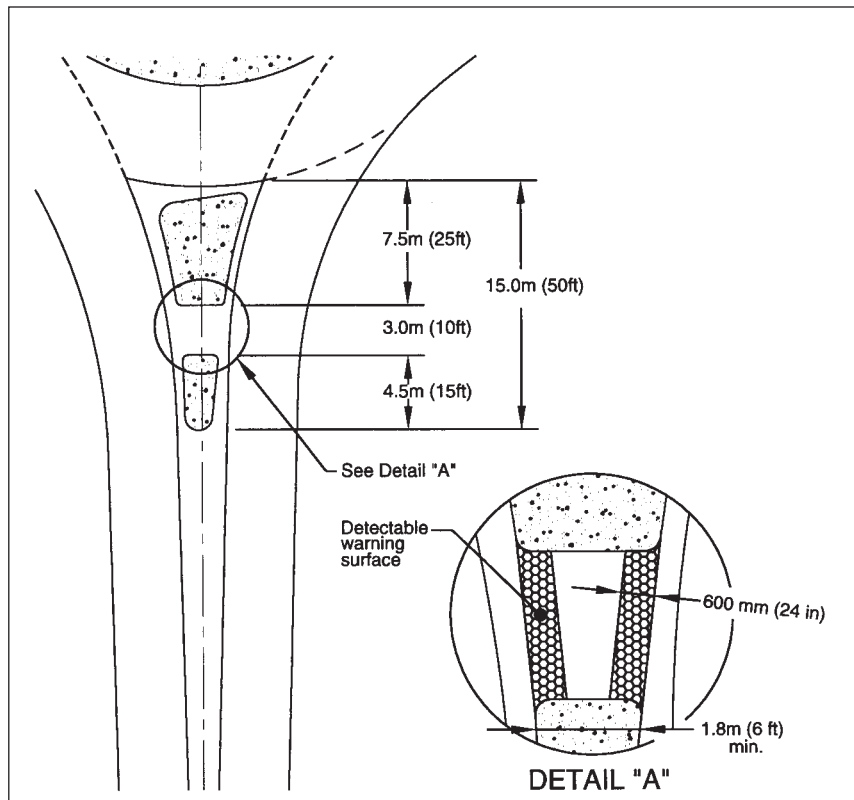

Exhibit 6-26. Minimum splitter island dimensions.

Larger splitter islands enhance safety, but require that the inscribed circle diameter be increased.

While Exhibit 6-26 provides minimum dimensions for splitter islands, there are benefits to providing larger islands. Increasing the splitter island width results in greater separation between the entering and exiting traffic streams of the same leg and increases the time for approaching drivers to distinguish between exiting and circulating vehicles. In this way, larger splitter islands can help reduce confusion for entering motorists. A recent study by the Queensland Department of Main Roads found that maximizing the width of splitter islands has a significant effect on minimizing entering/circulating vehicle crash rates (2). However, increasing the width of the splitter islands generally requires increasing the inscribed circle diameter. Thus, these safety benefits may be offset by higher construction cost and greater land impacts.

Standard AASHTO guidelines for island design should be followed for the splitter island. This includes using larger nose radii at approach corners to maximize island visibility and offsetting curb lines at the approach ends to create a funneling effect. The funneling treatment also aids in reducing speeds as vehicles approach the roundabout. Exhibit 6-27 shows minimum splitter island nose radii and offset dimensions from the entry and exit traveled ways.

Exhibit 6-27. Minimum splitter island nose radii and offsets.

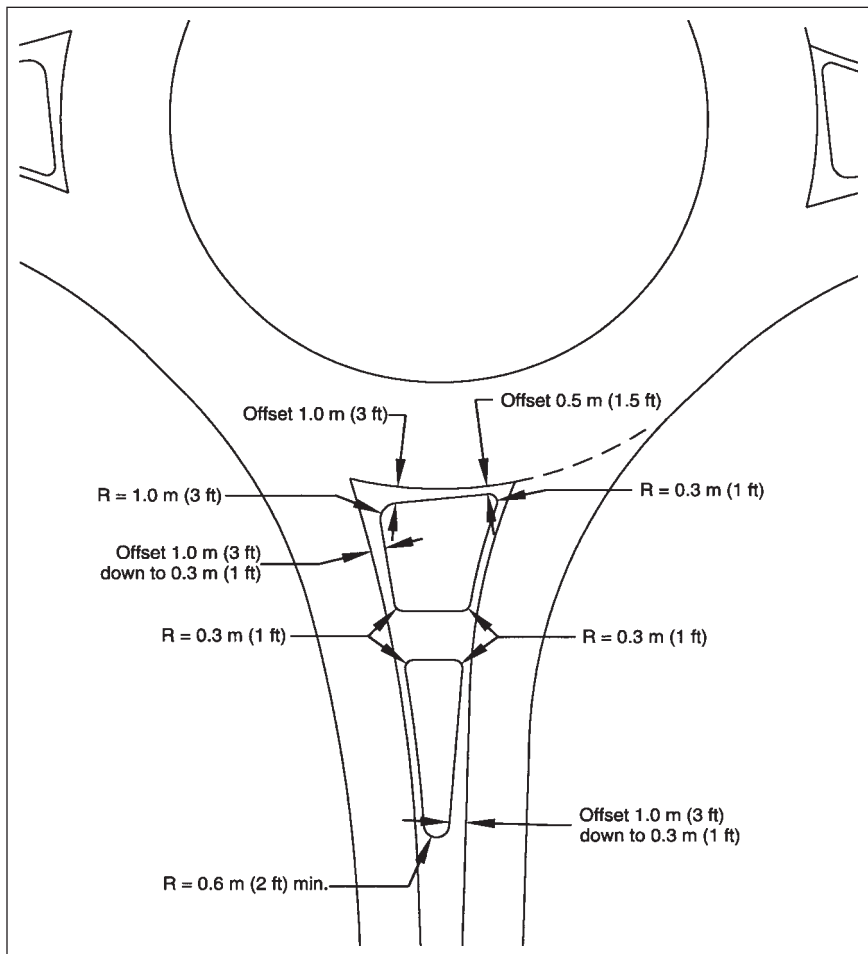

6.3.9 Stopping sight distance

Stopping sight distance is the distance along a roadway required for a driver to perceive and react to an object in the roadway and to brake to a complete stop before reaching that object. Stopping sight distance should be provided at every point within a roundabout and on each entering and exiting approach.

National Cooperative Highway Research Program (NCHRP) Report 400, *Determination of Stopping Sight Distances* (8), recommends the formula given in Equation 6-2 for determining stopping sight distance (presented in metric units, followed by a conversion of the equation to U.S. customary units).

$$d = (0.278)(t)(V) + 0.039 \frac{V^2}{a} \quad (6-2a, \text{ metric})$$

where: d = stopping sight distance, m;
t = perception-brake reaction time, assumed to be 2.5 s;
V = initial speed, km/h; and
a = driver deceleration, assumed to be 3.4 m/s².

$$d = (1.468)(t)(V) + 1.087 \frac{V^2}{a}$$

where: d = stopping sight distance, ft;
t = perception-brake reaction time, assumed to be 2.5 s;
V = initial speed, mph; and
a = driver deceleration, assumed to be 11.2 ft/s².

Exhibit 6-28 gives recommended stopping sight distances for design, as computed from the above equations.

Speed (km/h)	Computed Distance* (m)	Speed (mph)	Computed Distance* (ft)
10	8.1	10	46.4
20	18.5	15	77.0
30	31.2	20	112.4
40	46.2	25	152.7
50	63.4	30	197.8
60	83.0	35	247.8
70	104.9	40	302.7
80	129.0	45	362.
90	155.5	50	427.2
100	184.2 *	55	496.7

Assumes 2.5 s perception-braking time, 3.4 m/s² (11.2 ft/s²) driver deceleration

Exhibit 6-28. Design values for stopping sight distances.

Stopping sight distance should be measured using an assumed height of driver's eye of 1,080 mm (3.54 ft) and an assumed height of object of 600 mm (1.97 ft) in accordance with the recommendations to be adopted in the next AASHTO "Green Book" (8).

At least three critical types of locations should be checked for stopping sight distance.

At roundabouts, three critical types of locations should be checked at a minimum:

- Approach sight distance (Exhibit 6-29);
- Sight distance on circulatory roadway (Exhibit 6-30); and
- Sight distance to crosswalk on exit (Exhibit 6-31).

Forward sight distance at entry can also be checked; however, this will typically be satisfied by providing adequate stopping sight distance on the circulatory roadway itself.

Exhibit 6-29. Approach sight distance.

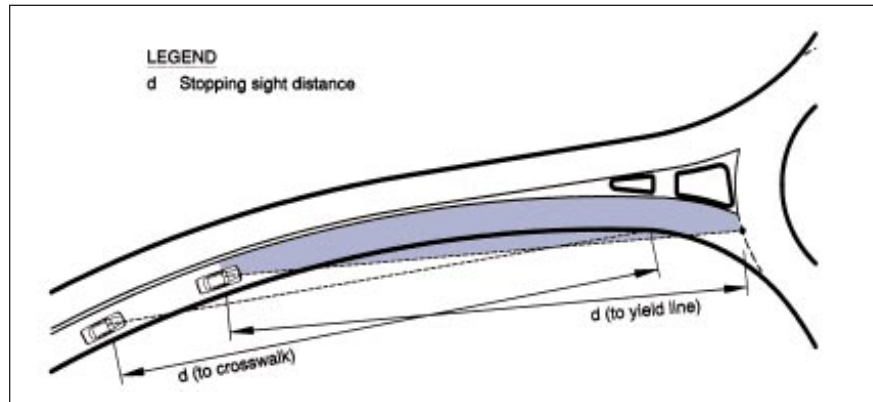
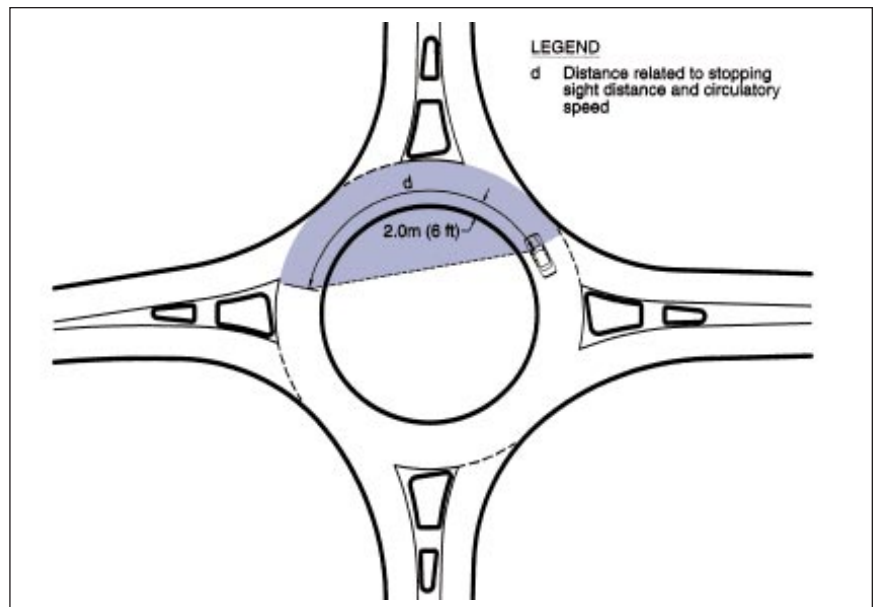

Exhibit 6-30. Sight distance on circulatory roadway.



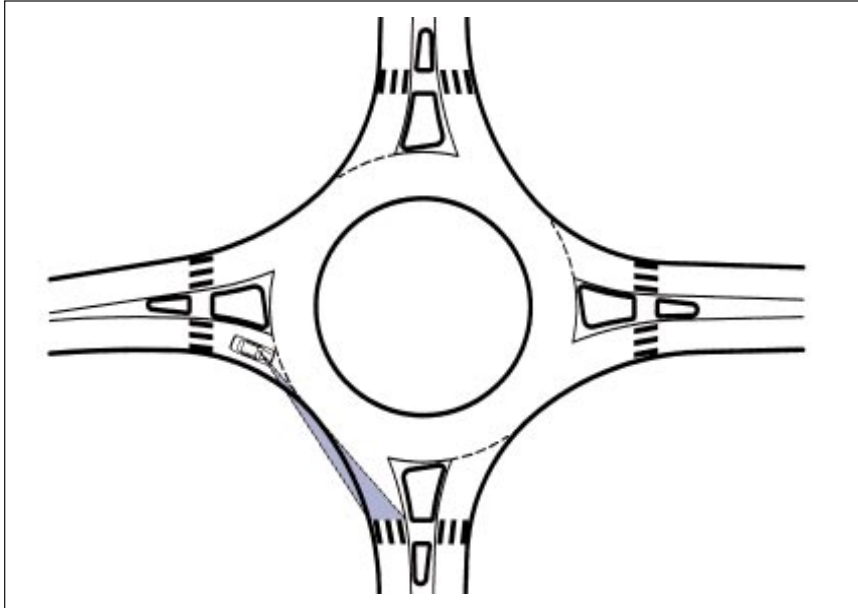

Exhibit 6-31. Sight distance to crosswalk on exit.

6.3.10 Intersection sight distance

Intersection sight distance is the distance required for a driver without the right of way to perceive and react to the presence of conflicting vehicles. Intersection sight distance is achieved through the establishment of adequate sight lines that allow a driver to see and safely react to potentially conflicting vehicles. At roundabouts, the only locations requiring evaluation of intersection sight distance are the entries.

Roundabout entries require adequate intersection sight distance.

Intersection sight distance is traditionally measured through the determination of a *sight triangle*. This triangle is bounded by a length of roadway defining a limit away from the intersection on each of the two conflicting approaches and by a line connecting those two limits. For roundabouts, these “legs” should be assumed to follow the curvature of the roadway, and thus distances should be measured not as straight lines but as distances along the vehicular path.

Intersection sight distance should be measured using an assumed height of driver’s eye of 1,080 mm (3.54 ft) and an assumed height of object of 1,080 mm (3.54 ft) in accordance with the recommendations to be adopted in the next AASHTO “Green Book” (4).

Exhibit 6-32 presents a diagram showing the method for determining intersection sight distance. As can be seen in the exhibit, the sight distance “triangle” has two conflicting approaches that must be checked independently. The following two subsections discuss the calculation of the length of each of the approaching sight limits.

Exhibit 6-32. Intersection sight distance

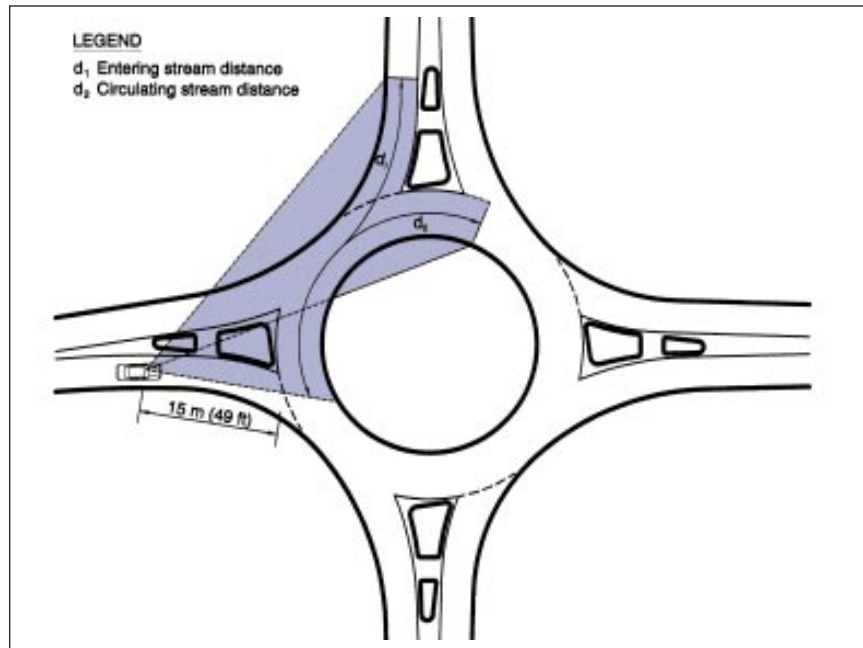

6.3.10.1 Length of approach leg of sight triangle

The length of the approach leg of the sight triangle should be limited to 15 m (49 ft). British research on sight distance determined that excessive intersection sight distance results in a higher frequency of crashes. This value, consistent with British and French practice, is intended to require vehicles to slow down prior to entering the roundabout, which allows them to focus on the pedestrian crossing prior to entry. If the approach leg of the sight triangle is greater than 15 m (49 ft), it may be advisable to add landscaping to restrict sight distance to the minimum requirements.

6.3.10.2 Length of conflicting leg of sight triangle

A vehicle approaching an entry to a roundabout faces conflicting vehicles within the circulatory roadway. The length of the conflicting leg is calculated using Equation 6-3:

$$b = 0.278(V_{major})(t_c) \quad (6-3a, \text{ metric})$$

where: b = length of conflicting leg of sight triangle, m
 V_{major} = design speed of conflicting movement, km/h, discussed below
 t_c = critical gap for entering the major road, s, equal to 6.5 s

$$b = 1.468(V_{major})(t_c) \quad (6-3b, \text{ U.S. customary})$$

where: b = length of conflicting leg of sight triangle, ft
 V_{major} = design speed of conflicting movement, mph, discussed below
 t_c = critical gap for entering the major road, s, equal to 6.5 s

Two conflicting traffic streams should be checked at each entry:

- *Entering stream*, comprised of vehicles from the immediate upstream entry. The speed for this movement can be approximated by taking the average of the entry path speed (path with radius R_1 from Exhibit 6-12) and the circulating path speed (path with radius R_2 from Exhibit 6-12).
- *Circulating stream*, comprised of vehicles that entered the roundabout prior to the immediate upstream entry. This speed can be approximated by taking the speed of left turning vehicles (path with radius R_4 from Exhibit 6-12).

The critical gap for entering the major road is based on the amount of time required for a vehicle to turn right while requiring the conflicting stream vehicle to slow no less than 70 percent of initial speed. This is based on research on critical gaps at stop-controlled intersections, adjusted for yield-controlled conditions (9). The critical gap value of 6.5 s given in Equation 6-3 is based on the critical gap required for passenger cars, which are assumed to be the most critical design vehicle for intersection sight distance. This assumption holds true for single-unit and combination truck speeds that are at least 10 km/h (6 mph) and 15 to 20 km/h (9 to 12 mph) slower than passenger cars, respectively.

Conflicting Approach Speed (km/h)	Computed Distance (m)	Conflicting Approach Speed (mph)	Computed Distance (ft)
20	36.1	10	95.4
25	45.2	15	143.0
30	54.2	20	190.1
35	63.2	25	238.6
40	72.3	30	286.3

Exhibit 6-33. Computed length of conflicting leg of intersection sight triangle.

In general, it is recommended to provide no more than the minimum required intersection sight distance on each approach. Excessive intersection sight distance can lead to higher vehicle speeds that reduce the safety of the intersection for all road users (vehicles, bicycles, pedestrians). Landscaping can be effective in restricting sight distance to the minimum requirements.

Providing more than the minimum required intersection sight distance can lead to higher speeds that reduce intersection safety.

Note that the stopping sight distance on the circulatory roadway (Exhibit 6-30) and the intersection sight distance to the circulating stream (Exhibit 6-32) imply restrictions on the height of the central island, including landscaping and other objects, within these zones. In the remaining central area of the central island, higher landscaping may serve to break the forward vista for through vehicles, thereby contributing to speed reduction. However, should errant vehicles encroach on the central island, Chapter 7 provides recommended maximum grades on the central island to minimize the probability of the vehicles rolling over, causing serious injury.

6.3.11 Vertical considerations

Elements of vertical alignment design for roundabouts include profiles, superelevation, approach grades, and drainage.

6.3.11.1 Profiles

The vertical design of a roundabout begins with the development of approach roadway and central island profiles. The development of each profile is an iterative process that involves tying the elevations of the approach roadway profiles into a smooth profile around the central island.

Generally, each approach profile should be designed to the point where the approach baseline intersects with the central island. A profile for the central island is then developed which passes through these four points (in the case of a four-legged roundabout). The approach roadway profiles are then readjusted as necessary to meet the central island profile. The shape of the central island profile is generally in the form of a sine curve. Examples of how the profile is developed can be found in Exhibits 6-34, 6-35, and 6-36, which consist of a sample plan, profiles on each approach, and a profile along the central island, respectively. Note that the four points where the approach roadway baseline intersects the central island baseline are identified on the central island profile.

Exhibit 6-34. Sample plan view.

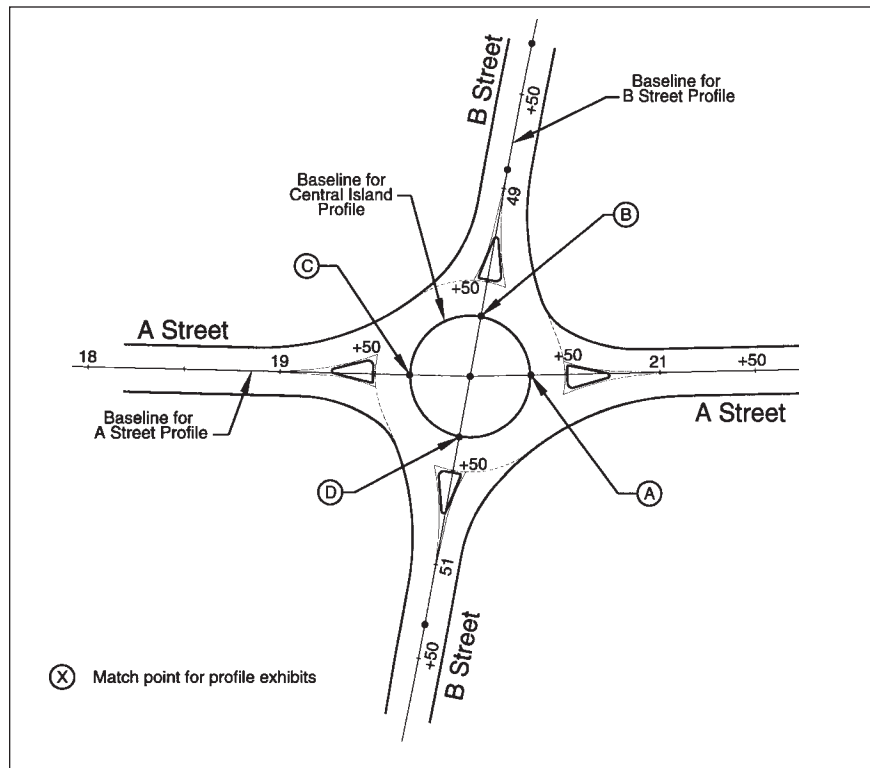

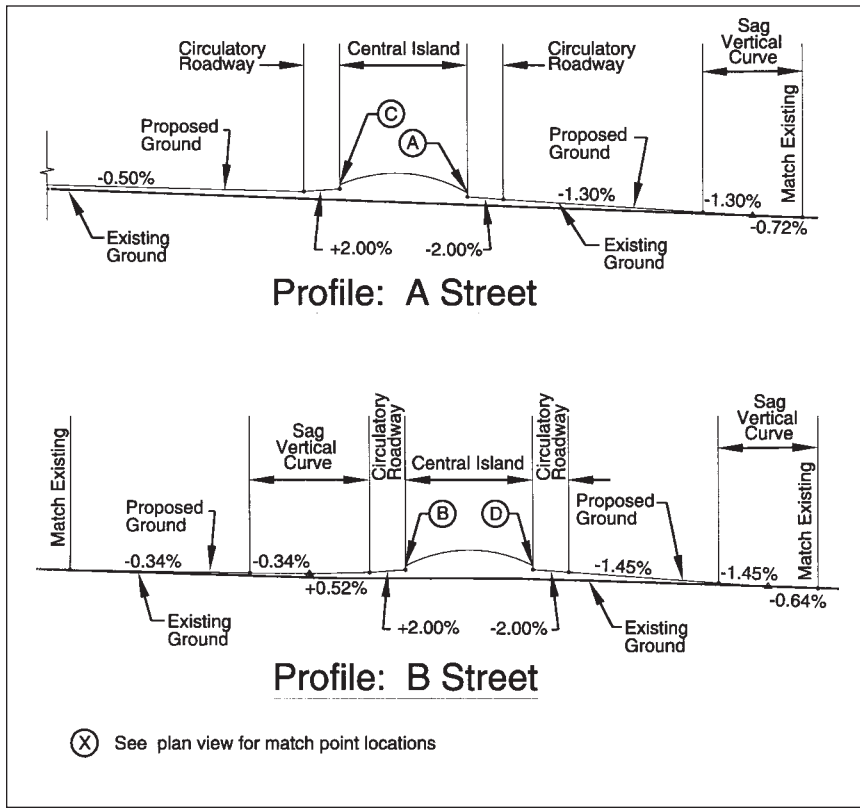

Exhibit 6-35. Sample approach profile.

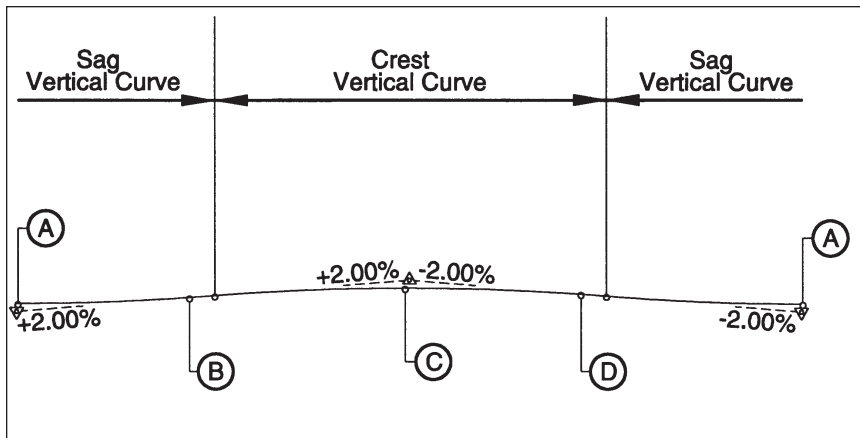

Exhibit 6-36. Sample central island profile.

Negative superelevation (- 2%) should generally be used for the circulatory roadway.

6.3.11.2 Superelevation

As a general practice, a cross slope of 2 percent away from the central island should be used for the circulatory roadway. This technique of sloping outward is recommended for four main reasons:

- It promotes safety by raising the elevation of the central island and improving its visibility;
- It promotes lower circulating speeds;
- It minimizes breaks in the cross slopes of the entrance and exit lanes; and
- It helps drain surface water to the outside of the roundabout (2, 6).

The outward cross slope design means vehicles making through and left-turn movements must negotiate the roundabout at negative superelevation. Excessive negative superelevation can result in an increase in single-vehicle crashes and loss-of-load incidents for trucks, particularly if speeds are high. However, in the intersection environment, drivers will generally expect to travel at slower speeds and will accept the higher side force caused by reasonable adverse superelevation (10).

Exhibit 6-37 provides a typical section across the circulatory roadway of a roundabout without a truck apron. Exhibit 6-38 provides a typical section for a roundabout with a truck apron. Where truck aprons are used, the slope of the apron should be 3 to 4 percent; greater slopes may increase the likelihood of loss-of-load incidents.

Exhibit 6-37. Typical circulatory roadway section.

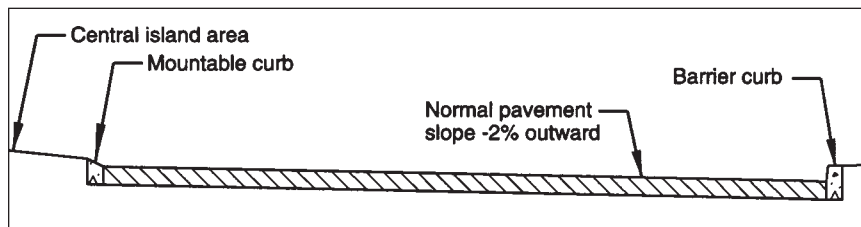
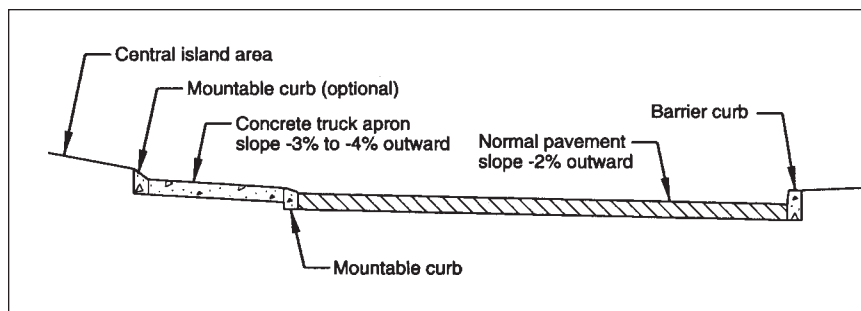

Exhibit 6-38. Typical section with a truck apron.



6.3.11.3 Locating roundabouts on grades

It is generally not desirable to locate roundabouts in locations where grades through the intersection are greater than four percent. The installation of roundabouts on roadways with grades lower than three percent is generally not problematic (6). At locations where a constant grade must be maintained through the intersection, the circulatory roadway may be constructed on a constant-slope plane. This means, for instance, that the cross slope may vary from +3 percent on the high side of the roundabout (sloped toward the central island) to -3 percent on the low side (sloped outward). Note that central island cross slopes will pass through level at a minimum of two locations for roundabouts constructed on a constant grade.

Care must be taken when designing roundabouts on steep grades. On approach roadways with grades steeper than -4 percent, it is more difficult for entering drivers to slow or stop on the approach. At roundabouts on crest vertical curves with steep approaches, a driver's sight lines will be compromised, and the roundabout may violate driver expectancy. However, under the same conditions, other types of at-grade intersections often will not provide better solutions. Therefore, the roundabout should not necessarily be eliminated from consideration at such a location. Rather, the intersection should be relocated or the vertical profile modified, if possible.

6.3.11.4 Drainage

With the circulatory roadway sloping away from the central island, inlets will generally be placed on the outer curbline of the roundabout. However, inlets may be required along the central island for a roundabout designed on a constant grade through an intersection. As with any intersection, care should be taken to ensure that low points and inlets are not placed in crosswalks. If the central island is large enough, the designer may consider placing inlets in the central island.

6.3.12 Bicycle provisions

With regard to bicycle treatments, the designer should strive to provide bicyclists the choice of proceeding through the roundabout as either a vehicle or a pedestrian. In general, bicyclists are better served by treating them as vehicles. However, the best design provides both options to allow cyclists of varying degrees of skill to choose their more comfortable method of navigating the roundabout.

To accommodate bicyclists traveling as vehicles, bike lanes should be terminated in advance of the roundabout to encourage cyclists to mix with vehicle traffic. Under this treatment, it is recommended that bike lanes end 30 m (100 ft) upstream of the yield line to allow for merging with vehicles (11). This method is most successful at smaller roundabouts with speeds below 30 km/h (20 mph), where bicycle speeds can more closely match vehicle speeds.

To accommodate bicyclists who prefer not to use the circulatory roadway, a widened sidewalk or a shared bicycle/pedestrian path may be provided physically separated from the circulatory roadway (not as a bike lane within the circulatory

Avoid locating roundabouts in areas where grades through the intersection are greater than 4%.

Terminate bicycle lanes prior to a roundabout.

Ramps leading to a shared pathway can be used to accommodate bicyclists traveling as pedestrians.

roadway). Ramps or other suitable connections can then be provided between this sidewalk or path and the bike lanes, shoulders, or road surface on the approaching and departing roadways. The designer should exercise care in locating and designing the bicycle ramps so that they are not misconstrued by pedestrians as an unmarked pedestrian crossing. Nor should the exits from the roadway onto a shared path allow cyclists to enter the shared path at excessive speeds. Exhibit 6-39 illustrates a possible design of this treatment. The reader is encouraged to refer to the *AASHTO Guide for Development of Bicycle Facilities* (12) for a more detailed discussion of the design requirements for bicycle and shared-use path design.

Exhibit 6-39. Possible provisions for bicycles.

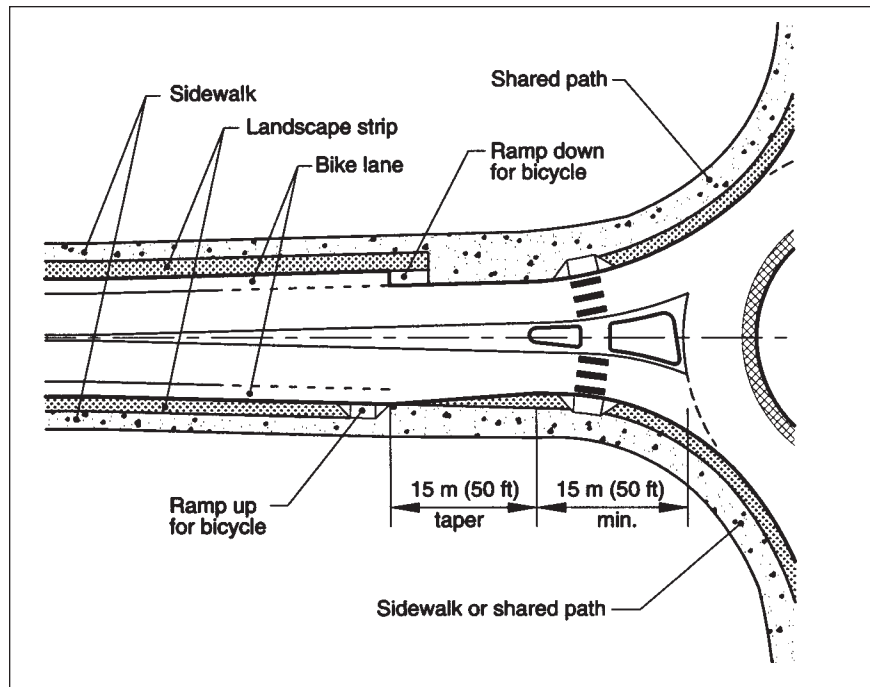

6.3.13 Sidewalk treatments

Set back sidewalks 1.5 m (5 ft) from the circulatory roadway where possible.

Where possible, sidewalks should be set back from the edge of the circulatory roadway in order to discourage pedestrians from crossing to the central island, particularly when an apron is present or a monument on the central island. Equally important, the design should help pedestrians with visual impairments to recognize that they should not attempt to cross streets from corner to corner but at designated crossing points. To achieve these goals, the sidewalk should be designed so that pedestrians will be able to clearly find the intended path to the crosswalks. A recommended set back distance of 1.5 m (5 ft) (minimum 0.6 m [2 ft]) should be used, and the area between the sidewalk and curb can be planted with low shrubs or grass (see Chapter 7). Exhibit 6-40 shows this technique.

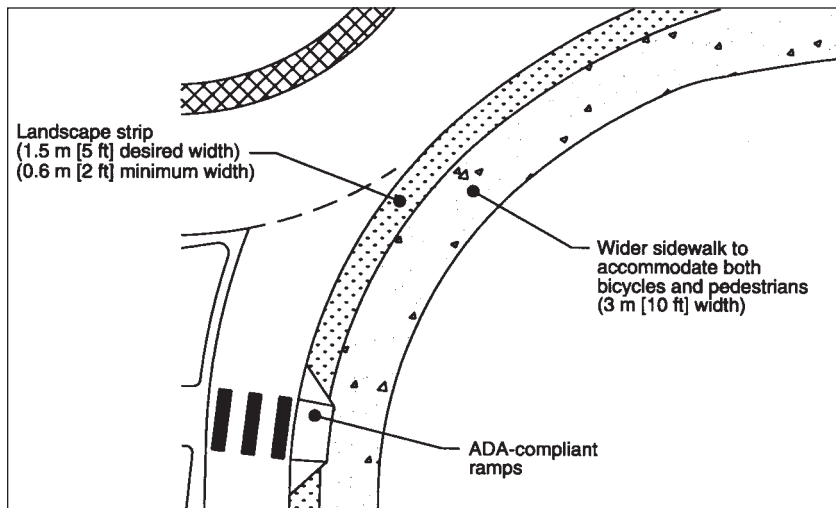

Exhibit 6-40. Sidewalk treatments.

6.3.14 Parking considerations and bus stop locations

Parking or stopping in the circulatory roadway is not conducive to proper roundabout operations and should be prohibited. Parking on entries and exits should also be set back as far as possible so as not to hinder roundabout operations or to impair the visibility of pedestrians. AASHTO recommends that parking should end at least 6.1 m (20 ft) from the crosswalk of an intersection (4). Curb extensions or “bulb-outs” can be used to clearly mark the limit of permitted parking and reduce the width of the entries and exits.

For safety and operational reasons, bus stops should be located as far away from entries and exits as possible, and never in the circulatory roadway.

- *Near-side stops:* If a bus stop is to be provided on the near side of a roundabout, it should be located far enough away from the splitter island so that a vehicle overtaking a stationary bus is in no danger of being forced into the splitter island, especially if the bus starts to pull away from the stop. If an approach has only one lane and capacity is not an issue on that entry, the bus stop could be located at the pedestrian crossing in the lane of traffic. This is not recommended for entries with more than one lane, because vehicles in the lane next to the bus may not see pedestrians.
- *Far-side stops:* Bus stops on the far side of a roundabout should be constructed with pull-outs to minimize queuing into the roundabout. These stops should be located beyond the pedestrian crossing to improve visibility of pedestrians to other exiting vehicles.

Right-turn bypass lanes can be used in locations with minimal pedestrian and bicycle activity to improve capacity when heavy right-turning traffic exists.

6.3.15 Right-turn bypass lanes

In general, right-turn bypass lanes (or *right-turn slip lanes*) should be avoided, especially in urban areas with bicycle and pedestrian activity. The entries and exits of bypass lanes can increase conflicts with bicyclists. The generally higher speeds of bypass lanes and the lower expectation of drivers to stop increases the risk of collisions with pedestrians. However, in locations with minimal pedestrian and bicycle activity, right-turn bypass lanes can be used to improve capacity where there is heavy right turning traffic.

The provision of a right-turn bypass lane allows right-turning traffic to bypass the roundabout, providing additional capacity for the through and left-turn movements at the approach. They are most beneficial when the demand of an approach exceeds its capacity and a significant proportion of the traffic is turning right. However, it is important to consider the reversal of traffic patterns during the opposite peak time period. In some cases, the use of a right-turn bypass lane can avoid the need to build an additional entry lane and thus a larger roundabout. To determine if a right-turn bypass lane should be used, the capacity and delay calculations in Chapter 4 should be performed. Right-turn bypass lanes can also be used in locations where the geometry for right turns is too tight to allow trucks to turn within the roundabout.

Exhibit 6-41 shows an example of a right-turn bypass lane.

Exhibit 6-41. Example of right-turn bypass lane.



There are two design options for right-turn bypass lanes. The first option, shown in Exhibit 6-42, is to carry the bypass lane parallel to the adjacent exit roadway, and then merge it into the main exit lane. Under this option, the bypass lane should be carried alongside the main roadway for a sufficient distance to allow vehicles in the bypass lane and vehicles exiting the roundabout to accelerate to comparable speeds. The bypass lane is then merged at a taper rate according to AASHTO guidelines for the appropriate design speed. The second design option for a right-turn bypass lane, shown in Exhibit 6-43, is to provide a yield-controlled entrance onto the adjacent exit roadway. The first option provides better operational performance than the second does. However, the second option generally requires less construction and right-of-way than the first.

Right-turn bypass lanes can merge back into the main exit roadway or provide a yield-controlled entrance onto the main exit roadway.

The option of providing yield control on a bypass lane is generally better for both bicyclists and pedestrians and is recommended as the preferred option in urban areas where pedestrians and bicyclists are prevalent. Acceleration lanes can be problematic for bicyclists because they end up being to the left of accelerating motor vehicles. In addition, yield control at the end of a bypass lane tends to slow motorists down, whereas an acceleration lane at the end of a bypass lane tends to promote higher speeds.

The radius of the right-turn bypass lane should not be significantly larger than the radius of the fastest entry path provided at the roundabout. This will ensure vehicle speeds on the bypass lane are similar to speeds through the roundabout, resulting in safe merging of the two roadways. Providing a small radius also provides greater safety for pedestrians who must cross the right-turn slip lane.

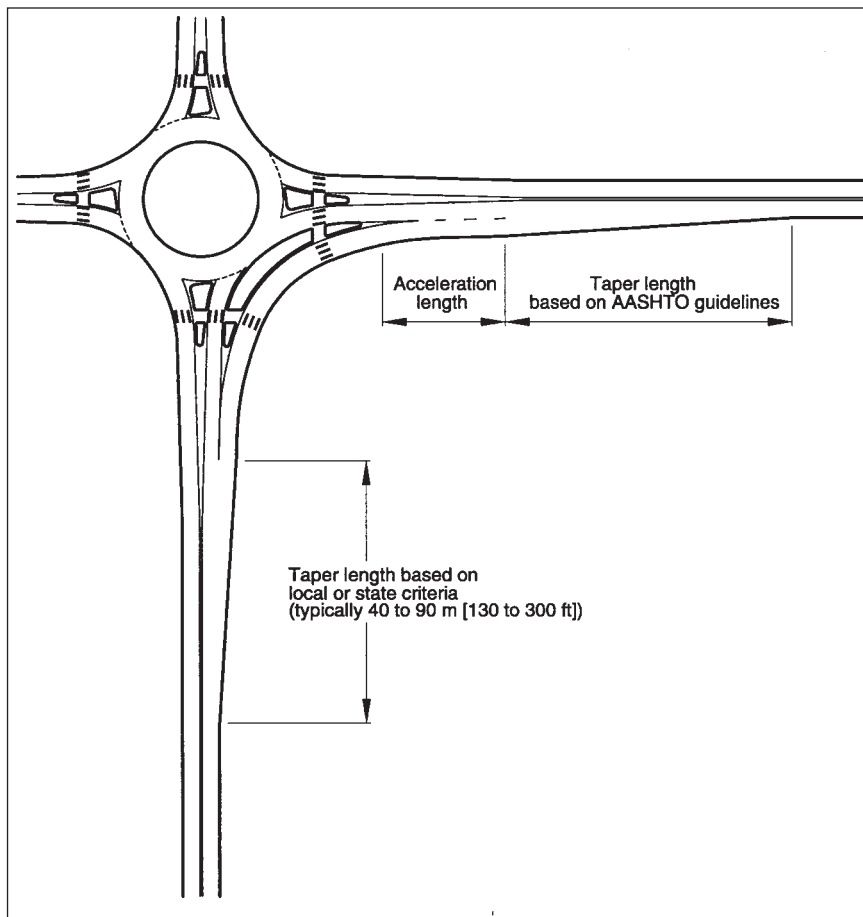
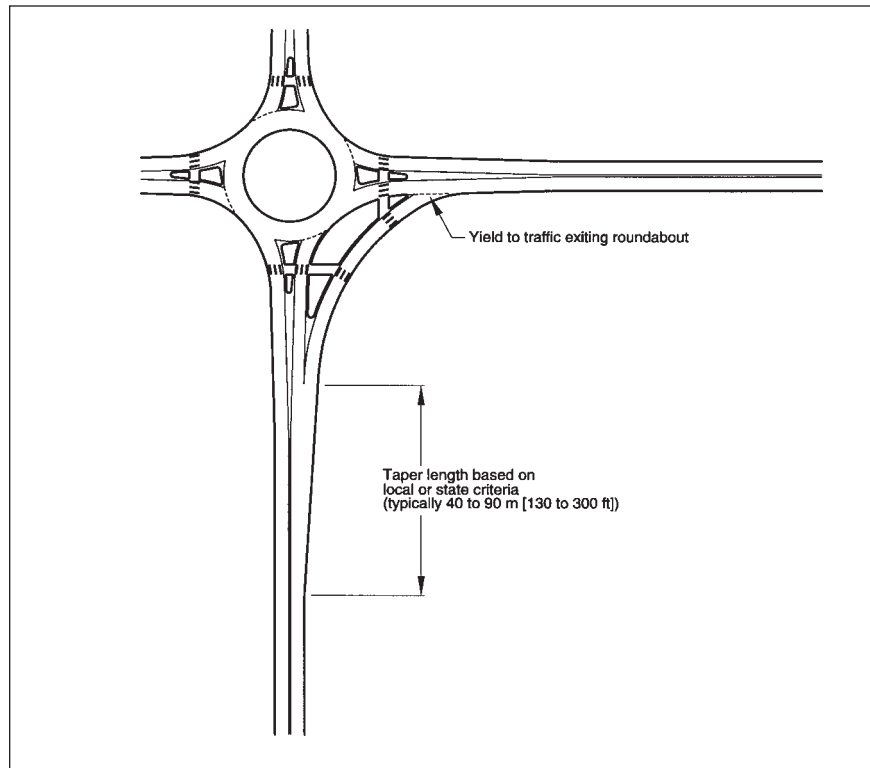

Exhibit 6-42. Configuration of right-turn bypass lane with acceleration lane.

Exhibit 6-43. Configuration of right-turn bypass with yield at exit leg.



6.4 Double-Lane Roundabouts

While the fundamental principles described above apply to double-lane roundabouts as well as single-lane roundabouts, designing the geometry of double-lane roundabouts is more complicated. Because multiple traffic streams may enter, circulate through, and exit the roundabout side-by-side, consideration must be given to how these adjacent traffic streams interact with each other. Vehicles in adjacent entry lanes must be able to negotiate the roundabout geometry without competing for the same space. Otherwise, operational and/or safety deficiencies can occur.

6.4.1 The natural vehicle path

As discussed in Section 6.2.1, the fastest path through the roundabout is drawn to ensure the geometry imposes sufficient curvature to achieve a safe design speed. This path is drawn assuming the roundabout is vacant of all other traffic and the vehicle cuts across adjacent travel lanes, ignoring all lane markings. In addition to evaluating the fastest path, at double-lane roundabouts the designer must also evaluate the *natural* vehicle paths. This is the path an approaching vehicle will naturally take, assuming there is traffic in all approach lanes, through the roundabout geometry.

As two traffic streams approach the roundabout in adjacent lanes, they will be forced to stay in their lanes up to the yield line. At the yield point, vehicles will continue along their natural trajectory into the circulatory roadway, then curve around the central island, and curve again into the opposite exit roadway. The speed and orientation of the vehicle at the yield line determines its natural path. If the natural path of one lane interferes or overlaps with the natural path of the adjacent lane, the roundabout will not operate as safely or efficiently as possible.

The key principle in drawing the natural path is to remember that drivers cannot change the direction of their vehicle instantaneously. Neither can they change their speed instantaneously. This means that the natural path does not have sudden changes in curvature; it has transitions between tangents and curves and between consecutive reversing curves. Secondly, it means that consecutive curves should be of similar radius. If a second curve has a significantly smaller radius than the first curve, the driver will be traveling too fast to negotiate the turn and may lose control of the vehicle. If the radius of one curve is drawn significantly smaller than the radius of the previous curve, the path should be adjusted.

To identify the natural path of a given design, it may be advisable to sketch the natural paths over the geometric layout, rather than use a computer drafting program or manual drafting equipment. In sketching the path, the designer will naturally draw transitions between consecutive curves and tangents, similar to the way a driver would negotiate an automobile. Freehand sketching also enables the designer to feel how changes in one curve affect the radius and orientation of the next curve. In general, the sketch technique allows the designer to quickly obtain a smooth, natural path through the geometry that may be more difficult to obtain using a computer.

Exhibit 6-44 illustrates a sketched natural path of a vehicle through a typical double-lane roundabout.

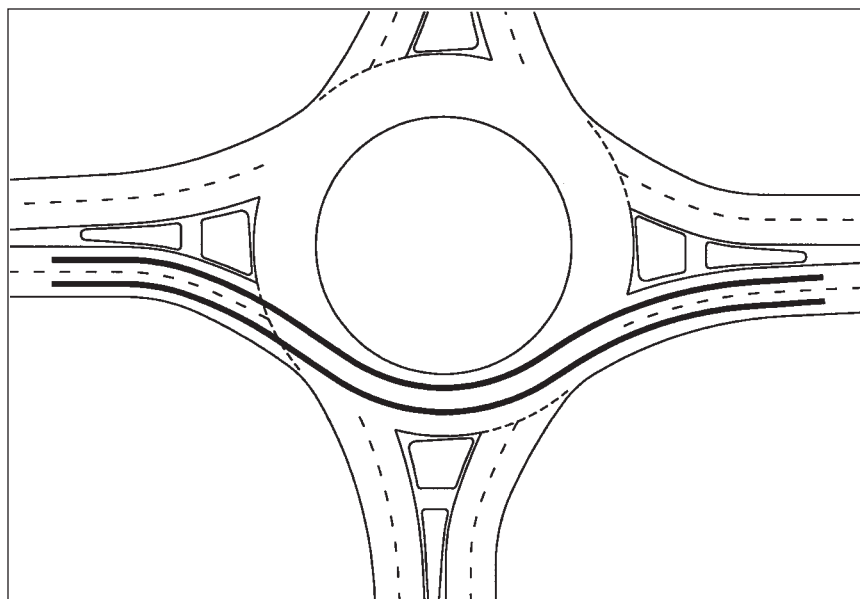
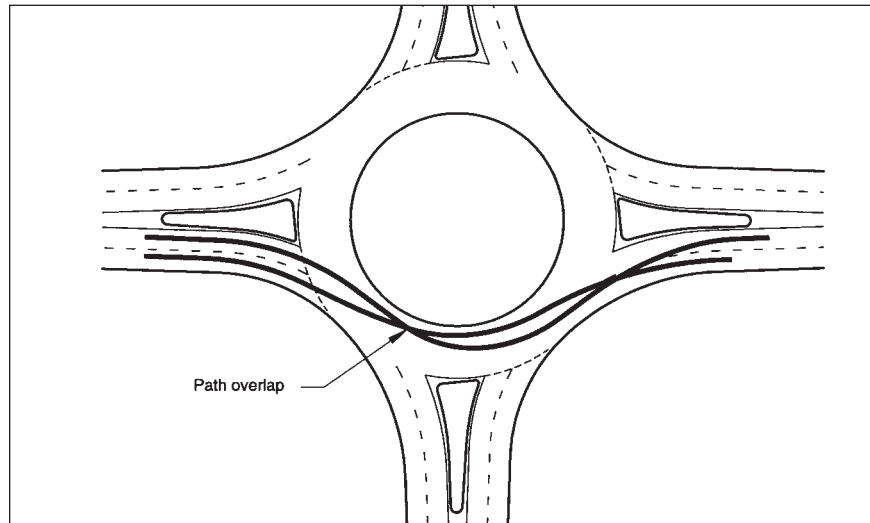

Exhibit 6-44. Sketched natural paths through a double-lane roundabout.

6.4.2 Vehicle path overlap

Vehicle path overlap occurs when the natural path through the roundabout of one traffic stream overlaps the path of another. This can happen to varying degrees. It can reduce capacity, as vehicles will avoid using one or more of the entry lanes. It can also create safety problems, as the potential for sideswipe and single-vehicle crashes is increased. The most common type of path overlap is where vehicles in the left lane on entry are cut off by vehicles in the right lane, as shown in Exhibit 6-45.

Exhibit 6-45. Path overlap at a double-lane roundabout.



6.4.3 Design method to avoid path overlap

Achieving a reasonably low design speed at a double-lane roundabout while avoiding vehicle path overlap can be difficult because of conflicting interaction between the various geometric parameters. Providing small entry radii can produce low entry speeds, but often leads to path overlap on the entry, as vehicles will cut across lanes to avoid running into the central island. Likewise, providing small exit radii can aid in keeping circulating speeds low, but may result in path overlap at the exits.

6.4.3.1 Entry curves

At double-lane entries, the designer needs to balance the need to control entry speed with the need to minimize path overlap. This can be done a variety of ways that will vary significantly depending on site-specific conditions, and it is thus inappropriate to specify a single method for designing double-lane roundabouts. Regardless of the specific design method employed, the designer should maintain the overall design principles of speed control and speed consistency presented in Section 6.2.

One method to avoid path overlap on entry is to start with an inner entry curve that is curvilinearly tangential to the central island and then draw parallel alignments to determine the position of the outside edge of each entry lane. These curves can range from 30 to 60 m (100 to 200 ft) in urban environments and 40 to 80 m (130 to 260 ft) in rural environments. These curves should extend approximately 30 m (100

ft) to provide clear indication of the curvature to the driver. The designer should check the critical vehicle paths to ensure that speeds are sufficiently low and consistent between vehicle streams. The designer should also ensure that the portion of the splitter island in front of the crosswalk meets AASHTO recommendations for minimum size. Exhibit 6-46 demonstrates this method of design.

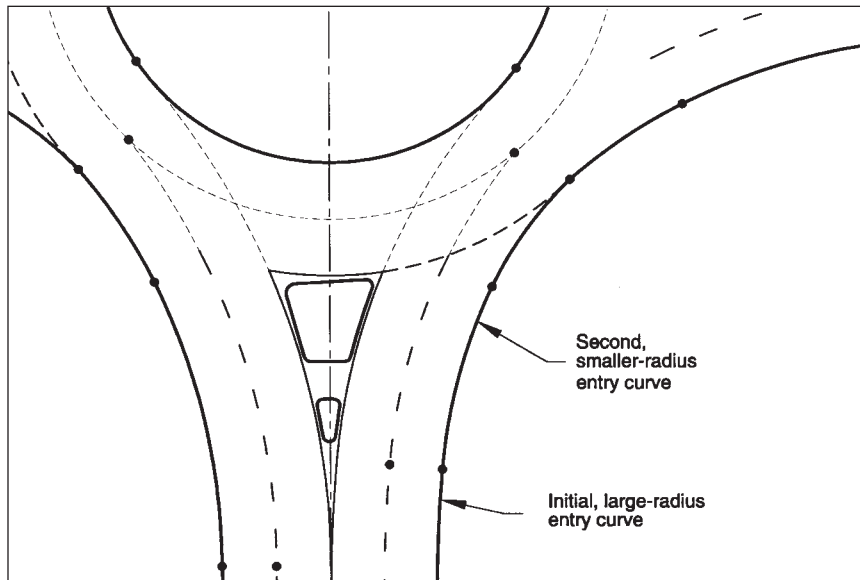

Exhibit 6-46. One method of entry design to avoid path overlap at double-lane roundabouts.

Another method to reduce entry speeds and avoid path overlap is to use a small-radius (generally 15 to 30 m [50 to 100 ft]) curve approximately 10 to 15 m (30 to 50 ft) upstream of the yield line. A second, larger-radius curve (or even a tangent) is then fitted between the first curve and the edge of the circulatory roadway. In this way, vehicles will still be slowed by the small-radius approach curve, and they will be directed along a path that is tangential to the central island at the time they reach the yield line. Exhibit 6-47 demonstrates this alternate method of design.

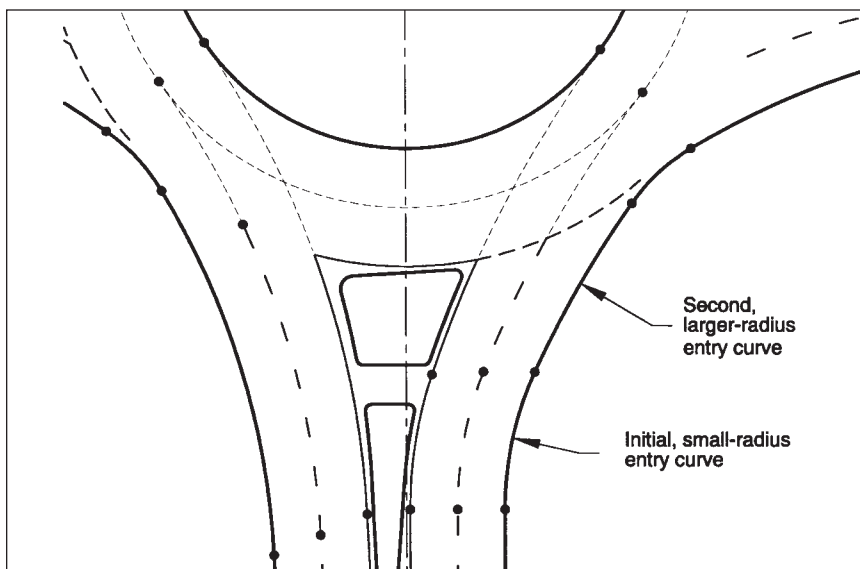

Exhibit 6-47. Alternate method of entry design to avoid path overlap at double-lane roundabouts.

As in the case of single-lane roundabouts, it is a primary objective to ensure that the entry path radius along the fastest path is not substantially larger than the circulating path radius. Referring to Exhibit 6-12, it is desirable for R_1 to be less than or approximately equal to R_2 . At double-lane roundabouts, however, R_1 should not be excessively small. If R_1 is too small, vehicle path overlap may result, reducing the operational efficiency and increasing potential for crashes. Values for R_1 in the range of 40 to 70 m (130 to 230 ft) are generally preferable. This results in a design speed of 35 to 45 km/h (22 to 28 mph).

The entry path radius, R_1 , is controlled by the offset between the right curb line on the entry roadway and the curb line of the central island (on the driver's left). If the initial layout produces an entry path radius above the preferred design speed, one way to reduce it is to gradually shift the approach to the left to increase the offset; however, this may increase adjacent exit speeds. Another method to reduce the entry path radius is to move the initial, small-radius entry curve closer to the circulatory roadway. This will decrease the length of the second, larger-radius curve and increase the deflection for entering traffic. However, care must be taken to ensure this adjustment does not produce overlapping natural paths.

6.4.3.2 Exit curves

To avoid path overlap on the exit, it is important that the exit radius at a double-lane roundabout not be too small. At single-lane roundabouts, it is acceptable to use a minimal exit radius in order to control exit speeds and maximize pedestrian safety. However, the same is not necessarily true at double-lane roundabouts. If the exit radius is too small, traffic on the inside of the circulatory roadway will tend to exit into the outside exit lane on a more comfortable turning radius.

At double-lane roundabouts in urban environments, the principle for maximizing pedestrian safety is to reduce vehicle speeds prior to the yield and maintain similar (or slightly lower) speeds within the circulatory roadway. At the exit points, traffic will still be traveling slowly, as there is insufficient distance to accelerate significantly. If the entry and circulating path radii (R_1 and R_2 , as shown on Exhibit 6-12) are each 50 m (165 ft), exit speeds will generally be below 40 km/h (25 mph) regardless of the exit radius.

To achieve exit speeds slower than 40 km/h (25 mph), as is often desirable in environments with significant pedestrian activity, it may be necessary to tighten the exit radius. This may improve safety for pedestrians at the possible expense of increased vehicle-vehicle collisions.

6.5 Rural Roundabouts

Roundabouts located on rural roads often have special design considerations because approach speeds are higher than urban or local streets and drivers generally do not expect to encounter speed interruptions. The primary safety concern in rural locations is to make drivers aware of the roundabout with ample distance to comfortably decelerate to the appropriate speed. This section provides design guidelines for providing additional speed-reduction measures on rural roundabout approaches.

6.5.1 Visibility

Perhaps the most important element affecting safety at rural intersections is the visibility of the intersection itself. Roundabouts are no different from stop-controlled or signalized intersections in this respect except for the presence of curbing along roadways that are typically not curbed. Therefore, although the number and severity of multiple-vehicle collisions at roundabouts may decrease (as discussed previously), the number of single-vehicle crashes may increase. This potential can be minimized with attention to proper visibility of the roundabout and its approaches.

Where possible, the geometric alignment of approach roadways should be constructed to maximize the visibility of the central island and the general shape of the roundabout. Where adequate visibility cannot be provided solely through geometric alignment, additional treatments (signing, pavement markings, advanced warning beacons, etc.) should be considered (see Chapter 7). Note that many of these treatments are similar to those that would be applied to rural stop-controlled or signalized intersections.

6.5.2 Curbing

On an open rural highway, changes in the roadway's cross-section can be an effective means to help approaching drivers recognize the need to reduce their speed. Rural highways typically have no outside curbs with wide paved or gravel shoulders. Narrow shoulder widths and curbs on the outside edges of pavement, on the other hand, generally give drivers a sense they are entering a more urbanized setting, causing them to naturally slow down. Thus, consideration should be given to reducing shoulder widths and introducing curbs when installing a roundabout on an open rural highway.

Curbs help to improve delineation and to prevent "corner cutting," which helps to ensure low speeds. In this way, curbs help to confine vehicles to the intended design path. The designer should carefully consider all likely design vehicles, including farm equipment, when setting curb locations. Little research has been performed to date regarding the length of curbing required in advance of a rural roundabout. In general, it may be desirable to extend the curbing from the approach for at least the length of the required deceleration distance to the roundabout.

6.5.3 Splitter islands

Another effective cross-section treatment to reduce approach speeds is to use longer splitter islands on the approaches (10). Splitter islands should generally be extended upstream of the yield bar to the point at which entering drivers are expected to begin decelerating comfortably. A minimum length of 60 m (200 ft) is recommended (10). Exhibit 6-48 provides a diagram of such a splitter island design. The length of the splitter island may differ depending upon the approach speed. The AASHTO recommendations for required braking distance with an alert driver should be applied to determine the ideal splitter island length for rural roundabout approaches.

A further speed-reduction technique is the use of landscaping on the extended splitter island and roadside to create a "tunnel" effect. If such a technique is used, the stopping and intersection sight distance requirements (sections 6.3.9 and 6.3.10) will dictate the maximum extent of such landscaping.

Roundabout visibility is a key design element at rural locations.

Curbs should be provided at all rural roundabouts.

Extended splitter islands are recommended at rural locations.

Exhibit 6-48. Extended splitter island treatment.

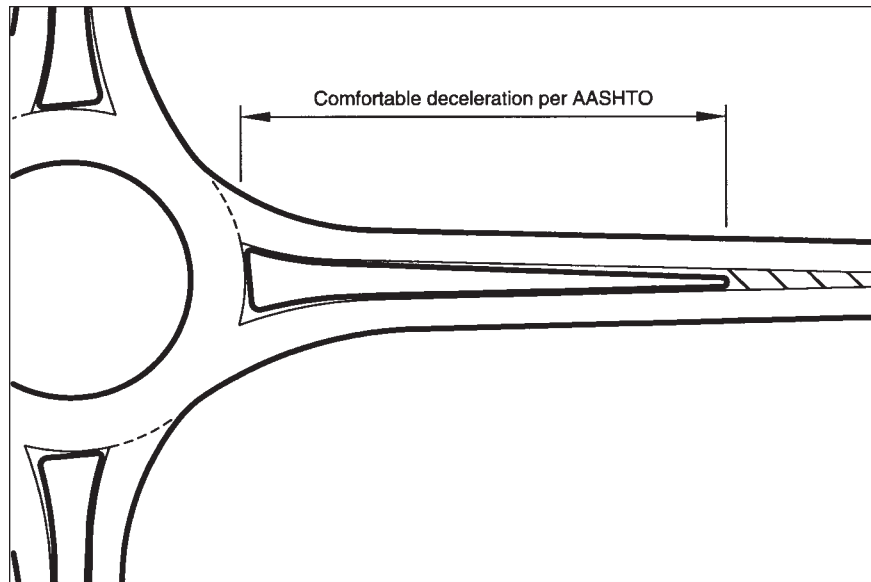

6.5.4 Approach curves

Roundabouts on high-speed roads (speeds of 80 km/h [50 mph] or higher), despite extra signing efforts, may not be expected by approaching drivers, resulting in erratic behavior and an increase in single-vehicle crashes. Good design encourages drivers to slow down before reaching the roundabout, and this can be most effectively achieved through a combination of geometric design and other design treatments (see Chapter 7). Where approach speeds are high, speed consistency on the approach needs to be addressed to avoid forcing all of the reduction in speed to be completed through the curvature at the roundabout.

The radius of an approach curve (and subsequent vehicular speeds) has a direct impact on the frequency of crashes at a roundabout. A study in Queensland, Australia, has shown that decreasing the radius of an approach curve generally decreases the approaching rear-end vehicle crash rate and the entering-circulating and exiting-circulating vehicle crash rates (see Chapter 5). On the other hand, decreasing the radius of an approach curve may increase the single-vehicle crash rate on the curve, particularly when the required side-friction for the vehicle to maintain its path is too high. This may encourage drivers to cut across lanes and increase sideswipe crash rates on the approach curve (2).

One method to achieve speed reduction that reduces crashes at the roundabout while minimizing single-vehicle crashes is the use of successive curves on approaches. The study in Queensland, Australia, found that by limiting the change in 85th-percentile speed on successive geometric elements to 20 km/h (12 mph), the crash rate was reduced. It was found that the use of successive reverse curves prior to the roundabout approach curve reduced the single-vehicle crash rate and the sideswipe crash rate on the approach. It is recommended that approach speeds immediately prior to the entry curves of the roundabout be limited to 60 km/h (37 mph) to minimize high-speed rear-end and entering-circulating vehicle crashes.

Exhibit 6-49 shows a typical rural roundabout design with a succession of three curves prior to the yield line. As shown in the exhibit, these approach curves should be successively smaller radii in order to minimize the reduction in design speed between successive curves. The aforementioned Queensland study found that shifting the approaching roadway laterally by 7 m (23 ft) usually enables adequate curvature to be obtained while keeping the curve lengths to a minimum. If the lateral shift is too small, drivers are more likely to cut into the adjacent lane (2).

A series of progressively sharper curves on a high-speed roundabout approach helps slow traffic to an appropriate entry speed.

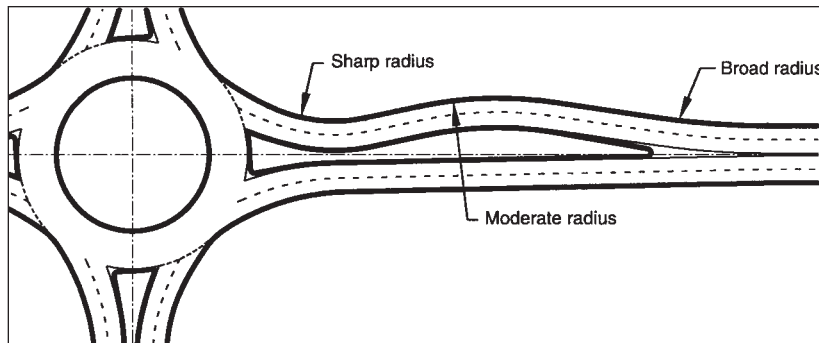

Exhibit 6-49. Use of successive curves on high speed approaches.

Equations 6-4 and 6-5 can be used to estimate the operating speed of two-lane rural roads as a function of degree of curvature. Equation 6-6 can be used similarly for four-lane rural roads (13).

Two-lane rural roads:

$$V_{85} = 103.66 - 1.95D, D \geq 3^\circ \quad (6-4)$$

$$V_{85} = 97.9, D < 3^\circ \quad (6-5)$$

where: V_{85} = 85th-percentile speed, km/h (1 km/h = 0.621 mph); and
 D = degree of curvature, degrees = $1746.38 / R$
 R = radius of curve, m

Four-lane rural roads:

$$V_{85} = 103.66 - 1.95D \quad (6-6)$$

where: V_{85} = 85th-percentile speed, km/h (1 km/h = 0.621 mph); and
 D = degree of curvature, degrees = $1746.38 / R$
 R = radius of curve, m

6.6 Mini-Roundabouts

As discussed in Chapter 1, a mini-roundabout is an intersection design alternative that can be used in place of stop control or signalization at physically constrained intersections to help improve safety problems and excessive delays at minor approaches. Mini-roundabouts are not traffic calming devices but rather are a form of roundabout intersection. Exhibit 6-50 presents an example of a mini-roundabout.

Mini-roundabouts are not recommended where approach speeds are greater than 50 km/h (30 mph), nor in locations with high U-turning volumes.

Exhibit 6-50. Example of a mini-roundabout.

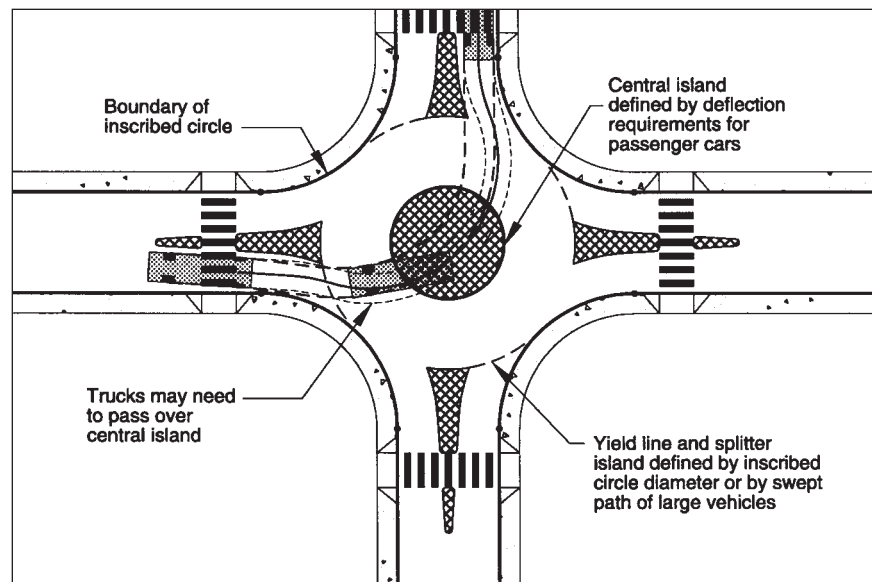

Mini-roundabouts should only be considered in areas where all approaching roadways have an 85th-percentile speed of less than 50 km/h (30 mph). In addition, mini-roundabouts are not recommended in locations in which high U-turn traffic is expected, such as at the ends of street segments with access restrictions. Mini-roundabouts are not well suited for high volumes of trucks, as trucks will occupy most of the intersection when turning.

The central island of a mini-roundabout should be clear and conspicuous.

The design of the central island of a mini-roundabout is defined primarily by the requirement to achieve speed reduction for passenger cars. As discussed previously in Section 6.2, speed reduction for entering vehicles and speed consistency with circulating vehicles are important. Therefore, the location and size of the central island are dictated by the inside of the swept paths of passenger cars that is needed to achieve a maximum recommended entry speed of 25 km/h (15 mph). The central island of a mini-roundabout is typically a minimum of 4 m (13 ft) in diameter and is fully mountable by large trucks and buses. Composed of asphalt, concrete, or other paving material, the central island should be domed at a height of 25 to 30 mm per 1 m diameter (0.3 to 0.36 in per 1 ft diameter), with a maximum height of 125 mm (5 in) (14). Although fully mountable and relatively small, it is essential that the central island be clear and conspicuous (14, 15). Chapter 7 provides a sample signing and striping planing plan for mini-roundabout.

The outer swept path of passenger cars and large vehicles is typically used to define the location of the yield line and boundary of each splitter island with the circulatory roadway. Given the small size of a mini-roundabout, the outer swept path of large vehicles may not be coincident with the inscribed circle of the roundabout, which is defined by the outer curbs. Therefore, the splitter islands and yield line may extend into the inscribed circle for some approach geometries. On the other hand, for very small mini-roundabouts, such as the one shown in Exhibit 6-50, all turning trucks will pass directly over the central island while not encroaching on the circulating roadway to the left which may have opposing traffic. In these cases, the yield line and splitter island should be set coincident with the inscribed

6.7 References

1. Department of Transport of Northrhine-Westfalia, Germany. *Empfehlungen zum Einsatz und zur Gestaltung von Mini-Kreisverkehrsplaetzen (Guidelines for the Use and Design of Mini-Roundabouts)*. Dusseldorf, Germany, 1999.
2. Queensland Department of Main Roads (QDMR). *Relationships between Roundabout Geometry and Accident Rates*. Queensland, Australia: Infrastructure Design of the Technology Division of QDMR, April 1998.
3. Department of Transport (United Kingdom). *Geometric Design of Roundabouts*. TD 16/93. September 1993.
4. American Association of State Highway and Transportation Officials (AASHTO). *A Policy on Geometric Design of Highways and Streets*. Washington, D.C.: AASHTO, 1994.
5. Pein, W.E. *Trail Intersection Design Guidelines*. Prepared for State Bicycle/Pedestrian Program, State Safety Office, Florida Department of Transportation. Highway Safety Research Center, University of North Carolina, September 1996.
6. Service d'Etudes Techniques des Routes et Autoroutes (SETRA—Center for Technical Studies of Roads and Highways). *Aménagement des Carrefours Interurbains sur les Routes Principales (Design of Rural Intersections on Major Roads)*. Ministry of Transport and Housing, December 1998.
7. *Americans with Disabilities Act Accessibility Guidelines for Buildings and Facilities (ADAAG)*. 36 CFR Part 1191. As amended through January 1998.
8. Fambro, D.B., et al. *NCHRP Report 400: Determination of Stopping Sight Distances*. National Cooperative Highway Research Program, Transportation Research Board, National Research Council. Washington, D.C.: National Academy Press, 1997.
9. Harwood, D.W., et al. *NCHRP Report 383: Intersection Sight Distances*. National Cooperative Highway Research Program, Transportation Research Board, National Research Council. Washington, D.C.: National Academy Press, 1996.
10. Austroads. *Guide to Traffic Engineering Practice, Part 6—Roundabouts*. Sydney, Australia: Austroads, 1993.
11. Florida Department of Transportation. *Florida Roundabout Guide*. Florida Department of Transportation, March 1996.
12. American Association of State Highway and Transportation Officials (AASHTO). *Guide for Development of Bicycle Facilities*. Washington, D.C.: AASHTO, 1991.
13. Krammes, R., et al. *Horizontal Alignment Design Consistency for Rural Two-Lane Highways*. Publication No. FHWA-RD-94-034. Washington, D.C.: Federal Highway Administration, January 1995.
14. Sawers, C. *Mini-roundabouts: Getting them right!*. Canterbury, Kent, United Kingdom: Euro-Marketing Communications, 1996.
15. Brilon, W., and L. Bondzio. *Untersuchung von Mini-Kreisverkehrsplaetzen (Investigation of Mini-Roundabouts)*. Ruhr-University Bochum, Germany, 1999.



Traffic Design and Landscaping

7.1	Signing	185
7.1.1	Relationship with the <i>Manual on Uniform Traffic Control Devices</i>	185
7.1.2	Regulatory signs	186
7.1.3	Warning signs	188
7.1.4	Guide signs	191
7.1.5	Urban signing considerations	192
7.1.6	Rural and suburban signing considerations	194
7.1.7	Mini-roundabout signing considerations	195
7.2	Pavement Markings	197
7.2.1	Relationship with the <i>Manual on Uniform Traffic Control Devices</i>	197
7.2.2	Approach and entry pavement markings	197
7.2.3	Circulatory roadway pavement markings	200
7.2.4	Mini-roundabout pavement markings	201
7.3	Illumination	202
7.3.1	Need for illumination	202
7.3.2	Standards and recommended practices	203
7.3.3	General recommendations	204
7.3.4	Clear zone requirements	205
7.4	Work Zone Traffic Control	205
7.4.1	Pavement markings	205
7.4.2	Signing	205
7.4.3	Lighting	206

7.4.4	Construction staging	206
7.4.5	Public education	207
7.5	Landscaping	207
7.5.1	Advantages	207
7.5.2	Central island landscaping	208
7.5.3	Splitter island and approach landscaping	208
7.5.4	Maintenance	209
7.6	References	209
Exhibit 7-1.	YIELD sign (R1-2).	186
Exhibit 7-2.	ONE WAY sign (R6-1R).	186
Exhibit 7-3.	KEEP RIGHT sign (R4-7).	186
Exhibit 7-4.	Lane-use control signing for roundabouts with double-lane entries.	188
Exhibit 7-5.	Lane-use control signing for roundabouts with heavy turning traffic.	188
Exhibit 7-6.	Circular Intersection sign (W2-6).	189
Exhibit 7-7.	Advisory speed plate (W13-1).	189
Exhibit 7-8.	Roundabout Ahead sign.	189
Exhibit 7-9.	YIELD AHEAD sign (W3-2a).	189
Exhibit 7-10.	Large Arrow sign (W1-6).	190
Exhibit 7-11.	Chevron plate (W1-8a).	190
Exhibit 7-12.	Pedestrian Crossing sign (W11-2a).	190
Exhibit 7-13.	Examples of advance destination guide signs.	191
Exhibit 7-14.	Exit guide sign (D1-1).	192
Exhibit 7-15.	Sample signing plan for an urban roundabout.	193
Exhibit 7-16.	Sample signing plan for a rural roundabout.	194
Exhibit 7-17.	Examples of speed reduction treatments.	195
Exhibit 7-18.	Sample signing plan for a mini-roundabout.	196
Exhibit 7-19.	Examples of yield lines.	198
Exhibit 7-20.	Approach pavement markings.	199
Exhibit 7-21.	Sample pavement marking plan for a mini-roundabout.	201
Exhibit 7-22.	Illumination of a roundabout.	202
Exhibit 7-23.	Recommended street illumination levels.	204
Exhibit 7-24.	Landscaping of the central island.	208

Chapter 7 **Traffic Design and Landscaping**

This chapter presents guidelines on the design of traffic elements, illumination, and landscaping associated with roundabouts. The design of these elements is critical in achieving the desired operational and safety features of a roundabout, as well as the desired visibility and aesthetics. This chapter is divided into the following sections:

- Signing;
- Pavement Markings;
- Illumination;
- Work Zone Traffic Control; and
- Landscaping.

Signing, striping, illumination, and landscaping are the critical finishing touches for an effectively functioning roundabout.

7.1 Signing

The overall concept for roundabout signing is similar to general intersection signing. Proper regulatory control, advance warning, and directional guidance are required to avoid driver expectancy related problems. Signs should be located where they have maximum visibility for road users but a minimal likelihood of even momentarily obscuring pedestrians as well as motorcyclists and bicyclists, who are the most vulnerable of all roundabout users. Signing needs are different for urban and rural applications and for different categories of roundabouts.

7.1.1 Relationship with the *Manual on Uniform Traffic Control Devices*

The *Manual on Uniform Traffic Control Devices for Streets and Highways* (MUTCD) (1) and *Standard Highway Signs* (2), as well as local applicable standards, govern the design and placement of signs. To the extent possible, this guide has been prepared in accordance with the 1988 edition of the MUTCD. However, roundabouts present a number of new signing issues that are not addressed in the 1988 edition. For this reason, a number of new signs or uses for existing signs have been introduced that are under consideration for inclusion in the next edition of the MUTCD. Until such signs or uses are formally adopted, these recommendations should be considered provisional and are subject to MUTCD Section 1A-6, "Manual Changes, Interpretations and Authority to Experiment."

The following signs and applications recommended below are subject to these conditions:

- Use of YIELD signs on more than one approach to an intersection (Section 7.1.2.1);
- Long chevron plate (Section 7.1.2.2);
- Roundabout Ahead sign (Section 7.1.3.1);
- Advance diagrammatic guide signs (Section 7.1.4.1); and
- Exit guide signs (Section 7.1.4.2).

7.1.2 Regulatory signs

A number of regulatory signs are appropriate for roundabouts and are described below.

7.1.2.1 YIELD sign

YIELD signs are required on all approaches.

A YIELD sign (R1-2), shown in Exhibit 7-1, is required at the entrance to the roundabout. For single-lane approaches, one YIELD sign placed on the right side is sufficient, although a second YIELD sign mounted in the splitter island on the left side of the approach may be used. For approaches with more than one lane, the designer should place YIELD signs on both the left and right sides of the approach. This practice is consistent with the recommendations of the MUTCD on the location of STOP and YIELD signs on single-lane and multilane approaches (MUTCD, §2B-9). To prevent circulating vehicles from yielding unnecessarily, the face of the yield sign should not be visible from the circulatory roadway. YIELD signs may also be used at the entrance to crosswalks on both the entry and exit legs of an approach. However, the designer should not use both YIELD signs and Pedestrian Crossing signs (see Section 7.1.3.5) to mark a pedestrian crossing, as the yield signs at the roundabout entrance may be obscured.

Exhibit 7-1. YIELD sign (R1-2).



7.1.2.2 ONE WAY sign

ONE WAY signs establish the direction of traffic flow within the roundabout.

ONE WAY signs (R6-1R) may be used in the central island opposite the entrances. An example is shown in Exhibit 7-2. The ONE WAY sign may be supplemented with chevron signs to emphasize the direction of travel within the circulatory roadway (see Section 7.1.3.4).

At roundabouts with one-way streets on one or more approaches, the use of a regulatory ONE WAY sign may be confusing. In these cases, a Large Arrow warning sign (see Section 7.1.3.3) may be used.

Exhibit 7-2. ONE WAY sign (R6-1R).



7.1.2.3 KEEP RIGHT sign

KEEP RIGHT signs (R4-7 or text variations R4-7a and R4-7b) should be used at the nose of all nonmountable splitter islands. This sign is shown in Exhibit 7-3.

For small splitter islands, a Type 1 object marker may be substituted for the KEEP RIGHT sign. This may reduce sign clutter and improve the visibility of the YIELD sign.

Exhibit 7-3. KEEP RIGHT sign (R4-7).



7.1.2.4 Lane-use control signs

For roundabouts with multiple entry lanes, it can often be confusing for unfamiliar drivers to know which lanes to use for the various left, through, and right movements. There is no international consensus on the effectiveness of lane-use signs and/or pavement markings.

Lane-use control signs are generally not recommended.

The designation of lanes on entry to a roundabout is directly related to a number of factors:

- *Traffic volume balance.* Roundabouts with especially heavy left- or right-turning traffic may require more than one lane to handle the expected demand (see Chapter 4).
- *Exit lane requirements.* In general, the number of exit lanes provided should be the minimum required to handle the expected exit volume. This may not correspond with the number of entry lanes on the opposite side of the roundabout that would use the exit as through vehicles (see Chapter 4).
- *The rules of the road.* Drivers have a reasonable expectation that multiple through lanes entering a roundabout will have an equal number of receiving lanes on exit on the far side of the roundabout (see Chapter 2).

Lane-use control signs are generally not required where the number of receiving lanes for through vehicles on exit matches the number of entry lanes, as shown in Exhibit 7-4. Lane-use control signs should be used only for the following conditions:

- Where only a single exit lane is provided to receive two lanes of vehicles making through movements, lane-use designations should be made to indicate that an entry lane drops as a turning movement (see Exhibit 7-4). This does not include cases where an approach is flared from one to two lanes at the roundabout.
- Where left- or right-turning traffic demand dictates the need for more than one left-turn lane or more than one right-turn lane for capacity reasons (see Exhibit 7-5).

The use of a left-turn-only lane designation as shown in the exhibits may be initially confusing to drivers. This type of designation has worked successfully in other countries, and there is no evidence to suggest that it will not work in the United States. However, given the general unfamiliarity of roundabouts to drivers in the United States at this time, it is recommended that double-lane roundabouts be designed to avoid the use of lane-use control signs wherever possible, at least until drivers become more accustomed to driving roundabouts.

Exhibit 7-4. Lane-use control signing for roundabouts with double-lane entries.

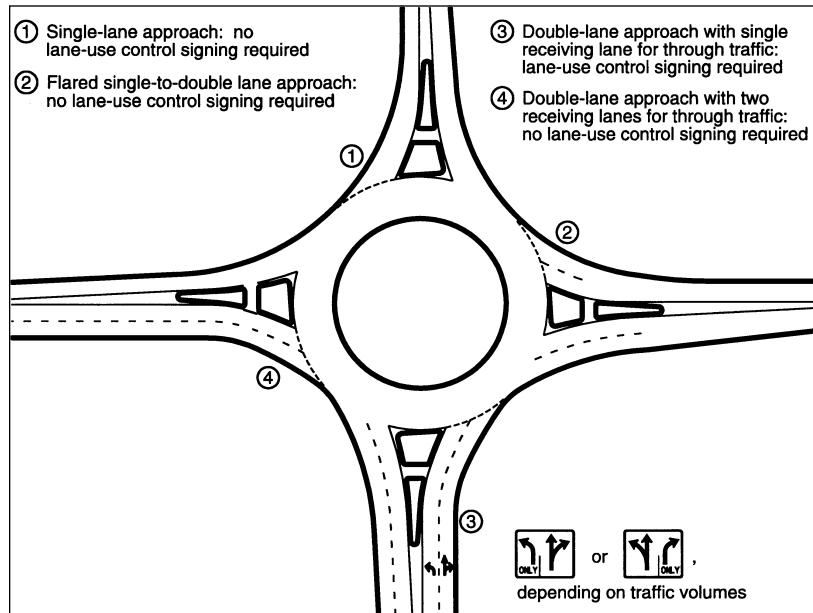
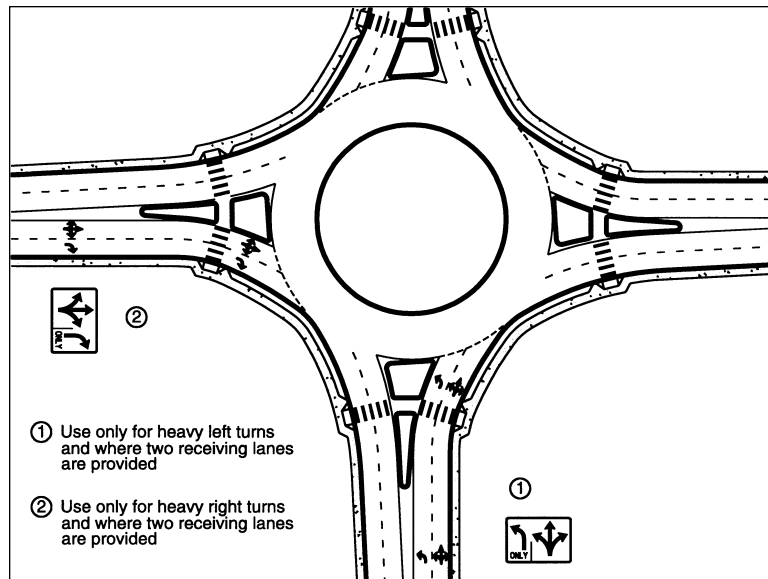

Exhibit 7-5. Lane-use control signing for roundabouts with heavy turning traffic.



7.1.3 Warning signs

A number of warning signs are appropriate for roundabouts and are described below. The amount of warning a motorist needs is related to the intersection setting and the vehicular speeds on approach roadways. The specific placement of warning signs is governed by the applicable sections of the MUTCD.

7.1.3.1 Circular Intersection sign

A Circular Intersection sign (W2-6) may be installed on each approach in advance of the roundabout. This sign, given in Exhibit 7-6, is proposed as part of the next edition of the MUTCD. When used, it is recommended that this sign be modified to reflect the number and alignment of approaches.



Exhibit 7-6. Circular Intersection sign (W2-6).

It is also recommended that an advisory speed plate (W13-1) be used with this sign, as shown in Exhibit 7-7. The speed given on the advisory speed plate should be no higher than the design speed of the circulatory roadway, as determined in Chapter 6.



Exhibit 7-7. Advisory speed plate (W13-1).

An alternative to the Circular Intersection sign, called a Roundabout Ahead sign, has been proposed and is shown in Exhibit 7-8. The rationale for this sign is given in Appendix C. At a minimum it is recommended that the Roundabout Ahead sign be used in place of the Circular Intersection sign at mini-roundabouts (see Section 7.1.7).



Exhibit 7-8. Roundabout Ahead sign.

7.1.3.2 YIELD AHEAD sign

A YIELD AHEAD sign (W3-2 or W3-2a) should be used on all approaches to a roundabout in advance of the yield sign. These signs provide drivers with advance warning that a YIELD sign is approaching. The preferred symbolic form of this sign is shown in Exhibit 7-9.

YIELD AHEAD signs warn drivers of the upcoming YIELD sign.



Exhibit 7-9. YIELD AHEAD sign (W3-2a).

71.3.3 Large Arrow sign

A Large Arrow sign with a single arrow pointing to the right (W1-6) should be used in the central island opposite the entrances, unless a regulatory ONE-WAY sign has been used. The Large Arrow sign is shown in Exhibit 7-10.

Exhibit 7-10. Large Arrow sign (W1-6).



71.3.4 Chevron Plate

Chevron plates can be especially useful for nighttime visibility for sites without illumination.

The Large Arrow may be supplemented or replaced by a long chevron board (W1-8a), as proposed in the next edition of the MUTCD) to emphasize the direction of travel within the circulatory roadway.

Exhibit 7-11. Chevron plate (W1-8a).



71.3.5 Pedestrian Crossing

Pedestrian Crossing signs (W11-2a) may be used at pedestrian crossings within a roundabout at both entries and exits. Pedestrian Crossing signs should be used at all pedestrian crossings at double-lane entries, double-lane exits, and right-turn bypass lanes. This sign is shown in Exhibit 7-12.

The use of Pedestrian Crossing signs is dependent on the specific laws of the governing state. If the crosswalk at a roundabout is not considered to be part of the intersection and is instead considered a marked midblock crossing, Pedestrian Crossing signs are required. Where installed, Pedestrian Crossing signs should be located in such a way to not obstruct view of the YIELD sign.

Exhibit 7-12. Pedestrian Crossing sign (W11-2a).



7.1.4 Guide signs

Guide signs are important in providing drivers with proper navigational information. This is especially true at roundabouts where out-of-direction travel may disorient unfamiliar drivers. A number of guide signs are appropriate for roundabouts and are described below.

7.1.4.1 Advance destination guide signs

Advance destination guide signs should be used in all rural locations and in urban/suburban areas where appropriate. The sign should be either a destination sign using text (D1-3) or using diagrams. Examples of both are shown in Exhibit 7-13. Diagrammatic signs are preferred because they reinforce the form and shape of the approaching intersection and make it clear to the driver how they are expected to navigate the intersection. Advance destination guide signs are not necessary at local street roundabouts or in urban settings where the majority of traffic tends to be familiar with the site.

The circular shape in a diagrammatic sign provides an important visual cue to all users of the roundabout.



Leeds, MD



Taneytown, MD



Lothian, MD



Long Beach, CA

Exhibit 7-13. Examples of advance destination guide signs.

Diagrammatic Style (Preferred)

Exit guide signs reduce the potential for disorientation.

7.1.4.2 Exit guide signs

Exit guide signs (D1-1) are recommended to designate the destinations of each exit from the roundabout. These signs are conventional intersection direction signs or directional route marker assemblies and can be placed either on the right-hand side of the roundabout exit or in the splitter island. An example is shown in Exhibit 7-14.

Exhibit 7-14. Exit guide sign (D1-1).



7.1.4.3 Route confirmation signs

For roundabouts involving the intersection of one or more numbered routes, route confirmation assemblies should be installed directly after the roundabout exit. These provide drivers with reassurance that they have selected the correct exit at the roundabout. These assemblies should be located no more than 30 m (100 ft) beyond the intersection in urban areas and 60 m (200 ft) beyond the intersection in rural areas.

7.1.5 Urban signing considerations

The designer needs to balance the need for adequate signing with the tendency to use too many signs.

The amount of signing required at individual locations is largely based on engineering judgment. However, in practice, the designer can usually use fewer and smaller signs in urban settings than in rural settings. This is true because drivers are generally traveling at lower vehicular speeds and have higher levels of familiarity at urban intersections. Therefore, in many urban settings the advance destination guide signs can be eliminated. However, some indication of street names should be included in the form of exit guide signs or standard street name signs. Another consideration in urban settings is the use of minimum amounts of signing to avoid sign clutter. A sample signing plan for an urban application is shown in Exhibit 7-15.

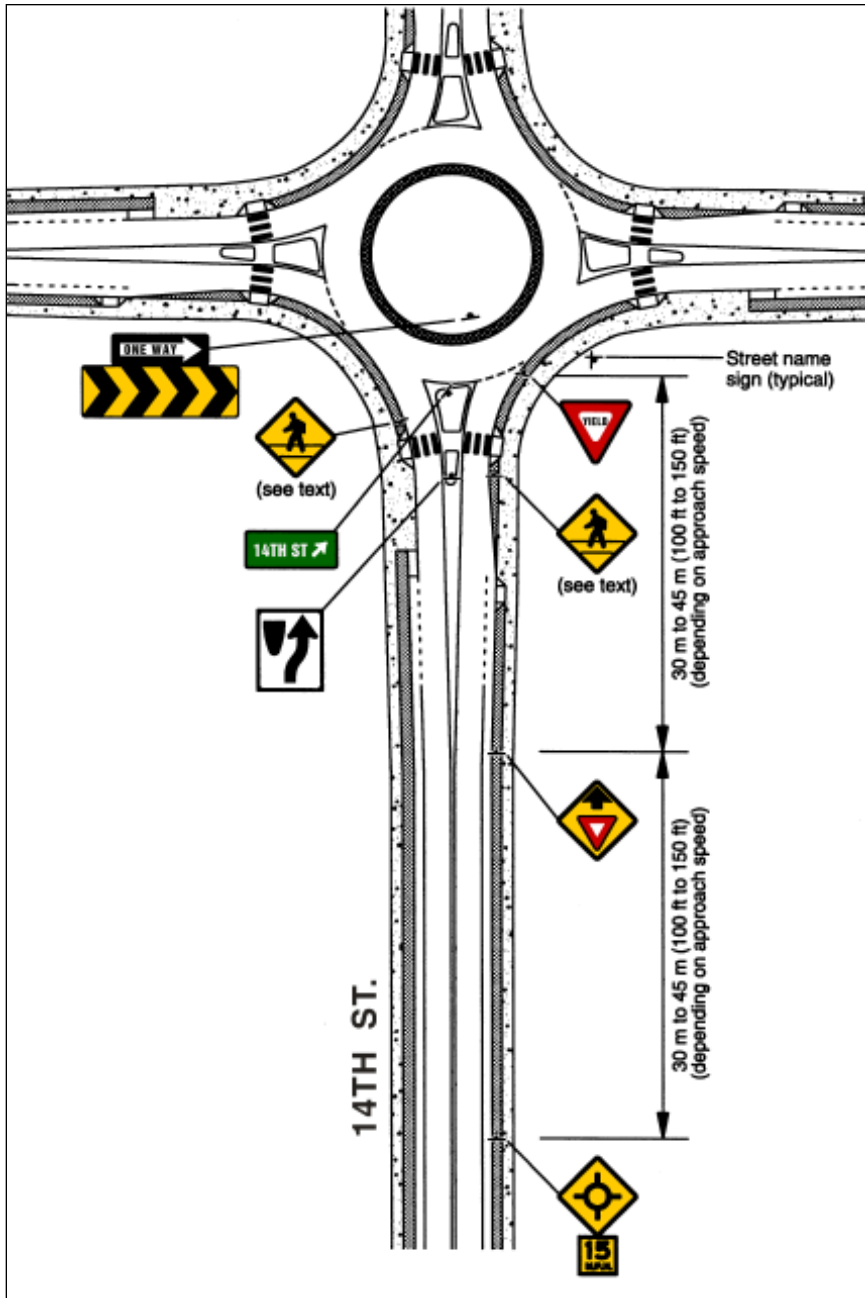

Exhibit 7-15. Sample signing plan for an urban roundabout.

7.1.6 Rural and suburban signing considerations

Rural signing needs to be more conspicuous than urban signing due to higher approach speeds.

Rural and suburban conditions are characterized by higher approach speeds. Route guidance tends to be focused more on destinations and numbered routes rather than street names. A sample signing plan for a rural application is shown in Exhibit 7-16.

Exhibit 7-16. Sample signing plan for a rural roundabout.

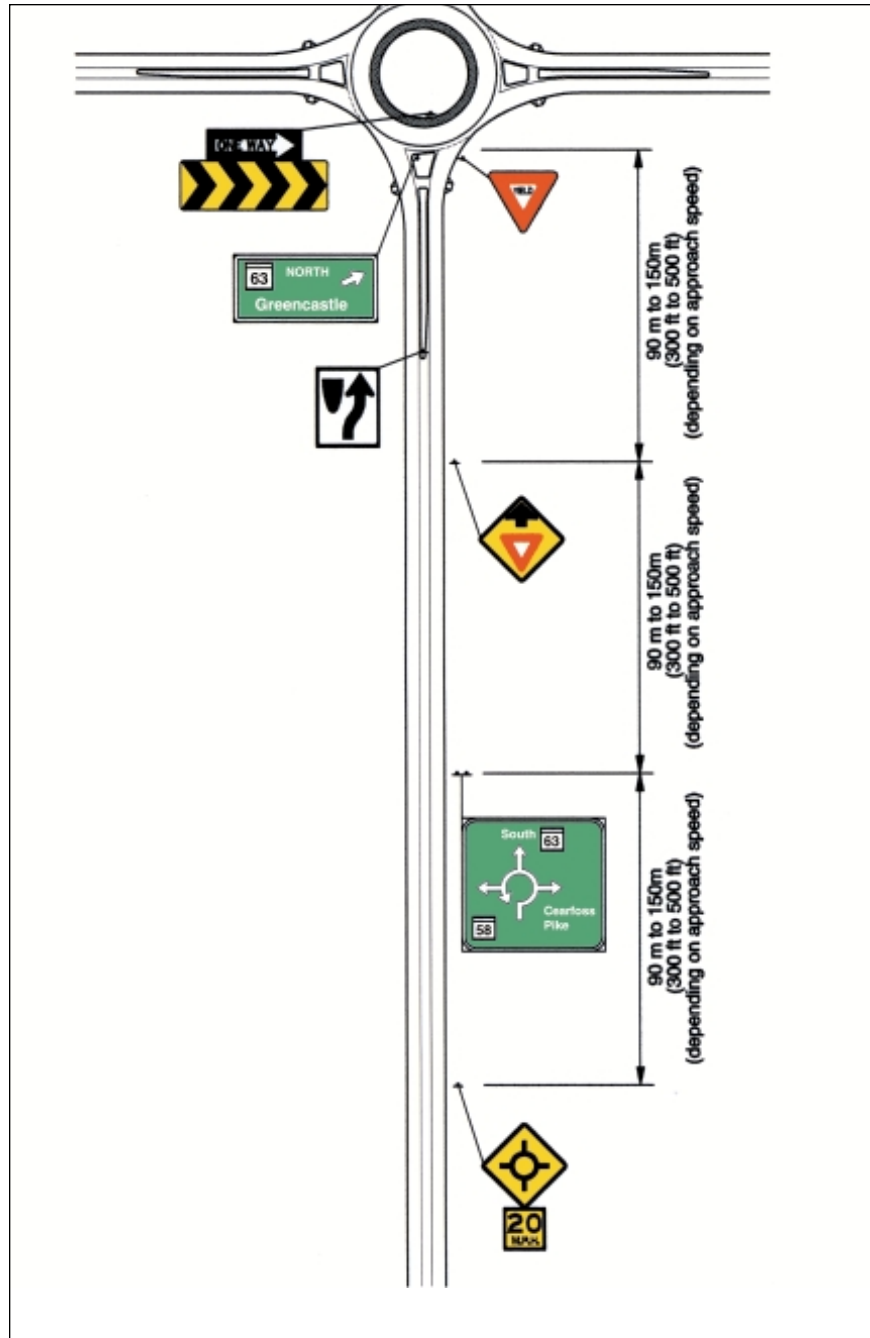

In cases where high speeds are expected (in excess of 80 km/h [50 mph]) and the normal signage and geometric features are not expected to produce the desired reduction in vehicle speeds, the following measures may also be considered (examples of some of these treatments are given in Exhibit 7-17):

- Large advance warning signs;
- Addition of hazard identification beacons to approach signing;
- Use of rumble strips in advance of the roundabout;
- Pavement marking across pavement; and
- Use of speed warning signs. These can be triggered by speeds exceeding an acceptable threshold.



Warning beacons. *Leeds, MD*

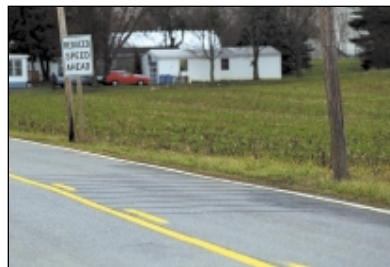

Rumble strips. *Cearfoss, MD*



Speed warning signs. *Leeds, MD*

These speed reduction treatments can apply to all intersection types, not just roundabouts.

Exhibit 7-17. Examples of speed reduction treatments.

7.1.7 Mini-roundabout signing considerations

Due to their small size and unique features, mini-roundabouts require a somewhat different signing treatment than the larger urban roundabouts. The principal differences in signing at mini-roundabouts as compared to other urban roundabouts are the following:

- The central island is fully mountable. Therefore, no ONE WAY signs, Large Arrow signs, or chevrons can be located there. It is recommended that the direction of circulation be positively indicated through the use of pavement markings, as discussed in Section 7.2.4.
- The splitter islands are either painted or are fully mountable. Therefore, KEEP RIGHT signs are not appropriate for mini-roundabouts.

- Typically, advance directional guide signs and exit guide signs are unnecessary, given the size of the mini-roundabout and the nature of the approach roadways (generally low-speed local streets). However, standard street name signs (D3) should be used.
- The Roundabout Ahead warning sign discussed in Section 7.1.3.1 should be used on each approach in advance of the YIELD sign. The Circular Intersection warning gives no indication of the direction of circulation required at the mini-roundabout.

Exhibit 7-18 gives a sample signing plan for a mini-roundabout.

Exhibit 7-18. Sample signing plan for a mini-roundabout.

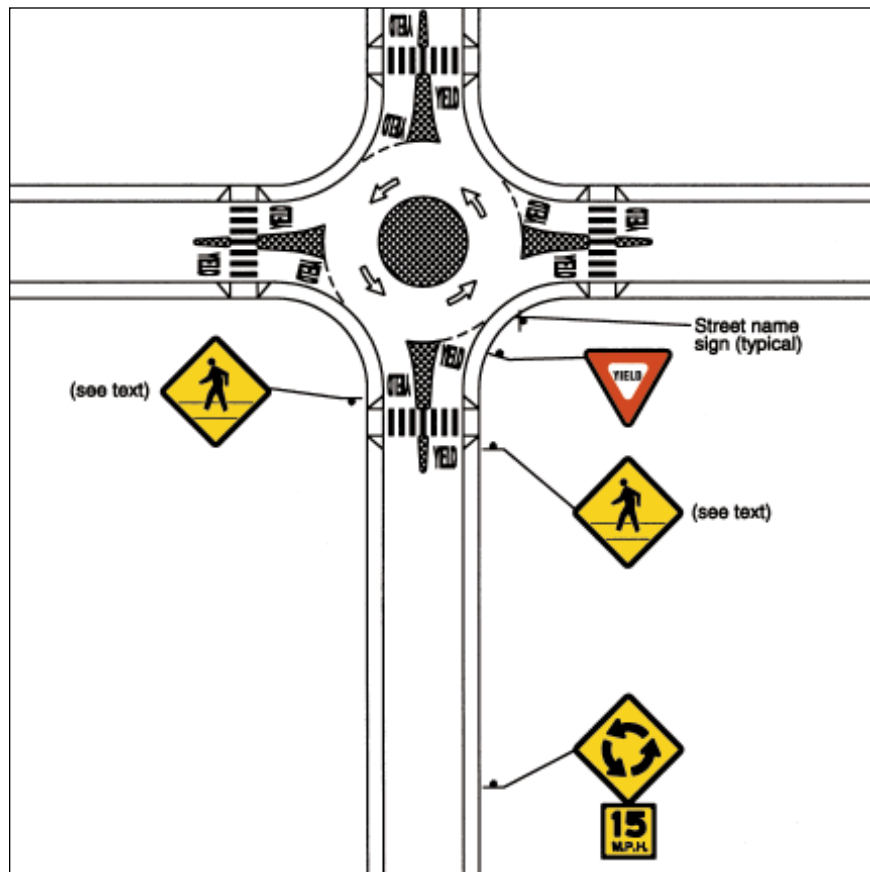

7.2 Pavement Markings

Typical pavement markings for roundabouts consist of delineating the entries and the circulatory roadway.

7.2.1 Relationship with the *Manual on Uniform Traffic Control Devices*

As with signing, the MUTCD (1) and applicable local standards govern the design and placement of pavement markings. Roundabouts present a number of new pavement marking issues that are not addressed in the 1988 edition of the MUTCD. For this reason, a number of new pavement markings or uses for existing pavement markings have been introduced that are under consideration for inclusion in the next edition of the MUTCD. Until such pavement markings or uses are formally adopted, these recommendations should be considered provisional and are subject to MUTCD Section 1A-6, “Manual Changes, Interpretations and Authority to Experiment.”

The following pavement markings and applications recommended below are subject to these conditions:

- YIELD lines (Section 7.2.2.1); and
- Symbolic YIELD legend (Section 7.2.2.2).

7.2.2 Approach and entry pavement markings

Approach and entry pavement markings consist of yield lines, pavement word and symbol markings, and channelization markings. In addition, multilane approaches require special attention to pavement markings. The following sections discuss these in more detail.

7.2.2.1 Yield lines

Yield lines should be used to demarcate the entry approach from the circulatory roadway. Yield lines should be located along the inscribed circle at all roundabouts except mini-roundabouts (see Section 7.2.4). No yield lines should be placed to demarcate the exit from the circulatory roadway.

The MUTCD currently provides no standard for yield lines. The recommended yield line pavement marking is a broken line treatment consisting of 400-mm (16-in) wide stripes with 1-m (3-ft) segments and 1-m (3-ft) gaps. This type of yield line is the simplest to install.

Alternatively, several European countries use a yield line marking consisting of a series of white triangles (known as “shark’s teeth”). These markings tend to be more visible to approaching drivers. Exhibit 7-19 presents examples of broken line and “shark’s teeth” yield line applications. The “shark’s teeth” ahead of the broken line has been recommended for adoption in the next edition of the MUTCD.

Yield lines provide a visual separation between the approach and the circulatory roadway.

“Shark’s teeth” provide more visual “punch” but require a new template for installation.

Exhibit 7-19. Examples of yield lines.



Broken line. *Leeds, MD*



"Shark's teeth." *Lothian, MD*

Pavement word markings are less effective in rainy or especially snowy climates.

7.2.2.2 Pavement word and symbol markings

In some cases, the designer may want to consider pavement word or symbol markings to supplement the signing and yield line marking. This typically consists of the word YIELD painted on the entrance to the roundabout immediately prior to the yield line. These markings should conform to the standards given in the appropriate section of the MUTCD (§3B-20).

Alternatively, some European countries paint a symbolic yield sign upstream of the yield line. This treatment has the advantage of being symbolic; however, such a treatment has not seen widespread use in the United States to date.

7.2.2.3 Lane-use control markings

If lane-use control signing has been used to designate specific lane use on an approach with more than one lane, it is recommended that corresponding arrow legends be used within each lane. See Section 7.1.2.4 for more discussion of the use of lane-use controls.

7.2.2.4 Approach markings

Typically, pavement markings are provided around raised splitter islands and right-turn bypass islands to enhance driver recognition of the changing roadway. Channelization markings shall be yellow when to the left of the traffic stream and white when to the right of the traffic stream. For a roundabout splitter island, pavement markings shall be yellow adjacent to the entry and exit and white adjacent to the circulatory roadway. Exhibit 7-20 presents a recommended pavement marking plan for the channelization on a typical single-lane approach to a roundabout. Optionally, edge stripes may end at the points of the splitter islands, allowing the curbs themselves to provide edge delineation.

Raised pavement markers are useful supplements to pavement markings.

Raised pavement markers are generally recommended for supplementing pavement markings. These have the benefit of additional visibility at night and in inclement weather. However, they increase maintenance costs and can be troublesome in areas requiring frequent snow removal. In addition, raised pavement markers should not be used in the path of travel of bicycles.

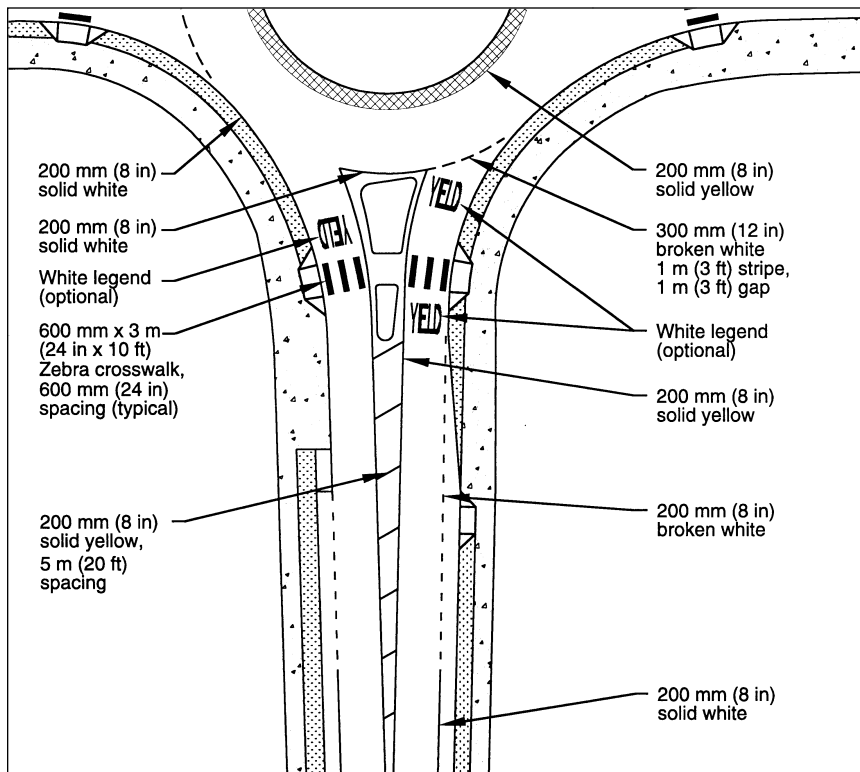

Exhibit 7-20. Approach pavement markings.

For small splitter islands (in area less than 7 m² [75 ft²]), the island may consist of pavement markings only. However, where possible, curbed splitter islands should be used.

7.2.2.5 Pedestrian crosswalk markings

Pedestrian crosswalk markings should generally be installed at all pedestrian crossing locations within roundabouts in urban locations. Because the crosswalk at a roundabout is located away from the yield line, it is important to channelize pedestrians to the appropriate crossing location. These markings should not be construed as a safety device, as data from other countries suggest that the presence of markings has no appreciable effect on pedestrian safety. Rather, markings provide guidance for pedestrians in navigating a roundabout and provide a visual cue to drivers of where pedestrians may be within the roadway. The use of crosswalk markings in this manner is consistent with published recommendations (3). Marked crosswalks are generally not needed at locations where the crosswalk is distinguished from the roadway by visually contrasting pavement colors and textures.

A crosswalk marking using a series of lines parallel to the flow of traffic (known as a “zebra crosswalk”) is recommended. These lines should be approximately 0.3 m to 0.6 m (12 in to 24 in) wide, spaced 0.3 m to 1.0 m (12 in to 36 in) apart, and span the width of the crosswalk (similar to the recommendations in MUTCD §3B-18). Crosswalk markings should be installed across both the entrance and exit of each leg and across any right turn bypass lanes. The crosswalk should be aligned with

Zebra crosswalks provide an important visual cue for drivers and pedestrians.

the ramps and pedestrian refuge in the splitter island and have markings that are generally perpendicular to the flow of vehicular traffic.

The zebra crosswalk has a number of advantages over the traditional transverse crosswalk marking in roundabout applications:

- Because the crosswalk at a roundabout is set back from the yield line, the zebra crosswalk provides a higher degree of visibility.
- The zebra crosswalk is distinct from traditional transverse crosswalk markings typically used at signalized intersections, thus alerting both drivers and pedestrians that this intersection is different from a signalized intersection.
- The zebra crosswalk is also less likely to be confused with the yield line than a transverse crosswalk.
- Although the initial cost is somewhat higher, the zebra crossing may require less maintenance due to the ability to space the markings to avoid vehicle tire tracks.

In rural locations where pedestrian activity is expected to be minimal, pedestrian crosswalk markings are optional. Pedestrian crosswalk markings should not be used at roundabouts without illumination (see Section 7.3 for an identification of these cases) because the headlights of vehicles may not be sufficient to illuminate a pedestrian in time to avoid a collision (4). Regardless of whether the crosswalk is marked, all roundabouts with any reasonable possibility of pedestrian activity should have geometric features to accommodate pedestrians as described in Chapter 6.

In addition to pavement markings, flashing warning lights mounted in the pavement and activated by a pedestrian push button or other method may be considered. These are not part of the current MUTCD and thus must be treated as an experimental traffic control device (see Section 7.2.1).

7.2.2.6 *Bike lane markings*

Bicycle striping treatments should be used when an existing (or proposed) bike lane is part of the roadway facility. Exhibit 7-20 shows a recommended treatment for bike lanes on an approach to a roundabout.

7.2.3 **Circulatory roadway pavement markings**

Circulatory pavement markings are generally not recommended.

In general, lane lines should not be striped within the circulatory roadway, regardless of the width of the circulatory roadway. Circulatory lane lines can be misleading in that they may provide drivers a false sense of security.

Bike lanes within the roundabout are not recommended.

In addition, bike lane markings within the circulatory roadway are not recommended. The additional width of a bike lane within the circulatory roadway increases vehicular speed and increases the probability of motor vehicle-cyclist crashes. Bicyclists should circulate with other vehicles, travel through the roundabout as a pedestrian on the sidewalk, or use a separate shared-use pedestrian and bicycle facility where provided.

7.2.4 Mini-roundabout pavement markings

Mini-roundabouts require pavement marking treatments that are somewhat different from other urban roundabouts. The following pavement marking treatments are recommended for mini-roundabouts.

- Pavement marking arrows should be provided in the circulatory roadway in front of each entry to indicate the direction of circulation. As noted in the discussion of signing treatments (Section 7.1.7), no signs can be placed in the fully mountable central island.
- At a minimum, the edges of the mountable central island and splitter islands should be painted to improve their visibility.

A sample pavement marking plan for a mini-roundabout is given in Exhibit 7-21.

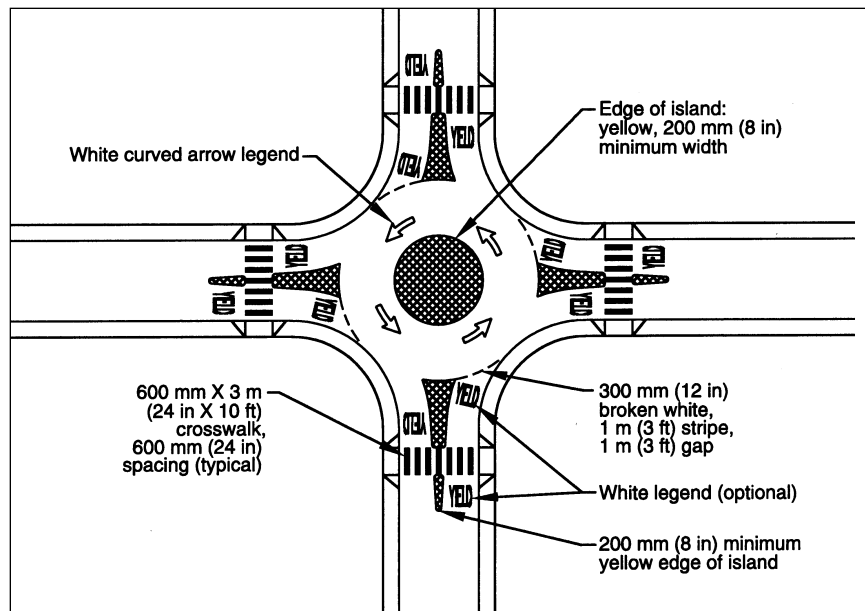

Exhibit 7-21. Sample pavement marking plan for a mini-roundabout.

7.3 Illumination

For a roundabout to operate satisfactorily, a driver must be able to enter the roundabout, move through the circulating traffic, and separate from the circulating stream in a safe and efficient manner. To accomplish this, a driver must be able to perceive the general layout and operation of the intersection in time to make the appropriate maneuvers. Adequate lighting should therefore be provided at all roundabouts. Exhibit 7-22 shows an example of an illuminated roundabout at night.

Exhibit 7-22. Illumination of a roundabout.



Loveland, CO

7.3.1 Need for illumination

The need for illumination varies somewhat based on the location in which the roundabout is located.

7.3.1.1 Urban conditions

In urban settings, illumination should be provided for the following reasons:

- Most if not all approaches are typically illuminated.
- Illumination is necessary to improve the visibility of pedestrians and bicyclists.

7.3.1.2 Suburban conditions

For roundabouts in suburban settings, illumination is recommended. For safety reasons, illumination is necessary when:

- One or more approaches are illuminated.
- An illuminated area in the vicinity can distract the driver's view.
- Heavy nighttime traffic is anticipated.

Continuity of illumination must be provided between illuminated areas and the roundabout itself (5). An unlit roundabout with one or more illuminated approaches is dangerous. This is because a driver approaching on an unlit approach will be attracted to the illuminated area(s) and may not see the roundabout.

7.3.1.3 Rural conditions

For rural roundabouts, illumination is recommended but not mandatory. If there is no power supply in the vicinity of the intersection, the provision of illumination can be costly. When lighting is not provided, the intersection should be well signed and marked so that it can be correctly perceived by day and night. The use of reflective pavement markers and retroreflective signs (including chevrons supplementing the ONE-WAY signs) should be used when lighting cannot be installed in a cost-effective manner.

Where illumination can be provided, any raised channelization or curbing should be illuminated. In general, a gradual illumination transition zone of approximately 80 m (260 ft) should be provided beyond the final trajectory changes at each exit (5). This helps drivers adapt their vision from the illuminated environment of the roundabout back into the dark environment of the exiting roadway, which takes approximately 1 to 2 seconds. In addition, no short-distance dark areas should be allowed between two consecutive illuminated areas (5).

7.3.2 Standards and recommended practices

The following standards and recommended practices should be consulted in completing the lighting plan:

- AASHTO, *An Information Guide for Roadway Lighting* (6). This is the basic guide for highway lighting. It includes information on warranting conditions and design criteria.
- AASHTO, *Standard Specifications for Structural Supports for Highway Signs, Luminaires and Traffic Signals* (7). This specification contains the strength requirements of the poles and bracket arms for various wind loads, as well as the frangibility requirements. All luminaire supports, poles, and bracket arms must comply with these specifications.
- IES RP-8: *The American National Standard Practice for Roadway Lighting* (8). This Recommended Practice, published by the Illuminating Engineering Society, provides standards for average-maintained illuminance, luminance, and small target visibility, as well as uniformity of lighting. Recommended illumination levels for streets with various classifications and in various areas are given in Exhibit 7-23.

Exhibit 7-23. Recommended street illumination levels.

Street Classification	Area Classification	Average Maintained Illuminance Values	Illuminance Uniformity Ratio (Average to Minimum)
Arterial	Commercial	17 lx (1.7 fc)	3 to 1
	Intermediate	13 lx (1.3 fc)	
	Residential	9 lx (0.9 fc)	
Collector	Commercial	12 lx (1.2 fc)	4 to 1
	Intermediate	9 lx (0.9 fc)	
	Residential	6 lx (0.6 fc)	
Local	Commercial	9 lx (0.9 fc)	6 to 1
	Intermediate	7 lx (0.7 fc)	
	Residential	4 lx (0.4 fc)	

Definitions:

- Commercial A business area of a municipality where ordinarily there are many pedestrians during night hours. This definition applies to densely developed business areas outside, as well as within, the central part of a municipality. The area contains land use which attracts a relatively heavy volume of nighttime vehicular and/or pedestrian traffic on a frequent basis.
- Intermediate Those areas of a municipality often with moderately heavy nighttime pedestrian activity such as in blocks having libraries, community recreation centers, large apartment buildings, industrial buildings, or neighborhood retail stores.
- Residential A residential development, or a mixture of residential and small commercial establishments, with few pedestrians at night.

Note: Values in table assume typical asphalt roadway surface (pavement classification R2 or R3). Consult the IES document for other pavement surfaces.

Source: Illuminating Engineering Society RP-8 (8)

7.3.3 General recommendations

The primary goal of illumination is to ensure perception of the approach and mutual visibility among the various categories of users. To achieve this, the following features are recommended:

- The overall illumination of the roundabout should be approximately equal to the sum of the illumination levels of the intersecting roadways. If the approaching roadways have been designed to the illumination levels given in Exhibit 7-23, this may result in illumination levels at the roundabout ranging from 9 lx (0.8 fc) for roundabouts at the intersection of local streets in residential areas to 36 lx (3.4 fc) for roundabouts at the intersection of arterials in commercial areas. Local illumination standards should also be considered when establishing the illumination at the roundabout to ensure that the lighting is consistent.
- Good illumination should be provided on the approach nose of the splitter islands, at all conflict areas where traffic is entering the circulating stream, and at all places where the traffic streams separate to exit the roundabout.
- It is preferable to light the roundabout from the outside in towards the center. This improves the visibility of the central island and the visibility of circulating vehicles to vehicles approaching to the roundabout. Ground-level lighting within the central island that shines upwards towards objects in the central island can improve their visibility.

Lighting from the central island causes vehicles to be backlit and thus less visible.

- Special consideration should be given to lighting pedestrian crossing and bicycle merging areas.

7.3.4 Clear zone requirements

As discussed in Chapter 5, the proportion of single-vehicle crashes at roundabouts is high compared to other intersection types. This is because roundabouts consist of a number of relatively small-radii horizontal curves for each traveled path through the roundabout. Drivers travel on these curves with quite high values of side friction, particularly at roundabouts in higher speed areas. Single-vehicle crashes, which predominantly involve out-of-control vehicles, increase with an increased amount of side friction.

Because of the relatively high number of out-of-control vehicles, it is desirable to have adequate amounts of clear zone where there are no roadside hazards on each side of the roadway. Lighting supports and other poles should not be placed within small splitter islands or on the right-hand perimeter just downstream of an exit point. Lighting poles should be avoided in central islands when the island diameter is less than 20 m (65 ft).

The reader should refer to the AASHTO *Roadside Design Guide* for a more detailed discussion of clear zone requirements (9).

7.4 Work Zone Traffic Control

During the construction of a roundabout it is essential that the intended travel path be clearly identified. This may be accomplished through pavement markings, signing, delineation, channelizing devices, and guidance from police and/or construction personnel, depending on the size and complexity of the roundabout. Care should be taken to minimize the channelizing devices so that the motorist, bicyclist, and pedestrian has a clear indication of the required travel path. Each installation should be evaluated separately, as a definitive guideline for the installation of roundabouts is beyond the scope of this guide. Refer to Part 6 of the MUTCD for requirements regarding work zone traffic control.

7.4.1 Pavement markings

The pavement markings used in work zones should be the same layout and dimension as those used for the final installation. Because of the confusion of a work area and the change in traffic patterns, additional pavement markings may be used to clearly show the intended direction of travel. In some cases when pavement markings cannot be placed, channelizing devices should be used to establish the travel path.

7.4.2 Signing

The signing in work zones should consist of all necessary signing for the efficient movement of traffic through the work area, preconstruction signing advising the pub-

Construction signing for a roundabout should follow the MUTCD standard.

lic of the planned construction, and any regulatory and warning signs necessary for the movement of traffic outside of the immediate work area. The permanent roundabout signing should be installed where practicable during the first construction stage so that it is available when the roundabout is operable. Permanent signing that cannot be installed initially should be placed on temporary supports in the proposed location until permanent installation can be completed.

7.4.3 Lighting

Permanent lighting, as described in Section 7.3, should be used to light the work area. If lighting will not be used, pavement markings, as described in Section 7.2, should be used.

7.4.4 Construction staging

Construction staging should be considered during the siting of the roundabout, especially if it must be built under traffic.

As is the case with any construction project, before any work can begin, all traffic control devices should be installed as indicated in the traffic control plan or recommended typical details. This traffic control shall remain in place as long as it applies and then be removed when the message no longer applies to the condition.

Prior to work that would change the traffic patterns to that of a roundabout, certain peripheral items may be completed. This would include permanent signing (covered), lighting, and some pavement markings. These items, if installed prior to the construction of the central island and splitter islands, would expedite the opening of the roundabout and provide additional safety during construction.

When work has commenced on the installation of the roundabout, it is desirable that it be completed as soon as possible to minimize the time the public is faced with an unfinished layout or where the traffic priority may not be obvious. If possible, all work, including the installation of splitter islands and striping, should be done before the roundabout is open to traffic.

If it is necessary to leave a roundabout in an uncompleted state overnight, the splitter islands should be constructed before the central island. Any portion of the roundabout that is not completed should be marked, delineated, and signed in such a way as to clearly outline the intended travel path. Pavement markings that do not conform to the intended travel path should be removed.

It is highly desirable to detour traffic for construction of a roundabout. This will significantly reduce the construction time and cost and will increase the safety of the construction personnel. If it is not possible to detour all approaches, detour as many approaches as possible and stage the remainder of the construction as follows:

1. Install and cover proposed signing.
2. Construct outside widening if applicable.
3. Reconstruct approaches if applicable.

4. Construct splitter islands and delineate the central island. At this point the signs should be uncovered and the intersection should operate as a roundabout.
5. Finish construction of the central island.

7.4.5 Public education

It is important to educate the public whenever there is a change in traffic patterns. It is especially important for a roundabout because a roundabout will be new to most motorists. The techniques discussed in Chapter 2 can be applied during the construction period. The following are some specific suggestions to help alleviate initial driver confusion.

- Hold public meetings prior to construction;
- Prepare news releases/handouts detailing what the motorist can expect before, during, and after construction;
- Install variable message signs before and during construction;
- Use Travelers Advisory Radio immediately prior to and during construction to disseminate information on “How to drive,” etc.; and
- Install signing during and after construction that warns of changed traffic patterns.

7.5 Landscaping

This section provides an overview of the use of landscaping in the design of a roundabout.

7.5.1 Advantages

Landscaping in the central island, in splitter islands (where appropriate), and along the approaches can benefit both public safety and community enhancement.

The landscaping of the roundabout and approaches should:

- Make the central island more conspicuous;
- Improve the aesthetics of the area while complementing surrounding streetscapes as much as possible;
- Minimize introducing hazards to the intersection, such as trees, poles, walls, guide rail, statues, or large rocks;
- Avoid obscuring the form of the roundabout or the signing to the driver;
- Maintain adequate sight distances, as discussed in Chapter 6;
- Clearly indicate to the driver that they cannot pass straight through the intersection;
- Discourage pedestrian traffic through the central island; and
- Help blind and visually impaired pedestrians locate sidewalks and crosswalks.

Public education during construction is as important as the public education effort during the planning process.

Landscaping is one of the distinguishing features that gives roundabouts an aesthetic advantage over traditional intersections.

7.5.2 Central island landscaping

The central island landscaping can enhance the safety of the intersection by making the intersection a focal point and by lowering speeds. Plant material should be selected so that sight distance (discussed in Chapter 6) is maintained, including consideration of future maintenance requirements to ensure adequate sight distance for the life of the project. Large, fixed landscaping (trees, rocks, etc.) should be avoided in areas vulnerable to vehicle runoff. In northern areas, the salt tolerance of any plant material should be considered, as well as snow storage and removal practices. In addition, landscaping that requires watering may increase the likelihood of wet and potentially slippery pavement. Exhibit 7-24 shows the recommended placement of landscaping within the central island.

The slope of the central island should not exceed 6:1 per the requirements of the AASHTO *Roadside Design Guide* (9).

Avoid items in the central island that might tempt people to take a closer look.

Where truck aprons are used in conjunction with a streetscape project, the pavement should be consistent with other streetscape elements. However, the material used for the apron should be different than the material used for the sidewalks so that pedestrians are not encouraged to cross the circulatory roadway. Street furniture that may attract pedestrian traffic to the central island, such as benches or monuments with small text, must be avoided. If fountains or monuments are being considered for the central island, they must be designed in a way that will enable proper viewing from the perimeter of the roundabout. In addition, they must be located and designed to minimize the possibility of impact from an errant vehicle.

Exhibit 7-24. Landscaping of the central island.

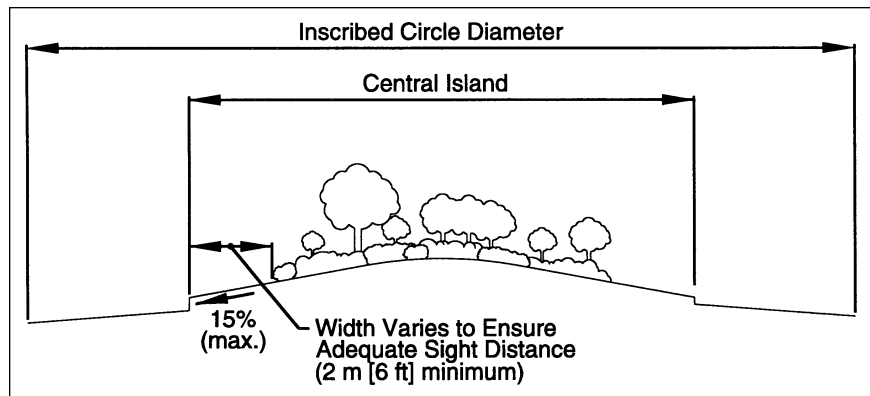

7.5.3 Splitter island and approach landscaping

In general, unless the splitter islands are very large or long, they should not contain trees, planters, or light poles. Care must be taken with the landscaping to avoid obstructing sight distance, as the splitter islands are usually located within the critical sight triangles (see Chapter 6).

Landscaping on the approaches to the roundabout can enhance safety by making the intersection a focal point and by reducing the perception of a high-speed through traffic movement. Plant material in the splitter islands (where appropriate) and on the right and left side of the approaches can help to create a funneling effect and induce a decrease in speeds approaching the roundabout. Landscaping in the corner radii will help to channelize pedestrians to the crosswalk areas and discourage pedestrians from crossing to the central island.

7.5.4 Maintenance

A realistic maintenance program should be considered in the design of the landscape features of a roundabout. It may be unrealistic to expect a typical highway agency to maintain a complex planting plan. Formal agreements may be struck with local civic groups and garden clubs for maintenance where possible. Liability issues should be considered in writing these agreements. Where there is no interest in maintaining the proposed enhancements, the landscape design should consist of simple plant materials or hardscape items that require little or no maintenance.

Ensure that whatever landscaping is installed, it will be maintained.

7.6 References

1. Federal Highway Administration (FHWA). *Manual on Uniform Traffic Control Devices*. Washington, D.C.: FHWA, 1988.
2. Federal Highway Administration (FHWA). *Standard Highway Signs*. Washington, D.C.: FHWA, 1979.
3. Smith, S.A., and R.L. Knoblauch. "Guidelines for the Installation of Crosswalk Markings." In *Transportation Research Record 1141*. Transportation Research Board, National Research Council, Washington, D.C., 1987.
4. Herms, B.F. "Some Visual Aspects of Pedestrian Crosswalks." In *Proceedings, 22nd California Street and Highway Conference*, Institute of Transportation and Traffic Engineering, University of California, Los Angeles, January 1970.
5. Centre d'Etudes sur les Réseaux les Transports, l'Urbanisme et les constructions publiques (CERTU). *L'Éclairage des Carrefours à Sens Giratoire (The Illumination of Roundabout Intersections)*. Lyon, France: CERTU, 1991.
6. American Association of State Highway and Transportation Officials (AASHTO). *An Information Guide for Roadway Lighting*. Washington, D.C.: AASHTO, 1985.
7. American Association of State Highway and Transportation Officials (AASHTO). *Standard Specifications for Structural Supports for Highway Signs, Luminaires and Traffic Signals*. Washington, D.C.: AASHTO, 1994.
8. Illuminating Engineering Society (IES). *American National Standard Practice for Roadway Lighting*. Standard RP-8. December 1982.
9. American Association of State Highway and Transportation Officials (AASHTO). *Roadside Design Guide*. Washington, D.C.: AASHTO, 1989.



System Considerations

8.1	Traffic Signals at Roundabouts	213
8.1.1	Metered entrance	214
8.1.2	Nearby vehicular and pedestrian signals	214
8.1.3	Full signalization of the circulatory roadway	215
8.2	At-Grade Rail Crossings	215
8.3	Closely Spaced Roundabouts	217
8.4	Roundabout Interchanges	219
8.4.1	Two-bridge roundabout interchange	219
8.4.2	One-bridge roundabout interchange	220
8.4.3	Analysis of roundabout interchanges	222
8.4.4	Geometric design parameters	223
8.5	Roundabouts in an Arterial Network	223
8.5.1	Platooned arrivals on roundabout approaches	224
8.5.2	Roundabout departure pattern	224
8.5.3	Wide nodes and narrow roads	225
8.6	Microscopic Simulation	227
8.6.1	How to use simulation	227
8.6.2	Examples of simulation models	228
8.7	References	229

Exhibit 8-1.	Rail crossing treatments at roundabouts.	216
Exhibit 8-2.	Methods for accommodating a rail crossing adjacent to a roundabout.	217
Exhibit 8-3.	Example of closely spaced offset T-intersections with roundabouts.	218
Exhibit 8-4.	Through bypass lanes at staggered T-intersections.	218
Exhibit 8-5.	Two-bridge roundabout interchange.	219
Exhibit 8-6.	Examples of two-bridge roundabout interchanges.	220
Exhibit 8-7.	Examples of one-bridge roundabout interchanges with circular central islands.	221
Exhibit 8-8.	One-bridge roundabout interchange with raindrop-shaped central islands.	222
Exhibit 8-9.	Roundabouts in an arterial network.	223
Exhibit 8-10.	Wide nodes and narrow roads.	226
Exhibit 8-11.	Summary of simulation models for roundabout analysis.	228

Chapter 8 System Considerations

Roundabouts have been considered as isolated intersections in most other international roundabout guides and publications. However, roundabouts may need to fit into a network of intersections, with the traffic control functions of a roundabout supporting the function of nearby intersections and vice versa. The purpose of this chapter is to provide some guidance on potentially difficult, but not uncommon, circumstances or constraints.

Many countries whose initial design and driver experience was with isolated roundabouts have since extended their application to transportation system design and operation. This chapter addresses the appropriate use of roundabouts in a roadway network context and the benefits obtained. Since the design of each roundabout should generally follow the principles of isolated roundabout design, the discussion is at a conceptual and operational level and generally complements the planning of isolated roundabouts discussed in Chapter 3. In many cases, site-specific issues will determine the appropriate roundabout design elements.

To establish some fundamental understanding for subsequent discussion, three design issues at an isolated roundabout are presented. First, this chapter will describe the requirements and effects of signal control of one or more legs of a roundabout, as well as the entire roundabout. It is noted that fully signalized roundabouts are not desirable. Next, modified designs that incorporate at-grade rail crossings are discussed. It is noted that intersections with rail lines passing through them or near them are not desirable. However, these situations do occur and would then need to be analyzed.

Building upon this understanding, the next sections address design and performance of two closely spaced roundabouts and the specific application to roundabout interchanges. This is followed by issues pertaining to the use of roundabouts on an arterial or network that may include or replace coordinated signalized intersections. Finally, the role of microscopic simulation models in assisting with analysis of these system effects is reviewed.

8.1 Traffic Signals at Roundabouts

Although yield control of entries is the default at roundabouts, when necessary, traffic circles and roundabouts have been signalized by metering one or more entries, or signalizing the circulatory roadway at each entry. Roundabouts should never be planned for metering or signalization. However, unexpected demand may dictate the need after installation. Each of these will be discussed in turn. In the first case, entrance metering can be implemented at the entrance or some distance upstream.

This chapter considers roundabouts as they relate to other elements of the transportation system, including other intersections.

Roundabouts should not be planned for metering or signalization unless unexpected demand dictates this need after installation.

8.1.1 Metered entrance

Roundabouts operate effectively only when there are sufficient longer and acceptable gaps between vehicles in the circulatory lanes. If there is a heavy movement of circulating drivers, then entering drivers at the next downstream entry may not be able to enter. This situation occurs most commonly during the peak periods, and the performance of the roundabout can be greatly improved with entrance metering.

The concept of entrance metering at roundabouts is similar to ramp metering on freeways. A convenient sign is a changeable one that reads "Stop on red signal" and shows the usual yield sign for a roundabout otherwise. The sign would also include a yellow and red signal above the sign. The operation of the sign would be to show drivers the roundabout sign, display the yellow light and the sign "Stop on red signal," and finally display the red light and the same text sign. This would cause entering vehicles to stop and allow the vehicles at the downstream entrance to proceed. A queue length detector on the downstream entrance may be used to indicate to the signal controller when the metering should be activated and deactivated. Once on the circulatory roadway, vehicles are not stopped from leaving the roundabout.

8.1.2 Nearby vehicular and pedestrian signals

Nearby intersections or pedestrian crossing signals can also meter traffic, but not as effectively as direct entrance metering.

Another method of metering is the use, with appropriate timing, of a nearby upstream signalized intersection or a signalized pedestrian crossing on the subject approach road. Unlike pure entry metering, such controls may stop vehicles from entering and leaving the roundabout, so expected queue lengths on the roundabout exits between the metering signal and the circulatory roadway should be compared with the proposed queuing space.

Because of additional objectives and constraints, metering by upstream signals is generally not as effective as direct entrance metering. However, a signalized pedestrian crossing may be desirable on its own merits. More than one entrance can be metered, and the analyst needs to identify operational states and evaluate each one separately to provide a weighted aggregate performance measure.

When disabled pedestrians and/or school children are present at a high-volume site, a pedestrian-actuated traffic signal could be placed 20 to 50 m (65 to 165 ft) from the yield line. This longer distance than at an unsignalized crossing may be required because the vehicle queues downstream of the roundabout exit will be longer. The trade-offs for any increased distance requirement are increased walking distances and higher exiting vehicle speeds. An analysis of signal timing will be needed to minimize queuing of vehicles into the roundabouts.

8.1.3 Full signalization of the circulatory roadway

Full signalization that includes control of circulating traffic at junctions with major entrances is possible at large-diameter multilane traffic circles or rotaries that have adequate storage space on the circulatory roadway. The double-lane roundabout dimensions resulting from the design criteria recommended in this guide may preclude such possibilities. As stated previously, full signalization should in any case only be considered as a retrofit alternative resulting from unanticipated traffic demands. Other feasible alternatives should also be considered, such as flaring critical approaches, along with the associated widening of the circulatory roadway; converting a large-diameter rotary to a more compact modern roundabout form; or converting to a conventional signalized intersection. This guide recommends that signalizing roundabouts to improve capacity be considered only when it is the most cost-effective solution.

Traffic signals at fully signalized rotaries should be timed carefully to prevent queuing on the circulatory roadway by ensuring adequate traffic progression of circulating traffic and especially critical movements. Introducing continuous or part-time signals on the circulatory roadway requires careful design of geometry, signs, lane markings, and signal timing settings, and literature on this specific topic should be consulted (1, 2).

Full signalization of the circulatory roadway requires careful coordination and vehicle progression.

8.2 At-Grade Rail Crossings

Locating any intersection near an at-grade railroad crossing is generally discouraged. However, roundabouts are sometimes used near railroad-highway at-grade crossings. Rail transit, including stations, have successfully been incorporated into the medians of approach roadways to a roundabout, with the tracks passing through the central island. In such situations, the roundabout either operates partially during train passage, or is completely closed to allow the guided vehicles or trains to pass through. The treatment of at-grade rail crossings should follow primarily the recommendations of the *Manual on Uniform Traffic Control Devices* (MUTCD) (3). Another relevant reference is the *FHWA Railroad-Highway Grade Crossing Handbook* (4).

There are essentially two ways in which rails can interact with a roundabout, as shown in Exhibit 8-1:

- Through the center; or
- Across one leg in close proximity to the roundabout.

In either case, traffic must not be forced to stop on the tracks. A new intersection should not be designed with railroad tracks passing through the center of it. However, on occasions, the rail line passes through an existing intersection area. The traffic engineer might be faced with a decision whether to change the intersection type to a roundabout or to grade-separate the crossing.

A gated rail crossing through the center of a roundabout can be accommodated in two ways. The first method is to prevent all vehicular traffic from entering the roundabout. The second method is to prevent traffic from crossing the tracks while still allowing some movements to occur. This latter method will have lower delays and queues, but it may be more confusing and less safe.

A gated rail crossing adjacent to a roundabout can be accommodated in two ways, as shown in Exhibit 8-2:

Closing only the leg with the rail crossing may work if queues are not anticipated to back into the circulatory roadway.

- *Method A: Closure only at rail crossing.* This method prohibits vehicles from crossing the rails but still allows vehicles to enter and leave the circulatory roadway. This method allows for many of the movements through the roundabout to continue to run free, if a queue does not build to the point of impeding circulation within the roundabout. A queuing analysis should be performed using the expected volume crossing the rails and the expected duration of rail crossing to determine the likelihood that this blockage will occur. In general, this method works better than Method B if there is sufficient separation between the roundabout and the rail crossing. If blockage is anticipated, the designer should choose Method B.
- *Method B: Closure at rail crossing and at most entries to the roundabout.* This method closes all entries to the roundabout except for the entry nearest the rail crossing. This allows any vehicles in the roundabout to clear prior to the arrival of the train. In addition, a gate needs to be provided on the approach to the rail crossing exiting the roundabout to protect against possible U-turns in the roundabout. This causes increased queuing on all approaches but is generally safer than Method A when there is insufficient storage capacity between the roundabout and rail crossing.

Exhibit 8-1. Rail crossing treatments at roundabouts.

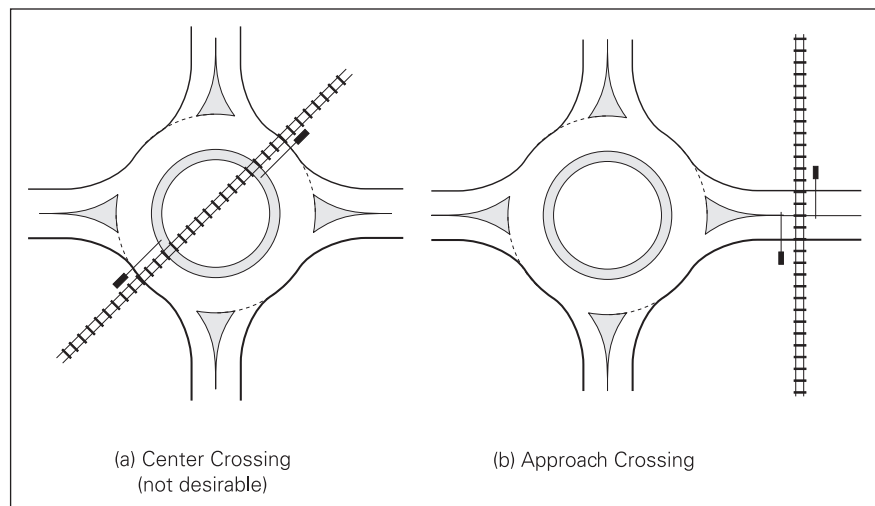
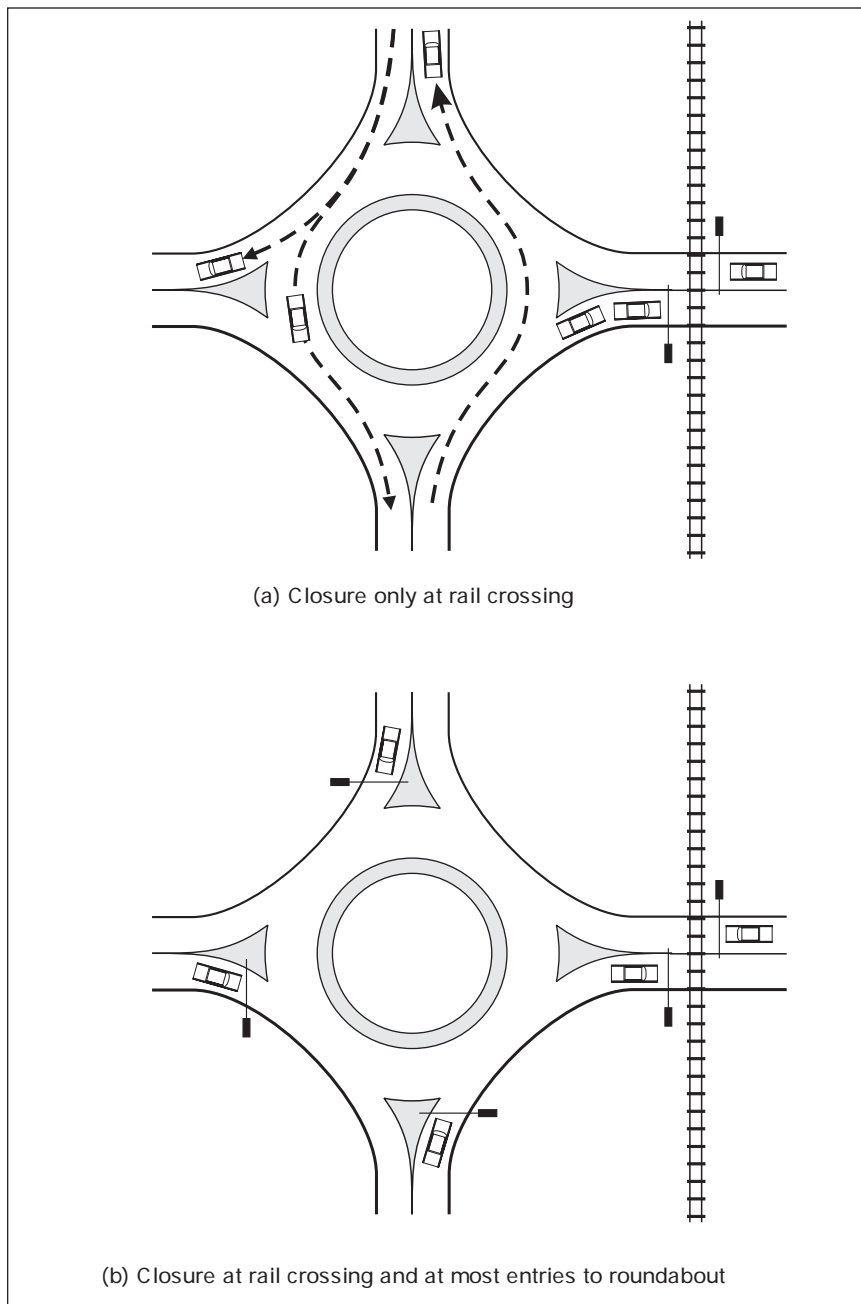

Exhibit 8-2. Methods for accommodating a rail crossing adjacent to a roundabout.



8.3 Closely Spaced Roundabouts

It is sometimes desirable to consider the operation of two or more roundabouts in close proximity to each other. In these cases, the expected queue lengths at each roundabout become important. Exhibit 8-3 presents an example of closely spaced T-intersections. The designer should compute the 95th-percentile queues for each approach to check that sufficient queuing space is provided for vehicles between the roundabouts. If there is insufficient space, then drivers will occasionally queue into the upstream roundabout and may cause it to lock.

Exhibit 8-3. Example of closely spaced offset T-intersection with roundabouts.



France (5)

Closely spaced roundabouts may have a traffic calming effect on the major road.

Closely spaced roundabouts may improve safety by “calming” the traffic on the major road. Drivers may be reluctant to accelerate to the expected speed on the arterial if they are also required to slow again for the next close roundabout. This may benefit nearby residents.

When roundabouts are used at offset T-intersections, there is an opportunity to bypass one through lane direction on the major road at each roundabout. Exhibit 8-4 presents sketches of through bypass lanes for the two basic types of offset T-intersection configurations. In both cases, through traffic in each direction needs to negotiate only one roundabout, and capacity is therefore typically improved. The weaving section should be analyzed both for capacity and for safety through an evaluation of the relative speeds of the weaving vehicles.

Exhibit 8-4. Through bypass lanes at staggered T-intersections.

Option A (roundabout precedes bypass) is preferred.

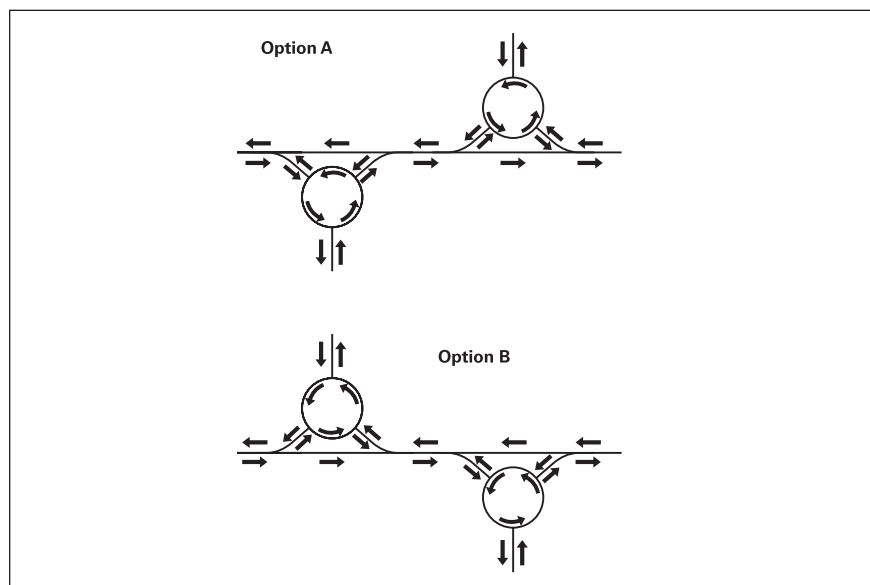

Of the two arrangements shown in Exhibit 8-4, Option A (roundabout precedes bypass) is preferred. The roundabout offers a visual cue to drivers to slow in Arrangement A and encourages slower (and therefore safer) driving through the two roundabouts. If Option B (bypass precedes roundabout) is used, the merges and diverges could occur at higher speeds. It may be appropriate in this case to omit the bypass lane and pass all through traffic through both roundabouts. Another advantage of Option A is that there would be less queuing of traffic on the road space between the roundabouts.

Note that when conventional T-intersections are used, Option A is less preferable than Option B due to the need to provide interior storage space for left turns in Option A. Therefore, roundabouts may be a satisfactory solution for cases like Option A.

8.4 Roundabout Interchanges

Freeway ramp junctions with arterial roads are potential candidates for roundabout intersection treatment. This is especially so if the subject interchange typically has a high proportion of left-turn flows from the off-ramps and to the on-ramps during certain peak periods, combined with limited queue storage space on the bridge crossing, off-ramps, or arterial approaches. In such circumstances, roundabouts operating within their capacity are particularly amenable to solving these problems when compared with other forms of intersection control.

8.4.1 Two-bridge roundabout interchange

There are two basic types of roundabout interchanges. The first is a large diameter roundabout centered over or under a freeway. The ramps connect directly into the roundabout, as do the legs from the crossroad. This is shown in Exhibit 8-5.

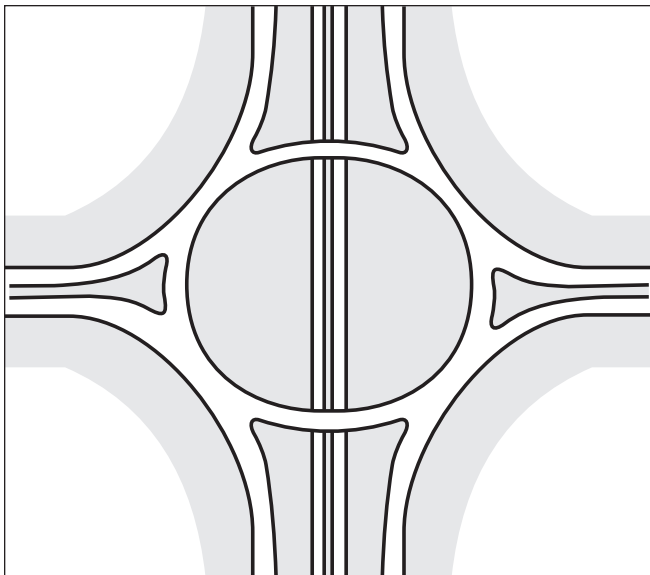

Source: Based on (6)

Exhibit 8-5. Two-bridge roundabout interchange.

The freeway may go either over or under the circulatory roadway.

This type of interchange requires two bridges. If the roundabout is above the freeway as shown in Exhibit 8-5, then the bridges may be curved. Alternatively, if the freeway goes over the roundabout then up to four bridges may be required. The number of bridges will depend on the optimum span of the type of structure compared with the inscribed diameter of the roundabout island and on whether the one bridge is used for both freeway directions or whether there is one bridge for each direction. The road cross-section will also influence the design decision. Exhibit 8-6 shows an example from the United Kingdom. The designer should decide if the expected speeds of vehicles at larger roundabouts are acceptable.

Exhibit 8-6. Examples of two-bridge roundabout interchanges.



A50/Heron Cross, United Kingdom (mirrored to show right-hand-side driving)

8.4.2 One-bridge roundabout interchange

The second basic type uses a roundabout at each side of the freeway and is a specific application of closely spaced roundabouts discussed in the previous section. A bridge is used for the crossroad over the freeway or for a freeway to cross over the minor road. Again, two bridges may be used when the freeway crosses over the minor road.

One-bridge roundabout interchanges have been successfully used to defer the need for bridge widening.

This interchange form has been used successfully in some cases to defer the need to widen bridges. Unlike signalized ramps that may require exclusive left-turn lanes across the bridge and extra queue storage, this type of roundabout interchange exhibits very little queuing between the intersections since these movements are almost unopposed. Therefore, the approach lanes across the bridge can be minimized.

The actual roundabouts can have two different shapes or configurations. The first configuration is a conventional one with circular central islands. This type of configuration is recommended when it is desirable to allow U-turns at each roundabout or to provide access to legs other than the cross street and ramps. Examples from the United Kingdom and France are shown in Exhibit 8-7.



Exhibit 8-7. Examples of one-bridge roundabout interchanges with circular central islands.



Exhibit 8-7 (continued). Examples of one-bridge roundabout interchanges with circular central islands.

France

Raindrop central islands make wrong-way movements more difficult, but require navigating two roundabouts to make a U-turn.

The second configuration uses raindrop-shaped central islands that preclude some turns at the roundabout. This configuration is best used when ramps (and not frontage roads) intersect at the roundabout. A raindrop central island can be considered to be a circular shape blocked at one end. In this configuration, a driver wanting to make a U-turn has to drive around both raindrop-shaped central islands. This configuration has an additional advantage in that it makes wrong-way turns into the off-ramps more difficult. On the other hand, drivers do not have to yield when approaching from the connecting roadway between the two roundabouts. If the roundabout is designed poorly, drivers may be traveling faster than they should to negotiate the next roundabout safely. The designer should analyze relative speeds to evaluate this alternative. On balance, if the length of the connecting road is short, this design may offer safety advantages. Exhibit 8-8 provides an example of this type of interchange configuration.

Exhibit 8-8. One-bridge roundabout interchange with raindrop-shaped central islands.



Interstate 70/Avon Road, Avon, CO

8.4.3 Analysis of roundabout interchanges

The traffic performance evaluation of the roundabout interchange is the same as for a single conventional roundabout. The maximum entry capacity is dependent on the circulatory flow and the geometry of the roundabouts. The evaluation process is included in Chapter 4.

Roundabouts produce more random headways on ramps than signalized intersections, resulting in smoother merging behavior on the freeway.

The benefits and costs associated with this type of interchange also follow those for a single roundabout. A potential benefit of roundabout interchanges is that the queue length on the off-ramps may be less than at a signalized intersection. In almost all cases, if the roundabout would operate below capacity, the performance of the on-ramp is likely to be better than if the interchange is signalized. The headway between vehicles leaving the roundabout along the on-ramp is more random than when signalized intersections are used. This more random ramp traffic allows for smoother merging behavior on the freeway and a slightly higher performance at the freeway merge area compared with platooned ramp traffic from a signalized intersection.

The traffic at any entry is the same for both configurations. The entry capacity is the same and the circulating flow is the same for the large single roundabout (Exhibit 8-6) and for the second configuration of the two teardrop roundabout system (Exhibit 8-8). Note that the raindrop form may be considered and analyzed as a single large roundabout as in the circular roundabout interchange, but with a “pinched” waistline across or under one bridge rather than two. The relative performance of these systems will only be affected by the geometry of the roundabouts and islands. The system with the two circular roundabouts will have a slightly different performance depending upon the number of U-turns.

8.4.4 Geometric design parameters

The design parameters are not restrained by any requirement here. They are only constrained by the physical space available to the designer and the configuration selected. The raindrop form can be useful if grades are a design issue since they remove a potential cross-slope constraint on the missing circulatory road segments.

If there are more roads intersecting with the interchange than the single cross road, then two independent circular roundabouts are likely to be the best solution.

8.5 Roundabouts in an Arterial Network

In order to understand how roundabouts operate within a roadway system, it is important to understand their fundamental arrival and departure characteristics and how they may interact with other intersections. Exhibit 8-9 gives an example of a series of roundabouts along an arterial street.



Avon Road, Avon, CO

Exhibit 8-9. Roundabouts in an arterial network.

The Avon Road network consists of five roundabouts (all pictured)—two at the interchange ramp terminals and three along the arterial south of the freeway.

Signalized intersections close to roundabouts produce gaps in traffic that can be used by minor street traffic to enter the major street.

8.5.1 Platooned arrivals on roundabout approaches

The performance of a roundabout is affected by its proximity to signalized intersections. If a signalized intersection is very close to the roundabout, it causes vehicles to enter the roundabout in closely spaced platoons; more importantly, it results in regular periods when no vehicles enter. These latter periods provide an excellent opportunity for traffic on the next downstream entry to enter. Since the critical gap is larger than the follow-up time, a roundabout becomes more efficient when the vehicles are handled as packets of vehicles rather than as isolated vehicles.

When the signalized intersection is some distance from the roundabout, then the vehicles' arrival patterns have fewer closely spaced platoons. Platoons tend to disperse as they move down the road. The performance of a roundabout will be reduced under these circumstances when compared with a close upstream signal. If arrival speeds are moderate, then few longer gaps allow more drivers to enter a roundabout than a larger number of shorter gaps. If arrival speeds are low, then there are more opportunities for priority-sharing (where entering and circulating vehicles alternate) and priority-reversals (where the circulating vehicles tend to yield to entering vehicles) between entering and circulating traffic streams, and the influence of platoon dispersal is not as marked.

8.5.2 Roundabout departure pattern

Traffic leaving a roundabout tends to be more random than if another type of intersection control were used. A roundabout may therefore affect the performance of other unsignalized intersections or driveways more than if the intersection was signalized. However, as this traffic travels further along the road downstream of the roundabout, the faster vehicles catch up to the slower vehicles and the proportion of platooning increases.

In the case of a well-defined platoon from an upstream signalized intersection arriving at a downstream unsignalized intersection just after a well-defined platoon arrives from the other direction, it may be difficult for the minor street drivers at this unsignalized intersection to enter the link. If, on the other hand, one of these signalized intersections were to be replaced by a roundabout, then the effect of the random traffic from the roundabout might be relatively advantageous. Under these conditions, more dispersed platoons (or random) traffic could assist drivers entering along the link at the unsignalized intersection.

Even one circulating vehicle in a roundabout will result in a platoon breaking down.

If a roundabout is used in a network of coordinated signalized intersections, then it may be difficult to maintain the closely packed platoons required. If a tightly packed platoon approached a roundabout, it could proceed through the roundabout as long as there was no circulating traffic or traffic upstream from the left. Only one circulating vehicle would result in the platoon breaking down. Hence, the use of roundabouts in a coordinated signalized network needs to be evaluated carefully. One possibility for operating roundabouts within a signal network is to signalize the major approaches of the roundabout and coordinate them with adjacent upstream and downstream signalized intersections.

Another circumstance in which a roundabout may be advantageous is as an alternative to signal control at a critical signalized intersection within a coordinated network. Such intersections are the bottlenecks and usually determine the required cycle length, or are placed at a signal system boundary to operate in isolated actuated mode to minimize their effect on the rest of the surrounding system. If a roundabout can be designed to operate within its capacity, it may allow a lowering of the system cycle length with resultant benefits to delays and queues at other intersections.

Because roundabouts accommodate U-turns more easily than do signals, they may also be useful as an access management tool. Left-turn exits from driveways onto an arterial which may currently experience long delays and require two-stage left-turn movements could be replaced with a simpler right turn, followed by a U-turn at the next roundabout.

8.5.3 Wide nodes and narrow roads

The ultimate manifestation of roundabouts in a system context is to use them in lieu of signalized intersections. Some European cities such as Nantes, France, and some Australian cities have implemented such a policy. It is generally recognized that intersections (or nodes), not road segments (or links), are typically the bottlenecks in urban roadway networks. A focus on maximizing intersection capacity rather than widening streets may therefore be appropriate. Efficient, signalized intersections, however, usually require that exclusive turn lanes be provided, with sufficient storage to avoid queue spillback into through lanes and adjacent intersections. In contrast, roundabouts may require more right-of-way at the nodes, but this may be offset by not requiring as many basic lanes on the approaches, relative to signalized arterials. This concept is demonstrated in Exhibit 8-10.

Analysis tools, such as those provided in Chapter 4, should be used to evaluate the arterial or network. These may be supplemented by appropriate use of microscopic simulation models as discussed next. Supplemental techniques to increase the capacity of critical approaches may be considered if necessary, such as bypass lanes, flaring of approaches and tapering of exits, and signalization of some roundabout approaches.

Roundabouts as an access management tool.

Roundabouts may require more right-of-way at intersections, but may also allow fewer lanes (and less right-of-way) between intersections.

Exhibit 8-10. Wide nodes and narrow roads.

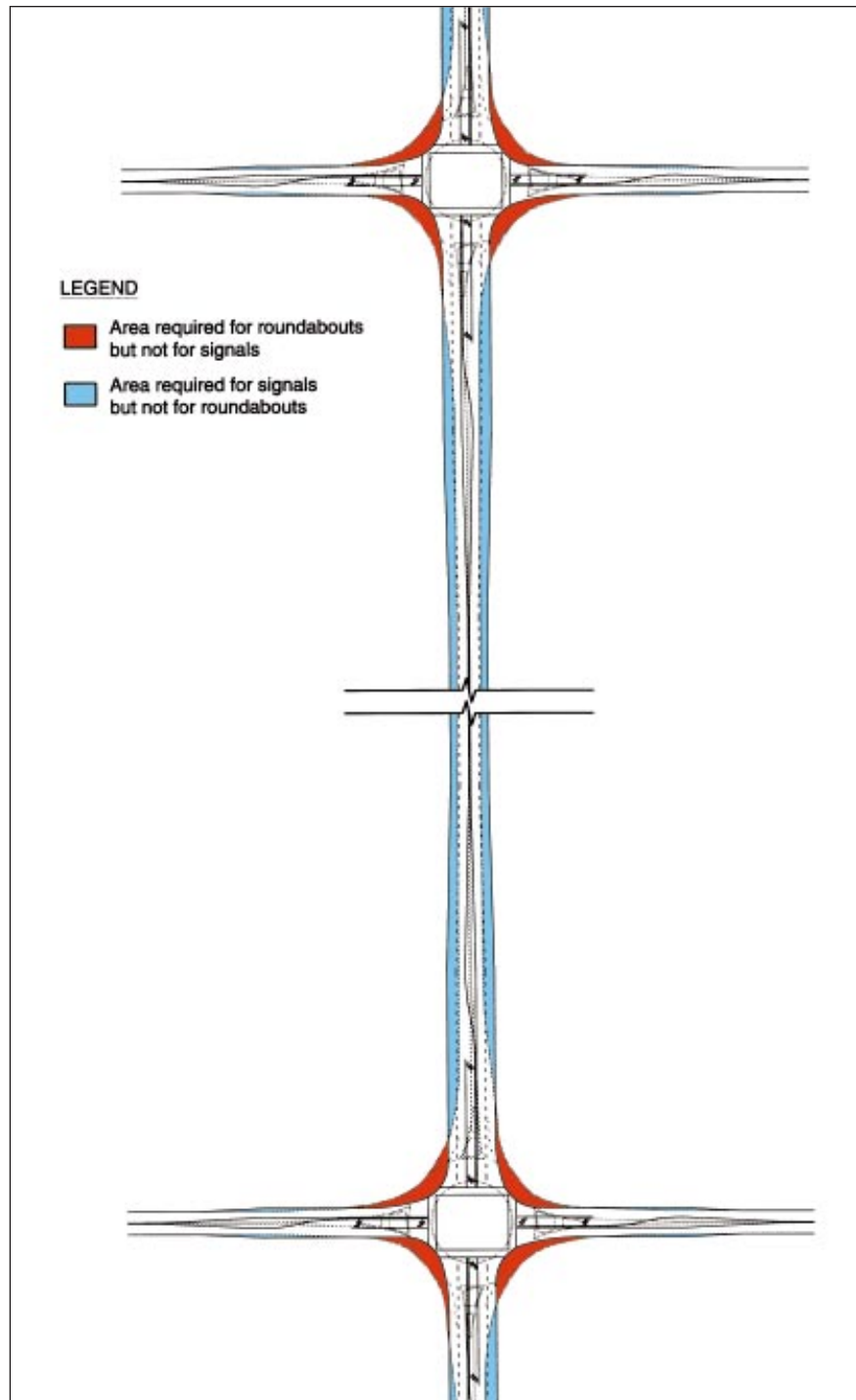

8.6 Microscopic Simulation

Microscopic simulation of traffic has become a valuable aid in assessing the system performance of traffic flows on networks, as recognized by the *Highway Capacity Manual 2000* (7). Analysis of many of the treatments discussed in this chapter may benefit from the use of appropriate simulation models used in conjunction with analytic models of isolated roundabouts discussed in Chapter 4. These effects include more realistic modeling of arrival and departure profiles, time-varying traffic patterns, measurement of delay, spatial extent and interaction of queues, fuel consumption, emissions, and noise. However, the user must carefully select the appropriate models and calibrate the model for a particular use, either against field data, or other validated analytic models. It would also be advisable to check with others to see if there have been any problems associated with the use of the model.

8.6.1 How to use simulation

Microscopic simulation models are numerous and new ones are being developed, while existing models are upgraded frequently. Each model may have particular strengths and weaknesses. Therefore, when selecting a model, analysts should consider the following:

- Should a simulation model be used, or is an isolated analytic roundabout model sufficient?
- What are the model input requirements, are they sufficient, and how can they be provided or estimated?
- What outputs does the model provide in animated, graphical, or tabular form?
- What special features of the model are pertinent to the problem being addressed?
- Does the user manual for the simulation model specifically address modeling a roundabout?
- How sensitive is the model to various geometric parameters?
- Is there literature on the validation of this model for evaluating roundabouts?
- Is there sufficient information available on the microscopic processes being used by the model such as car following, gap acceptance, lane changing, or steering? (The availability of animation can assist in exposing model logic.)
- Are relevant past project examples available?

When a simulation model is used, the analyst is advised to use the results to make relative comparisons of the differences between results from changing conditions, and not to conclude that the absolute values found from the model are equivalent to field results. It is also advisable to perform a sensitivity analysis by changing selected parameters over a range and comparing the results. If a particular parameter is found

Simulation results are best used for relative comparisons, rather than relying on absolute values produced by the model.

to affect the outcomes significantly, then more attention should be paid to accurate representation and calibration of this parameter. Finally, the analyst should check differences in results from using different random number seeds. If the differences are large, then the simulation time should be increased substantially.

8.6.2 Examples of simulation models

Five commercially available microscopic simulation models are CORSIM, Integration, Simtraffic, Paramics, and VISSIM. The first three are North American models; Paramics is from Scotland, and VISSIM is from Germany. The following sections present a brief overview of each model. Since software packages (and simulation models in particular) are in constant development, the user is encouraged to consult the most current information available on each model.

Exhibit 8-11. Summary of simulation models for roundabout analysis.

Name	Scope	Notes (1999 versions)
CORSIM	Urban streets, freeways	FHWA has been investigating modifications that may be required for CORSIM to adequately model controls such as stop and yield control at roundabouts through gap acceptance logic. In this research, roundabouts have been coded as a circle of four yield-controlled T-intersections. The effect of upstream signals on each approach and their relative offsets has also been reported (8).
Integration	Urban streets, freeways	Integration has documented gap acceptance logic for permitted movements at signal-, yield-, and stop-controlled intersections. As with CORSIM, Integration requires coding a roundabout simply as a series of short links and nodes with yield control on the entrances.
Simtraffic	Urban streets	Simtraffic is a simulation model closely tied to the signal timing software package Synchro. Simtraffic has the capability to model unsignalized intersections and thus may be suitable for modeling roundabouts. However, no publications to date have demonstrated the accuracy of Simtraffic in modeling roundabout operations.
Paramics	Urban streets, freeways	Paramics has been used in the United Kingdom and internationally for a wide range of simulation projects. It has been specifically compared with ARCADY in evaluating roundabouts (9). The model has a coding feature to automatically code a roundabout intersection at a generic node, which may then be edited. The model has been used in the United Kingdom for a number of actual roundabout evaluations. The model specifically employs a steering logic on the circulatory roadway to track a vehicle from an entry vector to a target exit vector (10).
VISSIM	Urban streets, transit networks	VISSIM is widely used in Germany for modeling urban road and transit networks, including roundabouts. Roundabout examples are provided with the software, including explicit modeling of transit and pedestrians. Modeling a roundabout requires detailed coding of link connectors, control, and gap acceptance parameters (11).

8.7 References

1. Brown, M. *TRL State of the Art Review—The Design of Roundabouts*. London: HMSO, 1995.
2. Hallworth, M.S. "Signalling Roundabouts." In *Traffic Engineering + Control*, Vol. 33, No. 6, June 1992.
3. Federal Highway Administration (FHWA). *Manual on Uniform Traffic Control Devices*. Washington, D.C.: FHWA, 1988.
4. Federal Highway Administration. *Railroad-Highway Grade Crossing Handbook*, 2nd edition. Report number FHWA-TS-86-215, September 1986.
5. Centre D'Etudes sur les Réseaux, les Transports, l'Urbanisme, et les Constructions Publiques (CERTU) (Center for Studies on Transportation Networks, Urban Planning, and Public Works). *Carrefours Urbains (Urban Intersections) Guide*. Lyon, France: CERTU, January 1999.
6. Department of Transport (United Kingdom). *Geometric Design of Roundabouts*. TD 16/93. September 1993.
7. Transportation Research Board. *Highway Capacity Manual*. Special Report 209. Washington, D.C.: Transportation Research Board, National Research Council, July 1999 (draft).
8. Courage, K.G. "Roundabout Modeling in CORSIM." Presented at the Third International Symposium on Intersections without Traffic Signals, Portland, Oregon, U.S.A., 1997.
9. Paramics, Ltd. "Comparison of Arcady and Paramics for Roundabout Flows." Version 0.3. August 23, 1996.
10. Duncan, G. "Paramics Technical Report: Car-Following, Lane-Changing and Junction Modelling." Edinburgh, Scotland: Quadstone, Ltd., 1997.
11. Innovative Transportation Concepts, LLC. *VISSIM—User Manual*. Program Version 2.32–2.36. November 10, 1997.

Glossary

85th-percentile speed—a speed value obtained from a set of field-measured speeds where only 15 percent of the observed speeds are greater (source: HCM 2000).

AADT—see *average annual daily traffic*.

AASHO—American Association of State Highway Officials. Predecessor to *AASHTO*.

AASHTO—American Association of State Highway and Transportation Officials.

accessible—describes a site, building, facility, or portion thereof that complies with the Americans with Disabilities Act Accessibility Guidelines (source: ADAAG).

accessible route—a continuous, unobstructed path connecting all accessible elements and spaces of a building or facility. Exterior accessible routes may include parking access aisles, curb ramps, crosswalks at vehicular ways, walks, ramps, and lifts (source: ADAAG).

accident—see *crash*.

ADA—Americans with Disabilities Act.

ADAAG—Americans with Disabilities Act Accessibility Guidelines.

all-way stop control—all approaches at the intersections have stop signs where all drivers must come to a complete stop. The decision to proceed is based in part on the rules of the road, which suggest that the driver on the right has the right-of-way, and also on the traffic conditions of the other approaches (source: HCM 2000).

angle, entry—see *entry angle*.

approach—the portion of a roadway leading into a *roundabout*.

approach capacity—the capacity provided at the *yield line* during a specified period of time.

approach curvature—a series of progressively sharper curves used on an *approach* to slow traffic to a safe speed prior to reaching the *yield line*.

approach road half-width—term used in the United Kingdom regression models. The approach half width is measured at a point in the approach upstream from any *entry flare*, from the median line or median curb to the nearside curb along a line perpendicular to the curb. See also *approach width*. (source: UK Geometric Design of Roundabouts)

approach speed—the posted or 85th-percentile speed on an *approach* prior to any geometric or signing treatments designed to slow speeds.

approach width—the width of the roadway used by approaching traffic upstream of any changes in width associated with the roundabout. The *approach* width is typically no more than half the total roadway width.

apron—the mountable portion of the *central island* adjacent to the *circulatory roadway*. Used in smaller roundabouts to accommodate the wheel tracking of large vehicles.

average annual daily traffic—the total volume passing a point or segment of a highway facility in both directions for one year divided by the number of days in the year (source: HCM 2000).

average effective flare length—term used in the United Kingdom regression models. Defined by a geometric construct and is approximately equivalent to the length of flare that can be effectively used by vehicles. (source: UK Geometric Design of Roundabouts)

AWSC—see *all-way stop control*.

back of queue—the distance between the yield line of a roundabout and the farthest reach of an upstream queue, expressed as a number of vehicles. The vehicles previously stopped at the front of the queue may be moving (adapted from HCM 2000).

A

B

benefit-cost analysis—a method of economic evaluation that uses the *benefit-cost ratio* as the measure of effectiveness.

benefit-cost ratio—the difference in benefits between an alternative and the no-build scenario, divided by the difference in costs between the alternative and the no-build scenario. See also *incremental benefit-cost ratio*.

bulb-out—see *curb extension*.

C capacity—the maximum sustainable flow rate at which persons or vehicles can be reasonably expected to traverse a point or uniform segment of a lane or roadway during a specified time period under a given roadway, geometric, traffic, environmental, and control conditions. Usually expressed as vehicles per hour, passenger cars per hour, or persons per hour (source: HCM 2000).

capacity, approach—see *approach capacity*.

capacity, roundabout—see *roundabout capacity*.

capital recovery factor—a factor that converts a present value cost into an annualized cost over a period of n years using an assumed discount rate of i percent.

central island—the raised area in the center of a *roundabout* around which traffic circulates.

CFR—Code of Federal Regulations.

channelization—the separation or regulation of conflicting traffic movements into definite paths of travel by traffic islands or pavement marking to facilitate the safe and orderly movements of both vehicles and pedestrians (source: 1994 AASHTO Green Book).

circle, inscribed—see *inscribed circle*.

circular intersection—an intersection that vehicles traverse by circulating around a *central island*.

circulating flow—see *circulating volume*.

circulating path radius—the minimum radius on the fastest through path around the *central island*.

circulating traffic—vehicles located on the *circulatory roadway*.

circulating volume—the total volume in a given period of time on the *circulatory roadway* immediately prior to an entrance.

circulatory roadway—the curved path used by vehicles to travel in a counterclockwise fashion around the *central island*.

circulatory roadway width—the width between the outer edge of the *circulatory roadway* and the central island, not including the width of any *apron*.

circulating speed—the speed vehicles travel at while on the *circulatory roadway*.

community enhancement roundabout—a *roundabout* used for aesthetic or community enhancement reasons, rather than as a solution to traffic problems. When used, often located in commercial and civic districts.

conflict point—a location where the paths of two vehicles, or a vehicle and a bicycle or pedestrian, merge, diverge, cross, or queue behind each other.

conflict, crossing—see *crossing conflict*.

conflict, diverge—see *diverge conflict*.

conflict, merge—see *merge conflict*.

conflict, queuing—see *queuing conflict*.

conflicting flows—the two paths that merge, diverge, cross, or queue behind each other at a *conflict point*.

control delay—delay experienced by vehicles at an intersection due to movements at slower speeds and stops on approaches as vehicles move up in the queue.

crash—a collision between a vehicle and another vehicle, a pedestrian, a bicycle, or a fixed object.

crash frequency—the average number of crashes at a location per period of time.

crash rate—the number of crashes at a location or on a roadway segment, divided by the number of vehicles entering the location or by the length of the segment.

CRF—see *capital recovery factor*.

crossing conflict—the intersection of two traffic streams, including pedestrians. Crossing conflicts are the most severe type of conflict.

curb extension—the construction of curbing such that the width of a street is reduced. Often used to provide space for parking or a bus stop or to reduce pedestrian crossing distances.

curb ramp—a short ramp cutting through a curb or built up to it (source: ADAAG).

curvature, approach—see *approach curvature*.

D factor—the proportion of the two-way traffic assigned to the peak direction.

D

deflection—the change in trajectory of a vehicle imposed by geometric features of the roadway.

degree of saturation—see *volume-to-capacity ratio*.

delay—additional travel time experienced by a driver, passenger, or pedestrian beyond what would reasonably be desired for a given trip.

delay, control—see *control delay*.

delay, geometric—see *geometric delay*.

demand flow—the number of vehicles or persons that would like to use a roadway facility during a specified period of time.

departure width—the width of the roadway used by departing traffic downstream of any changes in width associated with the *roundabout*. The departure width is typically no more than half the total roadway width.

design user—any user (motorized or nonmotorized) that can be reasonably be anticipated to use a facility.

design vehicle—the largest vehicle that can reasonably be anticipated to use a facility.

detectable warning surface—a standardized surface feature built in or applied to walking surfaces or other elements to warn visually impaired people of hazards on a circulation path (source: ADAAG).

diameter, inscribed circle—see *inscribed circle diameter*.

distance, set-back—see *set-back distance*.

diverge conflict—the separation of two traffic streams, typically the least severe of all conflicts.

double-lane roundabout—a *roundabout* that has at least one entry with two lanes, and a *circulatory roadway* that can accommodate more than one vehicle traveling side-by-side.

downstream—the direction toward which traffic is flowing (source: HCM 2000).

entering traffic—vehicles located on a *roundabout* entrance.

E

entering volume—the total volume in a given period of time on an entrance to a roundabout.

entry angle—term used in the United Kingdom regression models. It serves as a geometric proxy for the conflict angle between entering and circulating streams and is determined through a geometric construct. (source: UK Geometric Design of Roundabouts)

entry flare—the widening of an approach to multiple lanes to provide additional capacity at the *yield line* and storage.

entry flow—see *entering volume*.

entry path curvature—term used in the United Kingdom to describe a measure of the amount of entry *deflection* to the right imposed on vehicles at the entry to a roundabout. (source: UK Geometric Design of Roundabouts)

entry path radius—the minimum radius on the fastest through path prior to the yield line.

entry radius—the minimum radius of curvature of the outside curb at the entry.

entry speed—the speed a vehicle is traveling at as it crosses the *yield line*.

entry width—the width of the entry where it meets the *inscribed circle*, measured perpendicularly from the right edge of the entry to the intersection point of the left edge line and the inscribed circle.

entry, perpendicular—see *perpendicular entry*.

exit path radius—the minimum radius on the fastest through path into the exit.

exit radius—the minimum radius of curvature of the outside curb at the exit.

exit width—the width of the exit where it meets the *inscribed circle*, measured perpendicularly from the right edge of the exit to the intersection point of the left edge line and the *inscribed circle*.

exiting traffic—vehicles departing a *roundabout* by a particular exit.

extended splitter island—see *splitter island, extended*.

F **FHWA**—Federal Highway Administration.

flare—see *entry flare*.

flare, entry—see *entry flare*.

flow, circulating—see *circulating volume*.

flow, demand—see *demand flow*.

flow, entry—see *entry volume*.

flows, conflicting—see *conflicting flows*.

G **geometric delay**—the delay caused by the alignment of the lane or the path taken by the vehicle on a roadway or through an intersection.

geometric design—a term used in this document to describe the design of horizontal and vertical alignment and cross-sectional elements of a roadway.

give way—term used in the United Kingdom and Australia for *yield*.

“give way” rule—rule adopted in the United Kingdom in November 1966 which required that all vehicles entering a roundabout *give way*, or *yield*, to circulating vehicles.

H **HCM**—Highway Capacity Manual.

I **IES**—Illuminating Engineers Society.

incremental benefit-cost ratio—the difference in benefits between two alternatives, divided by the difference in costs between the two alternatives. See also *benefit-cost ratio*.

inscribed circle—the circle forming the outer edge of the *circulatory roadway*.

inscribed circle diameter—the basic parameter used to define the size of a *roundabout*, measured between the outer edges of the *circulatory roadway*. It is the diameter of the largest circle that can be inscribed within the outline of the *intersection*.

interchange—a grade-separated junction of two roadways, where movement from one roadway to the other is provided for.

intersection—an at-grade junction of two or more roadways.

intersection sight distance—the distance required for a driver without the right-of-way to perceive and react to the presence of conflicting vehicles.

island, central—see *central island*.

island, median—see *splitter island*.

island, separator—see *splitter island*.

island, splitter—see *splitter island*.

ITE—Institute of Transportation Engineers.

K factor—the proportion of the AADT assigned to the design hour.

K

left-turn path radius—the minimum radius on the fastest path of the conflicting left-turn movement.

L

level of service—a qualitative measure describing operational conditions within a traffic stream, generally described in terms of service measures such as speed and travel time, freedom to maneuver, traffic interruptions, comfort, and convenience.

line, yield—see *yield line*.

locking—stoppage of traffic on the *circulatory roadway* caused by queuing backing into the *roundabout* from one of the exits, resulting in traffic being unable to enter or circulate.

LOS—see *level of service*.

maximum service volume—the maximum hourly rate at which vehicles, bicycles, or persons can be reasonably expected to traverse a point or uniform section of a roadway during an hour under specific assumed conditions while maintaining a designated level of service. (source: HCM 2000)

M

measures of effectiveness—a quantitative parameter whose value is an indicator of the performance of a transportation facility or service from the perspective of the users of the facility or service.

median island—see *splitter island*.

merge conflict—the joining of two traffic streams.

mini-roundabout—small roundabouts used in low-speed urban environments. The *central island* is fully *mountable*, and the *splitter islands* are either painted or *mountable*.

model, crash prediction—see *crash prediction model*.

modern roundabout—a term used to distinguish newer *circular intersections* conforming to the characteristics of *roundabouts* from older-style *rotaries* and *traffic circles*.

m.o.e.—see *measures of effectiveness*.

mountable—used to describe geometric features that can be driven upon by vehicles without damage, but not intended to be in the normal path of traffic.

multilane roundabout—a *roundabout* that has at least one entry with two or more lanes, and a *circulatory roadway* that can accommodate more than one vehicle traveling side-by-side.

MUTCD—Manual on Uniform Traffic Control Devices.

neighborhood traffic circle—a *circular intersection* constructed at the intersection of two local streets for *traffic calming* and/or aesthetic purposes. They are generally not channelized, may be uncontrolled or stop-controlled, and may allow left turns to occur left (clockwise) of the *central island*.

N

nonconforming traffic circle—see *traffic circle*.

nontraversable—see *raised*.

O **O&M costs**—operations and maintenance costs.

P **peak hour factor**—the hourly volume during the maximum-volume hour of the day divided by the peak 15-minute flow rate within the peak hour; a measure of traffic demand fluctuation within the peak hour.

pedestrian refuge—an at-grade opening within a median island that allows pedestrians to safely wait for an acceptable gap in traffic.

perpendicular entry—an *entry angle* of 70 degrees or more.

PHF—see *peak hour factor*.

platoon—a group of vehicles or pedestrians traveling together as a group, either voluntarily or involuntarily because of signal control, geometrics, or other factors.

point, conflict—see *conflict point*.

priority—the assignment of *right-of-way* to a particular traffic stream or movement.

progression, signal—see *signal progression*.

Q **queue**—a line of vehicles, bicycles, or persons waiting to be served by the system in which the flow rate from the front of the queue determines the average speed within the queue. Slowly moving vehicles or persons joining the rear of the queue are usually considered a part of the queue. The internal queue dynamics may involve a series of starts and stops. (source: HCM 2000)

queuing conflict—a conflict that arises within a traffic stream between a lead vehicle and a following vehicle, when the lead vehicle must come to a stop.

R **radius, circulating path**—see *circulating path radius*.

radius, entry—see *entry radius*.

radius, entry path—see *entry path radius*.

radius, exit—see *exit radius*.

radius, exit path—see *exit path radius*.

radius, left-turn path—see *left-turn path radius*.

radius, right-turn path—see *right-turn path radius*.

raised—used to describe geometric features with a sharp elevation change that are not intended to be driven upon by vehicles at any time.

ramp, wheelchair—see *wheelchair ramp*.

refuge, pedestrian—see *pedestrian refuge*.

right-of-way—(1) an intersection user that has *priority* over other users. (2) Land owned by a public agency for transportation uses.

right-turn bypass lane—a lane provided adjacent to, but separated from, the *circulatory roadway*, that allows right-turning movements to bypass the *roundabout*. Also known as a *right-turn slip lane*.

right-turn path radius—the minimum radius on the fastest path of a right-turning vehicle.

right-turn slip lane—see *right-turn bypass lane*.

roadway, circulatory—see *circulatory roadway*.

rotary—a term used particularly in the Eastern U.S. to describe an older-style *circular intersection* that does not have one or more of the characteristics of a *roundabout*. They often have large diameters, often in excess of 100 m (300 ft), allowing high travel speeds on the *circulatory roadway*. Also known as a *traffic circle*.

roundabout—a *circular intersection* with yield control of all entering traffic, channelized approaches, counter-clockwise circulation, and appropriate geometric curvature to ensure that travel speeds on the *circulatory roadway* are typically less than 50 km/h (30 mph).

roundabout capacity—the maximum number of entering vehicles that can be reasonably expected to be served by a *roundabout* during a specified period of time.

roundabout, community enhancement—see *community enhancement roundabout*.

roundabout, modern—see *modern roundabout*.

roundabout, multilane—see *multilane roundabout*.

roundabout, rural double-lane—see *rural double-lane roundabout*.

roundabout, rural single-lane—see *rural single-lane roundabout*.

roundabout, single lane—see *single-lane roundabout*.

roundabout, urban compact—see *urban compact roundabout*.

roundabout, urban single-lane—see *urban single-lane roundabout*.

rural double-lane roundabout—a *roundabout* located in a rural area that has at least one entry with two lanes, and a *circulatory roadway* that can accommodate more than one vehicle traveling side-by-side. They incorporate *approach curvature* to slow *entering traffic* to a safe speed.

rural single-lane roundabout—a *roundabout* located in a rural area that has single lanes on all entries and one *circulatory lane*. This form typically has larger diameters and more tangential exits than urban forms.

separator island—see *median island*.

service volume—the hourly rate at which vehicles, bicycles, or persons can be reasonably expected to traverse a point or uniform section of a roadway during an hour under specific assumed conditions. See also *maximum service volume*. (Adapted from HCM 2000)

set-back distance—the distance between the edge of the *circulatory roadway* and the sidewalk.

sharpness of flare—a measure of the rate at which extra width is developed in the *entry flare*. (source: UK Geometric Design of Roundabouts)

sight distance, intersection—see *intersection sight distance*.

sight distance, stopping—see *stopping sight distance*.

sight triangle—an area required to be free of obstructions to enable visibility between conflicting movements.

signal progression—the use of coordinated traffic signals along a roadway in order to minimize stops and delay to through traffic on the major road.

single-lane roundabout—a *roundabout* that has single lanes on all entries and one *circulatory lane*.

speed table—an extended, flat-top road hump sometimes used at pedestrian crossings to slow traffic and to provide a better visual indication of the crosswalk location.

speed, approach—see *approach speed*.

speed, circulating—see *circulating speed*.

speed, entry—see *entry speed*.

S

splitter island—a raised or painted area on an approach used to separate entering from exiting traffic, deflect and slow entering traffic, and provide storage space for pedestrians crossing that intersection approach in two stages. Also known as a *median island* or a *separator island*.

splitter island, extended—a raised splitter island that begins some distance upstream of the pedestrian crossing to separate entering and exiting traffic. A design feature of rural roundabouts.

stopping sight distance—the distance along a roadway required for a driver to perceive and react to an object in the roadway and to brake to a complete stop before reaching that object.

T **traffic calming**—geometric treatments used to slow traffic speeds or to discourage the use of a roadway by nonlocal traffic.

traffic circle—a *circular intersection* that does not have one or more of the characteristics of a *roundabout*. Also known as a *rotary*.

traffic circle, neighborhood—see *neighborhood traffic circle*.

traffic circle, nonconforming—see *traffic circle*.

traffic design—a term used in this document to describe the design of traffic control devices, including signing, pavement markings, and construction traffic control.

traffic, circulating—see *circulating traffic*.

traffic, entering—see *entering traffic*.

truck apron—see *apron*.

two-stage crossing—a process in which pedestrians cross a roadway by crossing one direction of traffic at a time, waiting in a *pedestrian refuge* between the two traffic streams if necessary before completing the crossing.

two-way stop-control—stop signs are present on the approach(es) of the minor street. Drivers on the minor street or drivers turning left from the major street wait for a gap in the major street traffic in order to complete a maneuver.

TWSC—see *two-way stop control*.

U **U-turn**—a turning movement at an *intersection* in which a vehicle departs the intersection using the same roadway it used to enter the intersection.

upstream—the direction from which traffic is flowing (source: HCM 2000).

urban compact roundabout—a small *roundabout* with a raised *central island* and *splitter islands*, with perpendicular approaches that require vehicles to make a distinct right turn into the *circulatory roadway*.

urban double-lane roundabout—an urban *roundabout* with at least one entry with two lanes, and a *circulatory roadway* that can accommodate more than one vehicle traveling side-by-side. They have similar speed characteristics as *urban single-lane roundabouts*.

urban single-lane roundabout—a *roundabout* with single lane entries on all legs and one circulatory lane. Entries are less perpendicular than the *urban compact roundabout*, allowing somewhat higher speeds with higher capacities.

UVC—Uniform Vehicle Code.

V **vehicle, design**—see *design vehicle*.

volume, circulating—see *circulating volume*.

volume, entering—see *entering volume*.

volume, service—see *service volume*.

volume-to-capacity ratio—the ratio of flow rate to capacity for a transportation facility.

wheelchair ramp—see *curb ramp*.

width, approach—see *approach width*.

width, circulatory roadway—see *circulatory roadway width*.

width, departure—see *departure width*.

width, entry—see *entry width*.

width, exit—see *exit width*.

W

yield—an intersection control in which controlled traffic must stop only if higher *priority* traffic is present.

yield line—a pavement marking used to mark the point of entry from an approach into the *circulatory roadway* and generally marked along the *inscribed circle*. If necessary, *entering traffic* must yield to *circulating traffic* before crossing this line into the circulatory roadway.

Y

zebra crossing—a crossing marked by transverse white stripes where vehicles are required to yield to pedestrians.

Z

Bibliography

5.1 U.S. References

American Association of State Highway Officials (AASHO). *A Policy on Design of Urban Highways and Arterial Streets*. Washington, D.C.: AASHO, 1973.

American Association of State Highway and Transportation Officials (AASHTO). *Guide for Development of Bicycle Facilities*. Washington, D.C.: AASHTO, 1991.

—. *An Information Guide for Roadway Lighting*. Washington, D.C.: AASHTO, 1985.

—. *A Manual on User Benefit Analysis of Highway and Bus Transit Improvements*. Washington, D.C.: AASHTO, 1977.

—. *A Policy on Geometric Design of Highways and Streets*. Washington, D.C.: AASHTO, 1994.

—. *Roadside Design Guide*. Washington, D.C.: AASHTO, 1989.

—. *Standard Specifications for Structural Supports for Highway Signs, Luminaires and Traffic Signals*. Washington, D.C.: AASHTO, 1994.

Americans with Disabilities Act Accessibility Guidelines for Buildings and Facilities (ADAAG). 36 CFR Part 1191. As amended through January 1998.

Federal Highway Administration (FHWA). *Manual on Uniform Traffic Control Devices*. Washington, D.C.: FHWA, 1988.

—. *Older Driver Highway Design Handbook*. Publication No. FHWA-RD-97-135. Washington, D.C.: FHWA, January 1998.

—. *Standard Highway Signs*. Washington, D.C.: FHWA, 1979.

—. *Railroad-Highway Grade Crossing Handbook*, 2nd edition. Report number FHWA-TS-86-215, September 1986.

Illuminating Engineering Society (IES). *American National Standard Practice for Roadway Lighting*. Standard RP-8. December 1982.

Institute of Transportation Engineers. *Manual of Transportation Engineering Studies* (H.D. Robertson, J.E. Hummer, and D.C. Nelson, ed.). Englewood Cliffs, N.J.: Prentice-Hall, 1994.

—. *Transportation Planning Handbook* (J. Edwards, Jr., ed.). Englewood Cliffs, New Jersey: Prentice Hall, 1992.

National Committee on Uniform Traffic Laws and Ordinances (NCUTLO). *Uniform Vehicle Code and Model Traffic Ordinance*. Evanston, Illinois: NCUTLO, 1992.

Pein, W.E. *Trail Intersection Design Guidelines*. Prepared for State Bicycle/Pedestrian Program, State Safety Office, Florida Department of Transportation. Highway Safety Research Center, University of North Carolina. September 1996.

Transportation Research Board. *Highway Capacity Manual*. Special Report 209. Washington, D.C.: Transportation Research Board, National Research Council, 1994.

—. *Highway Capacity Manual*. Special Report 209. Washington, D.C.: Transportation Research Board, National Research Council, July 1999 (draft).

5.2 Roundabout Design Guides

5.2.1 United States

Florida Department of Transportation. *Florida Roundabout Guide*. Florida Department of Transportation, March 1996

Maryland Department of Transportation. *Roundabout Design Guidelines*. State of Maryland Department of Transportation, State Highway Administration, 1995.

Ourston & Doctors, Inc. *Roundabout Design Guidelines*. 1995.

5.2.2 Australia/New Zealand

Australia/New Zealand Standard. Road lighting. Part 1.3: Vehicular traffic (Category V) lighting—Guide to design, installation, operation and maintenance. Report no. AS/NZS 1158.1.3:1997. Published jointly by Homebush, New South Wales (Australia): Standards Australia and Wellington (New Zealand): Standards New Zealand. 1997.

Austrroads. *Guide to Traffic Engineering Practice, Part 6—Roundabouts*. Sydney, Australia: Austrroads, 1993.

Queensland Department of Main Roads (QDMR). *Road Planning and Design Guidelines (Draft)*, Chapter 12, Section 12.4—Roundabouts. Brisbane, Australia: QDMR, 1999.

Queensland Department of Main Roads (QDMR). *Relationships between Roundabout Geometry and Accident Rates*. Queensland, Australia: Infrastructure Design of the Technology Division of QDMR, April 1998.

Roads and Traffic Authority (RTA), New South Wales (Australia). *Roundabouts—Geometric Design Method*. January 1997.

Roundabouts: A Design Guide, National Association of Australian State Road Authorities, 1986.

5.2.3 Germany

Small Roundabouts: Recommendations for Application and Design, Nordrhein-Westfalen Department of City Development and Traffic (MSV), prepared by Werner Brilon, Ruhr-University Bochum; translated from German by Daniel J. Parrish, 1993.

Haller, et al. *Merkblatt für die Anlage von kleinen Kreisverkehrsplätzen (Guideline for the Construction of Small Roundabouts)*. Cologne, Germany: Forschungsgesellschaft für Straßen- und Verkehrswesen. V., August 1998.

Department of Transport of Northrhine-Westfalia, Germany. *Empfehlungen zum Einsatz und zur Gestaltung von Mini-Kreisverkehrsplaetzen (Guidelines for the Use and Design of Mini-Roundabouts)*. Dusseldorf, Germany, 1999.

5.2.4 The Netherlands

C.R.O.W. *Eenheid in rotondes (Uniformity in roundabouts)*. Publication 126. Ede, The Netherlands: C.R.O.W., March 1998.

Centrum voor Regelgeving en Onderzoek in de Grond-, Water- en Wegenbouw en de Verkeerstechniek (C.R.O.W). *Rotondes (Roundabouts)*. Ede, The Netherlands: C.R.O.W. December 1993.

5.2.5 United Kingdom

Department of Transport (United Kingdom). *Geometric Design of Roundabouts*. TD 16/93. September 1993.

Sawers, C. *Mini-roundabouts: Getting them right!*. Canterbury, Kent, United Kingdom: Euro-Marketing Communications, 1996

5.2.6 France

Service d'Etudes Techniques des Routes et Autoroutes (SETRA—Center for Technical Studies of Roads and Highways). *Aménagement des Carrefours Interurbains sur les Routes Principales (Design of Rural Intersections on Major Roads)*. Ministry of Transport and Housing, December 1998.

Centre d'Études sur les Réseaux, les Transports, l'Urbanisme et les constructions publiques (CERTU). *L'Éclairage des Carrefours à Sens Giratoire (The Illumination of Roundabout Intersections)*. Lyon, France: CERTU, 1991.

Centre d'Études sur les Réseaux, les Transports, l'Urbanisme, et les Constructions Publiques (CERTU) (Center for Studies on Transportation Networks, Urban Planning, and Public Works). *Carrefours Urbains (Urban Intersections) Guide*. Lyon, France: CERTU, January 1999.

5.2.7 Spain

Ministerio de Fomento. *Recomendaciones sobre glorietas (Recommendations on roundabouts)*. Ministerio de Fomento, Dirección General de Carreteras, 1996.

5.3 Books and Reports

5.3.1 United States

Bauer, K.M., and D.W. Harwood. *Statistical Models of At-Grade Intersection Crashes*. Report No FHWA-RD-99-094. Washington, D.C.: Federal Highway Administration, 1999.

Fambro, D.B., et al. *NCHRP Report 400: Determination of Stopping Sight Distances*. National Cooperative Highway Research Program, Transportation Research Board, National Research Council. Washington, D.C.: National Academy Press, 1997.

Garder, P. *The Modern Roundabouts: The Sensible Alternative for Maine*. Maine Department of Transportation, Bureau of Planning, Research and Community Services, Transportation Research Division, 1998.

Glauz, W.D., and D.J. Migletz. *NCHRP Report 219: Application of Traffic Conflict Analysis at Intersections*. National Cooperative Highway Research Program, Transportation Research Board, National Research Council. Washington, D.C.: National Academy Press, 1980.

Harwood, D.W., et al. *NCHRP Report 383: Intersection Sight Distances*. National Cooperative Highway Research Program, Transportation Research Board, National Research Council. Washington, D.C.: National Academy Press, 1996.

Institute of Transportation Engineers. *Use of Roundabouts*, prepared by ITE Technical Council Committee 5B-17, February 1992.

Jacquemart, G. *Synthesis of Highway Practice 264: Modern Roundabout Practice in the United States*. National Cooperative Highway Research Program. Washington, D.C.: National Academy Press, 1998.

Krammes, R., et al. *Horizontal Alignment Design Consistency for Rural Two-Lane Highways*. Publication No. FHWA-RD-94-034. Washington, D.C.: Federal Highway Administration, January 1995.

Migletz, D.J., W.D. Glauz, and K.M. Bauer. *Relationships between Traffic Conflicts and Crashes*. Report No. FHWA-RD-84-042. Washington, D.C.: Federal Highway Administration, 1985.

National Safety Council. *Accident Facts*, 1998 Edition.

Ourston & Doctors, Inc. *Designs of Modern American Roundabouts*. September 1996.

Prince George's County, Maryland. *Neighborhood Traffic Management Program*. Prince George's County (Maryland), Department of Public Works and Transportation, November 1995.

The Design and Evaluation of Roundabout Layouts, source unknown

Transportation Research Board. *Review of International Practices Used to Evaluate Unsignalized Intersections*. Transportation Research Circular 468. Washington, D.C.: Transportation Research Board, National Research Council, April 1997.

5.3.2 United Kingdom

Brown, M. *TRL State of the Art Review—The Design of Roundabouts*. London: HMSO, 1995.

Department of Transport (United Kingdom). *The Highway Code*. Department of Transport and the Central Office of Information for Her Majesty's Stationery Office, 1996.

Kimber, R.M., and E.M. Hollis. *Traffic queues and delays at road junctions*. TRRL Laboratory Report LR 909. Crowthorne, England: Transport and Road Research Laboratory, 1979.

Kimber, R.M. *The traffic capacity of roundabouts*. TRRL Laboratory Report LR 942. Crowthorne, England: Transport and Road Research Laboratory, 1980.

Maycock, G., and R.D. Hall. *Crashes at four-arm roundabouts*. TRRL Laboratory Report LR 1120. Crowthorne, England: Transport and Road Research Laboratory, 1984.

5.3.3 Australia

Australia. *Traffic Act*, Part 6A, 1962.

Troutbeck, R.J. *Evaluating the Performance of a Roundabout*. SR 45. Australian Road Research Board, August 1989.

VicRoads. *Victorian Traffic Handbook*, Fourth Edition. Melbourne, Australia: Roads Corporation, 1998.

5.3.4 Germany

Brilon, W., B. Stuwe, and O. Drews. *Sicherheit und Leistungsfähigkeit von Kreisverkehrsplätzen (Safety and Capacity of Roundabouts)*. Research Report. Ruhr-University Bochum, 1993.

Empfehlungen zum Einsatz und zur Gestaltung kleiner Kreisverkehrsplätze, Freistaat Sachsen Einsatz-Und Gestaltung von Kreisverkehrsplätzen an Bundesstrassen Ausserhalb Bebauter Gebiete, Brilon, W. and Bondzio, L., Ruhr-Universität Bochum (Juni 1995).

5.3.5 France

Acts du Seminaire: "Giratoires 92" SETRA, CETUR.

5.3.6 The Netherlands

Schoon, C.C., and J. van Minnen. *Accidents on Roundabouts: II. Second study into the road hazard presented by roundabouts, particularly with regard to cyclists and moped riders*. R-93-16. The Netherlands: SWOV Institute for Road Safety Research, 1993.

5.4 Articles

Akçelik, R., and R.J. Troutbeck, "Implementation of the Australian roundabout analysis method in SIDRA," In *Highway Capacity and Level of Service: Proceedings of the International Symposium on Highway Capacity* (U. Brannolte, ed.), Karlsruhe, Germany. Rotterdam, Germany: Balkema Publisher, 1991, pp. 17–34.

Akçelik, R., and M. Besley, *SIDRA 5 User Guide*. Melbourne, Australia: Australian Road Research Board Transport Research Ltd., January 1999.

Akçelik, R., "Lane-by-Lane Modeling of Unequal Lane Use and Flares at Roundabouts and Signalized Intersection: the Sidra Solution," *Traffic Engineering & Control*, Vol. 38, No. 7/8, July/August 1997.

Akçelik, R., E. Chung, and M. Besley, "Performance of Roundabouts under Heavy Demand Conditions," *Road & Transport Research*, Vol. 5, No. 2, June 1996, pp. 36–50.

Akçelik, R., E. Chung, and M. Besley, "Getting Around Better," *Pc-Trans*, winter quarter 1997, pp. 14–19.

Alphand, F., U. Noelle, and B. Guichet, "Evolution of Design Rules for Urban Roundabouts in France," In *Intersection without Traffic Signals II*, Springer-Verlag, Germany (W. Brilon, ed.), 1991, pp. 126–140.

Alphand, F., U. Noelle, and B. Guichet, "Roundabouts and Road Safety: State of the Art in France," In *Intersections without Traffic Signals II*, Springer-Verlag, Germany (W. Brilon, ed.), 1991, pp. 107–125.

Arem, Bart van, "Capacities and Delays at Roundabouts in The Netherlands," *Proceedings of Seminar H held at the PTRC Transport, Highways and Planning Summer Annual Meeting*, University of Manchester Institute of Science and Technology, England, from 14–18 September 1992, pp. 257–267.

Armitage, D.J., and M. McDonald, "Roundabout Capacity," *Traffic Engineering & Control*, October 1974.

Arndt, O., "Road Design Incorporating Three Fundamental Safety Parameters," Technology Transfer Forums 5 & 6, Transport Technology Division, Main Roads Department, Queensland, Australia, August 1998.

Avent, A.M., and R.A. Taylor, "Roundabouts—Aspects of their Design and Operations," Queensland Division Technical Papers, Vol. 20, No. 17, 1979, pp. 1–10.

Bared, J.G., W. Prosser, and C. Tan Esse, "State-of-the-Art Design of Roundabouts," In *Transportation Research Record 1579*. Washington, D.C.: Transportation Research Board, National Research Council, 1997.

Bergh, T., "Intersections Without Traffic Signals—Swedish Experience on Capacity and Traffic Safety," *Intersection without Traffic Signals II*, Springer-Verlag (Werner Brilon, ed.), 1991, pp. 192–213.

Brilon, W., N. Wu, and L. Bondzio, "Unsignalized Intersections in Germany—A State of the Art 1997," In *Proceedings of the Third International Symposium on Intersections without Traffic Signals* (M. Kyte, ed.), Portland, Oregon, U.S.A. University of Idaho, 1997.

Brilon, W., and B. Stuwe, "Capacity and Design of Traffic Circles in Germany," In *Transportation Research Record 1398*. Washington, D.C.: Transportation Research Board, National Research Council, 1993.

Brilon, W., and L. Bondzio, *Untersuchung von Mini-Kreisverkehrsplaetzen (Investigation of Mini-Roundabouts)*. Ruhr-University Bochum, Germany, 1999.

Brilon, W., and L. Bondzio, White Paper: "Summary of International Statistics on Roundabout Safety" (unpublished), July 1998.

Brilon, W., and M. Vandehey, "Roundabouts—The State of the Art in Germany," In *ITE Journal*, November 1998.

Brilon, Werner, "Traffic Engineering and the New German Highway Capacity Manual," *Transportation Research A*, Vol. 28 A, No. 6, 1994, pp.469–481.

Brilon, Werner, and Birgit Stuwe, "Capacity and Safety of Roundabouts in West Germany," *Proceedings*, 15th ARRB Conference, Vol. 15, Part 5, 1990, pp. 275–281.

Brilon, Werner, Michael Grossmann, and Birgit Stuwe, "Toward a New German Guideline for Capacity of Unsignalized Intersections," *Transportation Research Record 1320*, 1991, pp.168–174.

Brude, U., and J. Larsson, *The Safety of Cyclists at Roundabouts—A Comparison Between Swedish, Danish and Dutch Results*. Swedish National Road and Transport Research Institute (VTI), Nordic Road & Transport Research No. 1, 1997.

Cassidy, Michael J., Samer M. Madanat, Wang Mu-han, and Fan Yan, "Unsignalized Intersection Capacity and Level of Service: Revisiting Critical Gap," *Transportation Research Record 1484* (1995) pp. 16–23.

Cedersund, H.A., "Traffic Safety at Roundabouts," *Intersection without Traffic Signals I*, Springer-Verlag (Werner Brilon, ed.), 1991, pp. 305–318.

Centre d'Etude des Transports Urbains (CETUR), "Safety of Roundabouts in Urban and Suburban Areas," Paris, 1992.

Chang, Stanley H., "Overcoming Unbalanced Flow Problems at a Roundabouts by Use of Part-Time Metering Signals," Master's Thesis, Monash University, January 1994.

Chin, H.C., "SIMRO: A Model to Simulate Traffic at Roundabouts," *Traffic Engineering & Controls*.

Chung, Edward, "Comparison of Roundabout Capacity and Delay Estimates from Analytical and Simulation Models," *Proceedings*, 16th ARRB Conference, Vol. 16, Part 5, 1992.

Courage, Kenneth G., "Roundabout Modeling in CORSIM," presented at the Third International Symposium on Intersections without Traffic Signals, Portland, Oregon, U.S.A., 1997.

CROW. *Sign Up for the Bike: Design Manual for a Cycle-Friendly Infrastructure*. The Netherlands: Center for Research and Standardization in Civil Engineering (CROW), 1993.

Crown, B., *An Introduction to Some Basic Principles of U.K. Roundabout Design*, presented at the ITE District 6 Conference on Roundabouts, Loveland, Colorado, October 1998.

Department of Transport (United Kingdom), "Killing Speed and Saving Lives," as reported in *Oregon Bicycle and Pedestrian Plan*, Oregon Department of Transportation, 1995.

Department of Transport, "Determination of Size of Roundabouts at Major/Minor Junctions," Departmental Advice Note TA 23/81, 1981.

Dinwoodie, J., "Surveying Traffic Delays at a Roundabout near Plymouth," *Mathematics In Transport Planning and Control* (J.D. Griffiths, ed.), 1992, pp. 227–286.

Duncan, G., "Paramics Technical Report: Car-Following, Lane-Changing and Junction Modelling." Edinburgh, Scotland: Quadstone, Ltd., 1997.

Fisk, C.S., "Traffic Performance Analysis at Roundabouts," Transportation Research Board, Vol. 25B, Bi. 2/3, 1991, pp. 89–102.

Flannery, A., and T.K. Datta, "Modern Roundabouts and Traffic Crash Experience in the United States." In *Transportation Research Record 1553*. Washington, D.C.: Transportation Research Board, National Research Council, 1996.

Flannery, A., L. Elefteriadou, P. Koza, and J. McFadden, "Safety, delay and capacity of single-lane roundabouts in the United States." In *Transportation Research Record 1646*. Washington, D.C.: Transportation Research Board, National Research Council, 1998, pp. 63–70.

Flannery, Aimee, and Tapan K. Datta, "Operational Performance Measures of American Roundabouts," Transportation Research Board Annual Meeting, January 1997, Washington D.C., January 1997.

Flannery, Aimee, and Tapan K. Datta, "Operational Performance Measures of American Roundabouts," 1996 *ITE Compendium of Technical Papers*, 1996.

Gambard, J.M., "Safety and Design of Unsignalized Intersections in France," *Intersection without Traffic Signals I*, Springer-Verlag (Werner Brilon, ed.), 1991, pp.48–61.

Guichet, B., "Roundabouts In France: Development, Safety, Design, and Capacity." In *Proceedings of the Third International Symposium on Intersections Without Traffic Signals* (M. Kyte, ed.), Portland, Oregon, U.S.A. University of Idaho, 1997.

Hagring, Ola, "The Use of the Cowan M3 Distribution for Modeling Roundabout Flow," *Traffic Engineering & Control*, May 1996, pp. 328–332.

Hakkert, A.S., D. Mahalel, and S.A. Asante, "A Comparative Study of Roundabout Capacity Procedures," *Intersection without Traffic Signals I*, Springer-Verlag (Werner Brilon, ed.), 1991, pp. 93–106.

Hallworth, M.S., "Signalling Roundabouts," In *Traffic Engineering + Control*, Vol. 33, No. 6, June 1992.

Harders, J., *Grenz- und Folgezeitlücken als Grundlage für die Berechnung der Leistungsfähigkeit von Landstrassen (Critical gaps and follow-up times for capacity calculations at rural roads)*, Schriftenreihe Strassenbau und Strassenverkehrstechnik, Vol. 216, 1976.

Heidemann, D., "Queue lengths and waiting-time distributions at priority intersections." In *Transportation Research B*, Vol. 25B, 4, pp. 163–174, 1991.

Hermes, B.F., "Some Visual Aspects of Pedestrian Crosswalks." In *Proceedings, 22nd California Street and Highway Conference*, Institute of Transportation and Traffic Engineering, University of California, Los Angeles, January 1970.

Hoglund, Paul G., "Case Study. Performance Effects of Changing a Traffic Signal Intersection to Roundabout," *Intersection without Traffic Signals I*, Springer-Verlag (Werner Brilon, ed.), 1991, pp. 141–158.

Horman, C.B., "Design and Analysis of Roundabouts," *Proceedings, 7th ARRB Conference*, Vol. 7, Part 4, 1974, pp. 58–82.

Hughes, B.P., "So You Think You Understand Gap Acceptance!," Australian Road Research Board, 19(3), 1989, pp. 195–204.

Innovative Transportation Concepts, LLC, *VISSIM—User Manual*. Program Version 2.32–2.36. November 10, 1997.

ITE Technical Council Committee 5B-17, "Use of Roundabouts," *ITE Journal*, February 1992, pp. 42–45.

Jessen, G.D., *Ein Richtlinienvorschlag für die Behandlung der Leistungsfähigkeit von Knotenpunkten ohne Signalregelung (A guideline suggested for capacity calculations for unsignalized intersections)*. Strassenverkehrstechnik, Nr. 7/8, 1968.

Jones, S.E., "Signalling Roundabouts 2. Controlling the Revolution," *Traffic Engineering & Control*, Vol. 33, No. 11, November 1992, pp. 606–613.

Kimber, R.M., "Gap-Acceptance and Empiricism in Capacity Prediction," *Transportation Science*, Vol. 23, No. 2, 1989.

Kimber, R.M., "The Design of Unsignalized Intersections in the UK," *Intersections Without Traffic Signals I*, Springer-Verlag (Werner Brilon, ed.), 1991, pp. 20–34.

Lalani, N., "The impact on accidents of the introduction of mini, small and large roundabouts at major/minor priority junctions." *Traffic Engineering + Control*, December 1975.

Lamm, R., and E. M. Choueiri, "Recommendations for Evaluating Horizontal Design Consistency Based on Investigations in the State of New York." In *Transportation Research Record 1122*. Washington, D.C.: Transportation Research Board, National Research Council, 1987.

Layfield, R.E., and G. Maycock, "Pedal-Cyclists at Roundabouts," *Traffic Engineering + Control*, June 1986, pp. 343–349.

List, George, Siew Leong, Yursi Embong, Azizan Naim, and Jennifer Conley, "Case Study Investigation of Traffic Circle Capacity," *Transportation Research Record 1457*, 1994, pp.118–126.

Little, J.D.C., *A Proof of the Queueing Formula $L = W \cdot \lambda$* . *Operations Research 9*, S. 383–387, 1961.

McDonald, M.; and D.J. Armitage, "The capacity of roundabouts," *Traffic Engineering & Control*, Vol. 19, October 1978, pp. 447–450.

Minnen, J. van, "Roundabouts," Institute for Road Safety Research SWOV, The Netherlands, 1986.

Myers, Edward J., "Modern Roundabouts for Maryland," *ITE Journal*, October 1994, pp. 18–22.

Niederhauser, M.E., B.A. Collins, E.J. Myers, "The Use of Roundabouts: Comparison with Alternate Design Solution," *Compendium of Technical Papers*, 67th Annual Meeting, Institute of Transportation Engineers, August 1997.

Ourston, Leif, "British Interchanges, Intersections, and Traffic Control Devices," *Westernite*, Vol. XXXV, No. 5, September–October 1992.

Ourston, Leif, "Wide Nodes and Narrow Roads," paper presented to the Transportation Research Board 72nd Annual Meeting, January 10–14, 1993.

Ourston, Leif, and Joe G. Bared, "Roundabouts: A Direct Way to Safer Highways," *Public Roads*, Autumn 1995, pp. 41–49.

Ourston, Leif, and Gregory A. Hall, "Modern Roundabout Interchanges come to America," *1996 ITE Compendium of Technical Papers*, 1996.

Paramics, Ltd., "Comparison of Arcady and Paramics for Roundabout Flows," Version 0.3, August 23, 1996.

Pearce, C.E.M., "A Probabilistic Model for the Behavior of Traffic at Roundabout," Transportation Research Board, Vol. 21B, No. 3, 1987, pp. 207–216. Washington, D.C., January 1997.

Rahman, Mountasser A., "Design Criteria for Roundabouts," *1995 ITE Compendium of Technical Papers*, 1995.

Redington, T., "The Modern Roundabout Arrives in Vermont," *AASJTP Quarterly Magazine*, Vol. 75, No. 1, 1995, pp. 11–12.

Schoon, C., and J. van Minnen, "The Safety of Roundabouts in The Netherlands," *Traffic Engineering & Control*, Vol. 35, No. 3, 1994, pp. 142–148.

Seim, K., "Use, Design and Safety of Small Roundabouts in Norway," In *Intersections Without Traffic Signals II*, Springer-Verlag, Germany (W. Brilon, ed.), 1991, pp. 270–281.

Service d'Etudes Techniques des Routes et Autoroutes (SETRA), *Carrefours Giratoires: Evolution des Caracteristiques Geometriques*, Ministère de l'Équipement, du Logement, de l'Aménagement du Territoire et des Transports, Documentation Technique 44, SETRA, August 1997, and 60, SETRA, May 1988.

SETRA/CETE de l'Ouest, "Safety Concerns on Roundabouts," 1998.

Simon, Michael J., "Roundabouts in Switzerland," *Intersection without Traffic Signals II*, Springer-Verlag (Werner Brilon, ed.), 1991, pp. 41–52.

Smith, Mark J., "Improved Signing for Traffic Circles," New Jersey Department of Transportation, FHWA/NJ-91-003 91-003-7350, 1990.

Smith, S.A., and R. L. Knoblauch, "Guidelines for the Installation of Crosswalk Markings." In *Transportation Research Record 1141*, Transportation Research Board, National Research Council, Washington, D.C., 1987.

Stuwe, Birgit, "Capacity and Safety of Roundabouts—German Results," *Intersection Without Traffic Signals II*, Springer-Verlag (Werner Brilon, ed.), 1991, pp. 1–12.

Tan, Jian-an, "A Microscopic Simulation Model of Roundabout Entry Operations," *Intersection without Traffic Signals I*, Springer-Verlag (Werner Brilon, ed.), 1991, pp. 159–176.

Taylor, Marie C., "UK Techniques for the Prediction of Capacities, Queues, and Delays At Intersections Without Traffic Signals," *Intersection without Traffic Signals I*, Springer-Verlag (Werner Brilon, ed.), 1991, pp. 274–288.

Technical Research Centre of Finland (VTT), "Traffic effects of a roundabout," *Nordic Road & Transport Research*, No. 1, 1993, pp. 9–11.

Todd, K., "A history of roundabouts in Britain," *Transportation Quarterly*, Vol. 45, No. 1, January 1991.

Troutbeck, R.J., "Changes to Analysis and Design of Roundabouts Initiated in the Austroads Guide" *Proceedings*, 16th ARRB Conference, Vol. 16, Part 5, 1992.

Troutbeck, R.J., "Capacity and Delays at Roundabouts—A Literature Review," Australian Road Research Board, 14(4), 1984, pp. 205–216.

Troutbeck, R.J., "Capacity and Design of Traffic Circles in Australia," *Transportation Research Record 1398*, 1993, pp. 68–74.

Troutbeck, R.J., "Current and Future Australian Practices for the Design of Unsignalized Intersections," *Intersection without Traffic Signals I*, Springer-Verlag (Werner Brilon, ed.), 1991, pp. 1–19.

Troutbeck, R.J., "Does Gap Acceptance Theory Adequately Predict the Capacity of a Roundabout," *Proceedings*, 12th ARRB Conference, Vol. 12, Part 4, 1985, pp. 62–75.

Troutbeck, R.J., "Effect of Heavy Vehicles at Australian Traffic Circles and Unsignalized Intersections," *Transportation Research Record 1398*, 1993, pp. 54–60.

Troutbeck, R.J., "Recent Australian Unsignalized Intersection Research and Practices," *Intersection without Traffic Signals II*, Springer-Verlag (Werner Brilon, ed.), 1991, pp. 238–257.

Troutbeck, R.J., "Traffic Interactions at Roundabouts," *Proceedings*, 15th ARRB Conference, Vol. 15, Part 5, 1990.

Tudge, R.T., "Accidents at Roundabouts in New South Wales," *Proceedings*, 15th ARRB Conference, Vol. 15, Part 5, 1990.

Unknown source, "Roundabouts—Implications of U.S. Implementation."

Van Minnen, J., "Safety of Bicyclists on Roundabouts Deserves Special Attention," SWOV Institute of Road Safety Research in the Netherlands, Research Activities 5, March 1996.

Vogt, A., *Crash Models for Rural Intersections: 4-Lane by 2-Lane Stop-Controlled and 2-Lane by 2-Lane Signalized*. Washington, D.C.: Federal Highway Administration, 1999.

Wallwork, Michael J., "Roundabouts," Genesis Group, Inc.

Wong, S.C., "On the Reserve Capacities of Priority Junctions and Roundabouts," Transportation Research Board, Vol. 30, No. 6, 1996, pp. 441–453.

Worthington, J.C., "Roundabout Design: A Comparison of Practice in the UK and France," *Proceedings of Seminar H Held at the PTRC Transport, Highways and Planning Summer Annual Meeting*, University of Manchester Institute of Science And Technology, England, 14–18 September 1992, pp. 269–279.

Wu, N., "An Approximation for the Distribution of Queue Lengths at Unsignalized Intersections," In *Proceedings of the Second International Symposium on Highway Capacity* (R. Akçelik, ed.). Sydney, Australia: Australian Road Research Board, 1994.

5.5 Video Cassettes

Ourston & Doctors, Inc. "I-70/Vail Road!"

—. "Nonconforming Traffic Circle Becomes Modern Roundabout."

—. "Snow at Roundabouts."

Maryland DOT. "Modern Roundabouts."

Appendix A Operational Analysis Formulas

This appendix presents the assumptions used to develop the graphs and charts in the operational analysis presented in Chapter 4.

A.1 Single-Lane Roundabout

A.1.1 Equations

$$Q_e = k(F - f_c Q_c), \quad f_c Q_c \leq F \quad (\text{A-1})$$
$$= 0, \quad f_c Q_c > F$$

where: Q_e = entry capacity, pce/h
 Q_c = circulating flow, pce/h

$$k = 1 - 0.00347(\phi - 30) - 0.978\left(\frac{1}{r} - 0.05\right) \quad (\text{A-2})$$

$$F = 303x_2 \quad (\text{A-3})$$

$$f_c = 0.210t_D(1 + 0.2x_2) \quad (\text{A-4})$$

$$t_D = 1 + \frac{0.5}{1 + \exp\left(\frac{D - 60}{10}\right)} \quad (\text{A-5})$$

$$x_2 = v + \frac{e - v}{1 + 2S} \quad (\text{A-6})$$

$$S = \frac{1.6(e - v)}{l'} \quad (\text{A-7})$$

where: e = entry width, m
 v = approach half width, m
 l' = effective flare length, m
 S = sharpness of flare, m/m
 D = inscribed circle diameter, m
 ϕ = entry angle, degrees
 r = entry radius, m

For design purposes, when $e = v$ then I' is effectively zero. However, setting $I' = 0$ results in S being undefined. Therefore a non-zero value of I' has been selected. When $e = v$, any non-zero value of I' results in $S = 0$ and $x_2 = v$.

A.1.2 Parameter assumptions

$D = 40$ m
 $r_e = 20$ m
 $\phi = 30$ degrees
 $v = 4$ m
 $e = 4$ m
 $I' = 40$ m

$$S = \frac{1.6(e-v)}{I'} = \frac{1.6(4-4)}{40} = 0$$

$$t_D = 1 + \frac{0.5}{1 + \exp\left(\frac{D-60}{10}\right)} = 1.4404$$

$$x_2 = v + \frac{e-v}{1+2S} = 4 + \frac{4-4}{1+2(0)} = 4$$

$$F = 303x_2 = 303(4) = 1212$$

$$f_c = 0.210t_D(1+0.2x_2) = 0.5447$$

$$k = 1 - 0.00347(\phi - 30) - 0.978\left(\frac{1}{r} - 0.05\right) = 1$$

A.1.3 Final equation

$$Q_e = 1212 - 0.5447Q_c \tag{A-8}$$

A.2 Double-Lane Roundabout

A.2.1 Equations

See Section A.1.1.

A.2.2 Parameter assumptions

For design purposes, when $e = v$ then I' is effectively zero. However, setting $I' = 0$ results in S being undefined. Therefore a non-zero value of I' has been selected. When $e = v$, any non-zero value of I' results in $S = 0$ and $x_2 = v$.

$D = 55$ m
 $r_e = 20$ m
 $\phi = 30$ degrees
 $v = 8$ m
 $e = 8$ m
 $I' = 40$ m

$$S = \frac{1.6(e-v)}{I'} = \frac{1.6(8-8)}{40} = 0$$

$$t_D = 1 + \frac{0.5}{1 + \exp\left(\frac{D-60}{10}\right)} = 1.3112$$

$$x_2 = v + \frac{e-v}{1+2S} = 8 + \frac{8-8}{1+2(0)} = 8$$

$$F = 303x_2 = 303(8) = 2424$$

$$f_c = 0.210t_D(1+0.2x_2) = 0.7159$$

$$k = 1 - 0.00347(\phi - 30) - 0.978\left(\frac{1}{r} - 0.05\right) = 1$$

A.2.3 Final equation

$$Q_e = 2424 - 0.7159Q_c \quad (\text{A-9})$$

A.3 Urban Compact Roundabout

The capacity curve for the urban compact roundabout is based on the capacity curves developed for roundabouts in Germany with single-lane entries and a single-lane circulatory roadway. This equation, developed by Brilon, Wu, and Bondzio is as follows:

$$Q_e = 1218 - 0.74Q_c \quad (\text{A-10})$$

where: Q_e = entry capacity, pce/h
 Q_c = circulating flow, pce/h

A.4 Short Lanes

The effect of short lanes (flare) on capacity has been documented by Wu (3). Page 321 of Wu's paper states that for a right flared approach,

$$k_{f, right} = \frac{1}{n_{F, right+1} \sqrt{(x_L + x_T)^{n_{F, right+1}} + x_R^{n_{F, right+1}}}} \quad (A-11)$$

Dropping some subscripts,

$$k = \frac{1}{n+1 \sqrt{(x_{LT})^{n+1} + (x_R)^{n+1}}} \quad (A-12)$$

Noting that the capacities of each lane are the same and that the flows are the same (that is, the entries are constantly fed with vehicles), this gives:

$$k = \frac{1}{x^{n+1} \sqrt{2}} \quad (A-13)$$

with $x_{LT} = x_R$. Capacity q_{max} is then

$$q_{max} = k \quad q_i \quad (A-14)$$

where q_i is flow in lane i and $q_1 = q_2$

$$q_{max} = \frac{2q}{x^{n+1} \sqrt{2}} \quad (A-15)$$

q_{max2} is the capacity of a two-lane roundabout, the capacity of each entry lane is $q_{max2}/2$ and this is equal to the flow, q , divided by the degree of saturation, x .

$$q_{max} = \frac{q_{max2}}{x^{n+1} \sqrt{2}} \quad (A-16)$$

The results of Equation A-16 can be compared with the results from the British equations. The TRL equations are listed above. The results are listed for four circulating flow conditions: 500 veh/h, 1000 veh/h, 1500 veh/h, and 2000 veh/h.

n	Q _c = 500 veh/h		Q _c = 1000 veh/h		Q _c = 1500 veh/h		Q _c = 2000 veh/h	
	TRL	Wu	TRL	Wu	TRL	Wu	TRL	Wu
0	940	940	668	668	395	395	123	123
1	1447	1461	1151	1208	855	955	559	702
2	1636	1640	1321	1356	1006	1072	691	787
3	1737	1737	1411	1436	1086	1135	761	834
4	1799	1799	1468	1487	1136	1175	805	864
5	1841	1841	1506	1522	1170	1203	835	884
6	1872	1871	1534	1547	1195	1223	857	899
7	1896	1895	1555	1566	1214	1238	873	910
8	1914	1913	1571	1581	1229	1250	886	919
9	1929	1928	1585	1594	1240	1260	896	926
10	1941	1940	1596	1604	1250	1268	905	932
11	1951	1950	1605	1612	1258	1274	912	936
12	1960	1959	1612	1619	1265	1280	918	941
13	1967	1966	1619	1626	1271	1285	923	944
14	1974	1973	1625	1631	1276	1289	928	947
15	1979	1978	1630	1636	1281	1293	931	950
16	1984	1983	1635	1640	1285	1296	935	952
17	1989	1988	1639	1644	1288	1299	938	955
18	1993	1992	1642	1647	1292	1302	941	957
19	1996	1996	1645	1650	1294	1304	943	958
20	2000	1999	1648	1653	1297	1306	946	960
	2066	2066	1708	1708	1350	1350	992	992

Exhibit A-1. Tabular comparison of TRL and Wu short-lane methodologies.

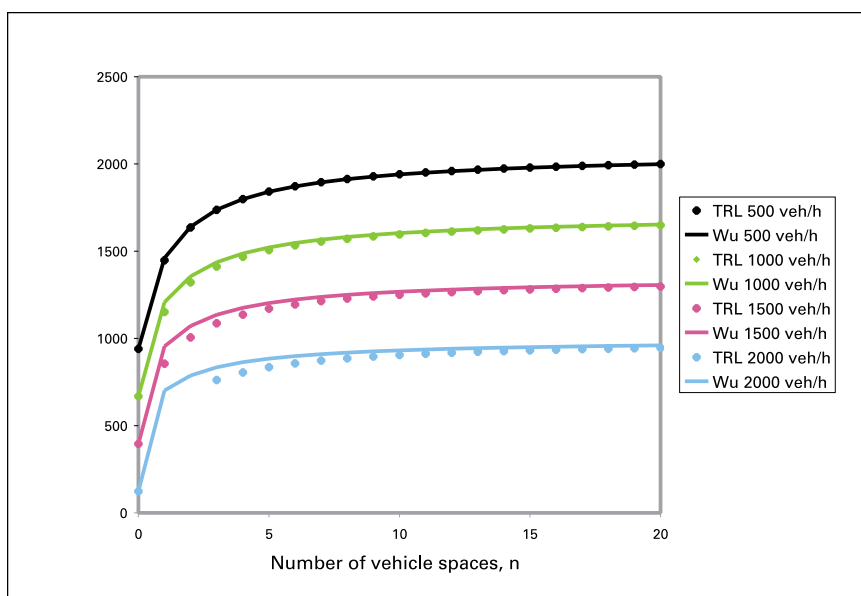

Exhibit A-2. Graphical comparison of TRL and Wu short-lane methodologies.

A.5 References

1. Kimber, R.M. *The traffic capacity of roundabouts*. TRRL Laboratory Report LR 942. Crowthorne, England: Transport and Road Research Laboratory, 1980.
2. Brilon, W., N. Wu, and L. Bondzio. "Unsignalized Intersections in Germany – A State of the Art 1997." In *Proceedings of the Third International Symposium on Intersections without Traffic Signals* (ed: M. Kyte), Portland, Oregon, U.S.A. University of Idaho, 1997.
3. Wu, N. "Capacity of shared/short lanes at unsignalized intersections." In *Proceedings of the Third International Symposium on Intersections without Traffic Signals* (ed: M. Kyte), Portland, Oregon, U.S.A. University of Idaho, 1997.

Appendix B Example Roundabout Designs

The purpose of this Appendix is to provide examples for each of the six roundabout categories. Exhibit B-1 lists typical inscribed circle diameter ranges for each roundabout category. Note that the flared-entry roundabout uses the same range of inscribed circle diameters as the double-lane roundabouts. Note that the dimensions of roundabouts may vary considerably within each category, depending on site-specific characteristics, including number of legs, approach angles, design vehicle requirements, and so on. Refer to Chapter 6 for more discussion of specific dimensions.

Exhibit B-1. Typical inscribed circle diameter ranges by roundabout category.

Site Category	Inscribed Circle Diameter Range
Mini-roundabout	13–25 m (45–80 ft)
Urban compact	25–30 m (80–100 ft)
Urban single lane	30–40 m (100–130 ft)
Urban double lane	45–55 m (150–180 ft)
Rural single lane	35–40 m (115–130 ft)
Rural double lane	55–60 m (180–200 ft)

The following pages show examples for each of the roundabout categories:

- Exhibit B-2: Typical mini-roundabout.
- Exhibit B-3: Typical urban compact roundabout.
- Exhibit B-4: Typical urban single-lane roundabout.
- Exhibit B-5: Typical urban double-lane roundabout.
- Exhibit B-6: Typical flared-entry roundabout.
- Exhibit B-7: Typical rural single-lane roundabout.
- Exhibit B-8: Typical rural double-lane roundabout.

Exhibit B-2. Example of a typical mini-roundabout.

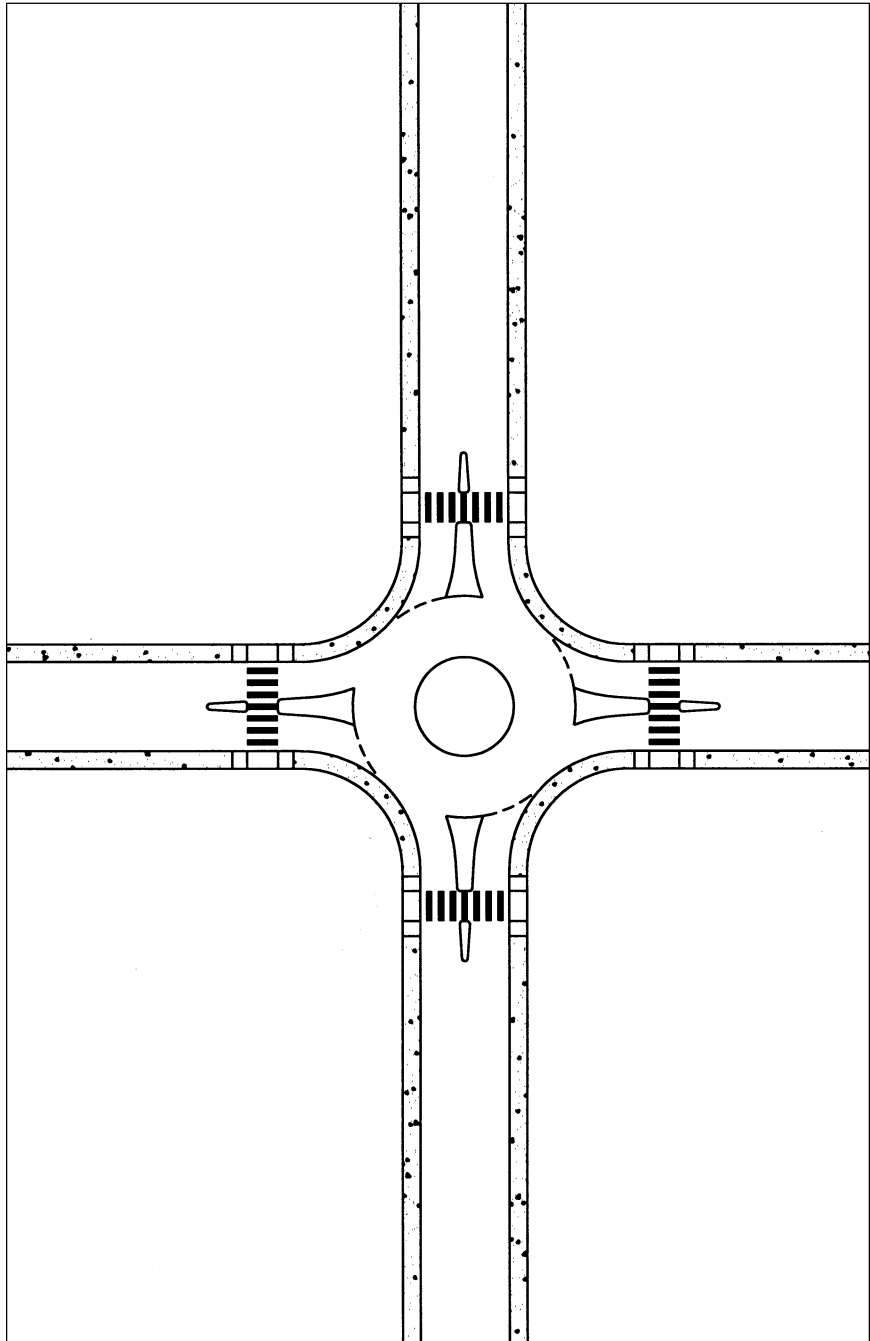

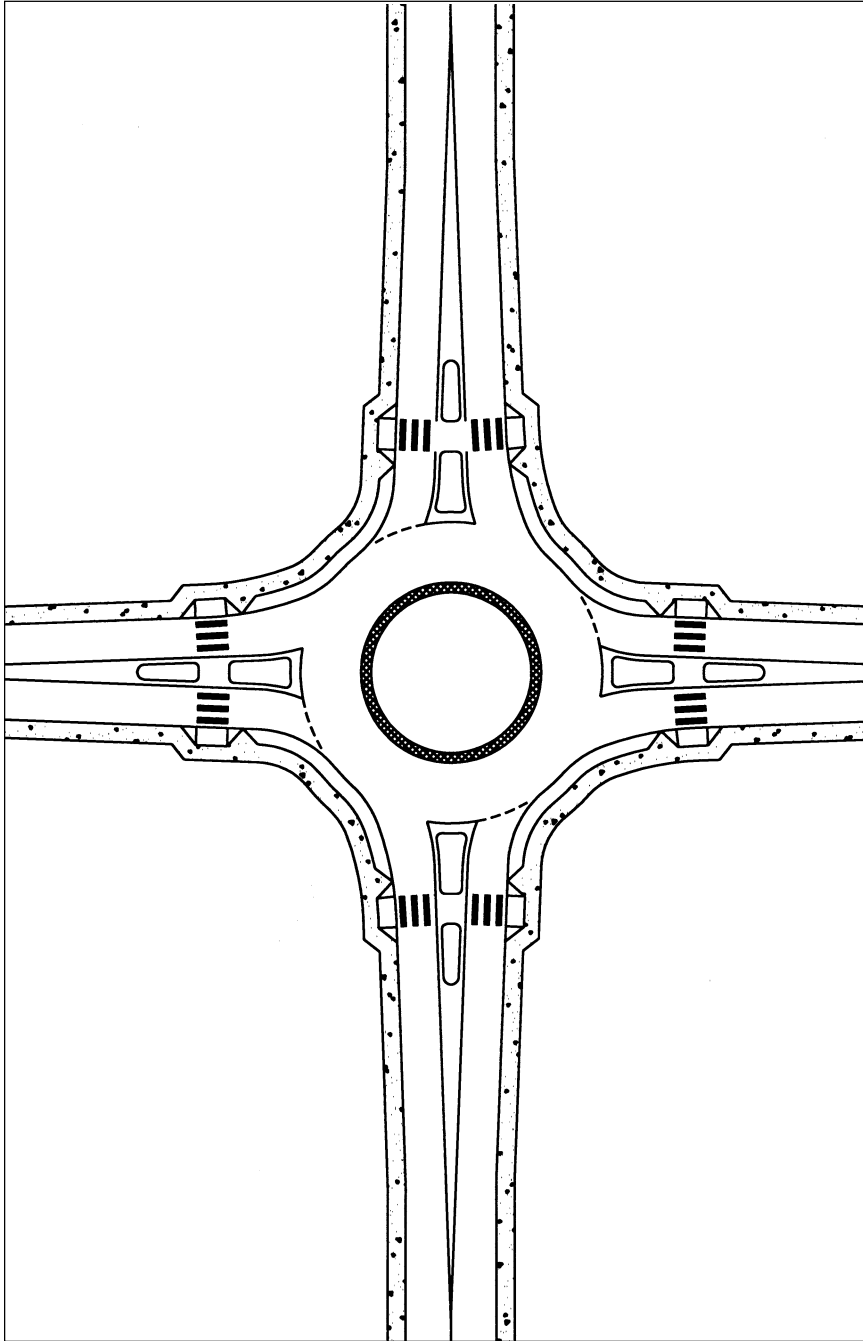
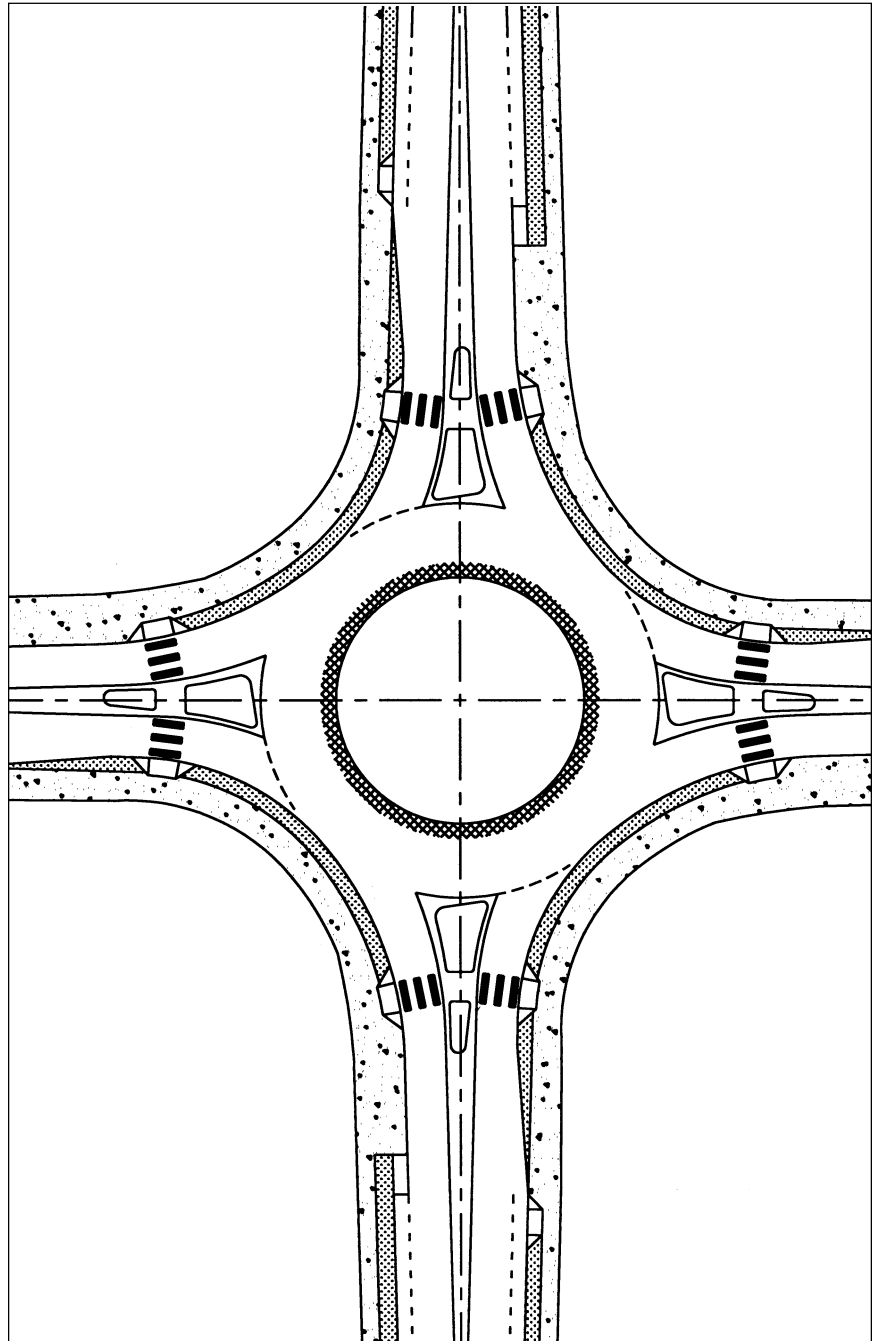

Exhibit B-3. Example of a typical urban compact roundabout.

Exhibit B-4. Example of a typical single-lane roundabout.



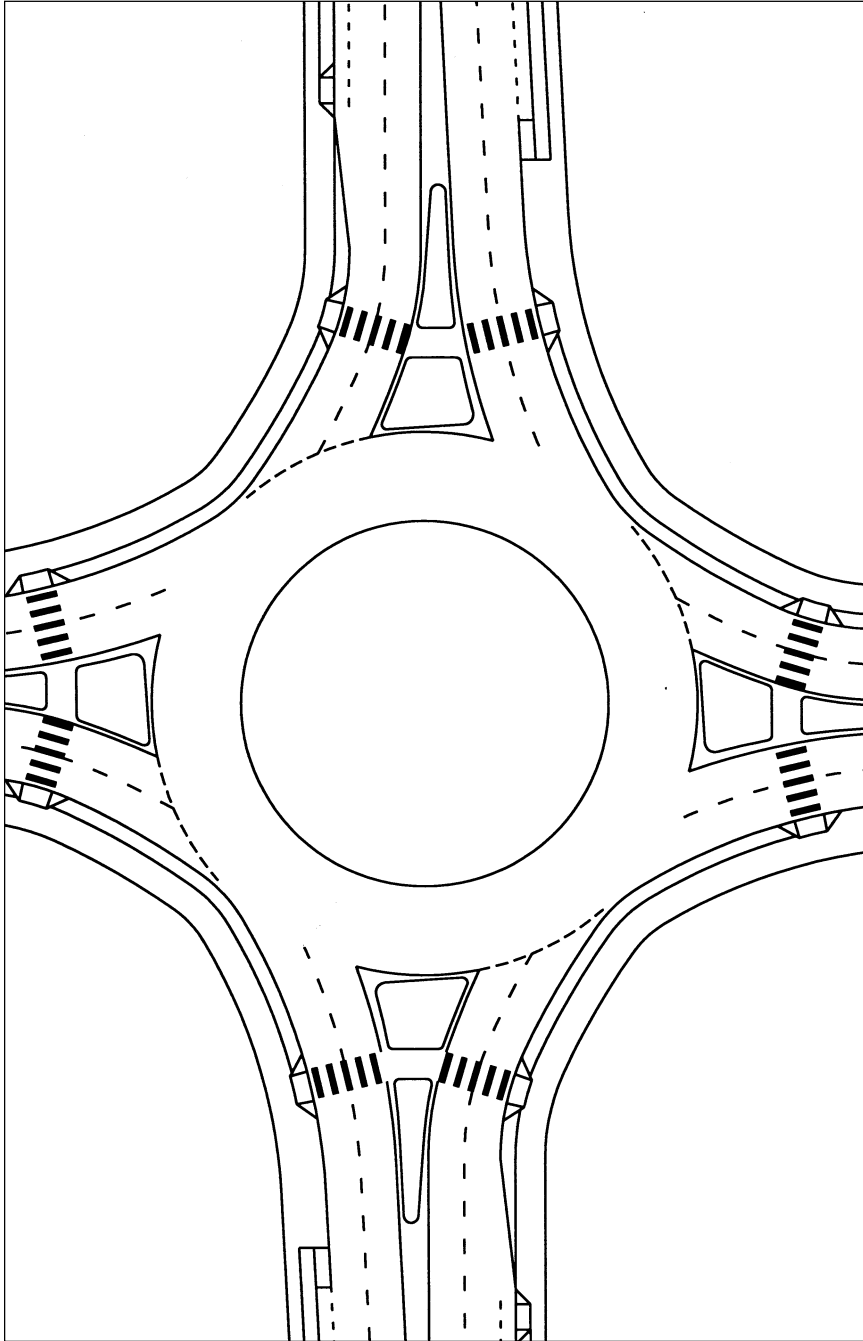
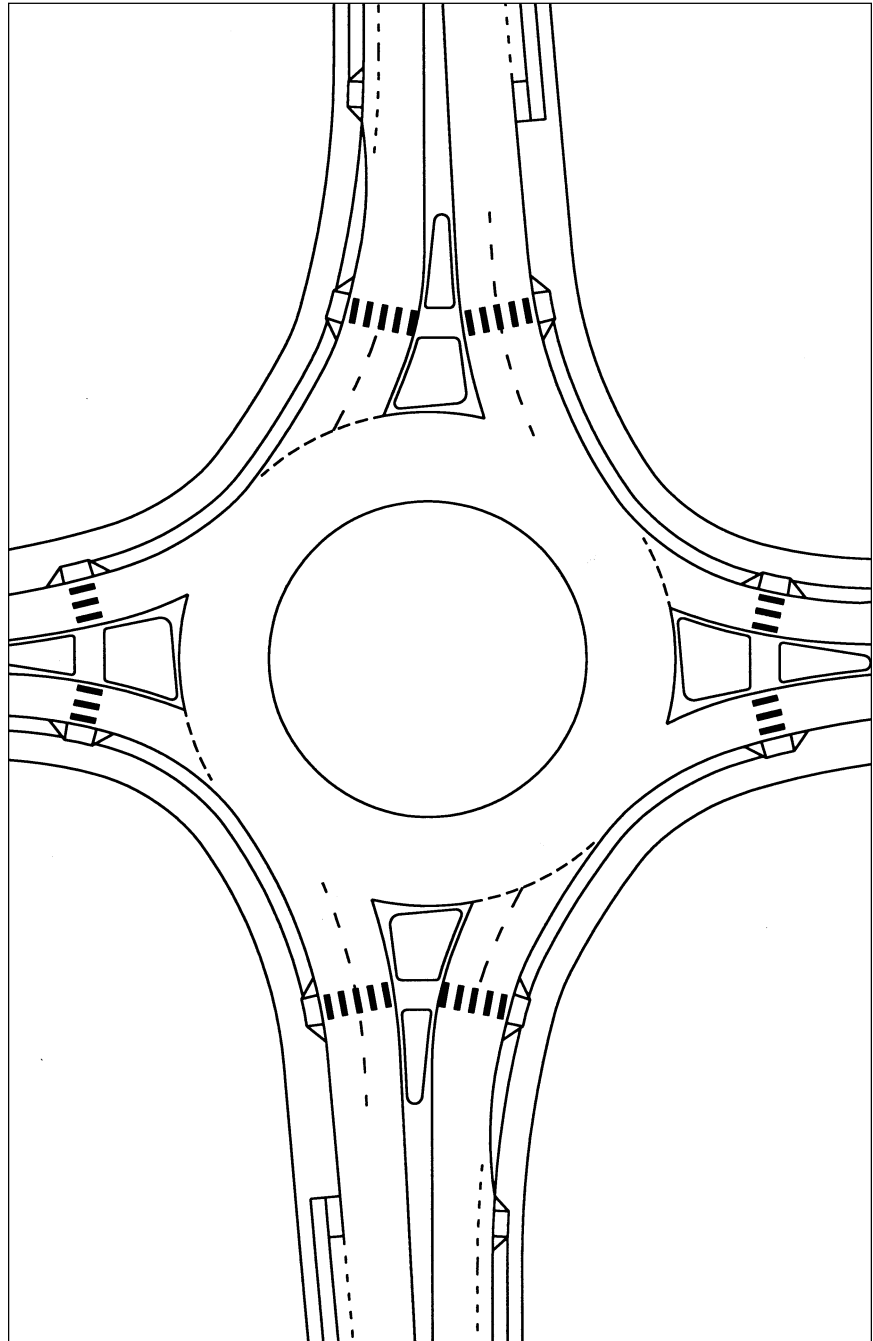

Exhibit B-5. Example of a typical urban double-lane roundabout.

Exhibit B-6. Example of a typical flared-entry roundabout.



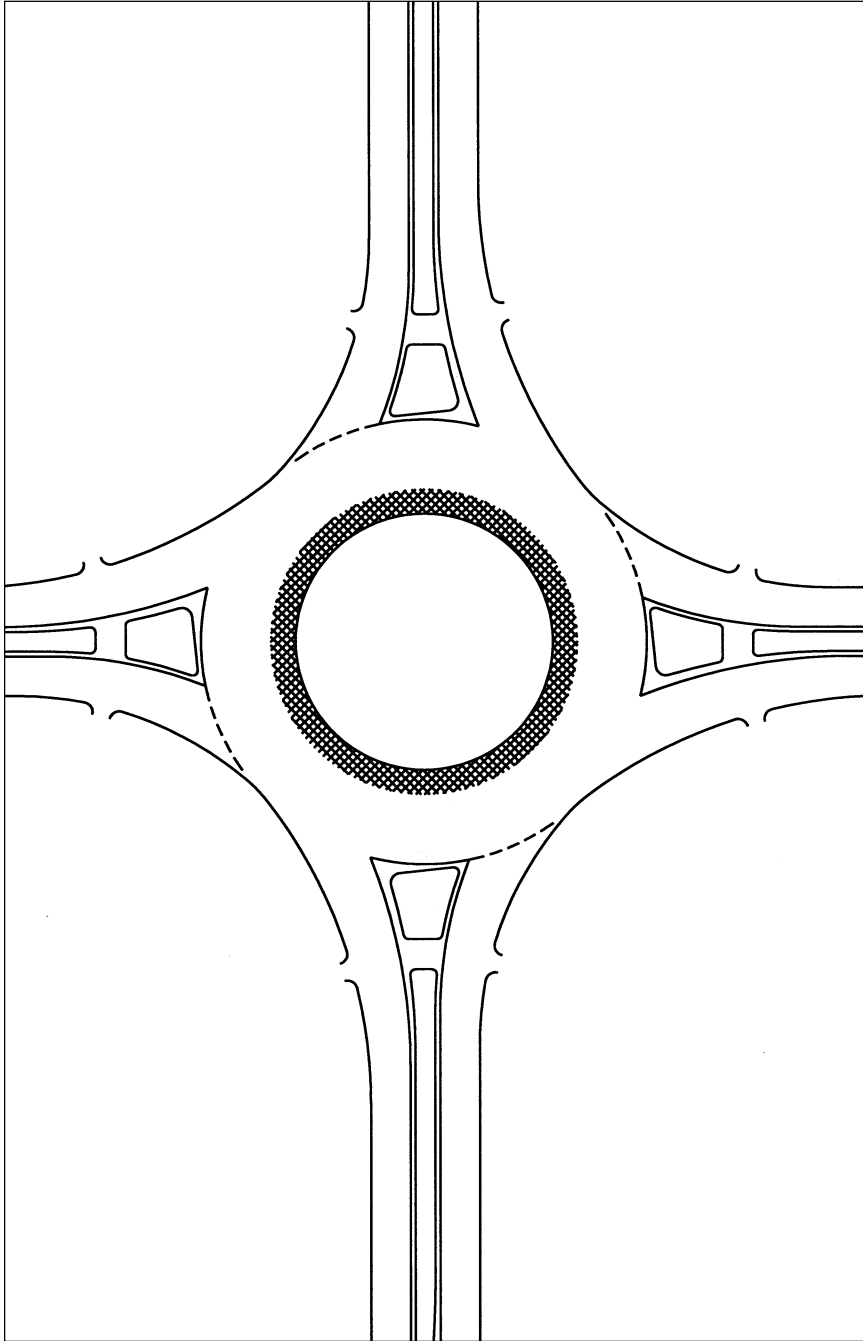
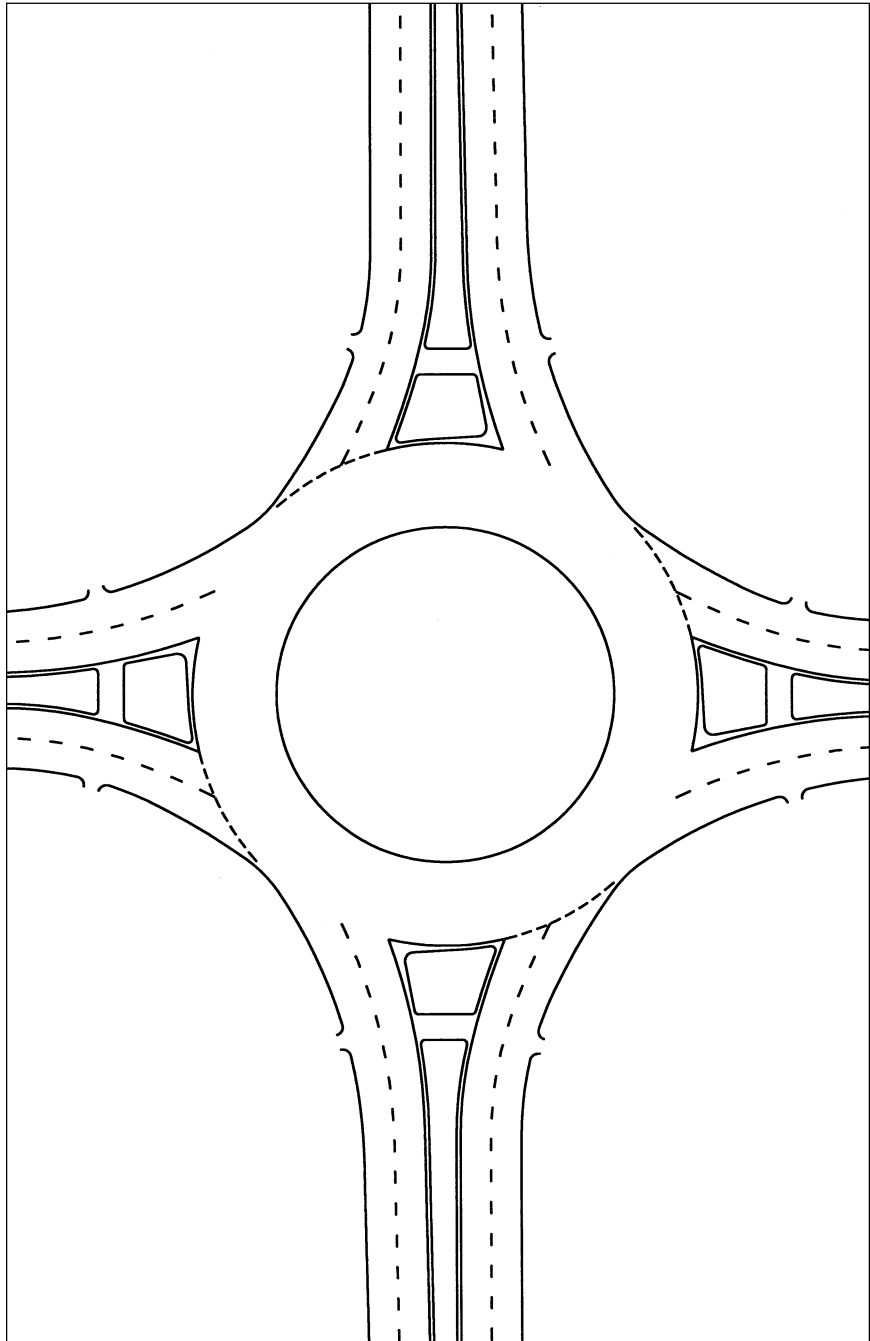

Exhibit B-7. Example of a typical rural single-lane roundabout.

Exhibit B-8. Example of a typical rural double-lane roundabout.



Appendix C MUTCD Recommendation

The purpose of this Appendix is to provide the rationale behind recommended deviations from the current (1988 edition) or proposed (2000 edition) *Manual on Uniform Traffic Control Devices* (MUTCD). The following devices are discussed:

- YIELD Sign
- Roundabout Ahead Sign

C.1 Yield Sign

The proposed use of the YIELD sign in the Guide is generally consistent with the MUTCD. However, the MUTCD contains language that generally discourages the use of YIELD signs for controlling the major flow at an intersection and the use of YIELD signs on more than one approach (MUTCD, §2B-8). This language predates the consideration of roundabouts and should be modified in the next edition of the MUTCD.

C.2 Roundabout Ahead Sign

As an alternative to the Circular Intersection sign, a Roundabout Ahead sign has been proposed. This sign, along with a supplemental advisory speed plate (W13-1), is shown in Exhibit C-1.



Exhibit C-1. Roundabout Ahead sign with advisory speed plate (W13-1).

This sign should be used on all approaches to a roundabout. The purpose of a Roundabout Ahead sign is to convey to a driver that the driver is approaching an intersection with the form of a roundabout. The intent of this sign is to be similar in function to the other intersection warning signs (e.g., CROSS ROAD (W2-1) signs), for example, which convey that the driver is approaching intersections of those forms. Unlike those signs, however, the Roundabout Ahead sign is recommended for all roundabouts, not just visually obscured locations.

C.2.1 Need

The 1988 edition of the MUTCD provides no sign related to roundabouts. The closest applicable sign is the YIELD AHEAD sign, either in word message or symbolic form (W3-2 or W3-2a, respectively). While this sign is necessary for indicating an upcoming traffic control device, it does not provide any information to the driver that the upcoming yield sign is for a roundabout. Driver behavior, lane assignments,

and driver expectation are much different for roundabouts than for traditional yield-controlled locations (typically low-volume streets or right-turn bypass lanes). Identification that a roundabout is upcoming is particularly important for multilane approaches so that drivers can anticipate and move into the proper lane in advance of the roundabout. Therefore, some indication that a driver is approaching a roundabout is essential, especially given the relative rarity of roundabouts in the United States.

The National Committee on Uniform Traffic Control Devices (NCUTCD) has adopted the Circular Intersection sign shown in Exhibit C-2, and this sign is being considered for adoption by FHWA.

Exhibit C-2. Circular Intersection sign.



C.2.2 Existing Practice

Due to the lack of a standard Roundabout Ahead sign, jurisdictions in the U.S. have experimented with a variety of warning signs, sometimes with multiple variations within the same jurisdiction. Examples of these are shown in Exhibit C-3. As can be seen from the figure, the lack of standardization from jurisdiction to jurisdiction is evident.

Exhibit C-3. Sample of existing Roundabout Ahead signs in United States.

- Bradenton Beach, FL (a)
- Mary Esther, FL (b)
- Mary Esther, FL (c)
- Lisbon, MD (d)
- Leeds, MD (e)
- Lothian, MD (f)
- Naples, FL (g)
- West Boca Raton, FL (h)





Exhibit C-3 (continued).

- (i) Santa Barbara, CA
- (j) Tallahassee, FL
- (k) Taneytown, MD
- (l) Tavares, FL
- (m) Vail, CO
- (n) West Vail, CO

International practice varies from country to country but is generally more consistent than current U.S. practice. Sign shapes and coloration vary depending on the standards of that country, but the one consistent feature is a simple ring of arrows, oriented to the direction of traffic flow. Examples from the United Kingdom and Australia are given in Exhibit C-4.



United Kingdom

Australia

Exhibit C-4. Sample of Roundabout Ahead signs used internationally.

C.2.3 Recommendation

Based on a review of existing signs in the U.S. and current international practice, a recommended Roundabout Ahead sign was developed, as presented previously in Exhibit C-1. This sign is similar in concept to those shown in (b), (c), and (j) of Exhibit C-3 and is shown fully dimensioned in Exhibit C-5. This sign has been developed based on the following criteria:

- The recommended sign is symbolic, consistent with current MUTCD practice.
- The recommended sign uses the internationally recognized circular ring of arrows to represent a roundabout and is almost an exact mirror image of the sign used in Australia (Exhibit C-4).
- The recommended sign gives advanced notice of the proper direction of circulation. The NCUTCD-adopted sign in Exhibit C-2 does not convey this information and could give the driver the incorrect impression that the circulatory roadway is bidirectional.

- The recommended sign can be used for roundabouts with any number of legs, including intersections with one-way approaches. Many of the signs in Exhibit C-3 and the NCUTCD-recommended sign in Exhibit C-2 are unique to four-leg roundabouts with legs at right angles and would be inappropriate for roundabouts with three or five legs, for example.
- The recommended sign can be supplemented by an advisory speed plate. An advisory speed plate would not be appropriate for a YIELD AHEAD sign because of the need for the driver to proceed only when clear.
- The recommended sign is simple with no extraneous or distracting elements to confuse a driver. Some of the signs in Exhibit C-3 are perhaps too complex for higher speed environments.
- Mini-roundabouts cannot be easily signed to show the proper direction of circulation. The recommended sign provides guidance to the driver as to the proper direction of circulation.

Exhibit C-5. Dimensions of Roundabout Ahead sign.

